

Installation and Operating Guide | Warranty

Model Numbers | R40W46, R40W46F, R45W46, R45W46F, R50W46, R57W46 | Projection TVs



RECORD YOUR MODEL NUMBER
(Now, while you can see it)

The model and serial number of your new TV are located on the back of the TV cabinet. For your future convenience, we suggest that you record those numbers here:

MODEL NO. _____

SERIAL NO. _____



CAUTION

RISK OF ELECTRIC SHOCK
DO NOT OPEN



WARNING:

TO REDUCE THE RISK OF ELECTRIC SHOCK DO NOT REMOVE COVER (OR BACK). NO USER SERVICEABLE PARTS INSIDE. REFER SERVICING TO QUALIFIED SERVICE PERSONNEL.



The lightning flash with arrowhead symbol, within an equilateral triangle, is intended to alert the user to the presence of uninsulated "dangerous voltage" within the product's enclosure that may be of sufficient magnitude to constitute a risk of electric shock to persons.



The exclamation point within an equilateral triangle is intended to alert the user to the presence of important operating and maintenance (servicing) instructions in the literature accompanying the appliance.

WARNING:

TO PREVENT FIRE OR SHOCK HAZARDS, DO NOT EXPOSE THIS PRODUCT TO RAIN OR MOISTURE.

POWER CORD POLARIZATION:

CAUTION: TO PREVENT ELECTRIC SHOCK, MATCH WIDE BLADE OF PLUG TO WIDE SLOT, FULLY INSERT.

ATTENTION: POUR ÉVITER LES CHOCS ÉLECTRIQUES, INTRODUIRE LA LAME LA PLUS LARGE DE LA FICHE DANS LA BORNE CORRESPONDANTE DE LA PRISE ET POUSSER JUSQU'AU FOND.

NOTE TO CABLE/TV INSTALLER:

This reminder is provided to call the cable TV system installer's attention to Article 820-40 of the National Electric Code (U.S.A.). The code provides guidelines for proper grounding and, in particular, specifies that the cable ground shall be connected to the grounding system of the building, as close to the point of the cable entry as practical.

REGULATORY INFORMATION:

This equipment has been tested and found to comply with the limits for a Class B digital device, pursuant to Part 15 of the FCC Rules. These limits are designed to provide reasonable protection against harmful interference when the equipment is operated in a residential installation. This equipment generates, uses and can radiate radio frequency energy and, if not installed and used in accordance with the instruction manual, may cause harmful interference to radio communications. However, there is no guarantee that interference will not occur in a particular installation. If this equipment does cause harmful interference to radio or television reception, which can be determined by turning the equipment off and on, the user is encouraged to try to correct the interference by one or more of the following measures:

- Reorient or relocate the receiving antenna.
- Increase the separation between the equipment and receiver.
- Connect the equipment into an outlet on a circuit different from that to which the receiver is connected.
- Consult the dealer or an experienced radio/TV technician for help.

Any changes or modifications not expressly approved by the party responsible for compliance could void the user's authority to operate the equipment.

CAUTION: Do not attempt to modify this product in any way without written authorization from Zenith Electronics Corporation. Unauthorized modification could void the user's authority to operate this product.

The responsible party for this product's compliance is :

Zenith Electronics Corporation, 2000 Millbrook Drive, Lincolnshire, IL 60069, USA 1-847-941-8000

IMPORTANT SAFETY INSTRUCTIONS

Important safeguards for you and your new product

Your product has been manufactured and tested with your safety in mind. However, improper use can result in potential electrical shock or fire hazards. To avoid defeating the safeguards that have been built into your new product, please read and observe the following safety points when installing and using your new product, and save them for future reference.

Observing the simple precautions discussed in this operating guide can help you get many years of enjoyment and safe operation that are built into your new product.

This product complies with all applicable U.S. Federal safety requirements, and those of the Canadian Standards Association.

1. Read Instructions

All the safety and operating instructions should be read before the product is operated.

2. Follow Instructions

All operating and use instructions should be followed.

3. Retain Instructions

The safety and operating instructions should be retained for future reference.

4. Heed Warnings

All warnings on the product and in the operating instructions should be adhered to.

5. Cleaning

Unplug this product from the wall outlet before cleaning. Do not use liquid cleaners or aerosol cleaners. Use a damp cloth for cleaning.

6. Water and Moisture

Do not use this product near water for example, near a bath tub, wash bowl, kitchen sink, or laundry tub, in a wet basement, or near a swimming pool.

7. Accessories, Carts, and Stands

Do not place this product on an unstable cart, stand, tripod, bracket, or table. The product may fall, causing serious injury to a child or adult, and serious damage to the product. Use only with a cart, stand, tripod, bracket, or table recommended by the manufacturer, or sold with the product. Any mounting of the product should follow the manufacturer's instructions, and should use a mounting accessory recommended by the manufacturer.

8. Transporting Product

A product and cart combination should be moved with care. Quick stops, excessive force, and uneven surfaces may cause the product and cart combination to overturn.

9. Attachments

Do not use attachments not recommended by the product manufacturer as they may cause hazards.

10. Ventilation

Slots and openings in the cabinet are provided for ventilation and to ensure reliable operation of the product and to protect it from overheating, and these openings must not be blocked or covered. The openings should never be blocked by placing the product on a bed, sofa, rug, or other similar surface. This product should not be placed in a built-in installation such as a bookcase or rack unless proper ventilation is provided or the manufacturer's instructions have been adhered to.

11. Power Sources

This product should be operated only from the type of power source indicated on the marking label. If you are not sure of the type of power supply to your home, consult your product dealer or local power company. For products intended to operate from battery power, or other sources, refer to the operating instructions.

12. Line-Cord Polarization

This product is equipped with a polarized alternating-current line plug (a plug having one blade wider than the other). This plug will fit into the power outlet only one way. This is a safety feature. If you are unable to insert the plug fully into the outlet, try reversing the plug. If the plug should still fail to fit, contact your electrician to replace your obsolete outlet. Do not defeat the safety purpose of the polarized plug.

13. Power-Cord Protection

Power-supply cords should be routed so that they are not likely to be walked on or pinched by items placed upon or against them, paying particular attention to cords at plugs, convenience receptacles, and the point where they exit from the product.



PORTABLE CART WARNING

(Continued on next page)

IMPORTANT SAFETY INSTRUCTIONS

(Continued from previous page)

14. Outdoor Antenna Grounding

If an outside antenna or cable system is connected to the product, be sure the antenna or cable system is grounded so as to provide some protection against voltage surges and built-up static charges. Article 810 of the National Electrical Code (U.S.A.), ANSI/ NFPA 70 provides information with regard to proper grounding of the mast and supporting structure, grounding of the lead-in wire to an antenna discharge unit, size of grounding conductors, location of antenna-discharge unit, connection to grounding electrodes, and requirements for the grounding electrode.

Example of Grounding According to National Electrical Code Instructions

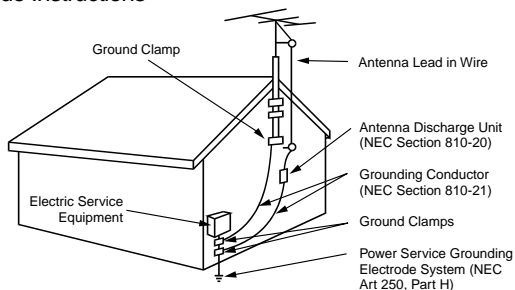

NEC- National Electrical Code

15. Lightning

For added protection for this product (receiver) during a lightning storm, or when it is left unattended and unused for long periods of time, unplug it from the wall outlet and disconnect the antenna or cable system. This will prevent damage to the product due to lightning and power-line surges.

16. Power Lines

An outside antenna system should not be located in the vicinity of overhead power lines or other electric light or power circuits, or where it can fall into such power lines or circuits. When installing an outside antenna system, extreme care should be taken to keep from touching such power lines or circuits as contact with them might be fatal.

17. Overloading

Do not overload wall outlets and extension cords as this can result in a risk of fire or electric shock.

18. Object and Liquid Entry

Never push objects of any kind into this product through openings as they may touch dangerous voltage points or short-out parts that could result in a fire or electric shock. Never spill liquid of any kind on the product.

19. Servicing

Do not attempt to service this product yourself as opening or removing covers may expose you to dangerous voltage or other hazards. Refer all servicing to qualified service personnel.

20. Damage Requiring Service

Unplug this product from the wall outlet and refer servicing to qualified service personnel under the following conditions:

- If the power-supply cord or plug is damaged.
- If liquid has been spilled, or objects have fallen into the product.
- If the product has been exposed to rain or water.
- If the product does not operate normally by following the operating instructions. Adjust only those controls that are covered by the operating instructions as an improper adjustment of other controls may result in damage and will often require extensive work by a qualified technician to restore the product to its normal operation.
- If the product has been dropped or the cabinet has been damaged.
- If the product exhibits a distinct change in performance.

21. Replacement Parts

When replacement parts are required, be sure the service technician has used replacement parts specified by the manufacturer or have the same characteristics as the original part. Unauthorized substitutions may result in fire, electric shock, or other hazards.

22. Safety Check

Upon completion of any service or repairs to this product, ask the service technician to perform safety checks to determine that the product is in proper operating condition.

23. Wall or Ceiling Mounting

The product should be mounted to a wall or ceiling only as recommended by the manufacturer.

24. Heat

The product should be situated away from heat sources such as radiators, heat registers, stoves, or other products (including amplifiers) that produce heat.

CONTENTS

Safety Warnings	2
Important Safety Instructions	3
Remote Control Key Functions	6
Basic TV Setup and Operation	9
Turning the TV On/Off	9
Selecting a Language for the Onscreen Menus. ...	9
Selecting the Main Screen Input Source	9
Channel Search	10
Memorizing the Channels with EZ Scan	10
Adding/Deleting Channels with MANUAL PROGRAM	11
Tuning Channels	11
Adjusting the Sound Level	11
Features	12
Clock Setup: Auto/Manual	12
Off Timer/ On Timer Setup	13
Auto Off Setup	13
Sleep Timer Setup	14
Key Lock Setup	14
Fine Tuning Adjustment	15
Signal Reception Booster	15
Favorite Channel Memory	15
Picture Format Selection	16
Auto Move	16
Picture Setup	17
EZ Video Setup	17
DRP (Digital Reality Picture)	17
Cinema Mode Setup	17
VM (Velocity Modulation) Setup	18
ACC (Auto Color Control) Setup	18
User Picture Appearance Adjustments	18
Color Convergence Adjustment	19
Auto Convergence Adjustment	19
Sound Setup	20
Stereo/SAP Broadcasts Setup	20
EZ Audio Options	20
AVL (Auto Volume Leveler)	21
TV Speaker On/Off	21
Adjusting Balance, Treble, Bass	21
PIP (Picture-in-Picture) / Twin Picture.	22
Watching PIP (Picture-in-Picture)	22
Selecting Viewing Sources (In PIP and Twin picture modes)	22
Moving the Sub picture (In PIP mode)	22
POP (Picture-Out-Picture): Channel Search and Display)	23
Still Picture (Freeze)	23
Swapping Main/Sub Pictures	23
Closed Captions	24
Using Closed Captions	24
Captions On, Off, EZ mute Setup	25
Selecting Caption/Text Mode	25
Parental Control Overview	26
Blocking Scheme Setup	27
Antenna Connections	28
External Equipment Connection and Viewing Setup	29
Programming the Remote to operate other devices	33
Programming Codes	34
Maintenance	37
Product Specifications	38
Troubleshooting Checklist	39
Your Zenith Limited Warranty	Back cover

Setup Checklist

Step 1

Connect TV to all sources and external equipment:
See pages 28-32

Step 2

Do a channel search: find available channels in your area:
See pages 10-11

Step 3

Set up the individual features, picture, and sound to
your personal preference:
See appropriate pages above

Remote Control Key Functions

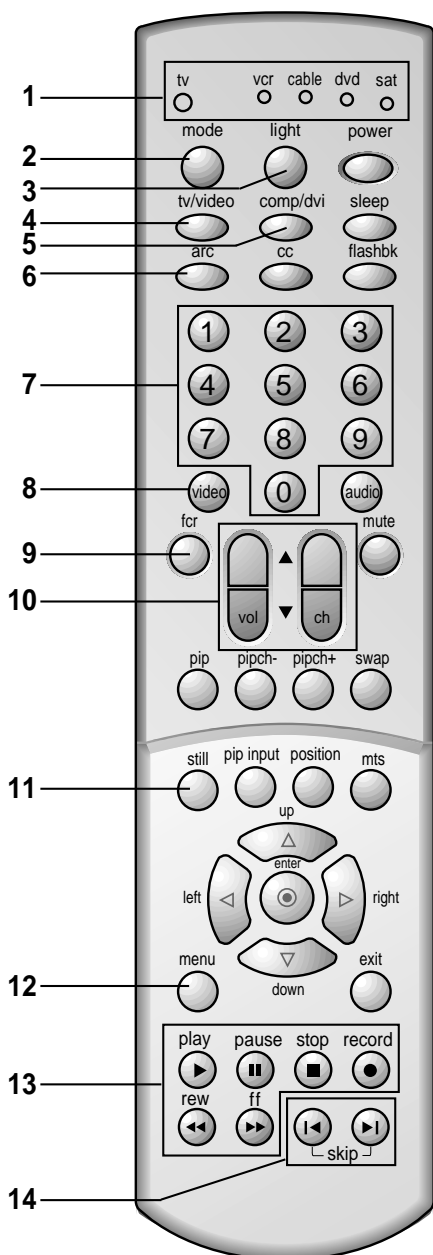

1. MODE INDICATOR LIGHTS

Show active remote mode every time any button is pressed.

2. MODE

Selects the remote operating mode: TV, VCR, Cable Box, DVD and Satellite. Select other remote modes, for the remote to operate external devices.

3. LIGHT

Illuminates the remote control keys.

4. TV/VIDEO

Selects TV, VIDEO, COMPONENT, or DVI mode.

5. COMP/DVI

Selects COMPONENT or DVI mode.

6. ARC

Selects 4:3, 16:9, Horizon, Zoom 1, or Zoom 2 picture formats.

7. NUMBER BUTTONS

Direct channel selection.

8. VIDEO

Selects factory preset picture settings: **Clear**, **Optimum**, **Soft**, or **User**.

9. FCR (Favorite Channel Review)

Selects favorite channels. Refer to "**Favorite channel memory**".

10. CHANNEL UP/DOWN

- Selects the desired channel.
- Selects the desired menu option when menu is displayed on the screen.

VOLUME UP/DOWN

- Increases or decreases sound level.
- Enters or adjusts the selected menu when menu is displayed on the screen.

11. STILL

Freezes the sub picture in PIP mode.
Freezes the currently-viewed picture.

12. MENU

Displays on-screen menus.

13. VCR BUTTONS

Control some video cassette recorders.

14. SKIP Left/Right

Playing CDs: Selects previous/next song.
Playing DVDs: Selects previous/next movie chapter.

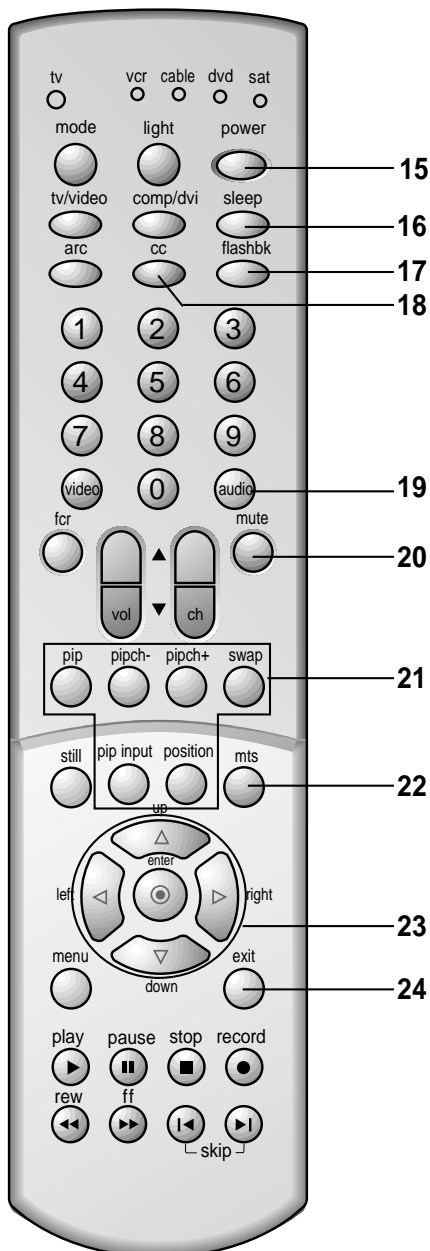

15. POWER (or ON/OFF)

Refer to "Turning the TV on/off".

16. SLEEP (Sleep Timer)

Sets turn off time.

17. FLASHBK

Returns to the previous channel.

18. CC

Selects the CAPTIONS: **On**, **EZ Mute**, or **Off**.

19. AUDIO

Selects the sound appropriate for the program's character; **Virtual**, **Flat**, **Music**, **Movie**, **Sports** or **User**.

20. MUTE (Two Levels)

Reduce sound to half volume or mute the sound entirely.

21. PIP (Picture-in-Picture)

PIP

Selects the PIP mode, twin picture window, or POP mode.

PIPCH +/-

Selects the sub picture channel.

SWAP

Switches the main and sub pictures.

PIP INPUT

Selects the input signal for the sub picture.

POSITION

Moves the sub picture to another corner of the main picture.

22. MTS BUTTON

Selects MTS sound: **Mono**, **Stereo**, or **SAP**.

23. UP▲/ DOWN▼/ LEFT◀/ RIGHT▶/ ENTER⊙

- Navigates the on-screen menus to adjust the TV settings and preferences.
- Displays current TV mode (Remote control only).

24. EXIT

Clears all on-screen displays and returns to TV viewing from any menu.

25. STAND BY INDICATOR (⏻)

Illuminates brightly when the TV is in standby mode. Dims when the TV is switched on.

Remote Control Key Functions / TV Setup

26. REMOTE CONTROL SENSOR

27. LED (Light Emitting Diodes) Displays

LEDs light when source is selected or feature is present.

28. INDEX

Switches LED Display on or off.

Installing Batteries in the Remote Control

- Remove the battery compartment cover on the back side and insert the batteries with correct polarity.
- Install two 1.5V, AA batteries. Don't mix used and new batteries.

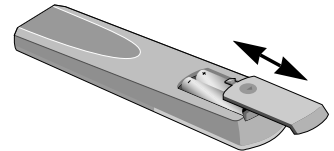

Front Panel Controls

This is a simplified representation of front panel.

* R40W46, R40W46F, R45W46, R45W46F

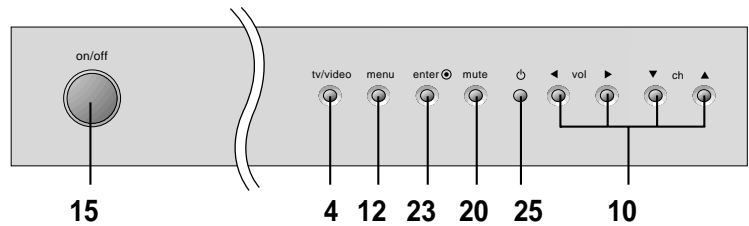
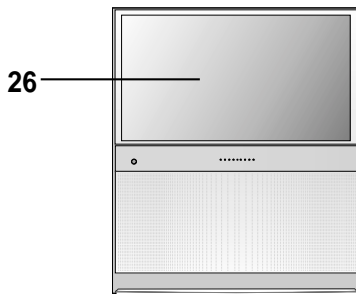

* R50W46, R57W46

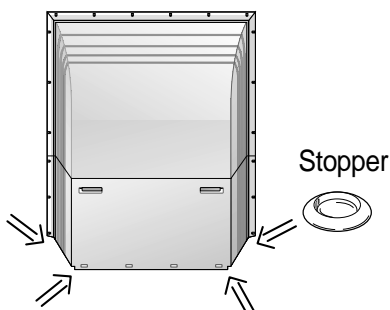
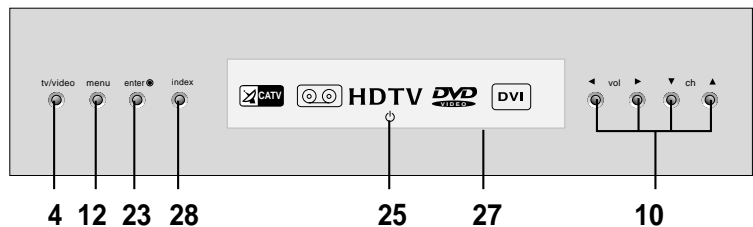
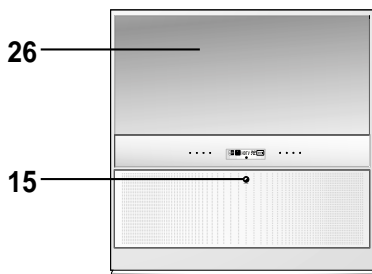

Securing TV Position

- Position the TV and prevent it from being moved, by placing the 4 stoppers under the roller casters on the bottom of the TV.
- Casters (on TV bottom)
Use to turn and move the TV easily.

Basic TV Setup and Operation

Before operating your TV, make sure the TV has been connected to an antenna or cable system and the TV is plugged into a power outlet.

Turning the TV On/Off

The set switches to standby mode and the standby indicator lights red. To switch the TV on from standby mode, press the on/off, tv/video, ch▲/▼ button on the set or tv/video, ch▲/▼, comp/dvi, power or number button on the remote control.

A channel number will be displayed on the screen. The on-screen display will disappear after a few seconds.

Press the **power** button on the remote control or the set. The TV reverts to standby mode.

Selecting a Language for the Onscreen Menus

1. Press the **menu** button and then use ▲ / ▼ button to select the Special menu.
2. Press the ► and then use ▲/▼ button to select **Language**.
3. Press the ► and then use ▲ / ▼ button to select the desired language.

From this point on, the menus will appear in the language you selected.

4. Press the **exit** button to return to TV viewing.

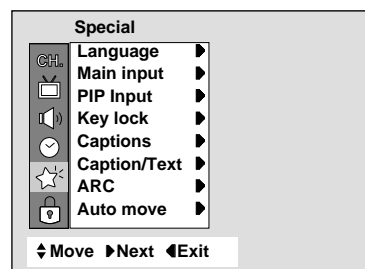

Selecting a Source for the Main Screen Picture

Changes the picture source for the main screen so you can watch your off-air TV, cable TV, VCR, DVD, or any other devices that are connected to your TV.

1. Press the **menu** button and then use ▲ / ▼ button to select the Special menu.
2. Press the ► and then use ▲/▼ button to select **Main input**.
3. Press the ► and then use ▲ / ▼ button to select **TV, Video 1, Video 2, Video 3, Video 4, Component 1, Component 2** or **DVI**.

4. Press the **exit** button to return to TV viewing.

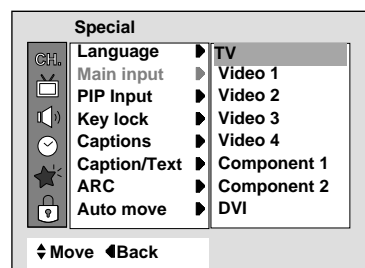

Channel Search

Channel Search memorizes all the active channels in your area. You must do a channel search before you can use the TV.

There two ways of memorizing channels. You can use either, **EZ Scan** or **Manual Program..**

In **EZ Scan**, the TV memorizes the channels in ascending numerical order.

You can also add or delete channels manually.

Finding Channels with EZ Scan

EZ Scan searches and memorizes all the active channels in your area. Select the desired channel with the ▲/▼ buttons.

1. Press the **menu** button and then use ▲ / ▼ button to select the Channel menu.
2. Press the ► and then use ▲/▼ button to select **EZ Scan**.
3. Press the ► button. The EZ Scan function starts.

If you want to stop EZ Scan, press the **enter** (⊙) button.

Only the channels searched up to that time are memorized.

Notes

- EZ Scan stores all available channels regardless of signal (RF, Cable).
- If over-the-air and Cable TV channels are duplicated, use the number buttons (0 ~ 9) to change channels for:

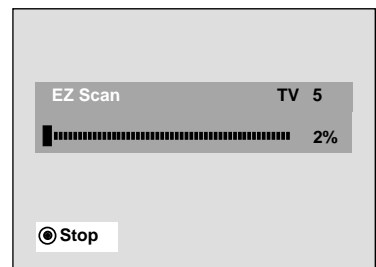
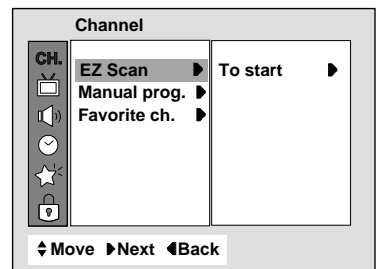
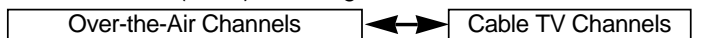

Adding/Deleting Channels with Manual Program

1. Press the **menu** button and then use **▲ / ▼** button to select the Channel menu.
2. Press the **▶** and then use **▲/▼** button to select **Manual prog.**.
3. Press the **▶** and then use **▲/▼** button to select **Channel**.
4. Press the **▶** and then use **▲/▼** button to select the channel number you want to memorize or erase.
5. Press the **◀** button and then use **▲/▼** button to select **Memory**.
6. Press the **▶** and then use **▲/▼** button to select **On** or **Off**.
7. Press the **◀** button and then use **▲/▼** button to select **Ch.name**. You can make a channel name.
8. Press the **▶** and then use **◀/▶** button to select a word position and then **▲/▼** button to enter alphabet **A** to **Z**, **a** to **z**, number **0** to **9** and blank.
9. Repeat process 3 to 8 to memorize or erase another channels.
10. Press the **exit** button to return to TV viewing.

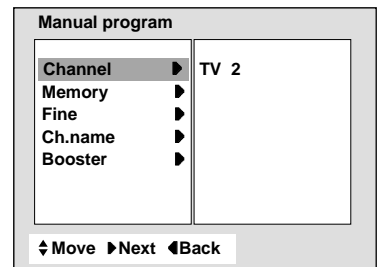
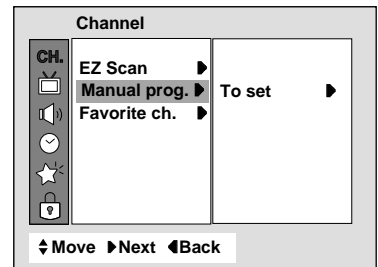

Tuning Channels

Use the **ch ▲ / ▼** button to easily select the next higher or lower channel. Or, use the **NUMBER** buttons to directly select the desired channel.

Adjusting the Sound Level

Use the **vol ▲** button to increase the volume level or **vol ▼** button to decrease the volume level.

If you press the **mute** button on the remote control once, the sound is reduce to the half level of original volume level. When pressing the **mute** button on the remote control again, the sound is muted. At this time, the word **Mute** is displayed.

Using Mute is convenient if you need to answer a telephone call.

To restore the muted sound, press the **mute** button on the remote control again or **vol ▲/▼** button again.

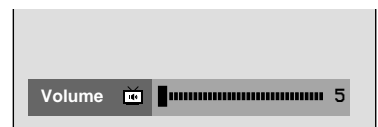

Clock Setup: Auto/Manual

Before using the on/off timer features, set the current time on the clock.

Auto Clock Setup

The time is set automatically from a PBS broadcast signal. The PBS channel signal includes information for the correct time and daylight saving time.

1. Press the **menu** button and then use **▲ / ▼** button to select the Timer menu.
2. Press the **▶** and then use **▲ / ▼** button to select **Clock**.
3. Press the **▶** and then use **▲ / ▼** button to select **Auto**.
4. Press the **▶** button and then use the **▲ / ▼** button to select the **Time zone**.
5. Press the **▶** button and then use the **▲ / ▼** button to select **E.S.T.** (Eastern Standard Time), **C.S.T.** (Central Standard Time), **M.S.T.** (Mountain Standard Time), **P.S.T.** (Pacific Standard Time), **Alaska**, or **Hawaii**.
6. Press the **◀** button and then use the **▲ / ▼** button to select **PBS CH.**
7. Press the **▶** button and then use the **▲ / ▼** button to set PBS channel.
8. Press the **◀** button and then use the **▲ / ▼** button to select **D.S.T.** (Daylight Savings Time).
9. Press the **▶** button and then use the **▲ / ▼** button to set **D.S.T.** (Daylight Savings Time) **Auto**, **On**, or **Off** depending on whether or not your viewing area observes Daylight Savings Time.
10. Press the **exit** button to return to TV viewing.

Manual Clock Setup

1. Press the **menu** button and then use **▲ / ▼** button to select the Timer menu.
2. Press the **▶** and then use **▲ / ▼** button to select **Clock**.
3. Press the **▶** button and then use the **▲ / ▼** button to select **Manual**.
4. Press the **▶** button and then use the **▲ / ▼** button to set the hours.
5. Press the **▶** button and then use the **▲ / ▼** button to set the minutes.
6. Press the **exit** button to return to TV viewing.

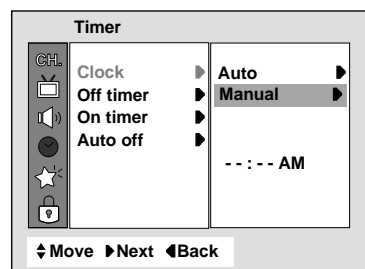
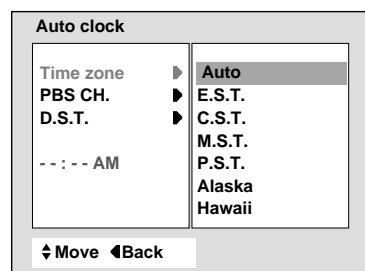
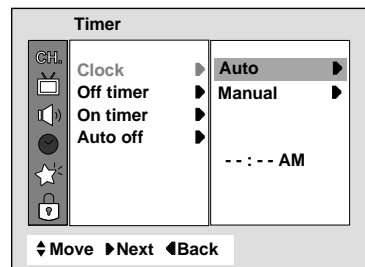

Off Timer/On Timer Setup

Off Timer automatically switches the TV to standby mode at the preset time.

On Timer automatically turns the TV on at the preset time and tunes to the specified channel.

1. Press the **menu** button and then use ▲ / ▼ button to select the Timer menu.
2. Press the ► and then use ▲ / ▼ button to select **Off timer** or **On timer**.
3. Press the ► and then use ▲ / ▼ button to set the hour.
4. Press the ► and then use ▲ / ▼ button to set the minute.
5. **For only On timer function:** Press the ► and then use ▲ / ▼ button to set the desired channel.
Press the ► and then use ▲ / ▼ button to set the volume level at turn on.
6. **Run/Hold** is used to activate or deactivate preset on/off timers.
Press the ► and then use ▲ / ▼ button to select **Hold** or **Run**.
7. Press the **exit** button to return to TV viewing.

Notes

- Two hours after the set is turned on by the on timer function, it will automatically revert back to standby mode unless a button has been pressed.
- This function works only in standby mode.
- If the same time is set for the on time and off time, only the off time operates.

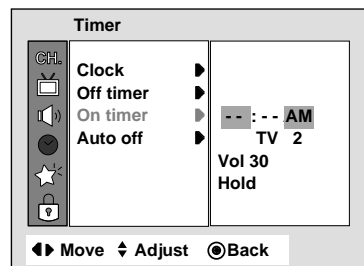

Auto Off Setup

If an input signal is not present, the TV is automatically switched to standby mode after 10 minutes.

1. Press the **menu** button and then use ▲ / ▼ button to select the Timer menu.
2. Press the ► and then use ▲ / ▼ button to select **Auto off**.
3. Press the ► and then use ▲ / ▼ button to select **On** or **Off**.
4. Press the **exit** button to return to TV viewing.

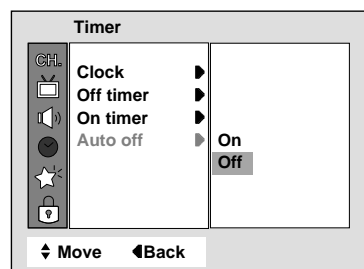

Sleep Timer Setup

You don't have to remember to switch the TV to standby mode before you go to sleep. The Sleep Timer automatically turns the TV off after the preset sleep time expires.

Use the **sleep** button to select the desired sleep time.

Each time you press this button, preset sleep time settings are displayed one by one as shown below. The Sleep Timer begins to count down from the number of minutes selected.

▶ --- ▶ 10 ▶ 20 ▶ 30 ▶ 60 ▶ 90 ▶ 120 ▶ 180 ▶ 240



Notes

- After a few seconds, the desired sleep time setting will disappear and the TV turn-off function will operate automatically.
- To view the remaining sleep time, press the **sleep** button once and the remaining sleep time will be displayed.
- To cancel the Sleep Timer, select the --- setting with **sleep** button.

Key Lock Setup

The TV can be set up so that it can only be operated by the remote control. This feature can be used to prevent unauthorized viewing.

1. Press the **menu** button and then use ▲ / ▼ button to select the special menu.
2. Press the ▶ and then use ▲/▼ button to select **Key lock**.
3. Press the ▶ and then ▲/▼ button to select **On** or **Off**.
4. Press the **exit** button to return to TV viewing.

Notes

- With key lock set to on, the display **Key lock** appears on the screen if any button on the front panel is pressed while viewing the TV.
- This TV is programmed to remember which option it was last set to when you switch the TV on from standby mode.

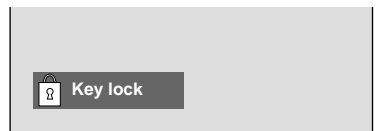
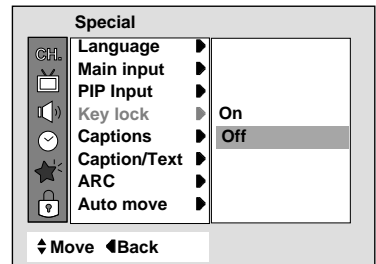

Fine Tuning Adjustment

Use Fine Tuning is to stabilize the picture's condition if it is poor, for example, a horizontal stripe, twisted picture or no color in broadcast.

1. Press the **menu** button and then use ▲ / ▼ button to select the Channel menu.
2. Press the ► and then use ▲/▼ button to select **Manual prog.**
3. Press the ► and then use ▲/▼ button to select **Fine**.
4. Press the ► and then use ◀ / ▶ button to adjust the picture appearance to your preference.
5. Press the **exit** button to return to TV viewing.

Notes :

- To release the memorized fine tuning, reprogram the fine-tuned channel with EZ Scan or Manual Program.
- If a finely-tuned channel is memorized, the color of the channel number changes to yellow.

Signal Reception Booster

If TV signal reception is poor because you are in a fringe area, set **Booster** to **On**. If the picture condition is good, do not set **Booster** to **On**.

1. Press the **menu** button and then use ▲ / ▼ button to select the Channel menu.
2. Press the ► and then use ▲/▼ button to select **Manual prog.**
3. Press the ► and then use ▲/▼ button to select **Booster**.
4. Press the ► and then use ▲/▼ button to select **On** or **Off**.
5. Press the ◀ button to exit.

Note : Adjustment for one channel don't affect the adjustment of other channels. Set booster to on or off for each channel separately.

Favorite Channel Memory

Favorite channel memory is a convenient feature that lets you quickly view up to eight channels of your choice without having to wait for the TV to tune in all of the in-between channels.

1. Press the **menu** button and then use ▲ / ▼ button to select the Channel menu.
2. Press the ► and then use ▲/▼ button to select **Favorite ch.**
3. Press the ► and then use ▲/▼ button to select a favorite channel position.
4. Use the ◀/▶ button to select the desired channel number.
5. Repeat steps 3 to 4.
6. Press the **exit** button to return to TV viewing.

To select a favorite channel, press the **fcr** (Favorite Channel Review) button repeatedly. The eight favorite channels appear on the screen one by one.

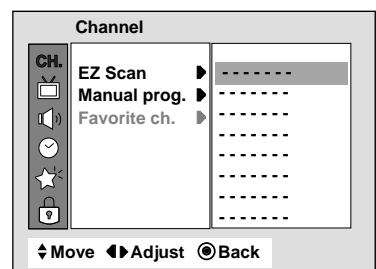
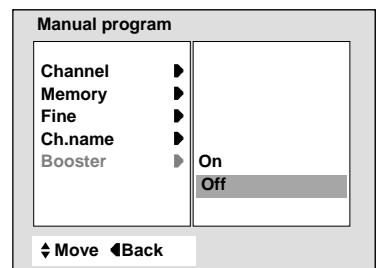
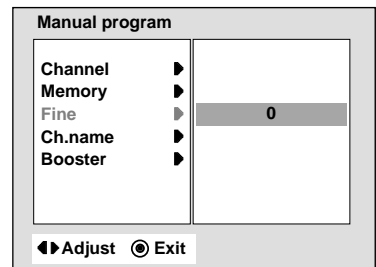
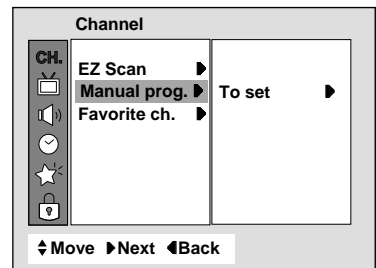

Picture Format Selection

You can select 5 picture formats are available.

Press the **ARC** button repeatedly to select your desired picture format. Each time you press the button, the picture format is changed in the order of **4:3**, **16:9**, **Horizon**, **Zoom 1**, and **Zoom 2**.

Using the arc Button

1. Repeatedly press the **arc** button to select **4:3**, **16:9**, **Horizon**, **Zoom 1** or **Zoom 2**.
2. Press the **enter** (Ⓞ) button to exit.

Using the Menu

1. Press the **menu** button and then use **▲ / ▼** button to select the Special menu.
2. Press the **▶** and then use **▲ / ▼** button to select **ARC**.
3. Press the **▶** and then **▲ / ▼** button to select **4:3**, **16:9**, **Horizon**, **Zoom 1** or **Zoom 2**.
4. Press the **exit** button to return to TV viewing.

Note : This function is not available in Twin picture or Component 1080i mode.

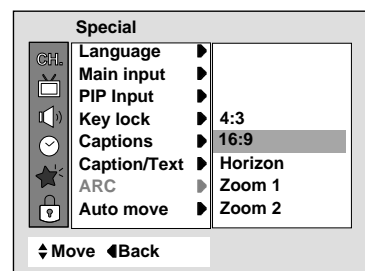

Auto Move

Auto move may help prevent a ghost image from appearing on the screen. In 4:3 aspect ratio, the picture will move right/left about 5mm every 2 hours. In twin picture mode, the picture will move up/down about 5mm every 2 hours.

1. Press the **menu** button and then use **▲ / ▼** button to select the Special menu.
2. Press the **▶** and then use **▲ / ▼** button to select **Auto move**.
3. Press the **▶** and then use **▲ / ▼** button to select **On** or **Off**.
4. Press the **exit** button to return to TV viewing.

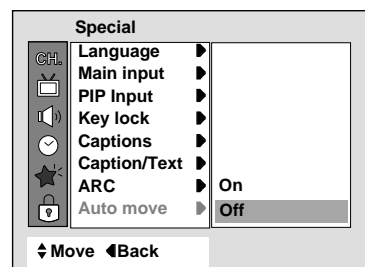

Picture Setup

EZ Video Setup

For optimum picture quality, use the factory preset picture modes.

EZ Video set up using the video button

1. Press the **video** button repeatedly to select **Clear**, **Optimum**, **Soft**, or **User**.
2. Press the **enter** (Ⓞ) button to return to TV viewing.



EZ Video set up using the Picture menu

1. Press the **menu** button and then use **▲ / ▼** button to select the Picture menu.
2. Press the **▶** and then use **▲ / ▼** button to select **EZ Video**.
3. Press the **▶** and then use **▲ / ▼** button to select **Clear**, **Optimum**, **Soft**, or **User**.
4. Press the **exit** button to return to TV viewing.

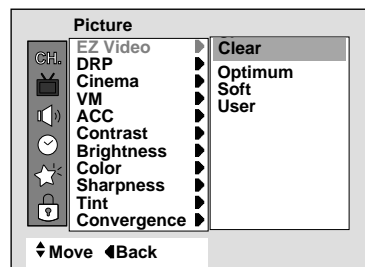

DRP (Digital Reality Picture)

This is the function to stress picture outline in showing a dark area light.

1. Press the **menu** button and then use **▲ / ▼** button to select the Picture menu.
2. Press the **▶** and then use **▲ / ▼** button to select **DRP**.
3. Press the **▶** and then use **▲ / ▼** button to select **Clear** or **Soft**.
4. Press the **exit** button to return to TV viewing.

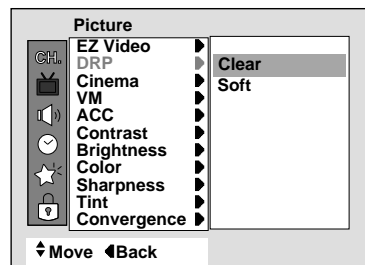

Cinema Mode Setup

Sets up the TV for the best picture appearance for viewing movies.

1. Press the **menu** button and then use **▲ / ▼** button to select the Picture menu.
2. Press the **▶** and then use **▲ / ▼** button to select **Cinema**.
3. Press the **▶** and then use **▲ / ▼** button to select **On** or **Off**.
4. Press the **exit** button to return to TV viewing.

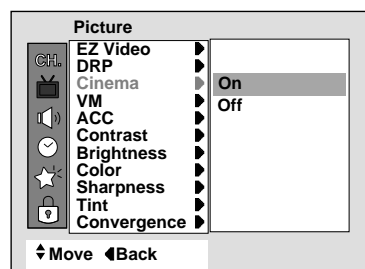

VM (Velocity Modulation) Setup

If you select **VM High**, the TV will automatically enhance the sharpness of the image's edges.

1. Press the **menu** button and then use **▲ / ▼** button to select the Picture menu.
2. Press the **▶** and then use **▲/▼** button to select **VM**.
3. Press the **▶** and then use **▲/▼** button to select **High, Medium, Low** or **Off**.
4. Press the **exit** button to return to TV viewing.

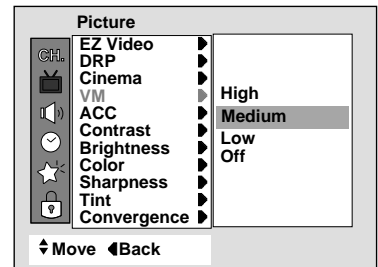

ACC (Auto Color Control) Setup

Specify the picture color appearance.

1. Press the **menu** button and then use **▲ / ▼** button to select the Picture menu.
2. Press the **▶** and then use **▲/▼** button to select **ACC**.
3. Press the **▶** and then use **▲/▼** button to select **Cool, Normal**, or **Warm**.
4. Press the **exit** button to return to TV viewing.

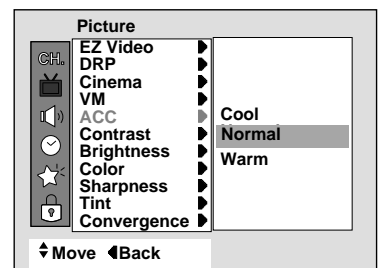

User Picture Appearance Adjustments

This is the function to manually adjust the picture levels: **Contrast, Brightness, Color, Sharpness**, and **Tint** to your preference. If the picture settings you adjust are not satisfactory, you can also select a factory preset picture setup. In the broadcasting system PAL-M/N, the picture option **Tint** is not adjustable.

1. Press the **menu** button and then use **▲ / ▼** button to select the Picture menu.
2. Press the **▶** and then use **▲/▼** button to select the desired picture option (**Contrast, Brightness, Color, Sharpness**, and **Tint**).
3. Press the **▶** and then use **◀/▶** button to adjust the level. The setting of highlighted menu option is displayed. Use the **▲/▼** button to select other options.
4. Press the **exit** button to return to TV viewing.

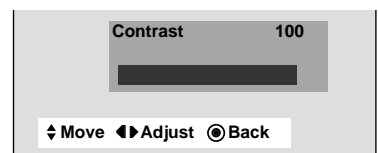
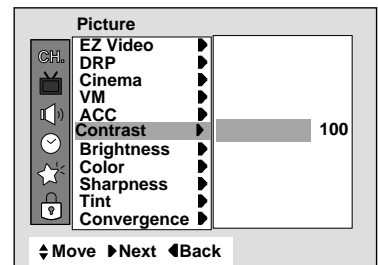

Color Convergence Adjustment (R40W46, R40W46F, R45W46, R45W46F only)

Use this function to adjust the R-G-B color convergence while a stable signal is being received. When the TV is first installed or if it is relocated, the picture may be unstable with three color ghosts (red, green, blue). This problem can be solved by adjusting the color convergence.

1. Press the **menu** button and then use **▲ / ▼** button to select the Picture menu.
2. Press the **▶** and then use **▲ / ▼** button to select **Convergence**.
3. Press the **▶** and then use **▲ / ▼** button to select **1 [+]** (all point convergence) or **9 [+]** (9 point convergence) .
If the + display is not white and shows three color ghosts, the color convergence needs to be adjusted. If the + display is white, color convergence does not need to be adjusted.
4. Press the **▶** and then press the **tv/video** button.
The display **◀▶** button is selected in red or blue.
5. **Only selecting 9 [+]** : Use the number (0-9) button to select the position your want to adjust the convergence.
6. Use the **▲ / ▼ / ◀ / ▶** button to superimpose the + display (red or blue) over the green +. It will be changed to yellow or cyan.
7. When both red and blue + display is superimposed over green, the + display changes to white.
8. Press the **exit** button to return to TV viewing.

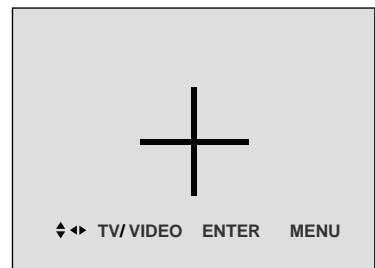
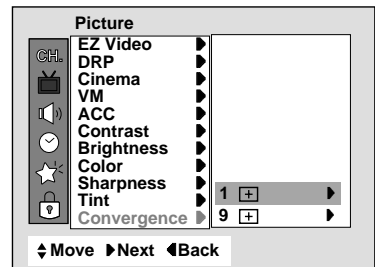

Note: If the picture needs to be adjusted more **1 [+]** (all point convergence) adjustment, you can adjust the **9 [+]** (9 point convergence) for the position you want to adjust.

Auto Convergence Adjustment (R50W46 and R57W46 only)

When the TV is first installed or relocated, the picture may be unstable and have three color ghosts (red, green, blue). This problem can be solved with Auto Convergence. This function can adjust the picture color convergence automatically if the TV is receiving a stable signal.

1. Press the **menu** button and then use **▲ / ▼** button to select the Picture menu.
2. Press the **▶** and then use **▲ / ▼** button to select **Convergence**.
3. Press the **▶** button to start auto convergence.
The color convergence order will be: blue, green, then red.
The auto convergence function takes about 60 seconds.

Notes: • Wait 20 minutes after turning on the TV before using Auto Convergence.

- Darken the room before adjusting color convergence.

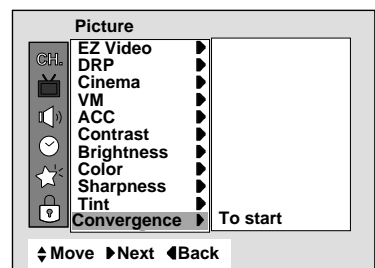

Stereo/SAP Broadcasts Setup

This TV can receive MTS stereo programs and any SAP (Second Audio Program) accompanying the stereo program. The broadcaster may transmit one additional sound signal as well as the original one. The MTS function doesn't operate in the video mode.

1. Use the **mts** button to select your desired MTS mode.
Each time you press this button, the **Mono**, **Stereo**, or **SAP** mode appear in turn.
2. Press the **enter** (⊙) button to return to TV viewing.

Notes

- Stereo or SAP can only be received if the TV station transmits those signals, even though you have selected **Stereo** or **SAP**.
- Mono sound is automatically received if the broadcast is only in Mono; even though **Stereo** or **SAP** has been selected.
- Select **Mono** if you want to listen to mono sound in remote fringe areas during a stereo/SAP broadcast.

EZ Audio Options

You can enjoy the best sound without any special adjustment because the TV automatically adjusts the sound appropriate for the program character.

EZ Audio set up using the audio button

1. Press the **audio** button repeatedly to select **Virtual**, **Flat**, **Music**, **Movie**, **Sports**, or **User**.
2. Press the **enter** (⊙) button to exit.

EZ Audio set up using the Audio menu

1. Press the **menu** button and then use ▲ / ▼ button to select the Sound menu.
2. Press the ► and then use ▲ / ▼ button to select **EZ Audio**.
3. Press the ► and then use ▲ / ▼ button to select **Virtual**, **Flat**, **Music**, **Movie**, **Sports**, or **User**.
4. Press the **exit** button to return to TV viewing.

Note: • Manufactured under license from Dolby Laboratories.
“Dolby” and the double-D symbol are trademarks of Dolby Laboratories.

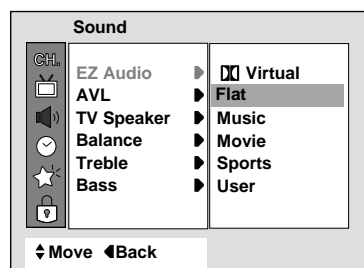

AVL (Auto Volume Leveler)

AVL automatically maintains an equal volume level even if you change channels.

1. Press the **menu** button and then use ▲ / ▼ button to select the Sound menu.
2. Press the ► and then use ▲/▼ button to select **AVL**.
3. Press the ► and then use ▲/▼ button to select **On** or **Off**.
4. Press the **exit** button to return to TV viewing.

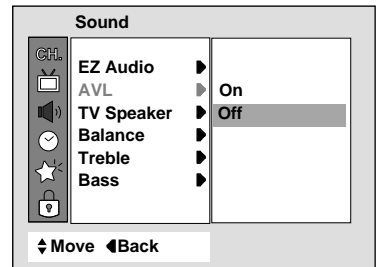

TV Speaker On/Off

If you want hear the sound on your external hi-fi stereo system, select **TV Speaker - Off** to turn the TV internal speakers off.

1. Press the **menu** button and then use ▲ / ▼ button to select the Sound menu.
2. Press the ► and then use ▲/▼ button to select **TV Speaker**.
3. Press the ► and then use ▲/▼ button to select **On** or **Off**.
4. Press the **exit** button to return to TV viewing.

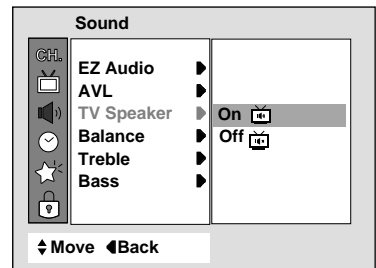

Adjusting Balance, Treble, Bass

Manually adjust the sound levels: **Balance**, **Treble**, and **Bass** to your preference.

1. Press the **menu** button and then use ▲ / ▼ button to select the Sound menu.
2. Press the ► and then use ▲/▼ button to select the desired sound option (**Balance**, **Treble**, and **Bass**).
3. Press the ► and then use ◀/▶ button to adjust the level. Use the ▲/▼ button to select other options.
4. Press the **exit** button to return to TV viewing.

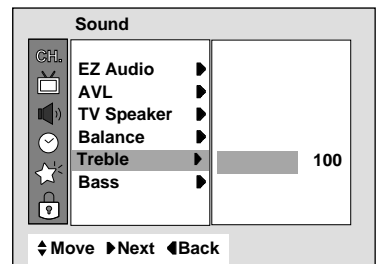

PIP (Picture-in-Picture) /Twin Picture

Notes: PIP does not work using Component 1080i mode.
PIP is not available if Parental Control (Lock) is active.

Watching PIP (Picture-in-Picture)

PIP is a smaller inset picture placed on the larger main picture screen. Using the PIP feature enables you to view two different programs on the TV screen at the same time.

1. Use the **pip** button to select either the PIP mode, twin picture mode or POP (Picture-Out-Picture) mode. Press the **pip** button repeatedly to select the desired sub picture size. The sub picture appears as indicated below.

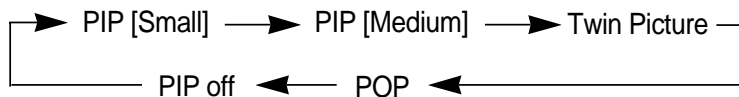

2. Use the **pipch+** or **pipch-** button to select the desired channel for the sub picture.

Note

- Use the **ch ▲/ch▼** button to select the next higher/lower channel for the main picture and use the **pipch+/pipch-** button to select the next higher/lower channel for the sub picture.

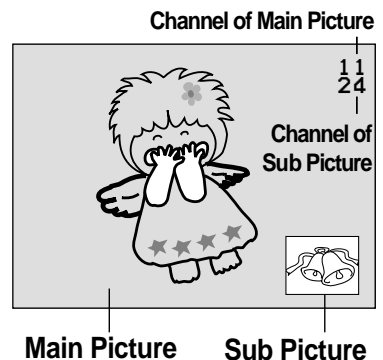

Selecting PIP and Twin picture viewing sources (In PIP and Twin picture modes)

1. Press the **menu** button and then use **▲ / ▼** button to select the Special menu.
2. Press the **▶** and then use **▲/▼** button to select the **PIP Input**.
3. Press the **▶** and then use **▲ / ▼** button to select the **TV, Video 1, Video 2, Video 3, Video 4**.
4. Press the **exit** button to return to TV viewing.

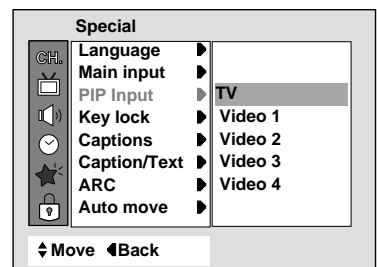

Moving the Sub Picture (in PIP mode)

Press the **position** button to change the sub picture position. Each press of **position** moves the sub picture in a clockwise direction.

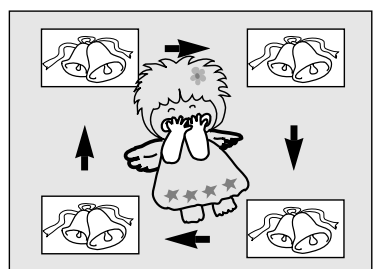

POP (Picture-Out-Picture: Channel Search and Display)

Use this Channel Search to view the current programs on all the memorized channels one-by-one on the 12 POP screen display, while the main screen displays the current channel.

Press the **pip** button in twin picture mode. The pictures of all the memorized channels are shown on the 12 PIP screen, as shown to the right.

To exit channel search, press the **pip** button.

Notes

- By pressing the **swap** button, you can view the channel being scanned on the PIP screen enlarged on the main screen.
- Run Auto program before using POP mode.

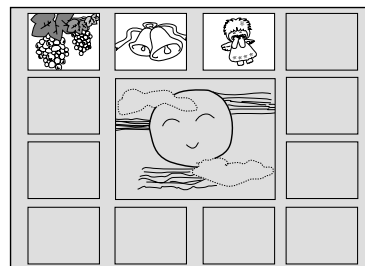

Still Picture (Freeze)

Press the **still** button. In PIP and twin picture mode, the sub picture's image is frozen.

To cancel the still picture, press the **still** button again.

Notes

- If PIP mode is not active, the currently-viewed picture's image is frozen when the **still** button is pressed.
- This function doesn't work in Component 1080i mode.

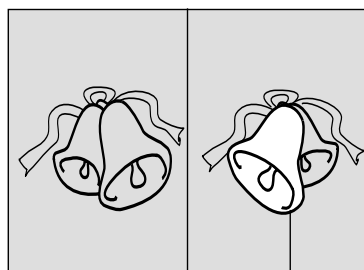

Still picture
Twin Picture Mode

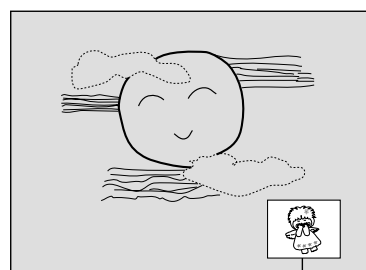

Still picture
PIP Mode

Swapping Main/Sub Pictures

Press the **swap** button. Each time you press **swap**, the main and sub pictures images are switched.

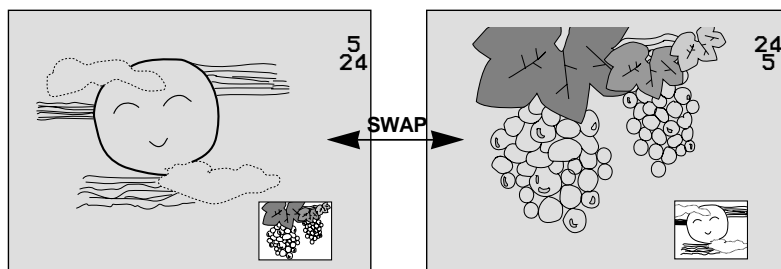

Closed Captions

Closed captioning is a process which converts the audio portion of a television program into written words, which then appear on the television screen in a form similar to subtitles. Closed captions allow viewers to read the dialogue and narration of television programs.

Using Closed Captions

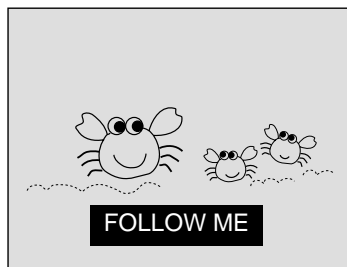

Captions are the subtitles for the dialogue and narration of television programs. For prerecorded programs, program dialogue can be arranged into captions in advance. It is possible to caption a live program by using a process called “real-time captioning”, which creates captions instantly. Real-time captioning is normally done by professional reporters using a machine shorthand system with computer for translation into English.

Captioning is an effective system for the hearing-impaired, and it can also be used as an aid in teaching language skills.

- The picture at left shows a typical caption.

Caption Tips

- Not all TV broadcasts include closed caption signals.
- Sometimes TV stations broadcast two different caption signals on the same channel. By selecting CC 1 or CC2, you can choose which signal you view. CC 1 is usually the signal with the captions, while CC 2 might show demonstration or programming information.
- Your TV might not display caption signals correctly under the following circumstances.

1. Poor reception conditions are encountered:



- **IGNITION:**

Picture may flutter, drift, display black spots or horizontal streaking, which are usually caused by interference from automobile ignition systems, neon lamps, electrical drills or other electrical appliances.



- **GHOSTS:**

Ghosts are caused when the TV signal splits and follows two paths. One is the direct path and the other is reflected off tall buildings, hills or other objects. Changing the direction or position of the antenna may improve reception.



- **SNOW:**

If your TV is located at the weak, fringe area of a TV signal, your picture may be marred by small dots. It may be necessary to install a special antenna to improve the picture.

2. An old, bad or illegally recorded being played.
3. Strong, random signals from a car or airplane interfere with the TV signal.
4. The signal from the antenna is weak.
5. The program wasn't captioned when it was produced, transmitted or taped.

Displaying Text

Text services offer a wide variety of information on all kinds of subjects (ex. captioned program lists, weather forecasts, stock exchange topics, news for hearing-impaired---) filling the TV screen.

However, even though the program does offer captioning, text services may not be available.

Note

- In the event you are receiving a poor signal, an empty black box may appear and disappear, when text mode is turned on. This commonly happens under poor signal conditions.

Captions On, Off, EZ mute Setup

Captions set up using the cc button

1. Use the **cc** button to select **On**, **EZ Mute** or **Off**.
2. Press the **enter** (Ⓞ) button to remove menu.



Captions set up using the Captions Menu

1. Press the **menu** button and then use **▲ / ▼** button to select the Special menu.
2. Press the **▶** and then use **▲ / ▼** button to select **Captions**.
3. Press the **▶** and then use **▲ / ▼** button to select **On**, **EZ Mute** or **Off**.
4. Press the **exit** button to return to TV viewing.

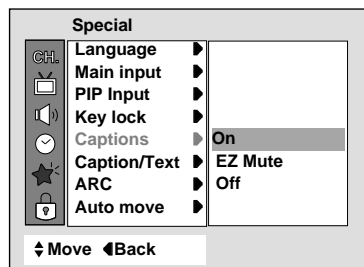

Note

- EZ mute shows the selected captions option (if available on program) when the TV sound is muted.

Selecting Caption/Text Mode

1. Press the **menu** button and then use **▲ / ▼** button to select the Special menu.
2. Press the **▶** and then use **▲ / ▼** button to select **Caption/Text**.
3. Press the **▶** and then use **▲ / ▼** button to select **CC1**, **CC2**, **CC3**, **CC4**, **Text 1**, **Text 2**, **Text 3**, or **Text 4**.
4. Press the **exit** button to return to TV viewing.

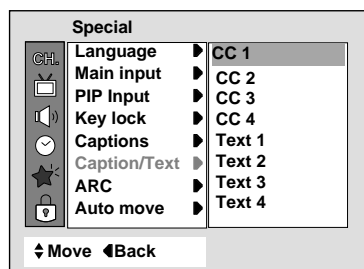

Note

- This TV is programmed to retain the caption mode setting, when you turn the TV off.

Parental Control Overview

Parental Control (V-Chip) can be set up to block program viewing based on the restriction settings. The default setting is to allow all programs to be viewed. Viewing can be blocked by the type of program and by the categories chosen to be blocked. It is also possible to block all program viewing for a time period. To use Parental Control, Function, the following must be set.

1. Ratings and categories to be blocked.
2. A password.
3. Enabling the lock.

V-Chip Rating and Categories

Rating guidelines are provided by broadcast stations. Most television programs and television movies can be blocked by TV Rating and/or Individual Categories. Movies that have been shown at the theaters or direct-to-video movies use the Movie Rating System (MPAA) only.

For Movies Previously Shown in Theaters

Movie Ratings:

- Unblocked
- G and Above (general audience)
- PG and Above (parental guidance suggested)
- PG-13 and Above (13 years and up)
- R and Above (restricted)
- NC-17 and Above (18 years and up)
- X (adult)

If you set PG-13 and Above, G and PG movies will be available; PG-13, R, NC-17, and X will be blocked.

For Television programs including made-for-TV movies:

General TV Ratings:

- Unblocked
- TV-G and Above (general audience) (individual categories do not apply)
- TV-PG and Above (parental guidance suggested)
- TV-14 and Above (14 years and up)
- TV-MA (mature audience)

Children TV Ratings:

- Unblocked
- TV-Y and Above (youth) (individual content categories do not apply)
- TV-Y7 (youth, 7 years and up)

Content Categories:

- Dialogue - sexual dialogue (applies to TV-PG and Above, TV-14)
- Language - adult language (applies to TV-PG and Above, TV-14 and Above, TV-MA)
- Sex - sexual situations (applies to TV-PG and Above, TV-14 and Above, TV-MA)
- Violence (applies to TV-PG and Above, TV-14 and Above, TV-MA)
- F Violence - fantasy violence (applies only to TV-Y7)

Canadian English language rating system:

- Unblocked
- C and above (Children)
- C8 and above (8 years and up)
- G and above (General audience)
- PG and above (Parental guidance suggested)
- 14+ and above (Viewers 14 years and up)
- 18+ and above (Adult)

Canadian French language rating system:

- Unblocked
- G (General audience)
- 8 ans+ and above (8 years and up)
- 13 ans+ and above (13 years and up)
- 16 ans+ and above (16 years and up)
- 18 ans+ (Adult)

Blocking Scheme Setup

1. Press the **menu** button and then use ▲ / ▼ button to select the Lock menu.
2. Press the ► and then set the initial 4-digit password "0-0-0-0" with the number keypad. If Parental is already set, enter the password when requested.
3. Press the ▲/▼ button to select the **Lock on/off** option.
4. Press the ► and then use the ▲/▼ button to select the **on** or **off**.
5. Press the ◀ and then use the ▲ / ▼ button to select the **Set password**.
6. Press the ► button. Enter a four number password. Enter it again when requested.
7. Use the ▲/▼ button to select the types of blocking to be set.
8. Press the ► and then use the ▲ / ▼ button to select the types of ratings to block.
Age block, Content block, and Canadian options, also have sub menus; repeat steps 7 to 8 in sub menu, to set type of blocking and rating.
9. Press the **exit** button to return to TV viewing.

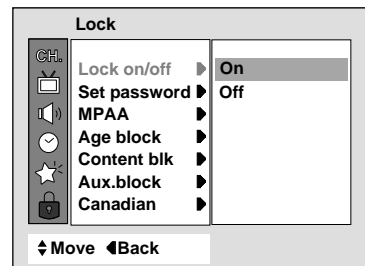

Antenna Connections

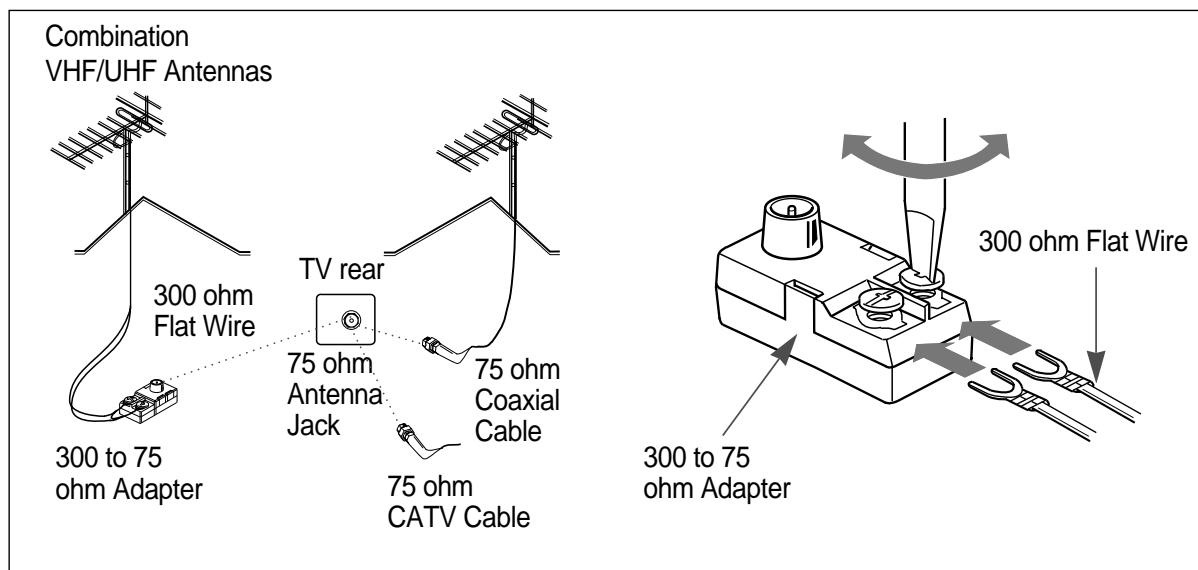

Connecting an Outdoor Antenna

For the best signal reception, we recommend you use an outdoor antenna.

Severely weathered antennas and antenna cables can reduce the signal quality. Before connecting an outdoor antenna, inspect it yourself or have a TV technician inspect it. Any service center can explain the various outdoor antenna options available to you.

300 Ohm Flat Wire

1. Connect the 300 ohm flat wire to screws on the 300 ohm to 75 ohm adapter.
2. Push the end of 300 ohm to 75 ohm adapter onto 75 ohm antenna jack.

75 Ohm Coaxial Cable

1. Connect the 75 ohm coaxial cable directly to the 75 ohm antenna jack.

Connecting a CATV Cable

If you subscribe to a CATV system, use the antenna connection described below.

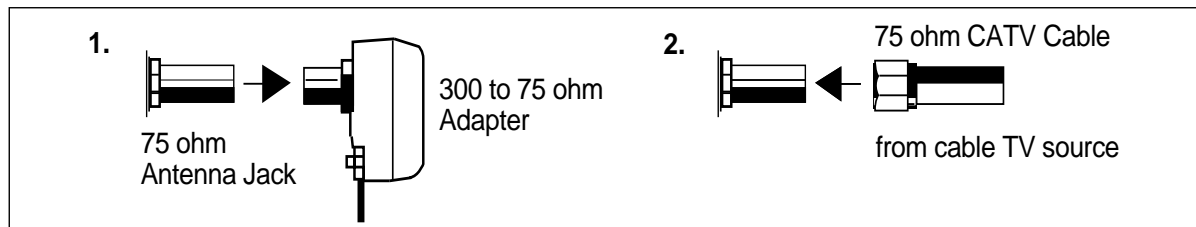

1. Remove the 300 to 75 ohm adapter or the cable from the set if attached.
2. Connect the CATV cable (75 ohm coaxial cable) to the 75 ohm antenna jack.

External Equipment Connection and Viewing Setup

You can connect additional equipment, such as VCRs, camcorders etc. to your TV. Connection panels shown here may be somewhat different from your TV. Here is an example drawing of a typical jackpack layout.

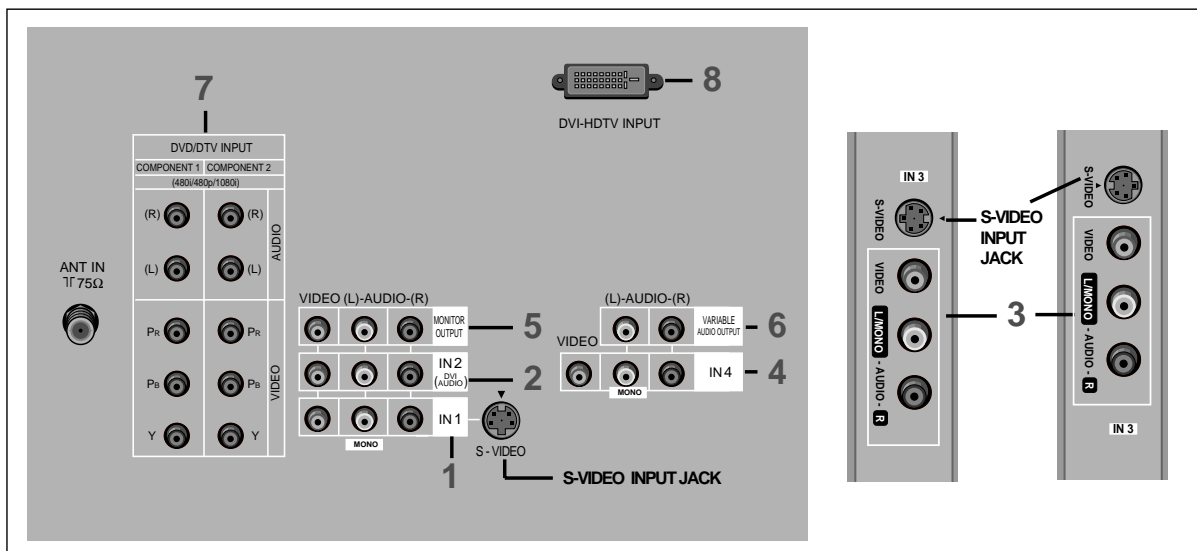

1. **IN 1 JACKS** : Connect external equipment outputs (VCR, DVD, CAMCORDER) to these inputs. Press the **tv/video** button repeatedly to select **Video 1**.
2. **IN 2 JACKS** : Connect external equipment outputs (VCR, DVD, CAMCORDER) to these inputs. Press the **tv/video** button repeatedly to select **Video 2**.
3. **IN 3 JACKS** : Connect external equipment outputs (VCR, DVD, CAMCORDER) to these inputs. Press the **tv/video** button repeatedly to select **Video 3**.
4. **IN 4 JACKS** : Connect external equipment outputs (VCR, DVD, CAMCORDER) to these inputs. Press the **tv/video** button repeatedly to select **Video 4**.
5. **MONITOR OUTPUT JACKS** : Connect a second TV or a monitor to these outputs to observe the selected program.
6. **VARIABLE AUDIO OUT JACKS**: Connect external analog stereo amplifier and use external front speakers.
7. **DVD/DTV INPUT JACKS** : Connect component output jacks to these inputs. Use the **tv/video** or **comp/dvi** button to select **Component 1**, **Component 2** sources. Your set-top devices may be used if they have a DVI-HDTV output connector that supports the proper version of DVI and HDCP.
8. **DVI-HDTV INPUT JACK**: Connect a set-top box to this input. Use the **tv/video** or **comp/dvi** button to select **DVI**.

Note : Avoid having a stationary fixed image remain on the screen for a long period of time. Typically a frozen still picture from a VCR. If allowed to remain on the screen ; a fixed image may remain visible on the screen.

EZ Notice: Make A/V Connection

You can only select connected input sources with the **tv/video** or **comp/dvi** button on the remote control. (It's not available in DVI input source.)

VCR Connections

1. Connect the audio/video output jacks from the VCR to **IN 1 (A/V)** jacks on the TV.
2. Use the **tv/video** button to select **Video 1**.
 - If you connect the audio/video output jacks from the VCR to the **IN2, IN3** or **IN4** jacks on the TV, select **Video 2, Video3,** or **Video 4**.
3. Press the **PLAY** button on the VCR.
The video playback appears on the TV screen.

Notes

- If using a monaural VCR, connect the output jack from VCR to the **AUDIO L/MONO IN** jack on TV so that the sound can be heard from both speakers. If you connect the output jack to the **AUDIO R IN** jack on the TV, the sound is only heard from right speaker.
- When the input jacks on the front panel and back panel are connected to external equipment at the same time, the input jacks on the front panel have priority over the input jacks on the back panel of the TV.

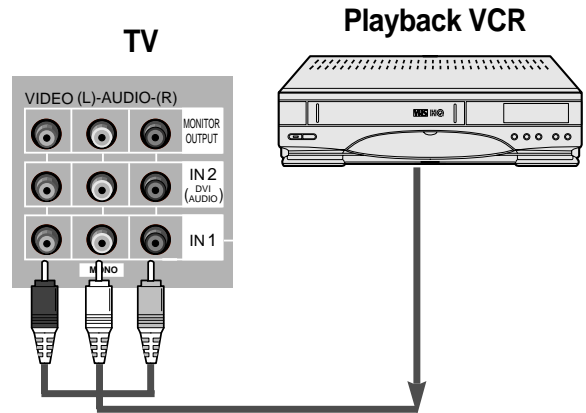

S-VHS VCR Connections

1. Connect the S-VHS output jack from the VCR to one of the available **S-VIDEO** jacks on the TV.
2. Connect the audio/video output jacks from the VCR to the **IN 1** or **IN 3** jacks on the TV.
3. Use the **tv/video** button to select **Video 1** or **Video 3**.
4. Press the **PLAY** button on the VCR.
The video playback is visible on the TV screen.

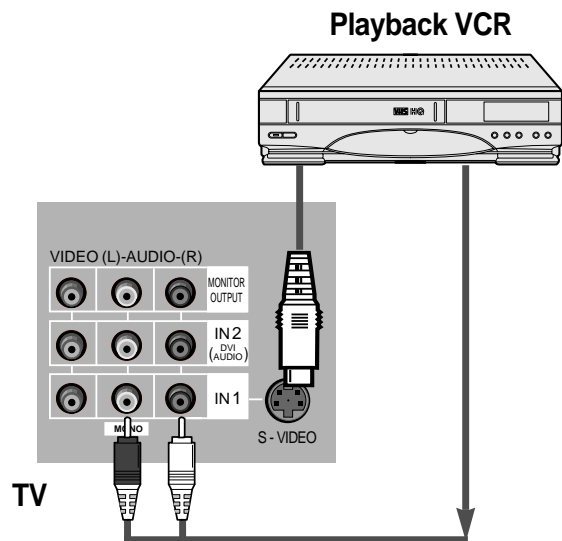

Monitor Out Setup

1. Connect the audio/video input jacks from Second TV/Monitor to the **MONITOR OUTPUT (A/V)** jacks on the TV.
2. See the operating manual of the second TV or monitor for further details regarding that device's input source selection.

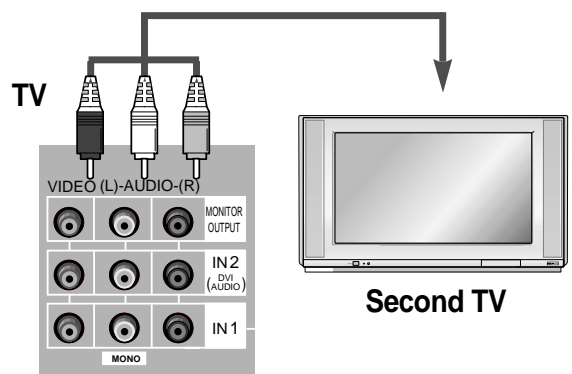

External Stereo Amplifier/Speakers

1. Connect analog/stereo amplifier input jacks to variable audio out of the TV.
2. Set up your speakers through your analog/stereo amplifier, according to the instructions provided with the amplifier.

Note

- If you want to hear the sound through your amplifier's speakers, set the **TV Speaker** option to **Off** (Refer to p.17).

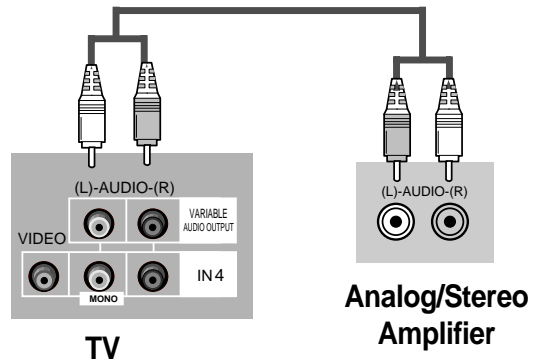

DVD Player Connection

1. Connect the DVD component video outputs to Y, P_B, P_R (480i/480p/1080i) on the TV and DVD audio outputs to right and left audio jack (L/R) inputs on the TV.
2. Turn on the DVD player and insert a DVD.
3. Use the **tv/video** or **comp/dvi** button to select **Component 1** or **Component 2**.

Note

- This TV is programmed to remember which mode it was last set to, even if you turn the TV off.

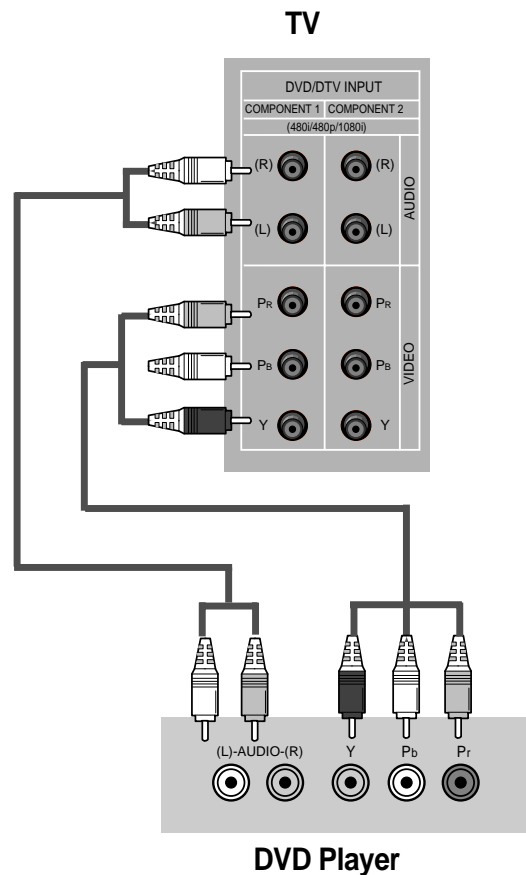
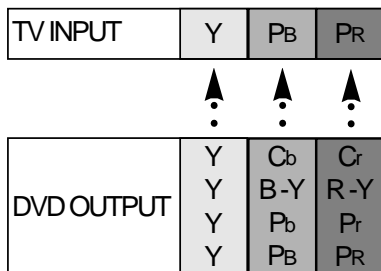

External Equipment Connection and Viewing Setup

DTV (Set-top Box) Connection

1. Connect DTV component video outputs to Y, P_B, P_R on the TV and audio outputs to audio (L/R) left/right input jacks.
2. Turn on the digital set-top box.
Use the **tv/video** or **comp/dvi** button to select **Component 1** or **Component 2**.
 - If you connected the DVI output jack from the DTV to the DVI input jack on the TV, select **DVI**.

Note

- For the best access to high-definition programming at the highest available resolution broadcast, connect the DVI-HDTV output to the corresponding DVI-HDTV input that supports High-band-width Digital Content Protection (HDCP) technology on your High-Definition monitor. Please check your HDTV set-top box or HDTV receiver user's manual or contact the manufacturer to find out if your HDTV receiver provides HDCP output.

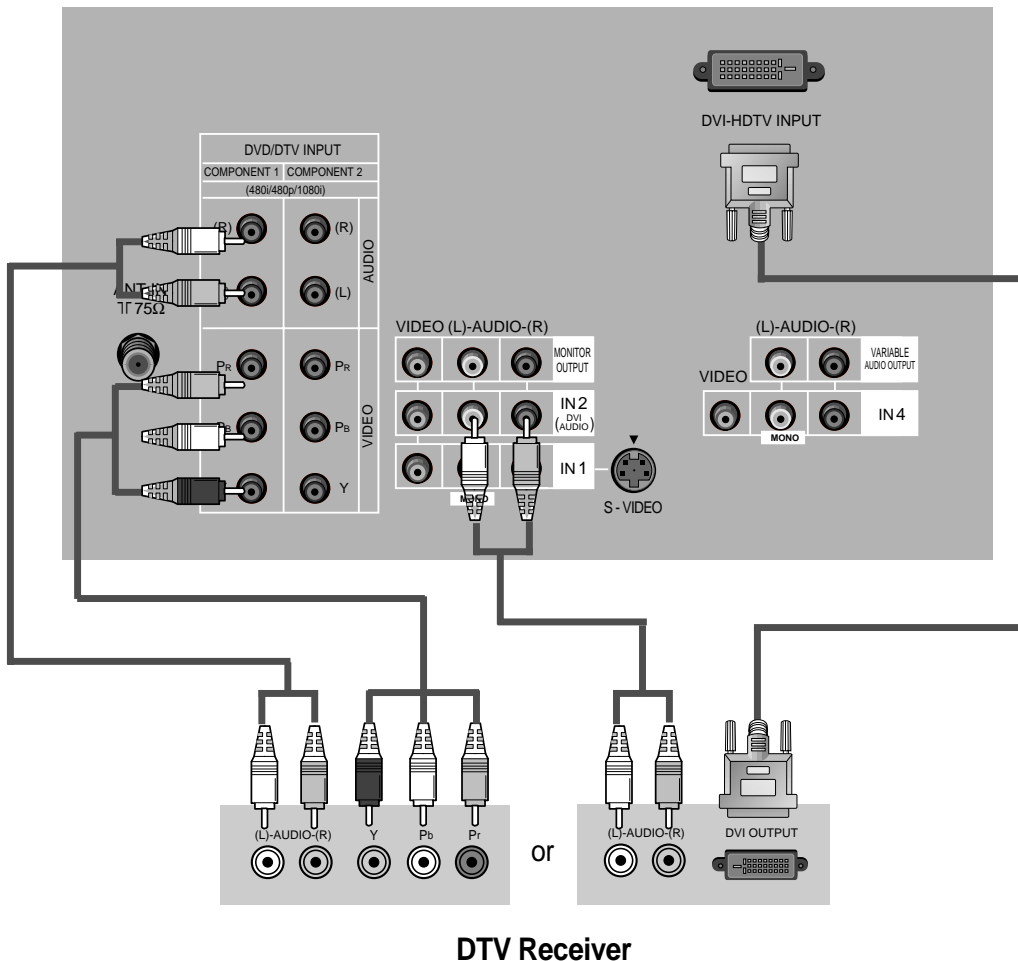

Programming the Remote to operate other devices

The remote control for your projection TV is a multi-brand or universal remote control. It can be programmed to operate most remote-controllable devices of other manufacturers.

Note that the remote control may not control all models of other brands.

1. Test your remote control.

To find out whether your remote control can operate the IR device without programming, turn on the IR device such as a VCR and press the corresponding mode button (VCR) on the remote control, while pointing at the IR device. Test the POWER and CH +/- buttons to see if IR device responds properly. If not, the remote requires programming to operate the device.

2. Turn on the IR device to be programmed, then press the corresponding mode button on the remote control.

3. Press the POWER and MUTE buttons simultaneously, the remote control is ready to be programmed for the code.

4. There are two ways to find the right code for the IR device.

A. If you press the CH +/- buttons repeatedly, the codes will change one at-a-time. Press the POWER button after each code change. If the right code is found, the device will turn off.

B. Enter a code number using the number buttons on the remote. Programming code numbers for the corresponding component can be found on the following pages. Again, if the code is correct, the device will turn off.

5. Press the EXIT button to store the code.

6. Test the remote control functions to see if the IR device responds properly. If not, repeat from step 2.

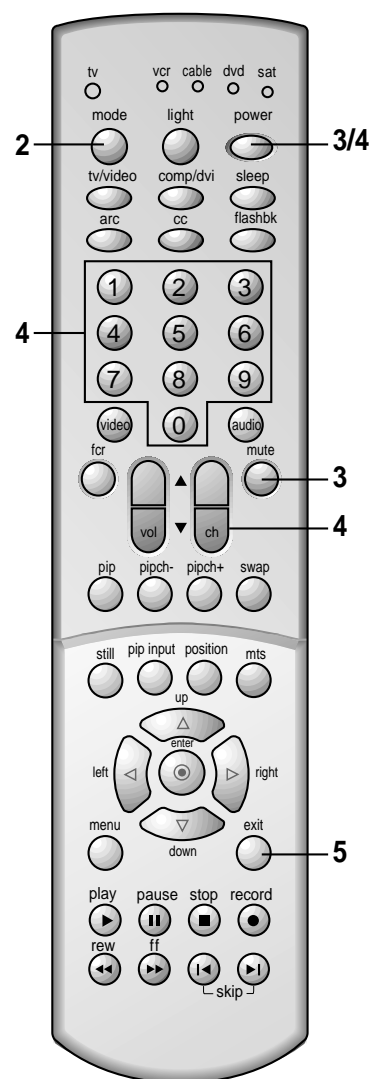

Programming Codes

VCRs

Brand	Codes	Brand	Codes	Brand	Codes
AIWA	034	LXI	003 009 013	SAMSUNG	032 040 102
AKAI	016 043 046		014 017 034		104 105 107
	124 125 146		101 106		109 112 113
AMPRO	072	MAGIN	040		115 120 122
ANAM	031 033 103	MAGNAVOX	031 033 034	SANSUI	022 043 048
AUDIO DYNAMICS	012 023 039		041 067 068		135
	043	MARANTZ	012 031 033	SANYO	003 007 010
BROKSONIC	035 037 129		067 069		014 102 134
CANON	028 031 033	MARTA	101	SCOTT	017 037 112
CAPEHART	108	MATSUI	027 030		129 131
CRAIG	003 040 135	MEI	031 033	SEARS	003 008 009
CURTIS MATHES	031 033 041	MEMOREX	003 010 014		010 013 014
DAEWOO	005 007 010		031 033 034		017 020 031
	064 065 108		053 072 101		042 073 081
	110 111 112		102 134 139		101
	116 117 119	MGA	045 046 059	SHARP	031 054 149
DAYTRON	108	MINOLTA	013 020	SHINTOM	024
DBX	012 023 039	MITSUBISHI	013 020 045	SONY	003 009 031
	043		046 049 051		052 056 057
DYNATECH	034 053		059 061 151		058 076 077
ELECTROHOME	059	MTC	034 040		078 149
EMERSON	006 017 025	MULTITECH	024 034	SOUNDESIGN	034
	027 029 031	NEC	012 023 039	STS	013
	034 035 036		043 048	SYLVANIA	031 033 034
	037 046 101	NORDMENDE	043		059 067
	129 131 138	OPTONICA	053 054	SYMPHONIC	034
	153	PANASONIC	066 070 074	TANDY	010 034
FISHER	003 008 009		083 133 140	TATUNG	039 043
	010		145	TEAC	034 039 043
FUNAI	034	PENTAX	013 020 031	TECHNICS	031 033 070
GE	031 033 063		033 063	TEKNIKA	019 031 033
	072 107 109	PHILCO	031 034 067		034 101
	144 147	PHILIPS	031 033 034	THOMAS	034
GO VIDEO	132 136		054 067 071	TMK	006
GOLDSTAR	012 013 020		101	TOSHIBA	008 013 042
	101 106 114	PILOT	101		047 059 082
	123	PIONEER	013 021 048		112 131
HARMAN KARDON	012 045	PORTLAND	108	TOTEVISION	040 101
HITACHI	004 018 026	PULSAR	072	UNITECH	040
	034 043 063	QUARTZ	011 014	VECTOR RESEARCH	012
	137 150	QUASAR	033 066 075	VICTOR	048
INSTANTREPLAY	031 033		145	VIDEO CONCEPTS	012 034 046
JCL	031 033	RCA	013 020 033	VIDEOSONIC	040
JCPENNY	012 013 015		034 040 041	WARDS	003 013 017
	033 040 066		062 063 107		024 031 033
	101		109 140 144		034 040 053
JENSEN	043		145 147		054 131
JVC	012 031 033	REALISTIC	003 008 010	YAMAHA	012 034 039
	043 048 050		014 031 033		043
	055 060 130		034 040 053	ZENITH	001 034 048
	150 152		054 101		056 058 072
KENWOOD	014 034 039	RICO	058		080 101
	043 047 048	RUNCO	148		
LG	255	SALORA	014		
LLOYD	034				

SAT

Brand	Codes	Brand	Codes	Brand	Codes
ALPHASTAR DSR	123	HITACHI	139 140	REALISTIC	043 074
AMPLICA	050	HOUSTON TRACKER	033 037 039	SAMSUNG	123
BIRDVIEW	051 126 129		051 057 104	SATELLITE SERVICE CO	028 035 047
BSR	053	HUGHES	068		057 085
CAPETRONICS	053	HYTEK	053	SCIENTIFIC ATLANTA	032 138
CHANNEL MASTER	013 014 015	JANIEL	060 147	SONY	103
	018 036 055	JERROLD	061	STARCAST	041
CHAPARRAL	008 009 012	KATHREIN	108	SUPER GUIDE	020 124 125
	077	LEGEND	057	TEECOM	023 026 075
CITOH	054	LG	255		087 088 090
CURTIS MATHES	050 145	LUTRON	132		107 130 137
DRAKE	005 006 007	LUXOR	062 144	TOSHIBA	002 127
	010 011 052	MACOM	010 059 063	UNIDEN	016 025 042
	112 116 141		064 065		043 044 045
DX ANTENNA	024 046 056	MEMOREX	057		048 049 078
	076	NEXTWAVE	028 124 125		079 080 086
ECHOSTAR	038 040 057	NORSAT	069 070		101 135 136
	058 093 094	PACE SKY SATELLITE	143	VIEWSTAR	115
	095 096 097	PANASONIC	060 142	WINEGARD	128 146
	098 099 100	PANSAT	121	ZENITH	001 081 082
	122	PERSONAL CABLE	117		083 084 091
ELECTRO HOME	089	PHILIPS	071		120
EUROPLUS	114	PICO	105		
FUJITSU	017 021 022	PRESIDENT	019 102		
	027 133 134	PRIMESTAR	030 110 111		
GENERAL INSTRUMENT	003 004 016	PROSAT	072		
	029 031 059	RCA	066 106		
	101				

DVD

Brand	Codes	Brand	Codes	Brand	Codes
APEX DIGITAL	022	MARANTZ	024	PROCEED	021
DENON	020 014	MITSUBISHI	002	PROSCAN	005 006
GE	005 006	NAD	023	RCA	005 006
GOLDSTAR	010 016 025	ONKYO	008 017	SAMSUNG	011 015
HARMAN KARDON	027	PANASONIC	003 009	SONY	007
JVC	012	PHILIPS	013	THOMPSON	005 006
LG	001 010 016	PIONEER	004 026	TOSHIBA	019 008
	025			YAMAHA	009 018
MAGNAVOX	013			ZENITH	010 016 025

Programming Codes

CATV

Brand	Codes	Brand	Codes	Brand	Codes
ABC	003 004 039 042 046 052 053	LG	255	SAMSUNG	030 068
ANTRONIK	014	M-NET	037	SCIENTIFIC ATLANTA	003 011 041
ARCHER	005 007 014 024	MACOM	033		042 043 045
CABLE STAR	026	MAGNAVOX	010 012 064 079	SHERITECH	022
CENTURION	092	MEMOREX	001	SIGNAL	030
CENTURY	007	MOVIE TIME	028 032	SIGNATURE	052
CITIZEN	007	NSC	015 028 038 071 073	SL MARX	030
COLOUR VOICE	065 090	OAK	016 031 037 053	SPRUCER	047 078
COMBANO	080 081	PANASONIC	044 047	STARCOM	002 004 008
COMTRONICS	019 030	PARAGON	001		009
DIAMOND	023	PHILIPS	006 012 013 020 065 085	STARGATE	008 030
EAGLE	020 030 040		090	SYLVANIA	067
EASTERN	057 062 066		090	TADIRAN	030
ELECTRICORD	032	PIONEER	034 051 052 063 076	TANDY	017
GE	072		063 076	TEXSCAN	029 067
GEMINI	008 022 025 054	POST NEWS WEEK	016	TOCOM	039 040 056
GI	052 074	PRUCER	059	TOSHIBA	001
GOLDEN CHANNEL	030	PTS	011 048 071 072 073 074	UNIKA	007 014 024
HAMLIN	049 050 055	PULSAR	001	UNITED CABLE	004 053
HITACHI	052 055	RCA	047	UNIVERSAL	007 014 024 026 027
HOSPITALITY	070 077	REGAL	049 050		032 035
JERROLD	002 003 004 008 009 010 052 069 074	REGENCY	057	VIEWSTAR	012 015 018 086 087 088
		REMBRANT	025		089
		RK	091	ZENITH	001 060 093

Early malfunctions can be prevented. Careful and regular cleaning can help extend the amount of time you will have your new projection TV. Be sure to turn the power off and pull out the power plug from the wall power outlet before you begin any cleaning.

Screen Cleaning

1. Here's a great way to keep the dust off your screen for a while. Wet a soft cloth in a mixture of lukewarm water and a little fabric softener or dish washing detergent. Wring the cloth until it's almost dry, and then use it to wipe the screen.
2. Make sure the excess water is off the screen, and then let it air-dry before you turn on your TV.

Cabinet Cleaning

1. Use a soft cloth with a mild soap solution to wipe the cabinet.
2. Rinse the cloth and wipe the cabinet again.
3. Let the cabinet air-dry before turning the TV on.

Extended Absence



If you expect to leave your TV dormant for a long time (such as a vacation), unplug the power cord to protect against possible damage from lightning or power surges. If you use an off-air antenna, you may also want to disconnect it from the back of your TV before leaving.

Product Specifications

Model	R40W46, R40W46F, R45W46, R45W46F, R50W46, R57W46
Power requirements	AC 120V
Television system	NTSC
Television channels	VHF : 2 ~ 13, UHF : 14 ~ 69 Cable : 01 ~ 125
Power consumption	See the back of the TV
External antenna impedance	75 Ω
Audio output	15W + 15W
External Equipment Input/output jacks and ports	Video input jacks (4 sets) S-video input jacks (2) Component input jacks (2 sets) DVI-HDTV input port (1) Variable audio output jacks (1 set) Monitor output jack (1)

Troubleshooting Checklist

SYMPTOMS

No power

No picture or sound

Poor picture but good sound

Poor reception

Lines in picture

Ghosts (multiple images)

Remote control does not work.

Cannot tune desired channel.

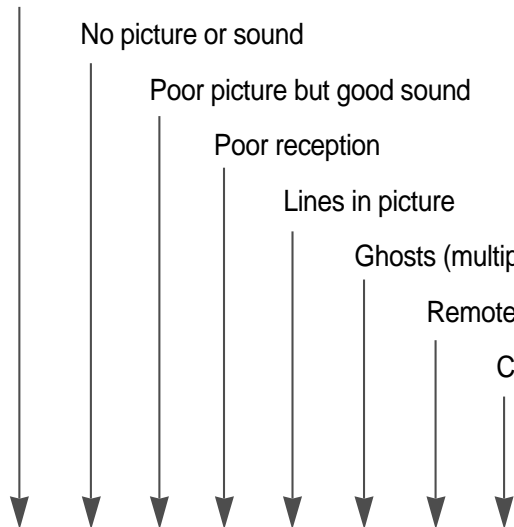
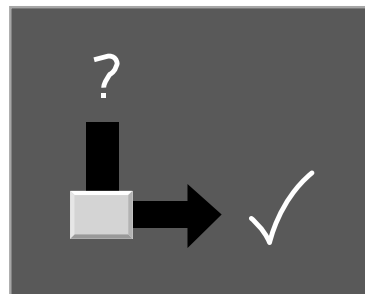

CHECK THESE THINGS

- Is power cord plugged in?
- Is television turned on?
- Check batteries in remote control.
- Try another channel (station trouble).
- Check antenna connections.
- Check for local interference.
- Adjust the antenna.
- Adjust the picture settings.
- Reprogram channels with EZ Scan.

ZENITH ELECTRONICS CORPORATION

Projection TV Limited Warranty - USA



Zenith will repair or replace your product, at Zenith's option, if it proves to be defective in material or workmanship under normal use, during the warranty period ("Warranty Period") listed below, effective from the date ("Date of Purchase") of original consumer purchase of the product. This warranty is good only to the original purchaser of the product and effective only when used in the United States, excluding U.S. Territories.

WARRANTY PERIOD:

LABOR: One Year from the Date of Purchase.

Parts: One Year from the Date of Purchase.

CRT Picture Tubes: 2 Years from the Date of Purchase.

* Parts replaced are warranted for the remaining portion of the original warranty period.

HOW SERVICE IS HANDLED

In-Home Service: Please retain dealer's dated bill of sale or delivery ticket as evidence of the Date of Purchase for proof of warranty, and submit a copy of the bill of sale to the service person at the time warranty service is provided.

Please call 1-877-9Zenith (1-877-993-6484) to locate your nearest Zenith Authorized Service Center.

Replacement parts may be new or factory remanufactured.

THIS WARRANTY IS IN LIEU OF ANY OTHER WARRANTIES, EXPRESS OR IMPLIED, INCLUDING WITHOUT LIMITATION, ANY WARRANTY OF MERCHANTABILITY OR FITNESS FOR A PARTICULAR PURPOSE. TO THE EXTENT ANY IMPLIED WARRANTY IS REQUIRED BY LAW, IT IS LIMITED IN DURATION TO THE EXPRESS WARRANTY PERIOD ABOVE. ZENITH WILL NOT BE LIABLE FOR ANY INCIDENTAL, CONSEQUENTIAL, INDIRECT, SPECIAL OR PUNITIVE DAMAGES OF ANY NATURE, EVEN IF ADVISED OF THE POSSIBILITY OF SUCH DAMAGES, INCLUDING WITHOUT LIMITATION, LOST REVENUES OR PROFITS, LOST OR CORRUPTED PROGRAMMING OR DATA, OR ANY OTHER DAMAGE WHETHER BASED IN CONTRACT, TORT, OR OTHERWISE. Some states do not allow the exclusion or limitation of incidental or consequential damages or limitation on how long an implied warranty lasts, so the above exclusion or limitation may not apply to you. This warranty gives you specific legal rights and you may also have other rights that may vary from state to state.

THIS LIMITED WARRANTY DOES NOT APPLY TO:

1. Damages or operating problems that result from shipping, installation, adjustment of user controls, calibration, maintenance or failure to maintain, or separate system components; and
2. Damages or operating problems that result from normal wear and tear, misuse, abuse, operation outside environmental specifications or contrary to the requirements or precautions in the Operating Guide, accident, lightning strikes or other natural causes, unauthorized modification or alteration, incorrect electrical current or voltage, reception problem caused by inadequate home antenna or faulty antenna connections, computer software, institutional or commercial use, or other causes not arising out of defect in material or workmanship.
3. Therefore, the cost of repair or replacement of such a defective product shall be borne by the consumer.

CUSTOMER INTER-ACTIVE CENTER NUMBERS:

For nearest Authorized Service Center, Where to buy, Product Assistance, or Customer Assistance

Call 1-877-9Zenith (1-877-993-6484) (24 hours a day, 365 days per year) and select an appropriate option from the menu.

Or visit our website at <http://www.zenithservice.com>

ZENITH ELECTRONICS CORPORATION
2000 MILLBROOK DRIVE
LINCOLNSHIRE, IL 60069

Zenith Part No. 206-03940

P/N : 3828VA0432E (d)(MP03AA)

Free Manuals Download Website

<http://myh66.com>

<http://usermanuals.us>

<http://www.somanuals.com>

<http://www.4manuals.cc>

<http://www.manual-lib.com>

<http://www.404manual.com>

<http://www.luxmanual.com>

<http://aubethermostatmanual.com>

Golf course search by state

<http://golfingnear.com>

Email search by domain

<http://emailbydomain.com>

Auto manuals search

<http://auto.somanuals.com>

TV manuals search

<http://tv.somanuals.com>