

Installation and Operating Guide | Warranty

Model Numbers | R49W36, R56W36 | Projection TVs



© Copyright 2003, Zenith Electronics Corporation.





WARNING
RISK OF ELECTRIC SHOCK
DO NOT OPEN



WARNING:

TO REDUCE THE RISK OF ELECTRIC SHOCK DO NOT REMOVE COVER (OR BACK). NO USER SERVICEABLE PARTS INSIDE. REFER TO QUALIFIED SERVICE PERSONNEL.



The lightning flash with arrowhead symbol, within an equilateral triangle, is intended to alert the user to the presence of uninsulated "dangerous voltage" within the product's enclosure that may be of sufficient magnitude to constitute a risk of electric shock to persons.



The exclamation point within an equilateral triangle is intended to alert the user to the presence of important operating and maintenance (servicing) instructions in the literature accompanying the appliance.

WARNING:

TO PREVENT FIRE OR SHOCK HAZARDS, DO NOT EXPOSE THIS PRODUCT TO RAIN OR MOISTURE.

POWER CORD POLARIZATION:

CAUTION: TO PREVENT ELECTRIC SHOCK, MATCH WIDE BLADE OF PLUG TO WIDE SLOT, FULLY INSERT.

ATTENTION: POUR ÉVITER LES CHOCS ÉLECTRIQUES, INTRODUIRE LA LAME LA PLUS LARGE DE LA FICHE DANS LA BORNE CORRESPONDANTE DE LA PRISE ET POUSSER JUSQU'AU FOND.

NOTE TO CABLE/TV INSTALLER:

This reminder is provided to call the CATV system installer's attention to Article 820-40 of the National Electric Code (U.S.A.). The code provides guidelines for proper grounding and, in particular, specifies that the cable ground shall be connected to the grounding system of the building, as close to the point of the cable entry as practical.

REGULATORY INFORMATION:

This equipment, trade name Zenith, model number, R49W36/R56W36, has been tested and found to comply with the limits for a Class B digital device, pursuant to Part 15 of the FCC Rules. These limits are designed to provide reasonable protection against harmful interference when the equipment is operated in a residential installation. This equipment generates, uses and can radiate radio frequency energy and, if not installed and used in accordance with the instruction manual, may cause harmful interference to radio communications. However, there is no guarantee that interference will not occur in a particular installation. If this equipment does cause harmful interference to radio or television reception, which can be determined by turning the equipment off and on, the user is encouraged to try to correct the interference by one or more of the following measures:

- Reorient or relocate the receiving antenna.
- Increase the separation between the equipment and receiver.
- Connect the equipment into an outlet on a circuit different from that to which the receiver is connected.
- Consult the dealer or an experienced radio/TV technician for help.

Any changes or modifications not expressly approved by the party responsible for compliance could void the user's authority to operate the equipment.

The responsible party for this device compliance is:

Zenith Electronics Corporation
2000 Millbrook Drive
Lincolnshire, IL 60069

Digital TV Hotline:
1-847-941-8000

CAUTION:

Do not attempt to modify this product in any way without written authorization from Zenith Electronics Corporation. Unauthorized modification could void the user's authority to operate this product.

©2003 Zenith Electronics Corporation. All rights reserved.

IMPORTANT SAFETY INSTRUCTIONS

Important safeguards for you and your new product

Your product has been manufactured and tested with your safety in mind. However, improper use can result in electrical shock or fire hazards. To avoid defeating the safeguards that have been built into your new product, please read and observe the following safety points when installing and using your new product, and save them for future reference.

Observing the simple precautions discussed in this manual can help you get many years of enjoyment and safe operation that are built into your new product.

This product complies with all applicable U.S. Federal safety requirements, and those of the Canadian Standards Association.

1. Read Instructions

All the safety and operating instructions should be read before the product is operated.

2. Follow Instructions

All operating and use instructions should be followed.

3. Retain Instructions

The safety and operating instructions should be retained for future reference.

4. Heed Warnings

All warnings on the product and in the operating instructions should be adhered to.

5. Cleaning

Unplug this product from the wall outlet before cleaning. Do not use liquid cleaners or aerosol cleaners. Use a damp cloth for cleaning.

6. Water and Moisture

Do not use this product near water, for example, near a bath tub, wash bowl, kitchen sink, or laundry tub, in a wet basement, or near a swimming pool.

7. Accessories, Carts, and Stands

Do not place this product on a slippery or tilted surface, or on an unstable cart, stand, tripod, bracket, or table. The product may slide or fall, causing serious injury to a child or adult, and serious damage to the product. Use only with a cart, stand, tripod, bracket, or table recommended by the manufacturer, or sold with the product. Any mounting of the product should follow the manufacturer's instructions, and should use a mounting accessory recommended by the manufacturer.

8. Transporting Product

A product and cart combination should be moved with care. Quick stops, excessive force, and uneven surfaces may cause the product and cart combination to overturn.



PORTABLE CART WARNING

206-03865

9. Attachments

Do not use attachments not recommended by the product manufacturer as they may cause hazards.

10. Ventilation

Slots and openings in the cabinet are provided for ventilation and to ensure reliable operation of the product and to protect it from overheating, and these openings must not be blocked or covered. The openings should never be blocked by placing the product on a bed, sofa, rug, or other similar surface. This product should not be placed in a built-in installation such as a bookcase or rack unless proper ventilation is provided or the manufacturer's instructions have been adhered to.

11. Power Sources

This product should be operated only from the type of power source indicated on the marking label. If you are not sure of the type of power supply to your home, consult your product dealer or local power company. For products intended to operate from battery power, or other sources, refer to the operating instructions.

12. Power-Cord Polarization

This product is equipped with a polarized alternating-current line plug (a plug having one blade wider than the other). This plug will fit into the power outlet only one way. This is a safety feature. If you are unable to insert the plug fully into the outlet, try reversing the plug. If the plug should still fail to fit, contact your electrician to replace your obsolete outlet. Do not defeat the safety purpose of the polarized plug.

13. Power-Cord Protection

Power-supply cords should be routed so that they are not likely to be walked on or pinched by items placed upon or against them, paying particular attention to cords at plugs, convenience receptacles, and the point where they exit from the product.

(Continued on next page)

IMPORTANT SAFETY INSTRUCTIONS

(Continued from previous page)

14. Outdoor Antenna Grounding

If an outside antenna or cable system is connected to the product, be sure the antenna or cable system is grounded to provide protection against voltage surges and built-up static charges. Article 810 of the National Electrical Code (U.S.A.), ANSI/ NFPA 70 provides information with regard to proper grounding of the mast and supporting structure, grounding of the lead-in wire to an antenna discharge unit, size of grounding conductors, location of antenna-discharge unit, connection to grounding electrodes, and requirements for the grounding electrode.

Example of Grounding According to National Electrical Code Instructions

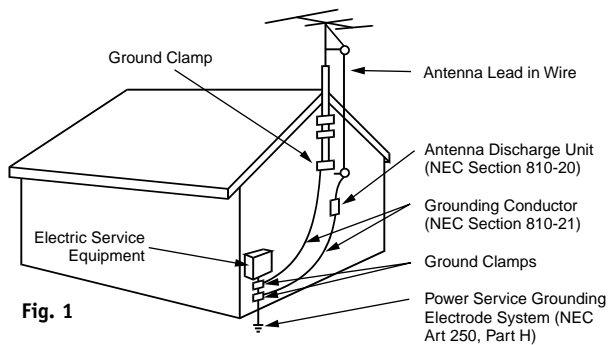

15. Lightning

For added protection for this product (receiver) during a lightning storm, or when it is left unattended and unused for long periods of time, unplug it from the wall outlet and disconnect the antenna or cable system. This will prevent damage to the product due to lightning and power-line surges.

16. Power Lines

An outside antenna system should not be located in the vicinity of overhead power lines or other electric light or power circuits, or where it can fall into such power lines or circuits. When installing an outside antenna system, extreme care should be taken to keep from touching such power lines or circuits as contact with them might be fatal.

17. Overloading

Do not overload wall outlets and extension cords as this can result in a risk of fire or electric shock.

18. Object and Liquid Entry

Never push objects of any kind into this product through

openings as they may touch dangerous voltage points or short-out parts that could result in a fire or electric shock. Never spill liquid of any kind on the product.

19. Servicing

Do not attempt to service this product yourself as opening or removing covers may expose you to dangerous voltage or other hazards. Refer all servicing to qualified service personnel.

20. Damage Requiring Service

Unplug this product from the wall outlet and refer servicing to qualified service personnel under the following conditions:

- If the power-supply cord or plug is damaged.
- If liquid has been spilled, or objects have fallen into the product.
- If the product has been exposed to rain or water.
- If the product does not operate normally by following the operating instructions. Adjust only those controls that are covered by the operating instructions as an improper adjustment of other controls may result in damage and will often require extensive work by a qualified technician to restore the product to its normal operation.
- If the product has been dropped or the cabinet has been damaged.
- If the product exhibits a distinct change in performance.

21. Replacement Parts

When replacement parts are required, be sure the service technician has used replacement parts specified by the manufacturer or have the same characteristics as the original part. Unauthorized substitutions may result in fire, electric shock, or other hazards.

22. Safety Check

Upon completion of any service or repairs to this product, ask the service technician to perform safety checks to determine that the product is in proper operating condition.

23. Wall or Ceiling Mounting

The product should be mounted to a wall or ceiling only as recommended by the manufacturer. The product may slide or fall, causing serious injury to a child or adult, and serious damage to the product.

24. Heat

The product should be situated away from heat sources such as radiators, heat registers, stoves, or other products (including amplifiers) that produce heat.

Table of Contents

Safety Warnings	2	SPECIAL Menu	
Important Safety Instructions	3-4	On-Screen Menus Language	32
Step 1. Hook Up TV		Main Picture Source Selection	33
Front Controls Panel	6	PIP (Picture-In-Picture) Options	34
Rear Connections Panel	7	POP (Picture-out-of-Picture) Source	35
Front Connections Panel	8	Twin Picture	36
ANT/CABLE Service Hookup	9	Captions	37
CABLE BOX Connections	10	Captions/Text	38
VCR Connections	11	Aspect Ratio Control	39
DVD Player	12	Key Lock	40
DBS Input	13	Auto Convergence	41
Monitor Out Setup	14	Auto Move	42
Turning the TV on	15	LOCK Menu	
On-Screen Displays	15	Parental Lock Setup	43-45
Remote Control Functions In TV Mode	16-17	Step 3. Miscellaneous	
Step 2. Customize your TV's Features		Programming the Remote	46
SETUP Menu		Programming Codes	47-50
EZ Scan (Channel Search)	18	Maintenance	51-52
Channel Edit	19	Troubleshooting	53-54
Fine Tuning Adjustment	20	Glossary	55-56
VIDEO Menu	21-23	Product Specifications	57
AUDIO Menu	24-25	Notes	58-59
TIME Menu		Warranty	Back cover
Auto Clock Setup	26		
Manual Clock Setup	27		
TV Turn Off Time Setup	28		
TV Turn On Time Setup	29		
Sleep Timer Setup	30		
Auto off	31		

Front Panel Controls

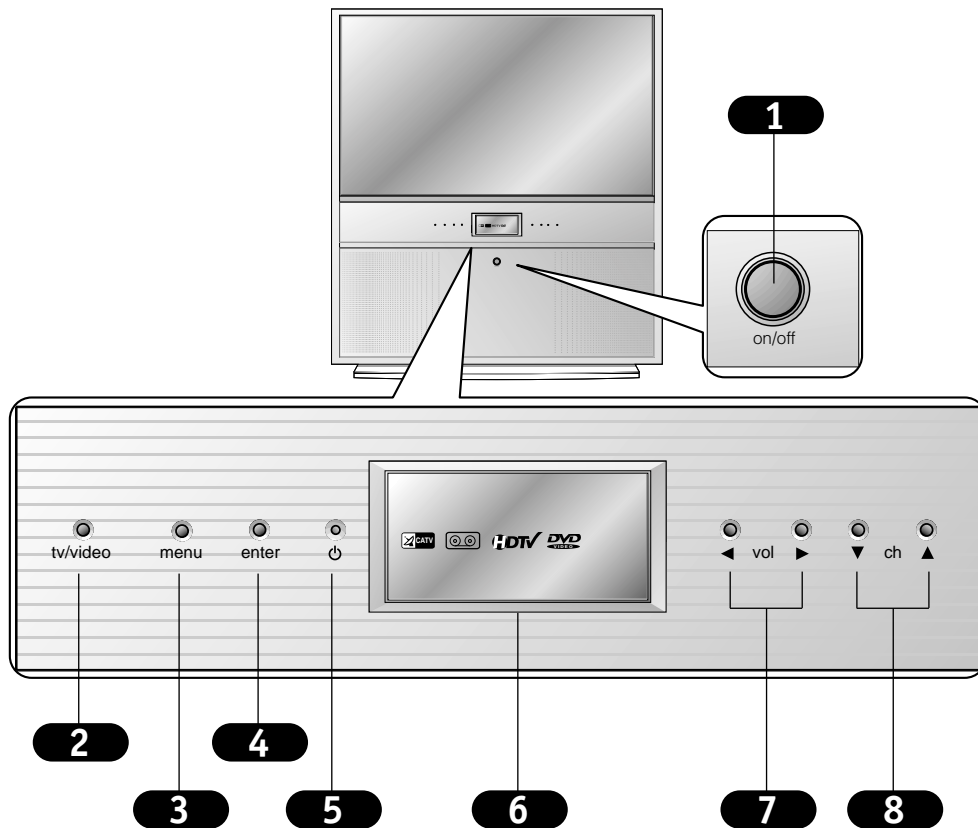

1 On/Off

2 TV/VIDEO

3 Menu

4 Enter

5 Standby indicator (Illuminates brightly when the TV is in standby mode. Dims when the TV is switched on.)

6 LED (Light Emitting Diodes) Displays
Illuminate brightly when the set is switched on.
LEDs light when source is selected or feature is present.

7 VOLUME UP / DOWN
Volume (▶) button increases the level of sound and
volume (◀) button decreases the level of sound.

8 CHANNEL UP / DOWN

 These buttons work just as they do on your remote control.

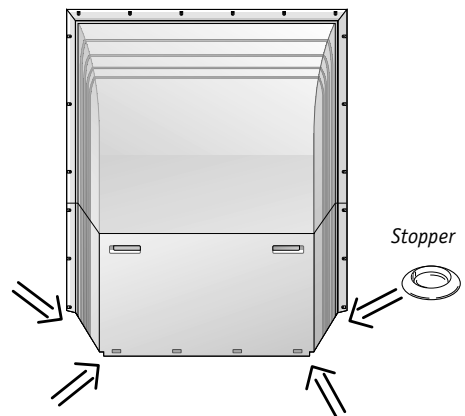

 Casters (On the bottom)
Turn and move the TV easily.

 To fix TV's position, install the 4 stoppers under the roller casters to prevent the TV from being moved.

Rear Connections Panel

Connecting cables to your TV.

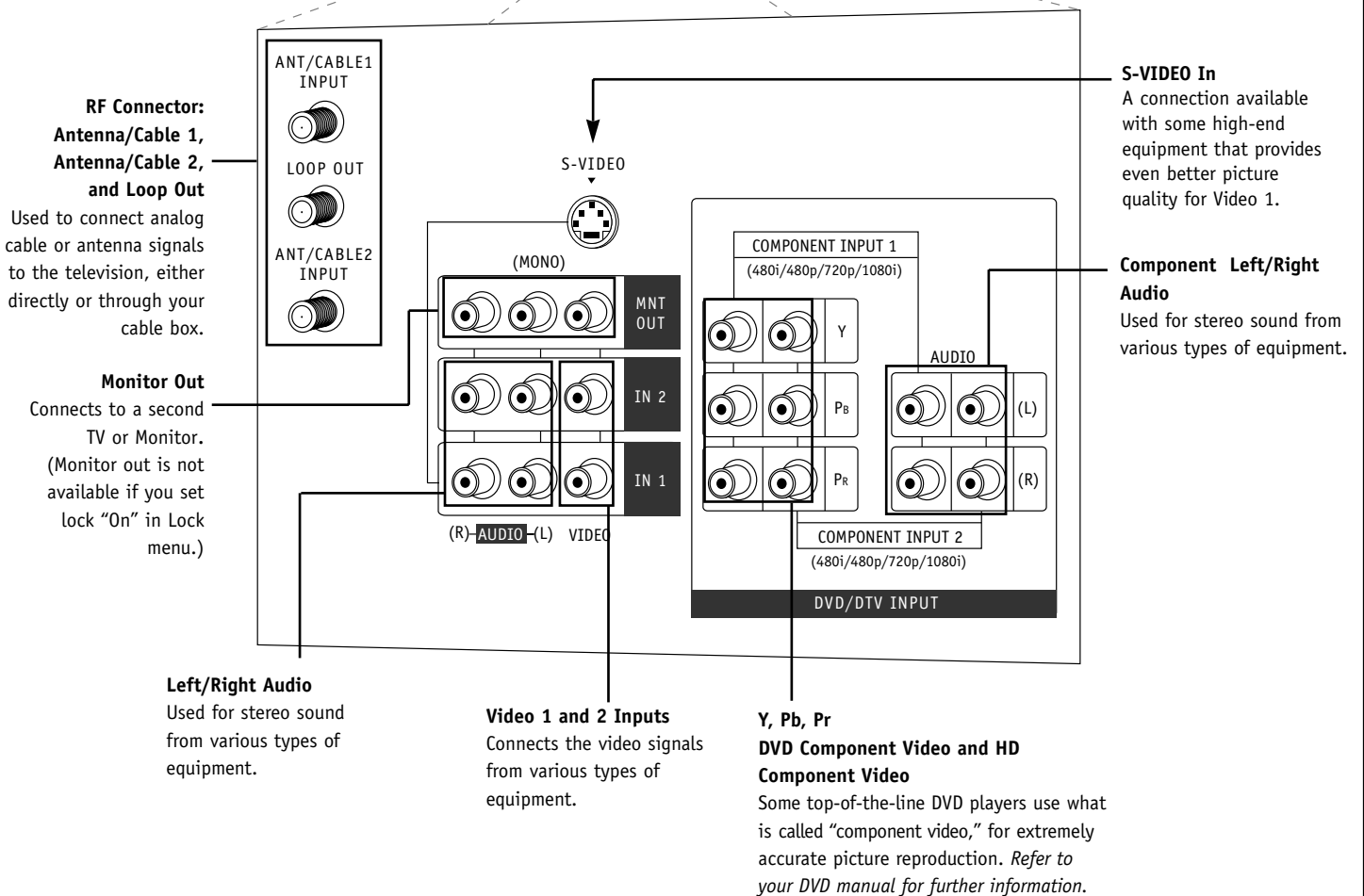
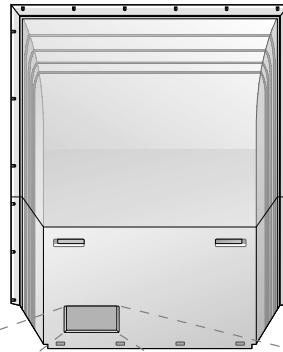

Mini glossary

- JACK** A connection on the back of a TV, VCR, or any other A/V device. This includes the RF jack and the Audio/Video jacks that are color-coded.
- SIGNAL** Picture and sound traveling through cable, or over the air, to your television screen.

Front Connection Panel (Video 3)

There are four jacks on the right front side behind the screen on your projection TV that make connecting Audio/Video devices like video games and camcorders very simple.

The jacks are like those found on the back jack connection panel. This means that most equipment that connects to those types of jacks on the rear jackpack, may be connected to the front connection panel (Video3).

To use the front jacks as the signal source, select them using Main Source menu as described on page 33. They will be named "Video 3" in the Main Source menu.



When you select Video3 (Front Video or Front S-Video, the Front audio) inputs are automatically selected as well.

CAUTION: Do not connect to both Video and S-Video at the same time. Connect either Video or S-Video only.

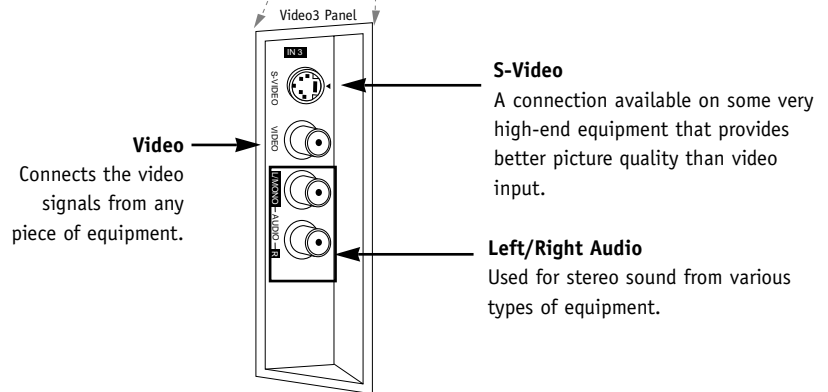
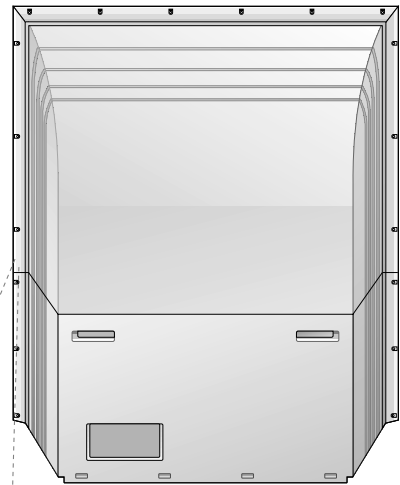

Mini glossary

A/V CABLES Audio/Video cables. Three cable connector—Right audio (red), Left audio (white), and Video (yellow). A/V cables are used for stereo playback of videocassettes and for higher quality picture and sound from other A/V devices.

A/V DEVICE Any device that produces video (picture) and/or audio (sound) (VCR, DVD, cable box, or television).

ANT / Cable Service Hookup

1

Connect an antenna and/or cable service to your TV as shown.

2

Turn to page 18 to do a channel search with EZ Scan for ANT / CABLE connection(s).

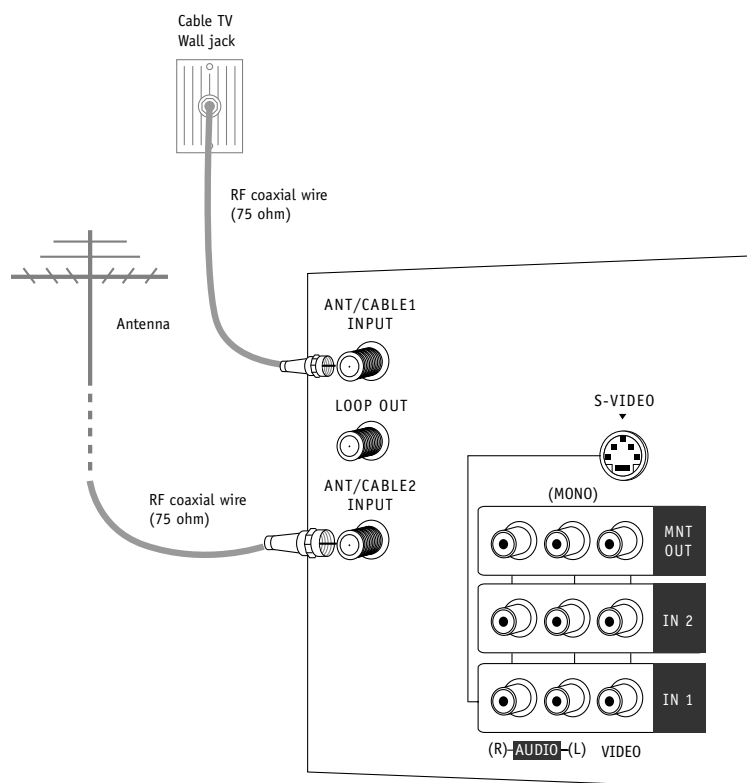

If you receive your RF signal through an antenna that is several years old and connects with two small prongs, you will need to purchase a 300 to 75 ohm adapter. It should be available from your local electronics dealer.



Zenith recommends using a 75 ohm cable for your antenna connections in order to prevent interference.

For best signal reception, it is recommended to have your Antenna professionally adjusted.

Cable Box Connections

Some cable services require the use of a cable box to decode premium channels and pay-per-view. Using the Loop Out to Decoder connection option, and programming your remote, you can connect your cable box so that you only need your MBR remote to tune to premium and non-premium channels. By connecting a cable box directly to your TV, as shown to the LOOP OUT, you make the cable box another available channel tuning source using your remote.

- 1 Locate the Antenna/Cable 2 jack on the back of your TV. Connect the cable that runs from the wall directly or antenna to the jack. Now find the Loop Out jack.
- 2 Connect the cable from this jack to the Input jack on the back of your cable box.
- 3 Locate the Output jack on the back of your cable box. Connect this to the Antenna/Cable 1 jack on the back of your TV.
- 4 To view the premium stations, press the TV/VIDEO button on your remote and select the other Cable source (Ant/Cable 1). Then tune the channel number on your cable box for HBO, CINEMAX, SHOW-TIME, etc.

To view non-premium channels press the TV/VIDEO button and select Ant/Cable 2. Then run EZ Scan to find all available channels and store them in memory.

This can be combined with any other equipment you may want to hook up, see following pages. Connect cable service wire directly to the TV, loop out from the TV, then to the cable box. From there, the cable box output connects to the next device in the connection series, until the last device, which connects back to the Antenna/Cable 1 jack on the TV.

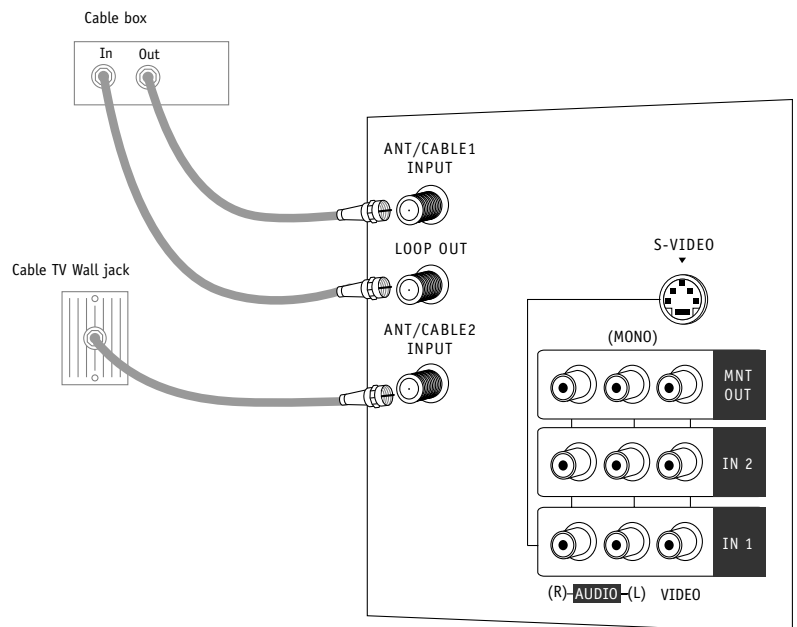

VCR Connections

1 Locate the Antenna/Cable 2 jack on the back of your TV. Connect the cable that runs from the wall or antenna to the jack.
Now find the Loop Out jack.

2 Connect the cable from this jack to the Input jack on the back of your cable box.

3 Locate the Output jack on the back of your cable box. Connect this to the RF or VHF/UHF/CATV In jack on the back of your VCR.
If you want to connect VCR to the TV directly, connect the cable from the Loop Out jack to the RF or VHF/UHF/CATV In jack on the back of your VCR.

4 Find the composite video and audio jacks on the back of your VCR, and connect them following the instructions provided with your equipment.

You may connect either the composite video or the S-Video cables to your TV. (Do not connect BOTH the composite video and the S-Video cables. In the event that you connect both composite video and the S-Video cables, only the S-Video will work.)

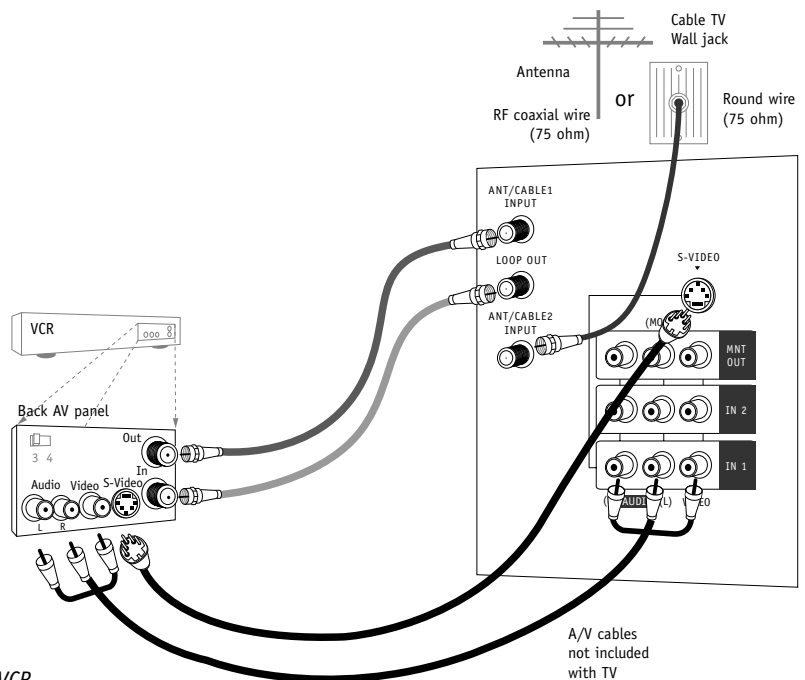
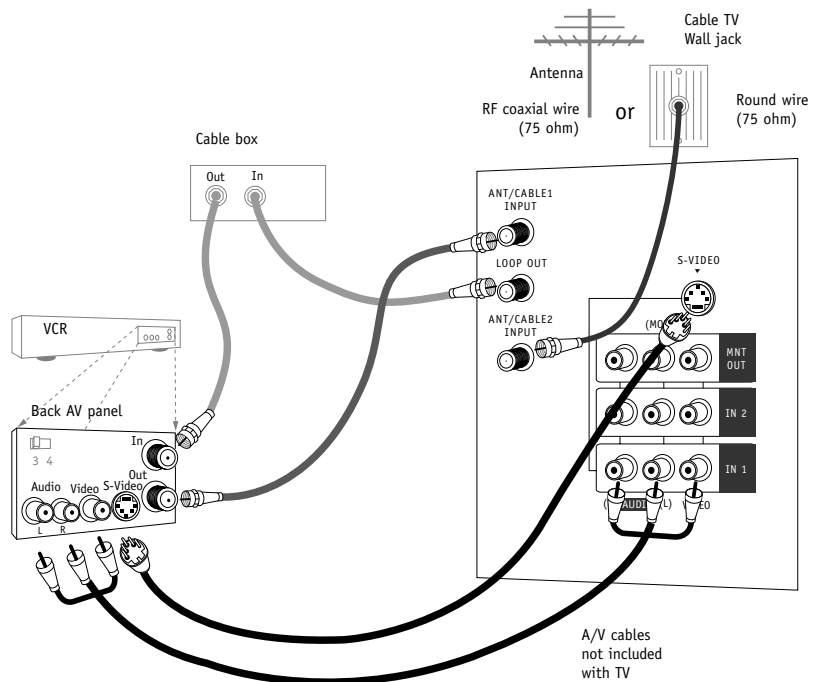

To hear stereo sound from cable or your VCR, you will need to connect A/V cables as well as the wire that runs from the VCR to your TV.



If you want to receive your signals on Channel 3 or 4, locate the Out to TV jack on your VCR. Connect a cable from the Out to TV jack to the Antenna/Cable 1 jack on the back of your TV.



After connecting external equipment to the TV, don't display a still picture for a long time on the screen. Doing so may damage the TV screen.

DVD Player

1

Find the audio and component or S-Video jacks on the back of your DVD Player and connect them following the instructions provided with your equipment.

2

You may connect either the composite video or the S-Video cables to your TV. Do not connect both the composite and the S-Video.

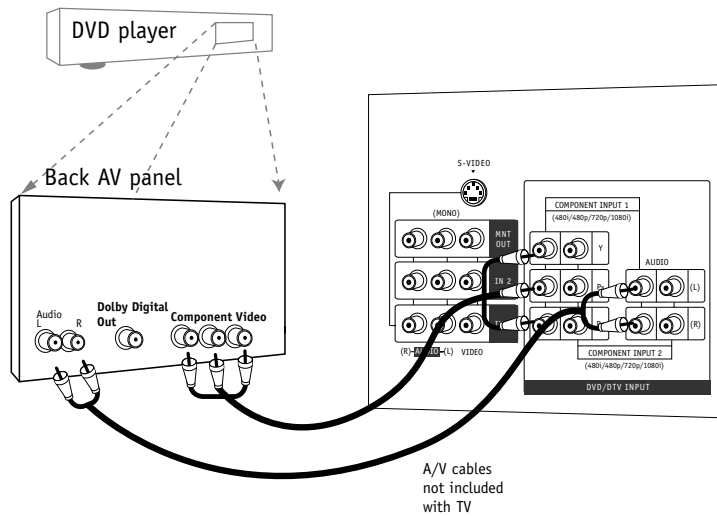

Some high-end DVD players use a picture reproduction system called "component video." If your DVD player has component output, use the connector marked "COMPONENT 1/2" on the jack panel. Please refer to your DVD manual for proper installation.

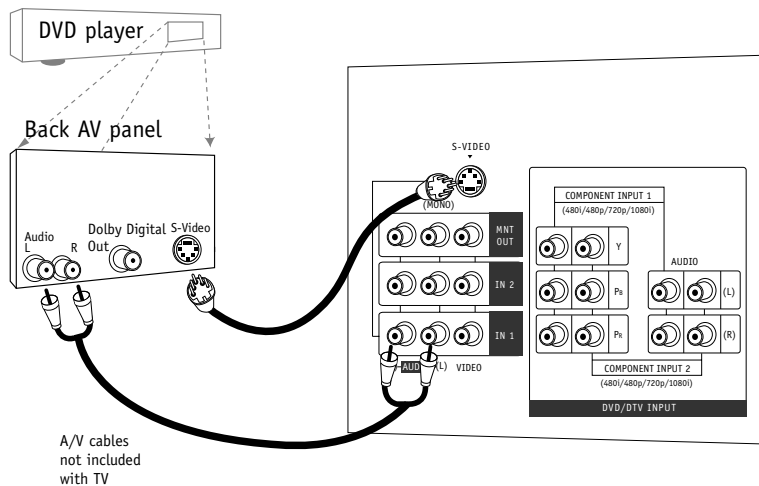

Component 1 (or 2) Input

Y	P _B	P _R
1920X1080i		
1280X720p		
720X480p		
720X480i		

• Component Input ports

You can get better picture quality if you connect DVD player with component input ports as below.

Component input jacks on the Monitor	Y	P _B	P _R
Video output jacks of DVD player	Y	P _B	P _R
	Y	B-Y	R-Y
	Y	C _b	C _r
	Y	P _B	P _R

Mini glossary

COMPONENT VIDEO Some video equipment uses three separate lines (Y, P_B, P_R) to more precisely reproduce images. Your manual will explain how this relates to your equipment.

DBS Hookup

1 Find the audio and Y, P_B, P_R jacks on the back of your DBS receiver and connect them following the instructions provided with your equipment.

2 Connect these cables to your TV as shown.

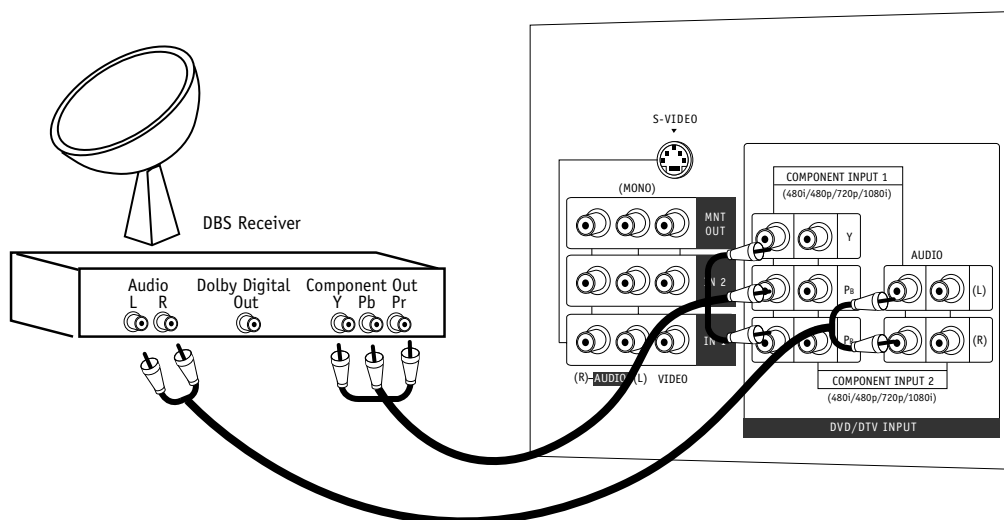

The DTV shows the sharpest picture in 720p mode.



To watch DTV, connect a HD-SET TOP box to COMPONENT INPUT1 or 2 of your TV.

Mini glossary

DBS (Direct Broadcast Satellite), receives TV signals from a satellite.

DTV (Digital TV), receives digital program signals and turns them into picture and sound.

Monitor Out Setup

1

Your TV has a special signal output capability which allows you to hook up a second TV or monitor.

2

Just connect the second TV or monitor to the MNT OUT Audio/Video jacks located on the back of your TV. See the Operating Manual of the second TV or monitor for further details regarding that device's input settings.

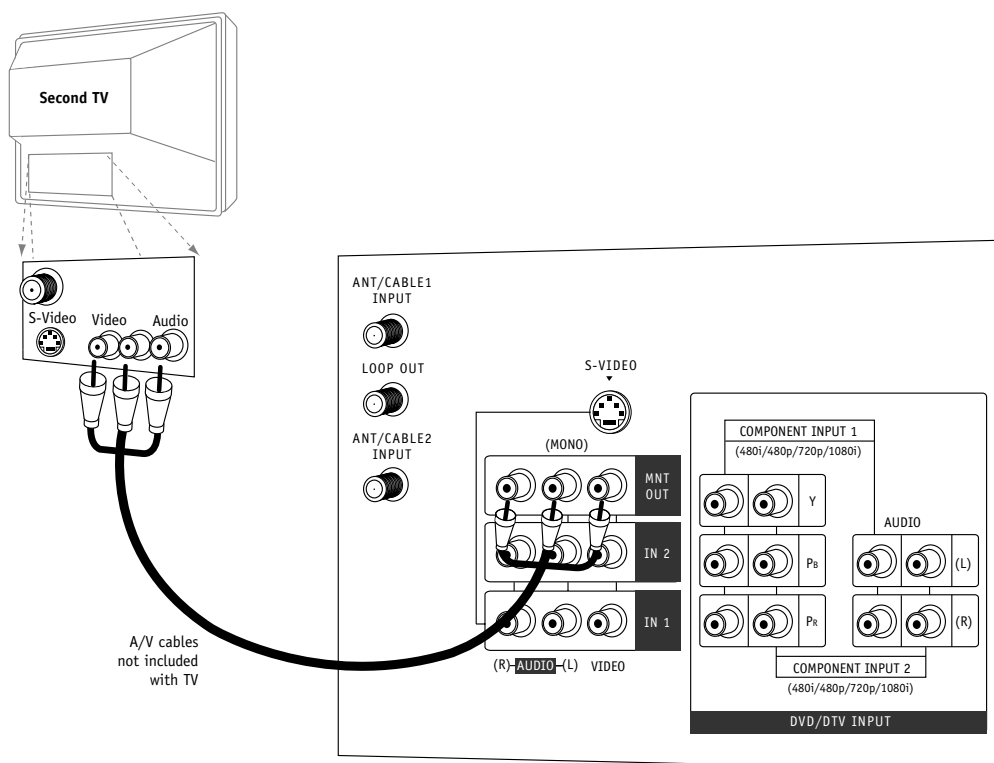

Component 1 - 2 input sources for main picture cannot be used for Monitor Out.



Monitor Out is not available if you set lock "On" in Lock menu.

Turning the TV On

- 1** First, connect antenna cable and power cord correctly. At this moment, the TV switches to standby mode.
In standby mode to turn TV on, press the POWER, CH UP/DOWN, TV/VIDEO, COMP or number buttons on the remote control or ON/OFF, CH UP/DOWN or ENTER on the TV.
- 2** Select the viewing source by using TV/VIDEO or COMP on the remote control.
This TV is programmed to remember which mode it was last set to, even if you turn the TV off.
Note: See page 18 if you have not auto programmed the TV to receive channels in your local broadcast area.
- 3** When finished using the TV, press the POWER button on the remote control. The TV reverts to standby mode.



If you will be away on vacation, disconnect the power plug from the wall power outlet.

On-Screen Displays

This page describes your on-screen display and information banner options.

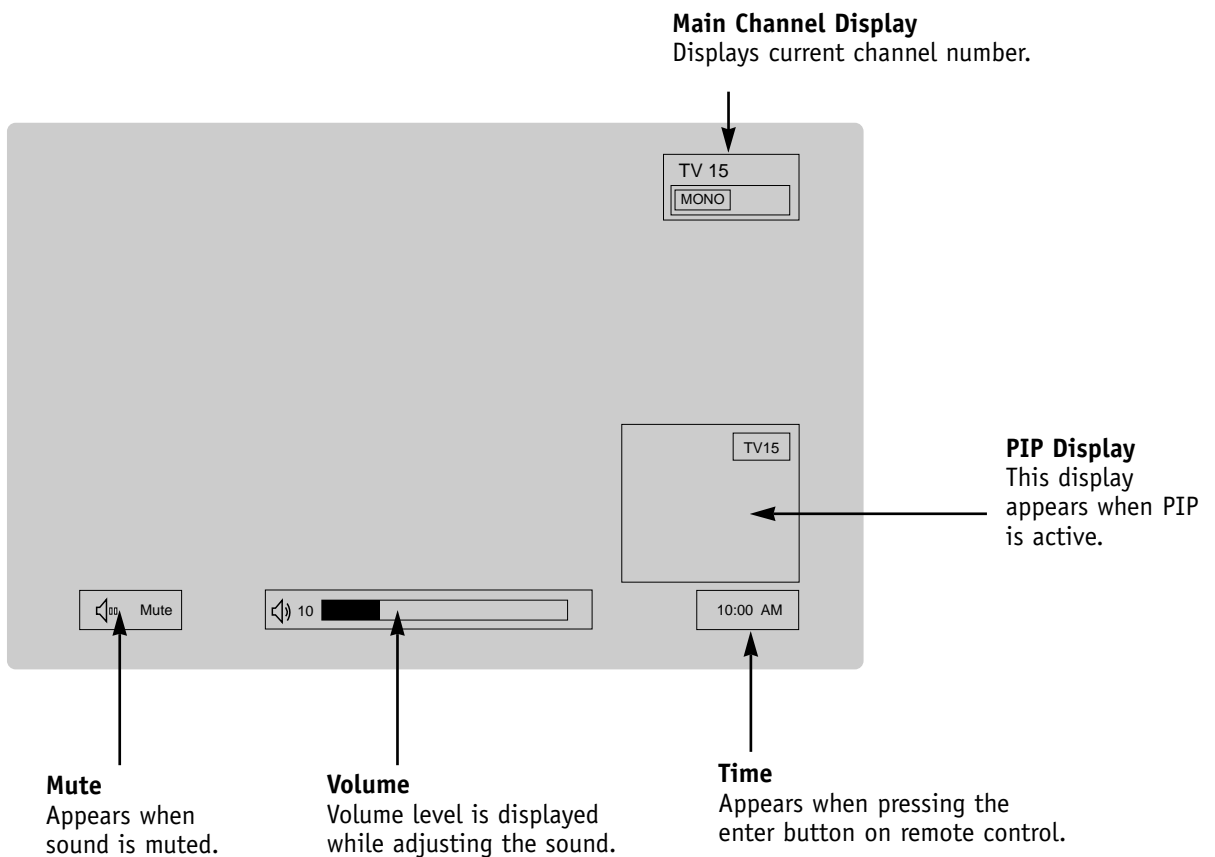

Remote Control Functions in TV Mode

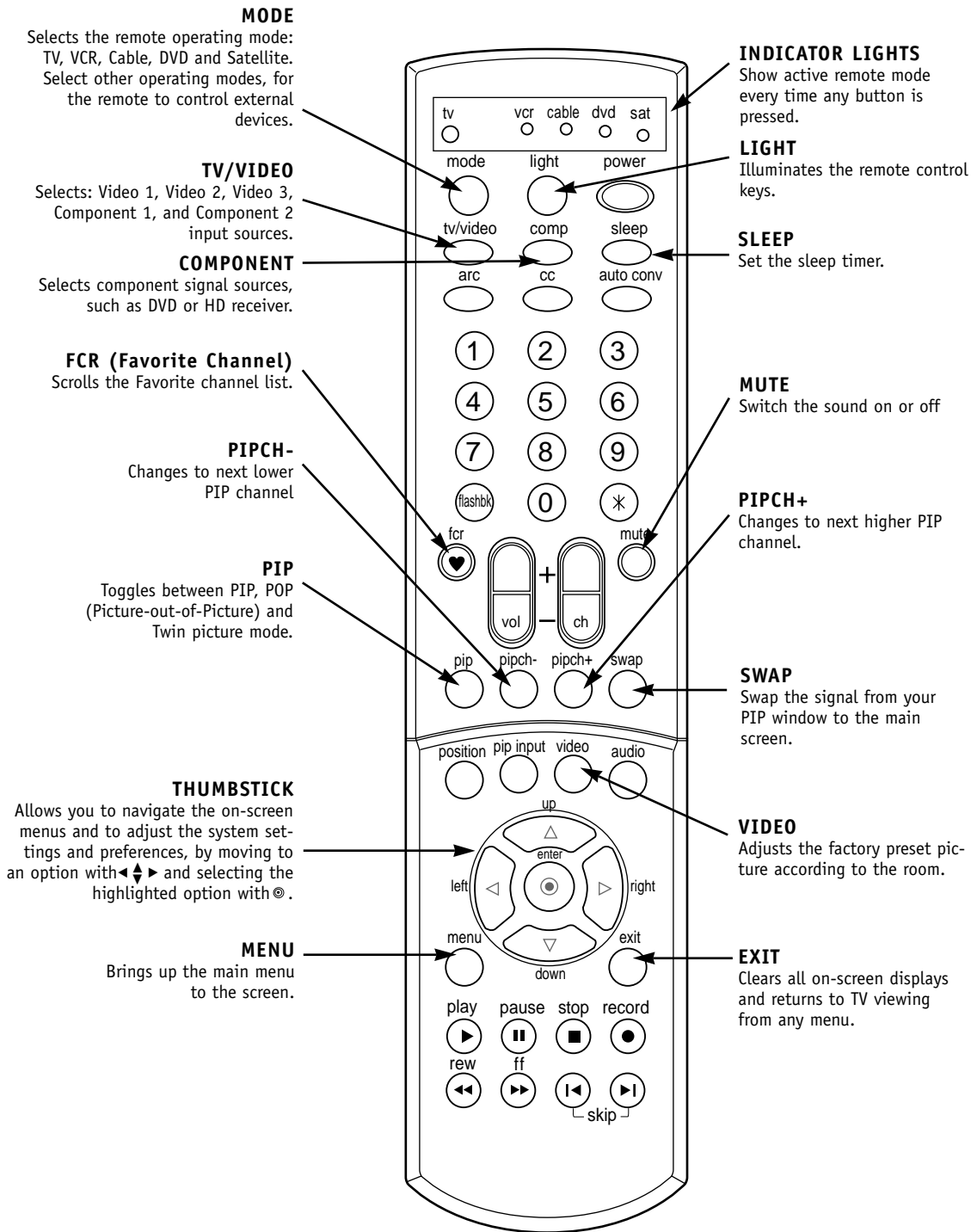

Remote Control Functions in TV Mode

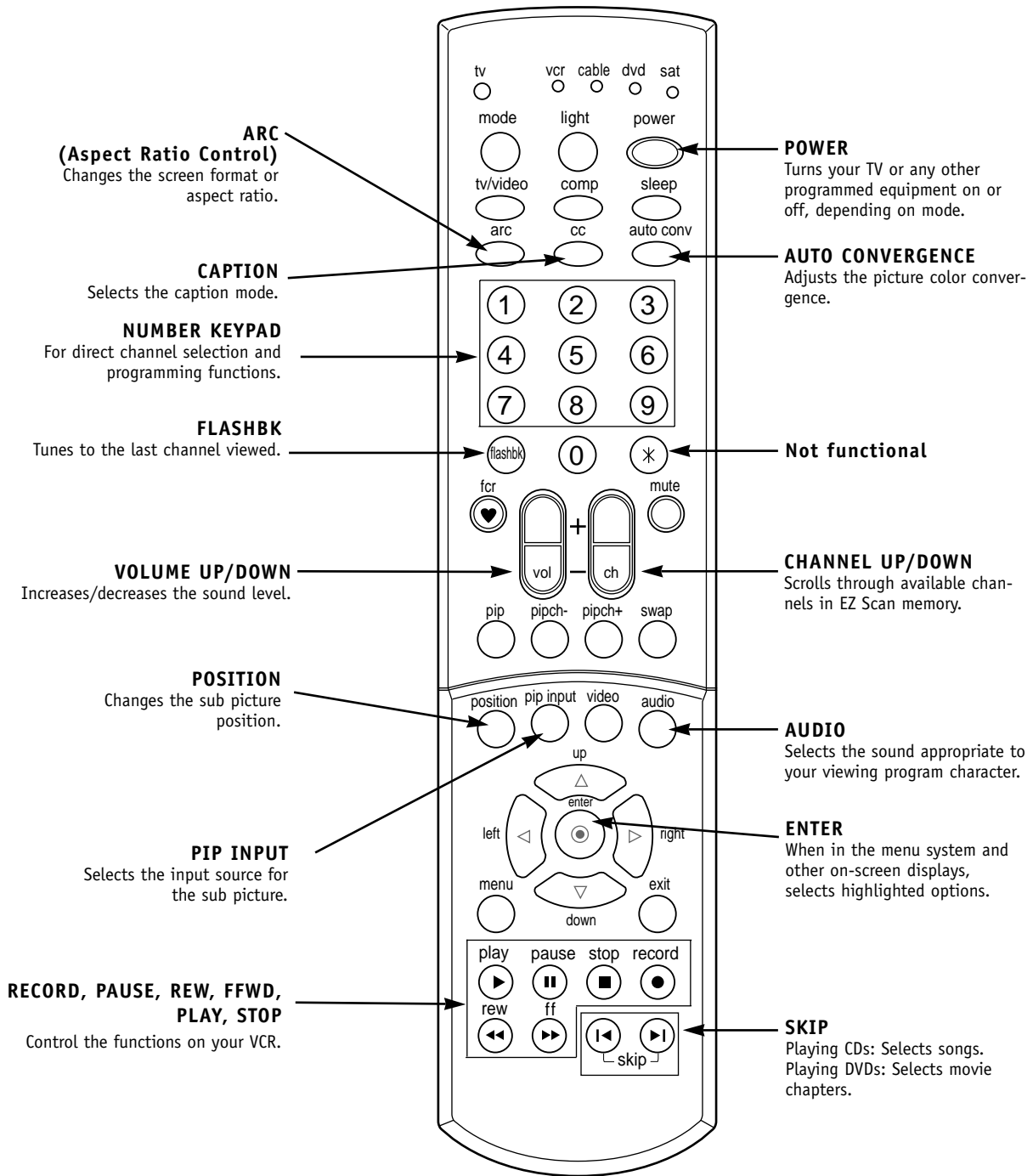

EZ Scan

Automatically finds all channels available through antenna or cable inputs, and stores them in memory on the channel list.

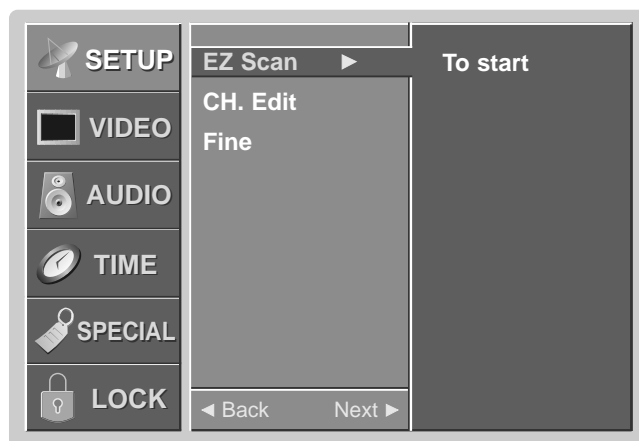

1

Use pages 9-13 to connect external equipment to your TV. If you have not done so, plug in your TV to a standard 120V 60Hz power outlet.

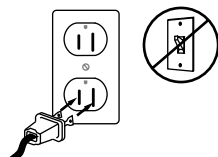

2

If you have not done so, remove the back of the remote and put in two AA batteries. Make sure batteries are properly installed (check the +/- symbols).

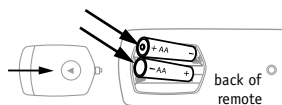

3

With the remote control in hand, press the POWER button to turn on your TV.

4

Press the MENU button on the remote control, then use the UP/DOWN arrow button to select the Setup menu.

5

Press the RIGHT arrow button to access the Setup menu.

6

Use the UP/DOWN arrow button to select EZ Scan.

7

Press the RIGHT arrow to start the EZ Scan channel search.

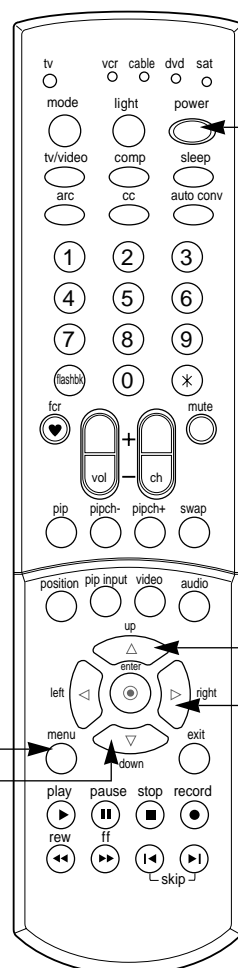

CH. Edit

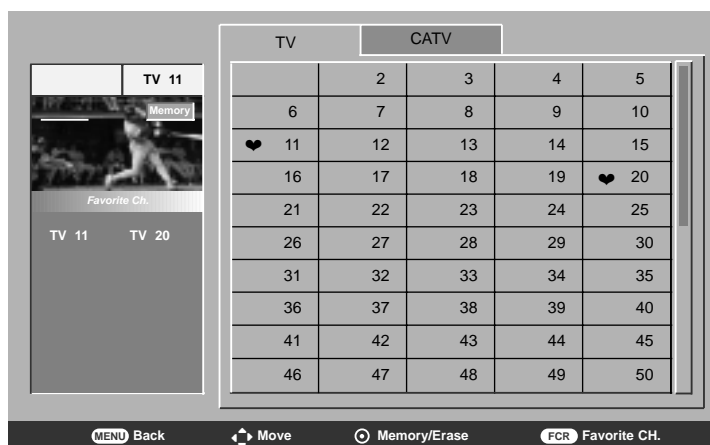
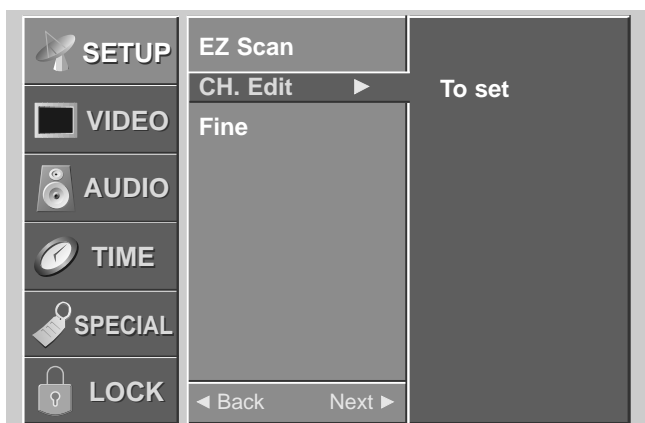

Create two different types of channel lists in memory: "Custom list" and "Favorite channel list" from the default channel list made in the EZ SCAN menu.

A custom list can be created by toggling each channel on or off with **Enter**. Once a channel is highlighted, you will be able to see whether the channel is currently added or deleted by referring to the small window at the top-left corner of the screen.

You can create your own Favorite channel list with up to 10 channels. It appears at the bottom-left corner of the screen.

Use the FCR button on the remote control when a channel is highlighted, to add or delete the channel in the Favorite channel list.

- 1** Press the MENU button on the remote control, then use the UP/DOWN arrow button to select the Setup menu.
- 2** Press the RIGHT arrow button to access the Setup menu.
- 3** Use the UP/DOWN arrow button to select CH.Edit and then press the RIGHT arrow button.
- 4** You will now see a screen filled with channel numbers and a preview picture. Use the UP/DOWN and LEFT/RIGHT arrow button to select a channel, then use the **Enter** button to add or delete it. Press FCR to add the channel to the Favorite channel List.
- 5** Press EXIT button to save and return to TV viewing or press MENU button to save and return to the previous menu.

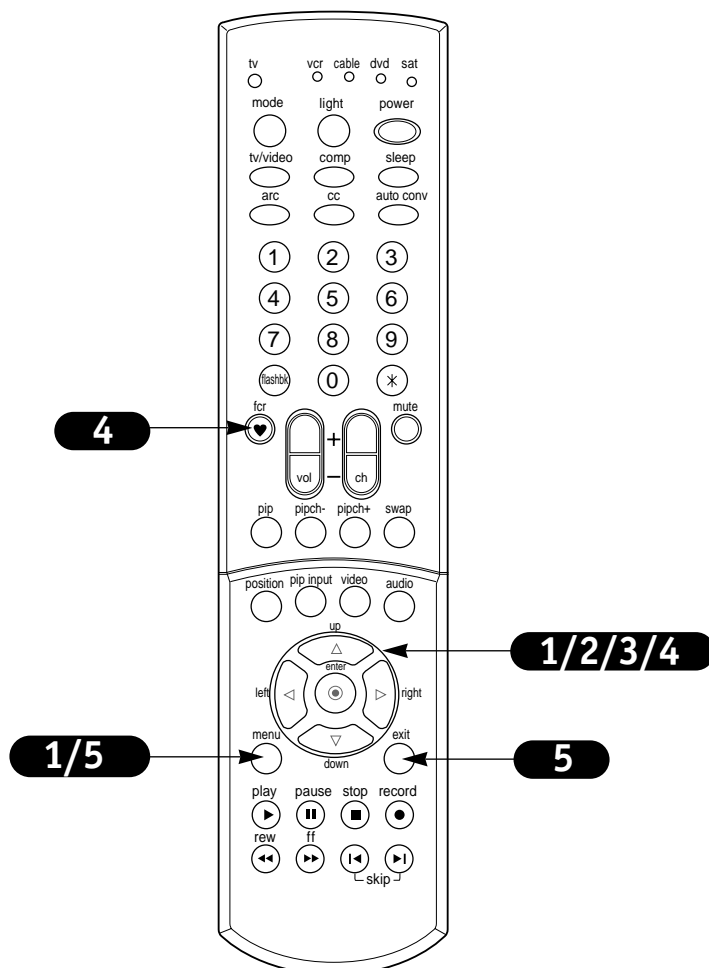

Fine Tuning Adjustment

Use Fine to correct poor picture appearance, for example, a horizontal stripe, twisted picture or no color in program.

When a finely tuned channel is memorized, the color of the channel number changes to yellow.

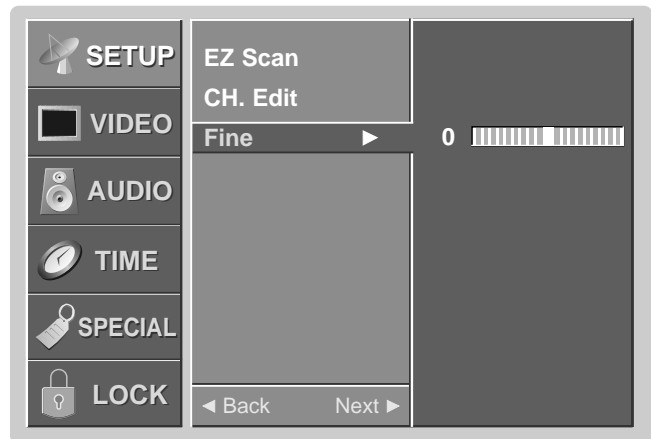

- 1** Press the MENU button on the remote control, then use the UP/DOWN arrow button to select the Setup menu.
- 2** Press the RIGHT arrow button to access the Setup menu.
- 3** Use the UP/DOWN arrow button to select Fine, then press the RIGHT arrow button.
- 4** Use the LEFT/RIGHT arrow button to adjust the picture appearance to your preference.
- 5** Press EXIT button to save and return to TV viewing or press MENU button to save and return to the previous menu.

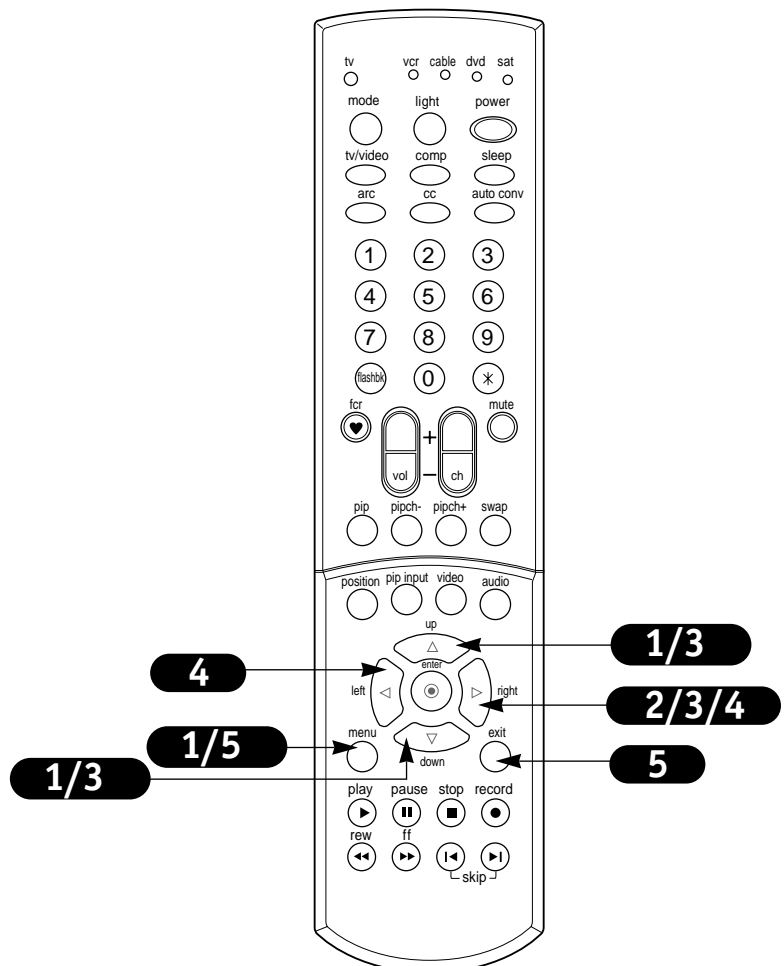

VIDEO Menu

EZ Video

This function adjusts the TV to the best picture appearance. Select the preset value in the EZ Video menu based on the program category. Video options (clear, optimum, and soft) are preset for good picture quality at the factory and cannot be changed. When adjusting video options (Contrast, Brightness, Color, Sharpness, and Tint) manually, EZ Video automatically changes to 'Off'.

- 1 Use the VIDEO button to select EZ video option.
Each press of the VIDEO button change the EZ video option: Clear, Optimum, Soft and Off.

- 2 Press EXIT to save and return to TV viewing.



You can also select EZ Video in the Video menu.



Velocity Modulation

Use this function to improve the outline distinction of the picture's edges.

If you select VM 'off', the TV will automatically return the pictures' edge appearance to factory settings.

- 1 Press the MENU button on the remote control, then use the UP/DOWN arrow button to select the Video menu.
- 2 Press the RIGHT arrow button to access the Video menu.
- 3 Use the UP/DOWN arrow button to select VM, and then press the RIGHT arrow button.
- 4 Use the UP/DOWN arrow button to select Off, Low, Medium, and High.
- 5 Press EXIT button to save and return to TV viewing or press MENU button to save and return to the previous menu.

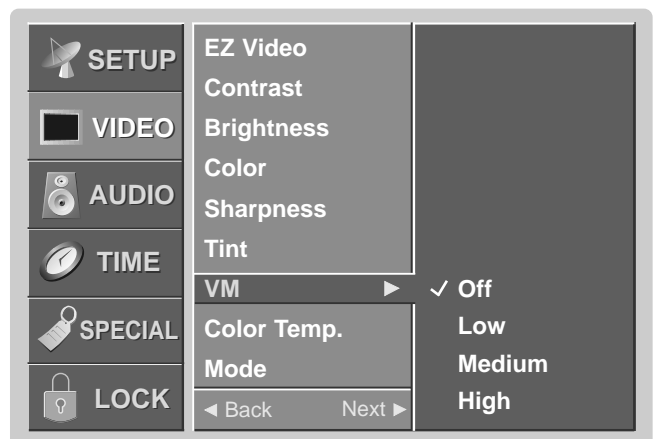

VIDEO Menu

Adjust the picture appearance to suit your preference and viewing situations.

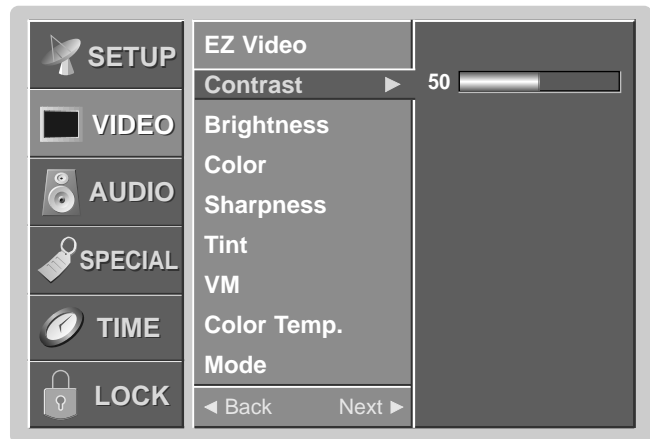

You can manually adjust the levels of picture quality settings, such as Contrast, Brightness, Sharpness, etc.

1

Press the MENU button on the remote control, then use the UP/DOWN arrow button to select the Video menu.

2

Press the RIGHT arrow button to access the Video menu.

3

Use the UP/DOWN arrow button to select one of the following options: Contrast, Brightness, Sharpness, Color, and Tint, then press the RIGHT arrow button.

- **Contrast** Adjusts the difference between the light and dark levels of the picture. Press the right arrow button to activate adjusting.
- **Brightness** Adjusts the white or light level of the overall picture.
- **Color** Adjusts the intensity of all colors.
- **Sharpness** Adjusts the level of crispness in the edges between the light and dark areas of the picture. The lower the level, the softer the image.
- **Tint** Adjusts the balance between the red and green levels.

4

Use the LEFT/RIGHT arrow button to adjust the option to your preference. Use the UP/DOWN arrow button to select another option.

5

Press EXIT button to save and return to TV viewing or press MENU button to save and return to the previous menu.

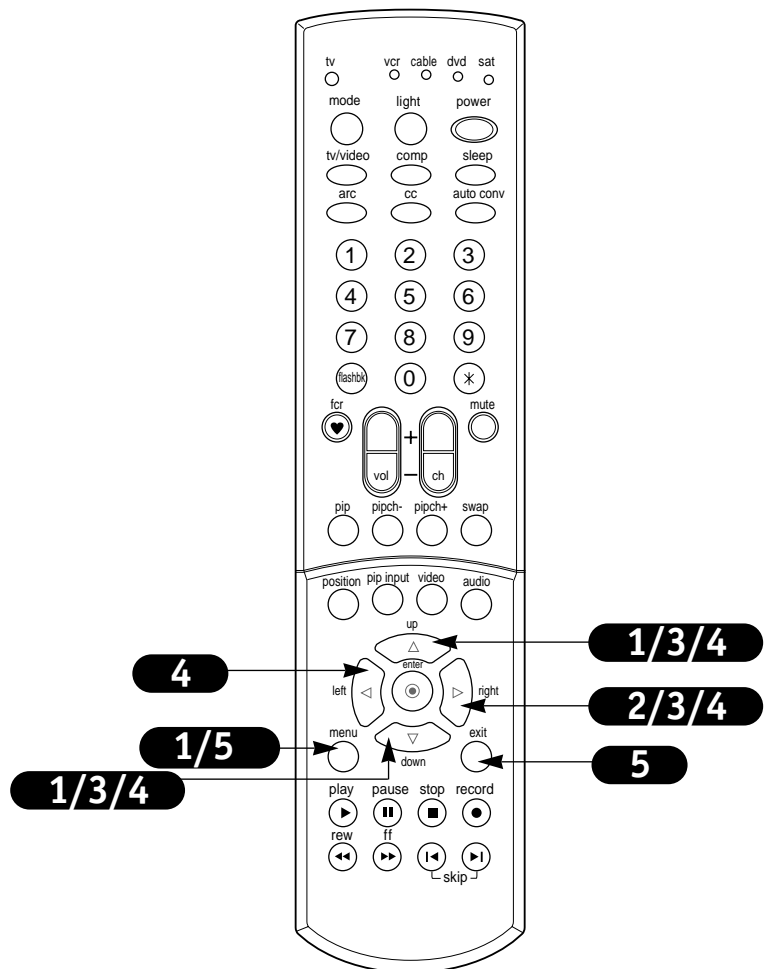

VIDEO Menu

Color Temperature

Specify the picture color status.

- 1 Press the MENU button on the remote control, then use the UP/DOWN arrow button to select the Video menu.
- 2 Press the RIGHT arrow button to access the Video menu.
- 3 Use the UP/DOWN arrow button to select Color temperature, and then press the RIGHT arrow button.
- 4 Use the UP/DOWN arrow button to select Warm, Medium, or Cool.
- 5 Press EXIT button to save and return to TV viewing or press MENU button to save and return to the previous menu.



Scan Mode

Use this function to select output format.

- 1 Press the MENU button on the remote control, then use the UP/DOWN arrow button to select the Video menu.
- 2 Press the RIGHT arrow button to access the Video menu.
- 3 Use the UP/DOWN arrow button to select mode, and then press the Right arrow button.
- 4 Use the UP/DOWN arrow button to select 1080i or 540p.
 - Select 1080i when watching normal TV, movies etc.
 - Select 540p when viewing a more stationary image, a video game for example
- 5 Press EXIT button to save and return to TV viewing or press MENU button to save and return to the previous menu.

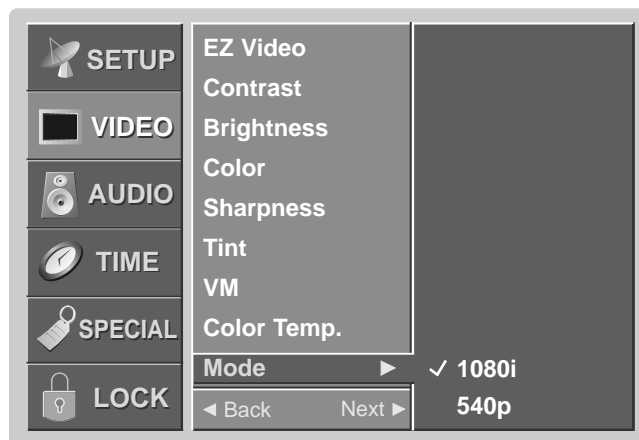

AUDIO Menu

MTS

Lets you choose the default audio mode for conventional analog programs. When you hear a program broadcast in mono, you will hear only monaural sound, even though Stereo mode is set. When Second Audio Program (SAP) mode is set, the program's second audio program, usually the program's dialog in another language, (if provided), is broadcast in mono.

- 1 Press the MENU button on the remote control, then use the UP/DOWN arrow button to select the Audio menu.
- 2 Press the RIGHT arrow button to access the Audio menu.
- 3 Use the UP/DOWN arrow button to select MTS, then press the RIGHT arrow button.
- 4 Use the UP/DOWN arrow button to select Mono, Stereo, or SAP.
- 5 Press EXIT button to save and return to TV viewing or press MENU button to save and return to the previous menu.

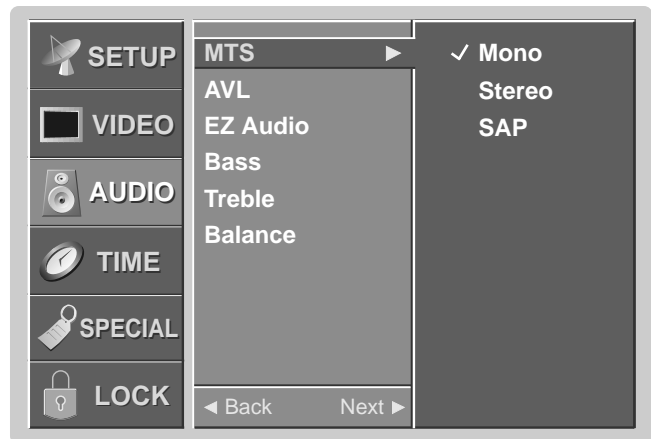

AVL (Auto Volume Leveler)

AVL maintains an equal volume level; even if you change channels.

- 1 Press the MENU button on the remote control, then use the UP/DOWN arrow button to select the Audio menu.
- 2 Press the RIGHT arrow button to access the Audio menu.
- 3 Use the UP/DOWN arrow button to select AVL, then press the RIGHT arrow button.
- 4 Use the UP/DOWN arrow button to select On or Off.
- 5 Press EXIT button to save and return to TV viewing or press MENU button to save and return to the previous menu.

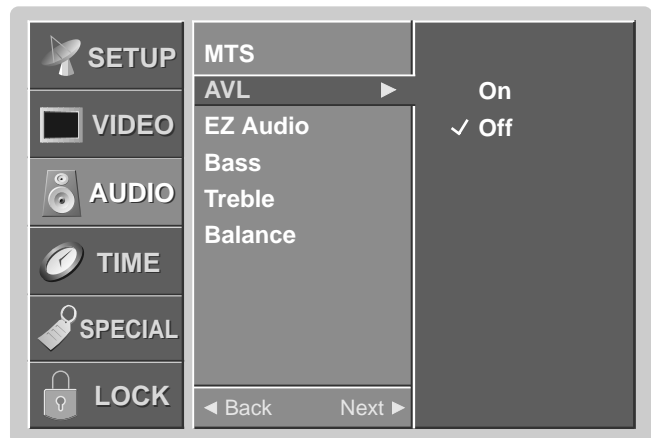

AUDIO Menu

EZ Audio

This function lets you enjoy the best sound without any special adjustment because the TV automatically selects the appropriate sound option based on the program content. Audio options ( Virtual, flat, music, sports, movie and off) are preset for good sound quality at the factory and cannot be changed. When adjusting audio options (bass, treble and balance) manually, EZ audio automatically changes to 'Off'.

1 Use the AUDIO button to select EZ Audio option.

Each press of the AUDIO button changes the EZ audio option;  Virtual, Flat, Music, Sports, Movie and Off.

2 Press EXIT to save and return to TV viewing.



You can also select EZ Audio in the Audio menu.



Manufactured under license from Dolby Laboratories. "Dolby" and the double-D symbol are trademarks of Dolby Laboratories.

 Virtual let's you experience panoramic sound effects.

Manual Sound Control (Off option)

Adjust the sound to suit your taste and room situations.

1 Press the MENU button on the remote control, then use the UP/DOWN arrow button to select the Audio menu.

2 Press the RIGHT arrow button to access the Audio menu.

3 Use the UP/DOWN arrow button to select one of the following options: Bass, Treble and Balance. Then press the Right arrow button.

- **Bass:** Increases or decreases the lower frequency sounds of the TV speakers.
- **Treble:** Increases or decreases the higher frequency sounds of the TV speakers. Increases in treble, for example, make voice or string sounds stand out.
- **Balance:** Lets you adjust the left to right balance of the TV speakers.

4 Use the LEFT/RIGHT arrow button to adjust the option to your preference. Use the UP/DOWN arrows to select another option.

5 Press EXIT button to save and return to TV viewing or press MENU button to save and return to the previous menu.

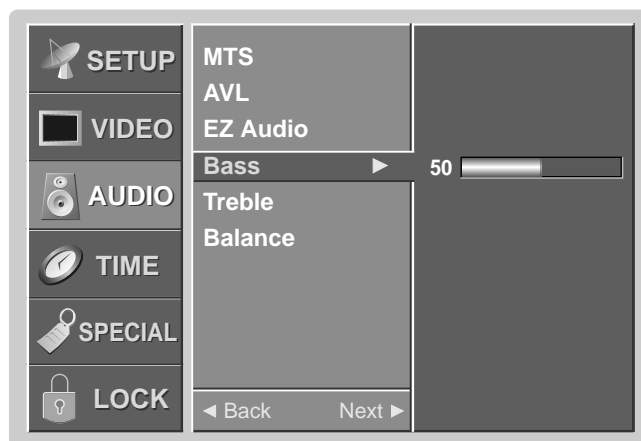

Auto Clock Setup

Sets the time automatically through the PBS broadcast signal.

The PBS channel signal includes information for the correct time.

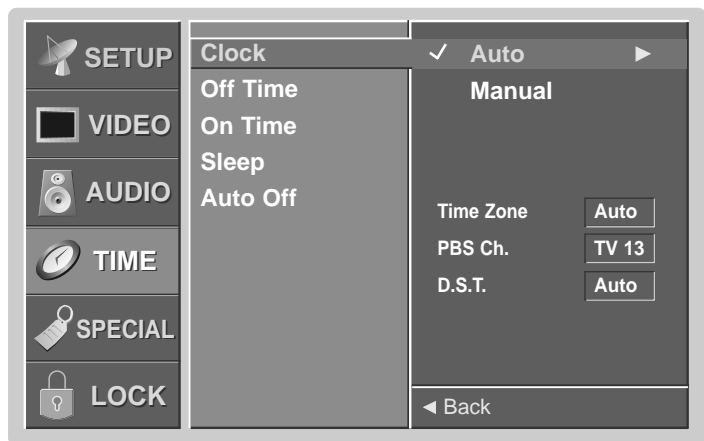

1 Press the MENU button on the remote control, then use the UP/DOWN arrow button to select the Time menu.

2 Press the RIGHT arrow button to go to the Time menu.

3 Use the UP/DOWN arrow button to choose Clock, then press the RIGHT arrow button to activate the clock option.

4 Use the UP/DOWN arrow button to select Auto, then press the RIGHT arrow button.

5 Press the  button repeatedly to select Clock Auto submenu options: Time Zone, PBS channel, and D.S.T. (Daylight Savings Time), then use the UP/DOWN arrow button to make an Auto submenu selection.

- Time Zone - Select the time zone for your viewing area. Your options are: Auto, E.S.T. (Eastern Standard Time), C.S.T. (Central Standard Time), M.S.T. (Mountain Standard Time), P.S.T. (Pacific Standard Time), Alaska, Hawaii.
- Use the UP/DOWN arrow button to set the PBS channel.
- D.S.T. (Daylight Savings Time)- Lets you set D.S.T. Auto, On or Off, depending on whether or not your viewing area observes Daylight Savings Time.

6 Press EXIT button to save and return to TV viewing or press the MENU button to save and return to the previous menu.

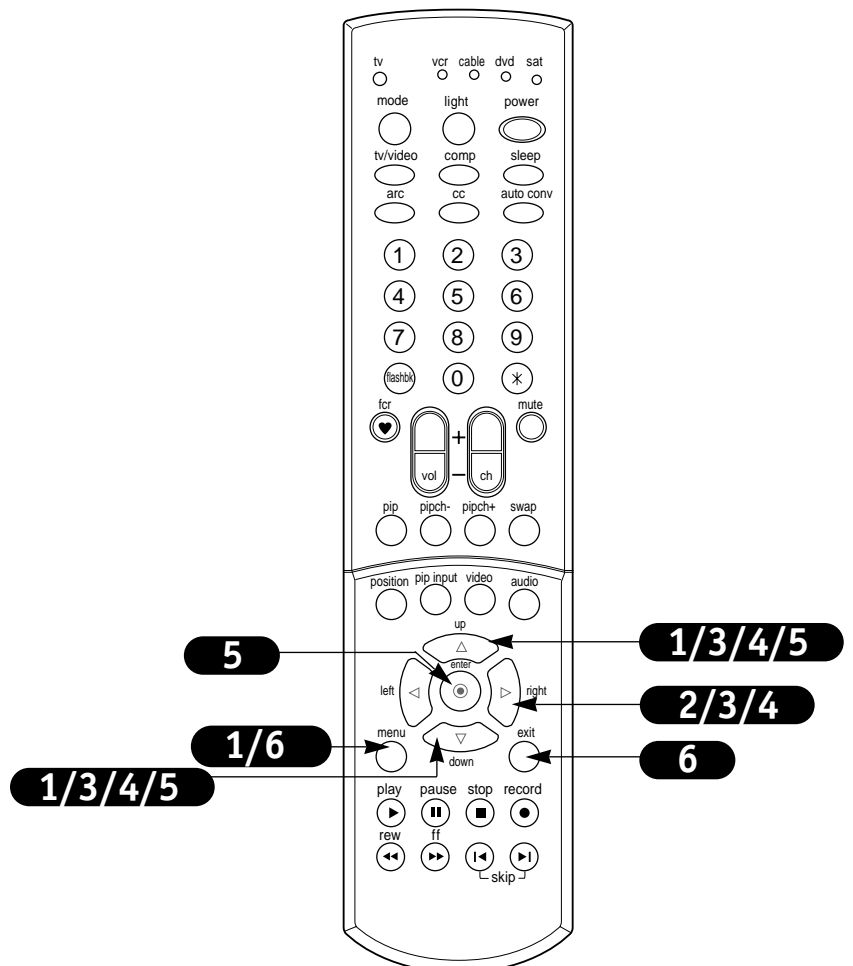

Manual Clock Setup

If current time setting is erased by a power failure or if TV is unplugged, reset the clock.

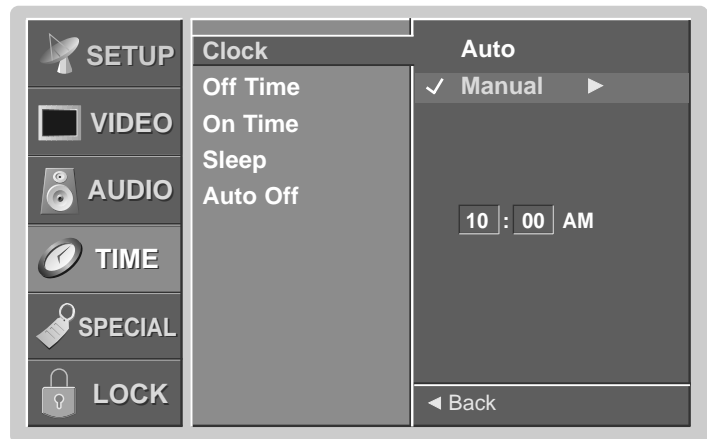

1 Press the MENU button on the remote control, then use the UP/DOWN arrow button to select the Time menu.

2 Press the RIGHT arrow button to activate the Time menu.

3 Use the UP/DOWN arrow button to choose Clock, then press the RIGHT arrow button to activate Clock option.

4 Use the UP/DOWN arrow button to select manual then press the RIGHT arrow button.

5 Use the \odot button to select either the hour or minutes option, once selected, use the UP/DOWN arrow button to set the hours or minutes.

6 Press EXIT button to save and return to TV viewing or press the MENU button to save and return to the previous menu.

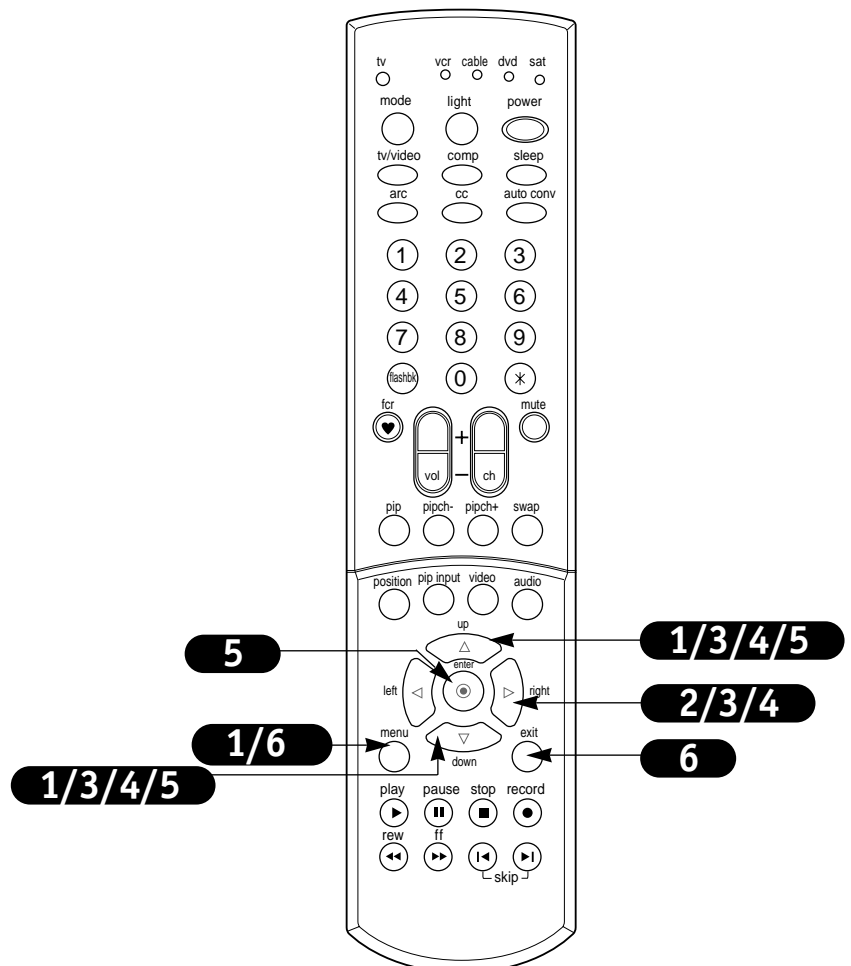

TV Turn Off Time Setup

Lets you set an automatic daily turn off time for your TV.

Off Timer function overrides On Time function if they are both set to the same time.

You must set the current time before using on/off time function.

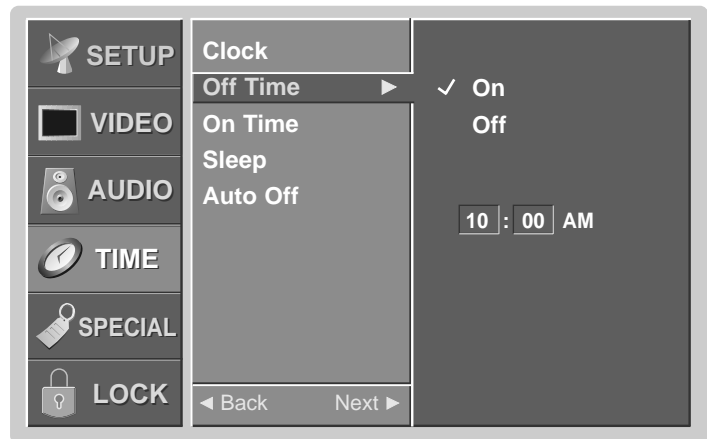

- 1** Press the MENU button on the remote control, then use the UP/DOWN arrow button to select the Time menu.
- 2** Press the RIGHT arrow button to activate the Time menu.
- 3** Use the UP/DOWN arrow button to choose Off Time then press the RIGHT arrow button to activate Off Time option.
- 4** Use the UP/DOWN arrow button to choose On, then press the RIGHT arrow button.
- 5** Use the \odot button to select the hour or minutes options, then use the UP/DOWN arrow button to set the hours or minutes.
- 6** Press EXIT button to save and return to TV viewing, or press the MENU button to save and return to the previous menu.



To cancel Off time function, use the UP/DOWN arrow button to select Off in step 4.

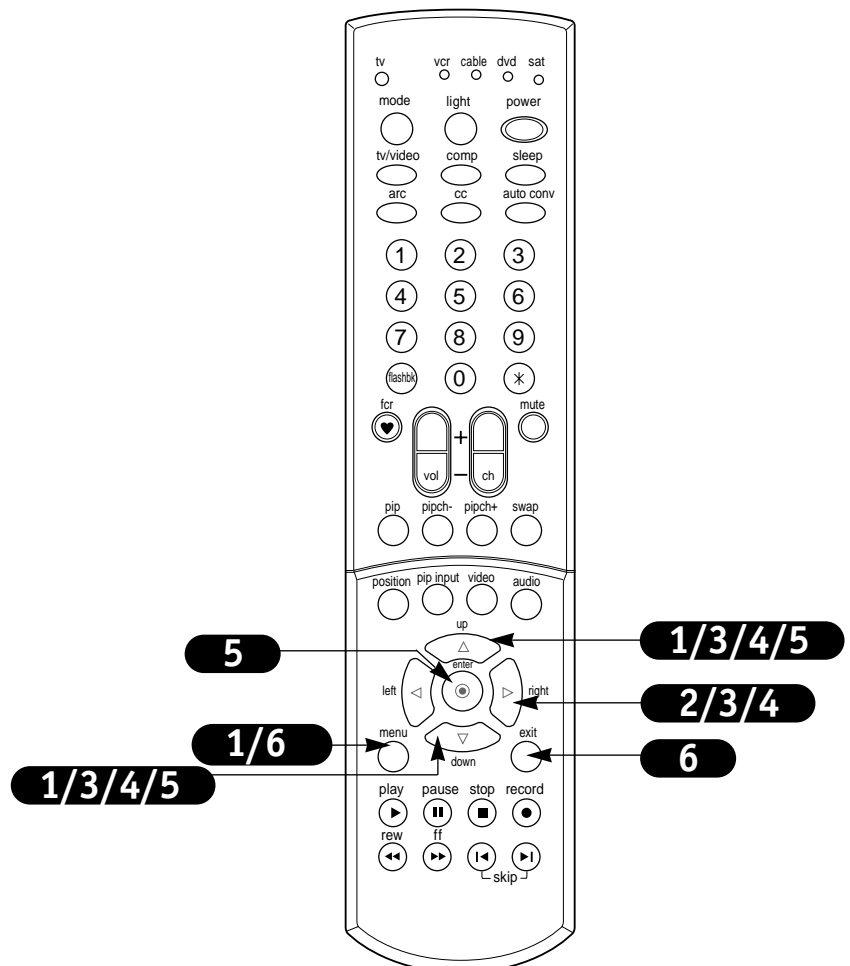

TV Turn On Time Setup

Lets you set an automatic daily turn on time for your TV.

Off timer function overrides on timer function if they are both set to the same time.

Unless a button is pressed within two hours after the TV is turned on by the On Time function, the TV will automatically turn off.

TV must be in standby mode for the On Timer to work.

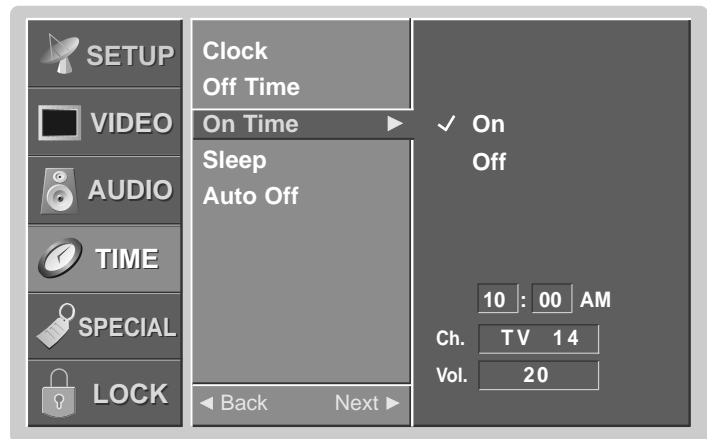

- 1** Press the MENU button on the remote control, then use the UP/DOWN arrow button to select the Time menu.
- 2** Press the RIGHT arrow button to activate the Time menu.
- 3** Use the UP/DOWN arrow button to choose On Time then press the RIGHT arrow button to activate On Time option.
- 4** Use the UP/DOWN arrows to choose On, then press the RIGHT arrow button.
- 5** Use the  button to select the On Time menu options. Your options are: Time, channel, and Volume, then use the UP/DOWN arrow button to set either the Time, Channel, and Volume.
- 6** Press EXIT button to save and return to TV viewing, or press the MENU button to save and return to the previous menu.



To cancel On time function, : Use the UP/DOWN arrow button to select Off in step 4.

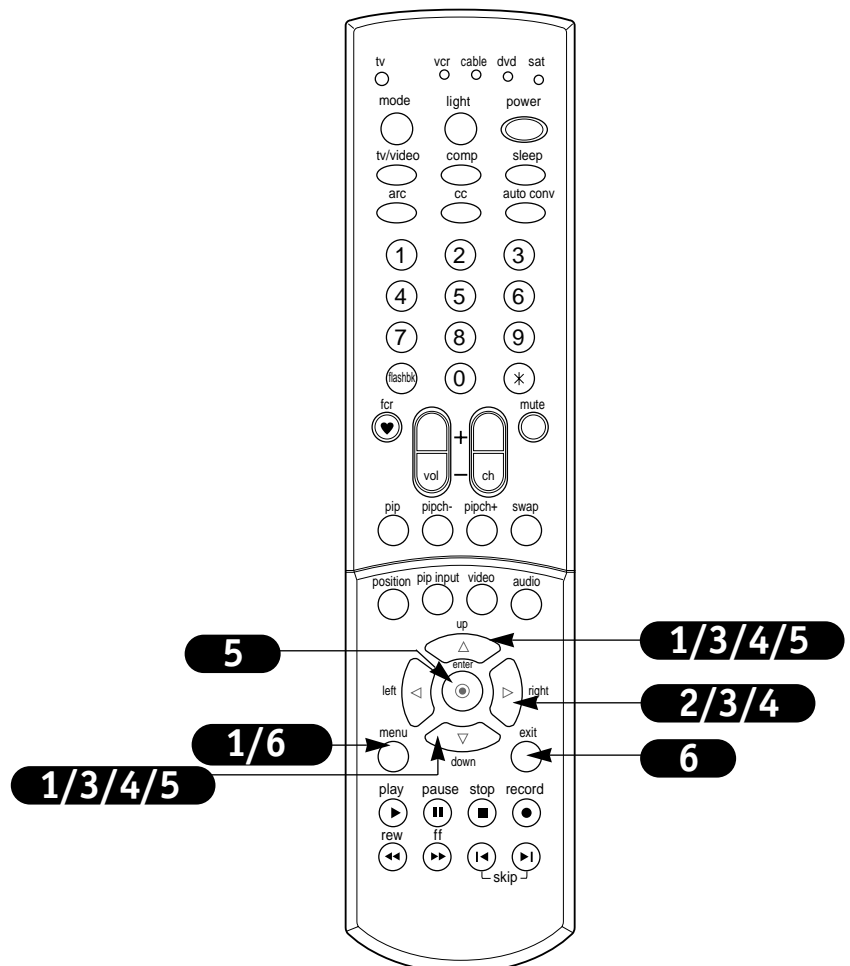

Sleep Timer Setup





Lets you select the amount of time before your TV automatically turns itself off.



- 1** Press the SLEEP button on the remote control repeatedly to select the number of minutes.

First the Off option will appear on the screen, followed in sequence 10, 20, 30, 60, 90, 120, 180, and 240. The timer begins to count down from the number of minutes selected.

- 2** Press EXIT button to save and return to TV viewing

-  When the sleep time you want is displayed on the screen, don't press the sleep button again.
-  To check the remaining sleep time, press the sleep button once.
-  To change sleep time setting, press the sleep button repeatedly to select time setting you want.
-  If you turn the TV off after setting the sleep timer, the setting will be erased.
-  You can also select Sleep in the Time menu.

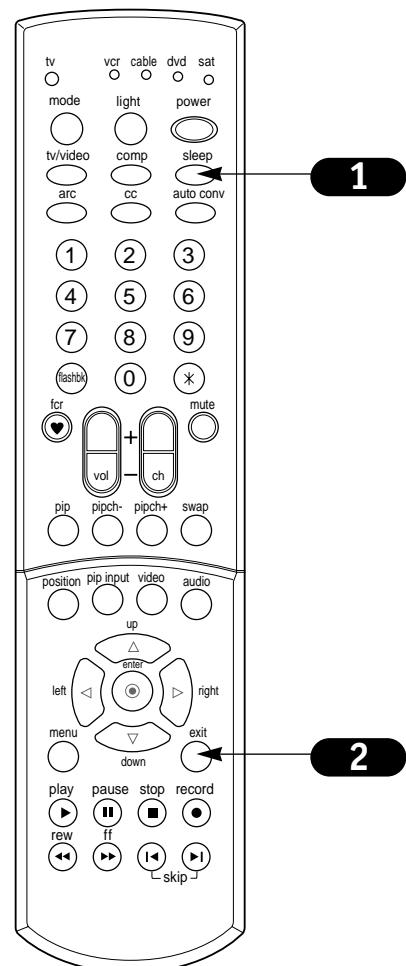

Auto Off

If there is no input signal, the TV switches to standby mode automatically after 10 minutes.

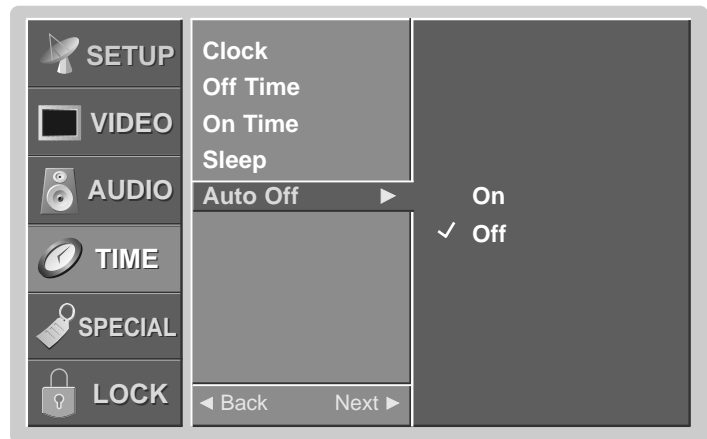

- 1** Press the MENU button on the remote control, then use the UP/DOWN arrow button to select the Time menu.
- 2** Press the RIGHT arrow button to activate the Time menu.
- 3** Use the UP/DOWN arrow button to choose Auto off then press the RIGHT arrow button to activate Auto off.
- 4** Use the UP/DOWN arrows to choose On or Off.
- 5** Press EXIT button to save and return to TV viewing, or press the MENU button to save and return to the previous menu.

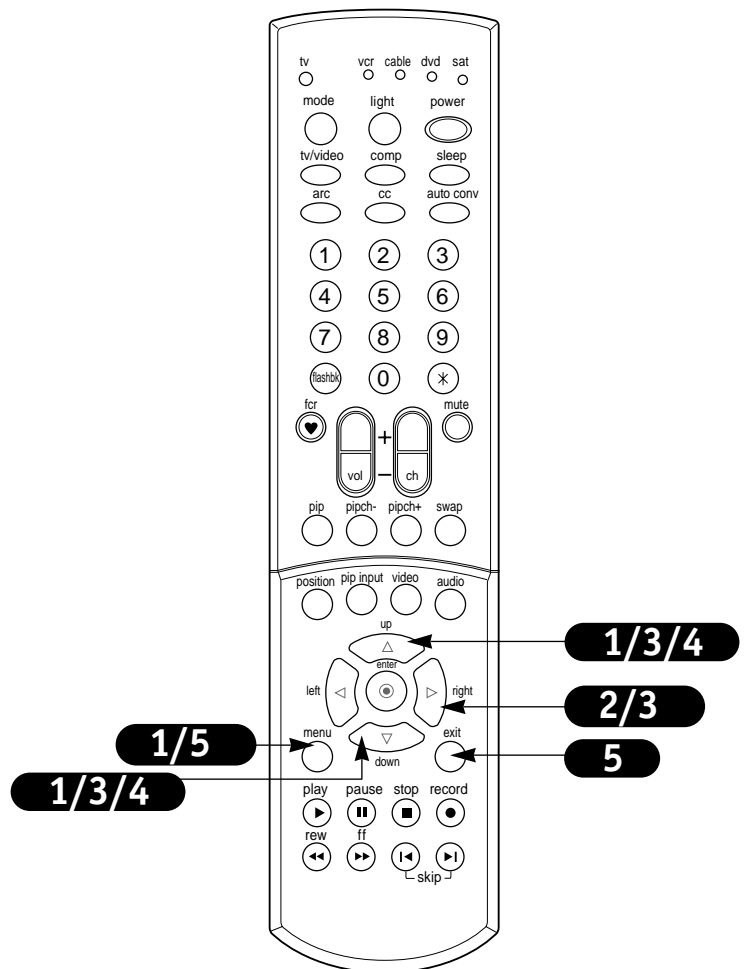

On-Screen Menus Language

Select your preferred language for the menus: English, Español, or Français.



- 1** Press the MENU button on the remote control, then use the UP/DOWN arrow button to select the Special menu.
- 2** Press the RIGHT arrow button to go to the Special menu.
- 3** Use the UP/DOWN arrows to choose the Language option.
- 4** Press the RIGHT arrow button to go to the Language selection menu. Use the UP/DOWN arrow button to select the language you wish the onscreen menus to appear in.
- 5** Press EXIT button to save and return to TV viewing or press the MENU button to save and return to the previous menu.

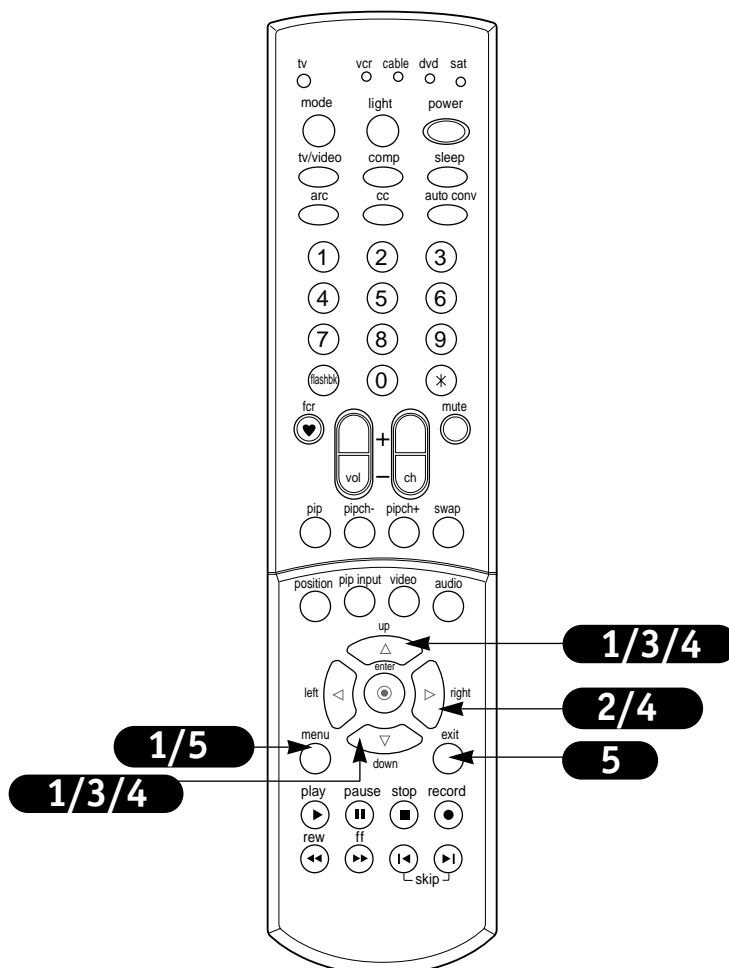

Main Picture Source Selection

Note: This TV is equipped with Picture-in-Picture. Select a viewing source for the main picture on this page and select a viewing source for the PIP picture inset on the following page.

Changes the picture source for the main screen so you can watch your off-air TV, cable TV, VCR, DVD, or any other devices that are connected to your TV.

You can also change the Main picture source with the Source buttons on the remote control: TV/Video and Component.

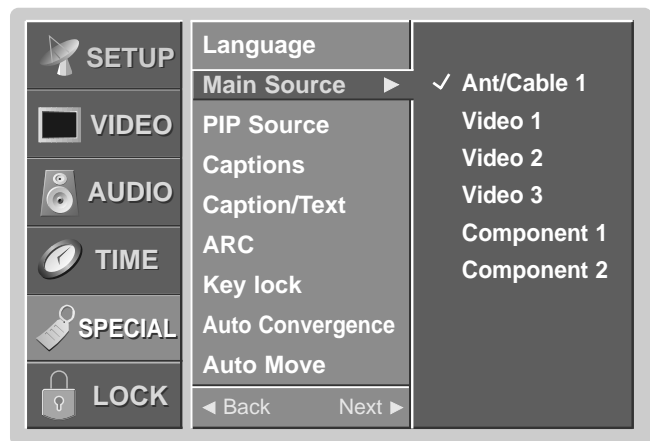

- 1** Press the MENU button on the remote control, then use the UP/DOWN arrow button to select the Special menu.
- 2** Press the RIGHT arrow button to access the Special menu.
- 3** Use the UP/DOWN arrows to select the Main Source option.
- 4** Press the RIGHT arrow to access the Main Source menu, then use the UP/DOWN arrow button to select the source. Your Main picture source options are : Ant/Cable 1 (Ant/Cable 2), Video 1, Video 2, Video 3, Component 1, and Component 2.
- 5** Press EXIT button to save and return to TV viewing or press the MENU button to save and return to the previous Menu.

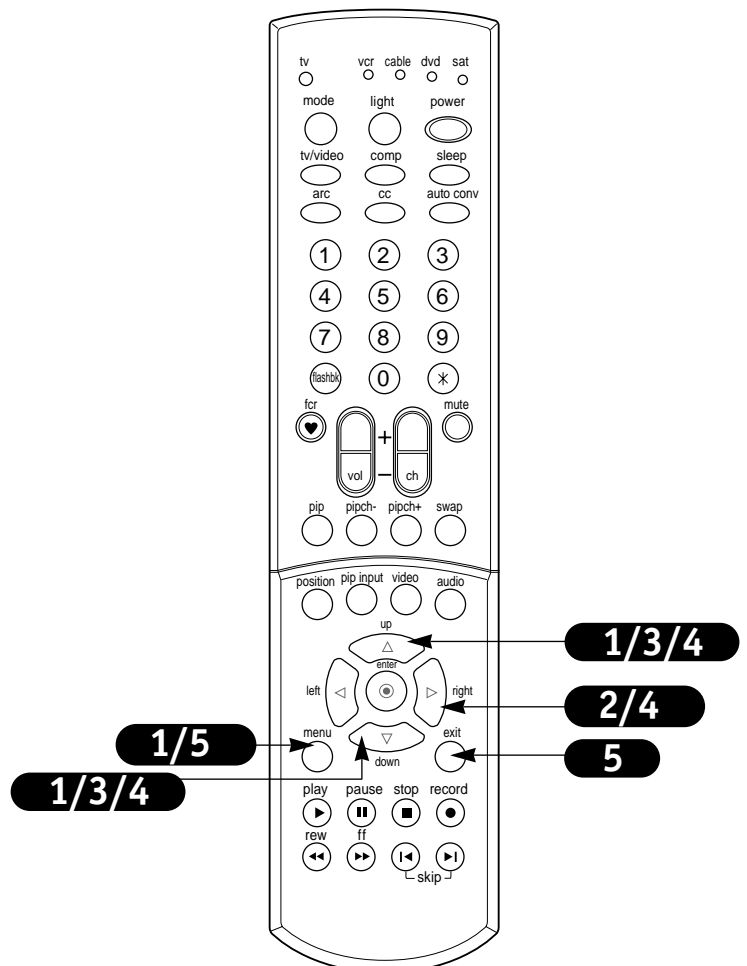

PIP (Picture-In-Picture) Source

PIP lets you view 2 different inputs (sources) on your monitor screen at the same time. One source will be large, and the other source will show a smaller inset image.

PIP is not available if you set lock "On" in Lock menu.

Watching PIP

Press the PIP button to show the sub picture.
Each press of PIP changes the PIP options as shown below.

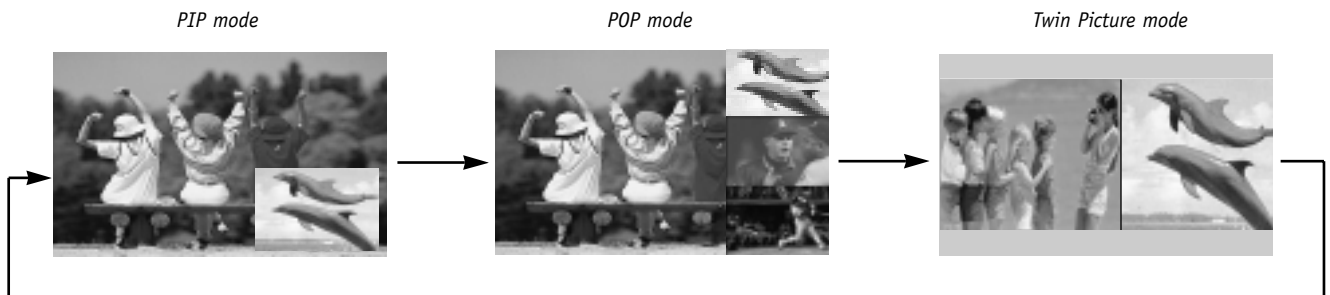

PIP Source Selection

Changes the picture source for the Picture-In-Picture screen so you can watch your off-air TV, cable TV, VCR, or any other devices that are connected to your TV.

Using the menu

- 1** Press the MENU button on the remote control, then use the UP/DOWN arrow button to select the Special menu.
- 2** Press the RIGHT arrow button to access the Special menu.
- 3** Use the UP/DOWN arrows to select the PIP Source option.
- 4** Press the RIGHT arrow to access the PIP source menu, then use the UP/DOWN arrow button to select the source. Your choices are: TV (Ant/Cable 1, Ant/Cable 2), Video 1, Video 2, Video 3.
- 5** Press EXIT button to save and return to TV viewing or press the MENU button to save and return to the previous Menu.

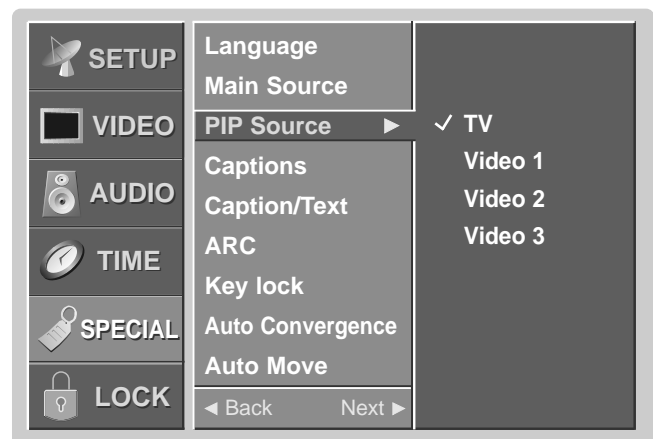

Do not display a fixed image on the screen for long periods of time.



Not all sources are available for PIP.

Using the PIP INPUT button

- 1** Use the PIP INPUT button to select the input source for the sub picture. Each time you press PIP INPUT button, you toggle between TV, VIDEO 1, VIDEO 2, and VIDEO 3.

PIP (Picture-In-Picture) Options

Selecting PIP Channels

- 1 Press the PIP button in the PIP mode.
- 2 Select the TV option on the PIP Source menu or with the PIP INPUT button. Use the PIPCH-/PIPCH+ button to select a channel for the sub picture. Changing programs for the sub picture is only possible when the 'TV' option is selected as PIP source (NTSC RF signal).

Swapping Screen

Press the SWAP button.
Each time you press the SWAP button, you switch the Main and PIP pictures.

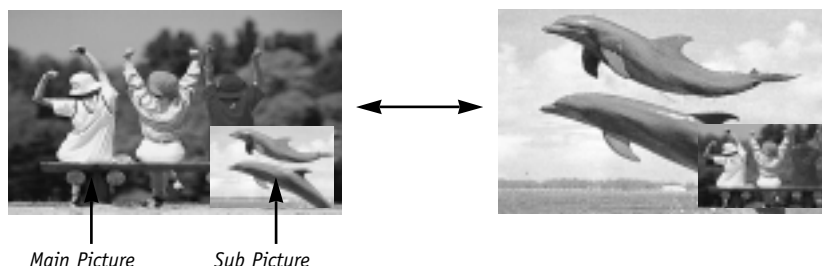

Moving the Sub Picture

Press the POSITION button in the PIP mode.
Each press of the POSITION button will move the sub picture to a different position on the screen in a clock-wise direction.

POP (Picture-Out-of-Picture) Source

This is the function to search one-by-one the pictures of all the programmed channels on the 3 PIP screen display while the main screen remains the current channel.

POP is not available if you set lock "On" in Lock menu.

- 1 Press PIP on the remote control with the PIP image on the screen to activate POP (Picture -out-of-Picture) mode. The pictures of all the programmed channels are searched with the 3 PIP screen, as shown right.

- By pressing SWAP, you can enlarge the channel being searched on the PIP screen to view it on the Main screen.

- 2 Press the EXIT button to exit POP mode.



Caption/Text is not available in POP mode.



Run EZ Scan channel search before using POP mode.



Twin Picture

Twin Picture splits the screen into 2, allowing 2 picture sources to be shown on the TV screen at the same time. Each source is given half the screen.

Twin picture mode is not available if you set lock "On" in Lock menu.

Watching Twin Picture

1

Press the PIP button on the remote control in POP mode to activate twin picture mode. Select the TV option on the PIP Source menu or with the PIP INPUT button. Use the PIPCH-/PIPCH+ button to select the desired channel for the sub picture. Changing programs for the sub picture is only possible when the 'TV' option is selected as PIP source (NTSC RF signal).

2

Press the EXIT button to exit twin picture mode.

Swapping Screen

Press the Swap button.
Each time you press SWAP, you switch the PIP and Main screen channels.

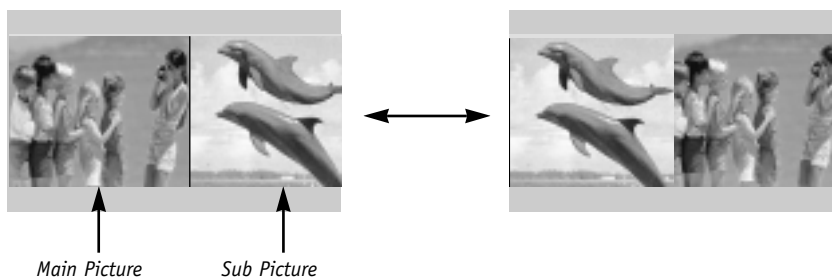

Selecting an Input Signal Source for Sub Picture

Use the PIP INPUT button to select the input source for the sub picture. Each time you press PIP INPUT, you toggle between TV, VIDEO 1, VIDEO 2, and VIDEO 3.

Captions



1 Press the CC button to select captions.

Each press of the CC button change the caption option; On, EZ Mute and Off. Captions Setup is complete. EZ Mute shows the selected captions option (if available on program) when the TV sound is muted.

2 Press EXIT to save and return to TV viewing.



You can also select Captions in the Special menu.

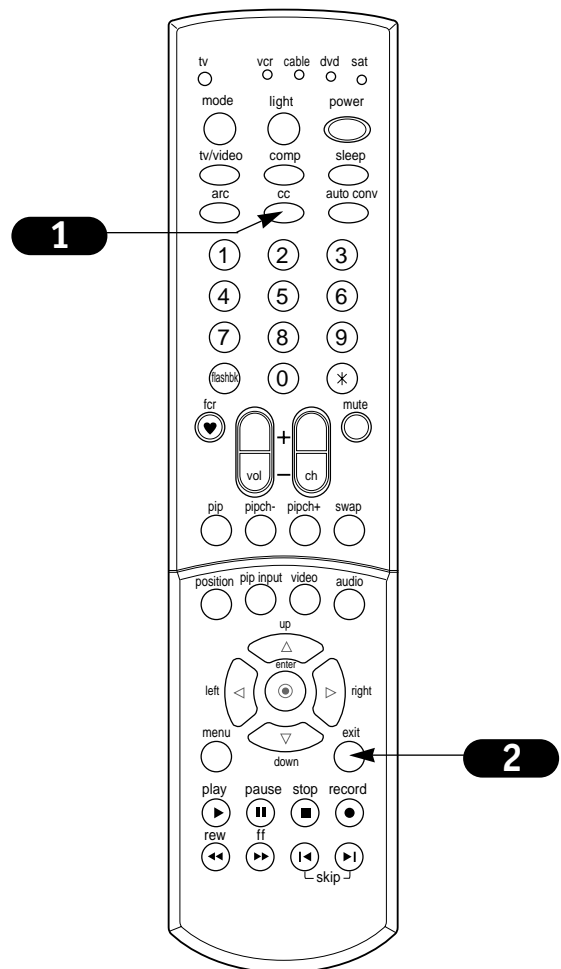

Captions/Text

Select a closed caption mode for displaying captioning information when provided on the program.

Closed Caption (CC) displays information at any position on the screen usually the program's dialog.

Text displays information, usually at the bottom position and is used for a data service, generally not program related.

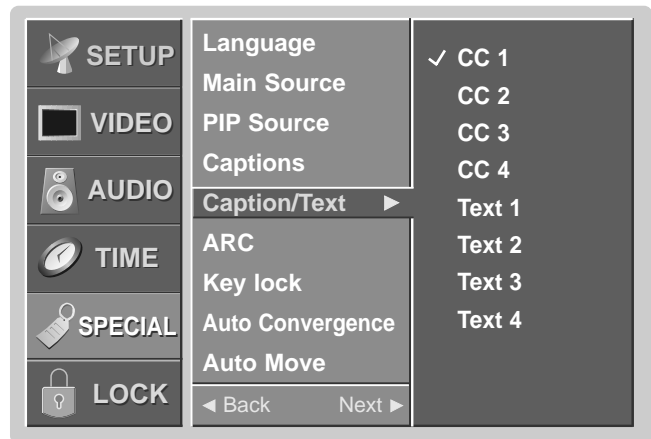

- 1** Press the MENU button on the remote control, then use the UP/DOWN arrow button to select the Special menu.
- 2** Press the RIGHT arrow button to activate the Special menu.
- 3** Use the UP/DOWN arrow button to choose Caption/Text, then press the Right arrow button.
- 4** Use the UP/DOWN arrow button to make your caption selection. Your choices are: CC 1, CC 2, CC 3, CC 4, Text 1, Text 2, Text 3 and Text 4.
- 5** Press EXIT button to save and return to TV viewing or press the MENU button to save and return to the previous menu.



This TV is programmed to remember the caption/text mode it was last set to, when you turn the POWER off.

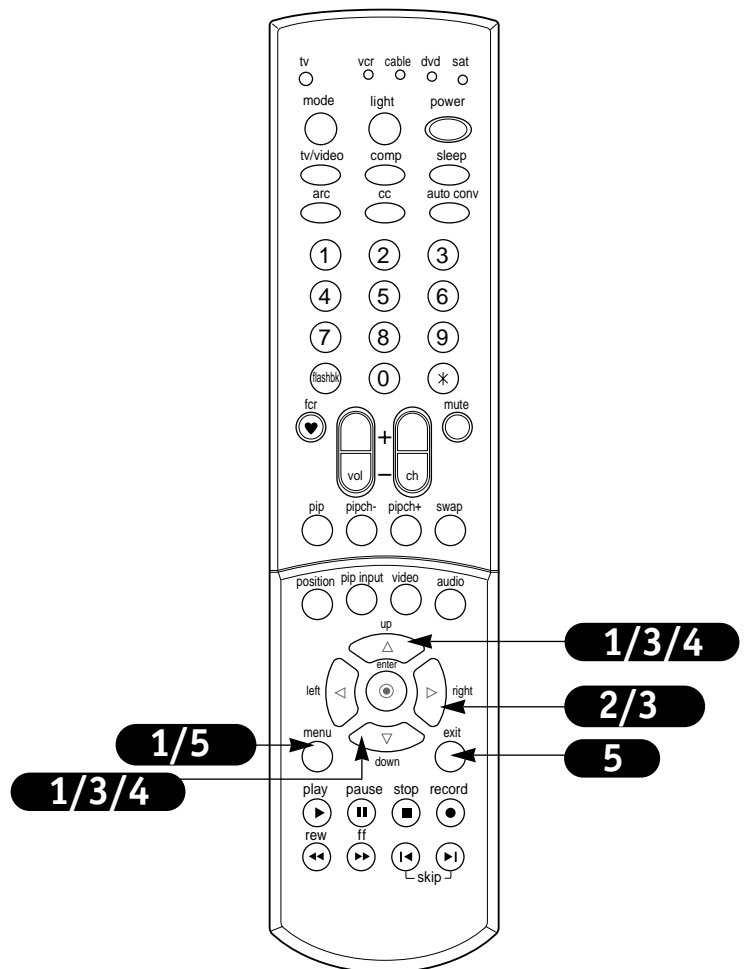

Aspect Ratio Control

Lets you choose the way that an analog picture with a 4:3 aspect ratio is displayed on your TV with a 16:9 ratio. When you receive an analog picture with a 4:3 aspect ratio on your 16:9 TV, you need to specify how the picture is to be displayed according to your preference.

1

Use the ARC button to select the desired picture format.

Each press of the ARC button changes the picture format. Your options are: 4:3, 16:9, Panorama, Zoom1, and Zoom2.

- 4:3 - Choose when you want to view a picture with an original 4:3 aspect ratio, with black bars appearing at both the left and right sides.
- 16:9 (Wide) - Choose when you want to adjust the picture horizontally, in a linear proportion to fill the entire screen. (Useful for viewing 4:3 formatted DVDs.)
- Panorama - Choose when you want to adjust the picture in a non-linear proportion, that is, more enlarged at both sides, to create a spectacular view.
- Zoom1 - Choose when you want to view the picture without any alteration. However, the top and bottom portions of the picture will be cropped.
- Zoom2 - Choose when you want the picture to be altered, both horizontally extended and vertically cropped. The picture taking a halfway trade off between alteration and screen coverage.

2

Press EXIT to save and return to TV viewing.



You can also select ARC (Aspect Ratio Control) in the Special Menu.

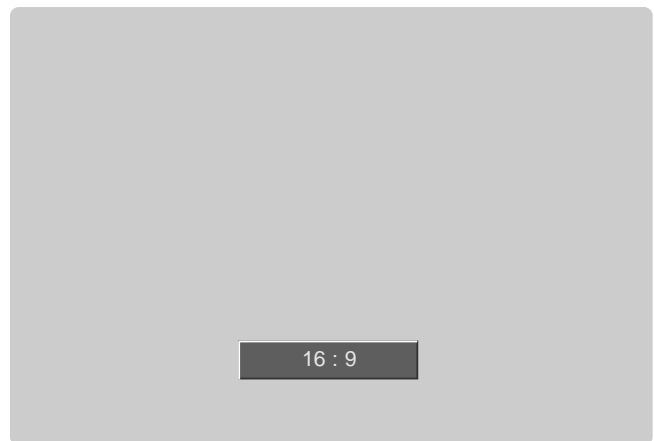

1

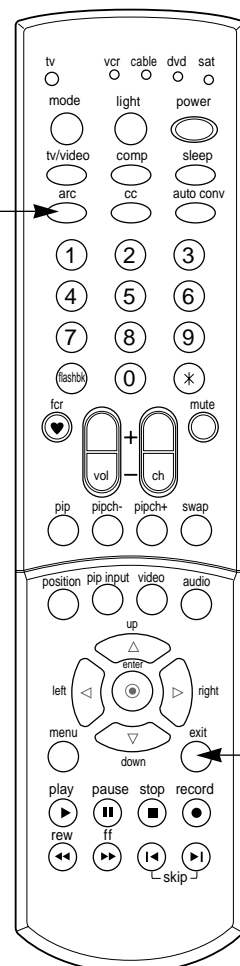

2

Key Lock

The TV can be set up so that it can only be operated with the remote control.

This feature can be used to prevent unauthorized viewing.

This TV is programmed to remember which option it was last set to even if you turn the TV off.



- 1** Press the MENU button on the remote control, then use the UP/DOWN arrow button to select the Special menu.
- 2** Press the RIGHT arrow button to activate the Special menu.
- 3** Use the UP/DOWN arrow button to choose Key lock, then press the RIGHT arrow button.
- 4** Use the UP/DOWN arrow button to select On or Off.
- 5** Press EXIT button to save and return to TV viewing or press the MENU button to save and return to the previous menu.



With the KEY LOCK ON, the display 'KEY LOCK' appears on the screen if any button on the front panel is pressed while viewing the TV.



This TV is programmed to remember which option it was last set to even if you turn the TV off.

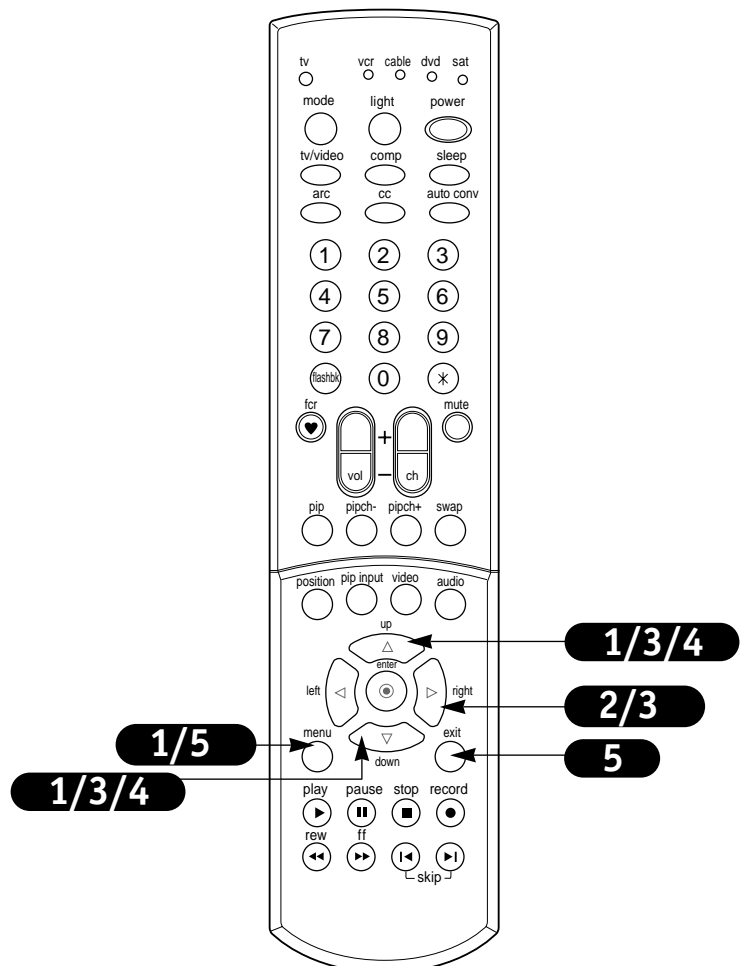

Auto Convergence

When the TV is first installed or relocated, the picture may be unstable and have three color ghosts (red, green, blue). This problem can be solved with Auto Convergence.

This function can adjust the picture color convergence automatically if the TV is receiving a stable signal.

Wait 20 minutes after turning on the TV before using Auto Convergence.

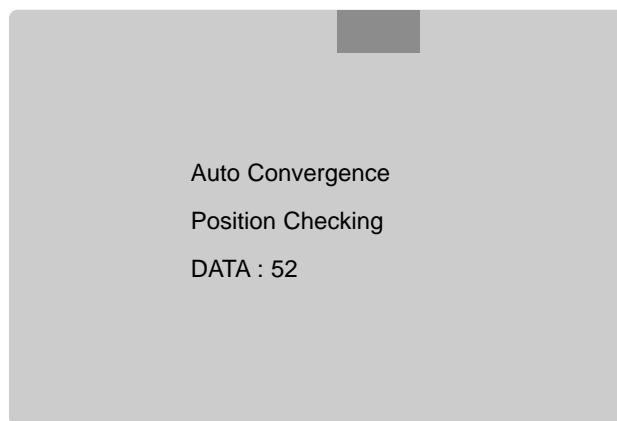

1

Press the AUTO CONV button to start auto convergence.

- The color convergence order will be: blue, green, then red.
- The auto convergence function takes about 30 seconds.



Darken the room before adjusting color convergence.



You can also select Auto convergence in the Special menu.

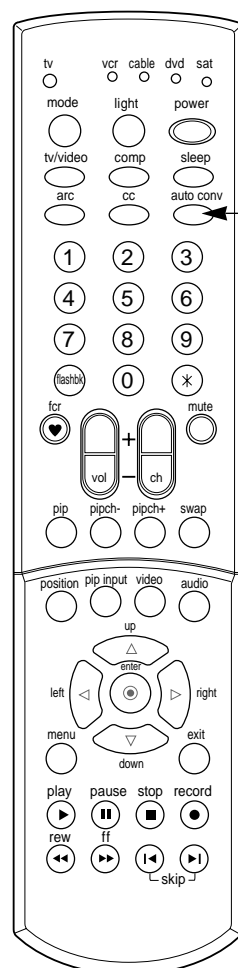

1

Auto Move

Auto move may help prevent a ghost image.

The picture will move to right and left about 5mm every 2 hours in 4:3 aspect ratio.

The picture will move to up and down about 5mm every 2 hours in twin picture mode.

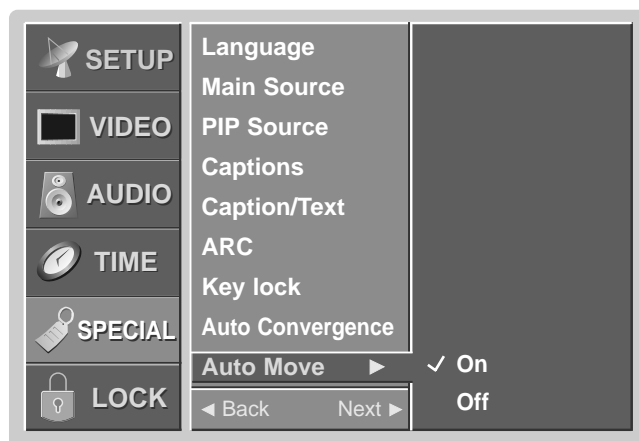

- 1** Press the MENU button on the remote control, then use the UP/DOWN arrow button to select the Special menu.
- 2** Press the RIGHT arrow button to activate the Special menu.
- 3** Use the UP/DOWN arrow button to choose Auto Move, then press the RIGHT arrow button.
- 4** Use the UP/DOWN arrow button to select On or Off.
- 5** Press EXIT button to save and return to TV viewing or press the MENU button to save and return to the previous menu.

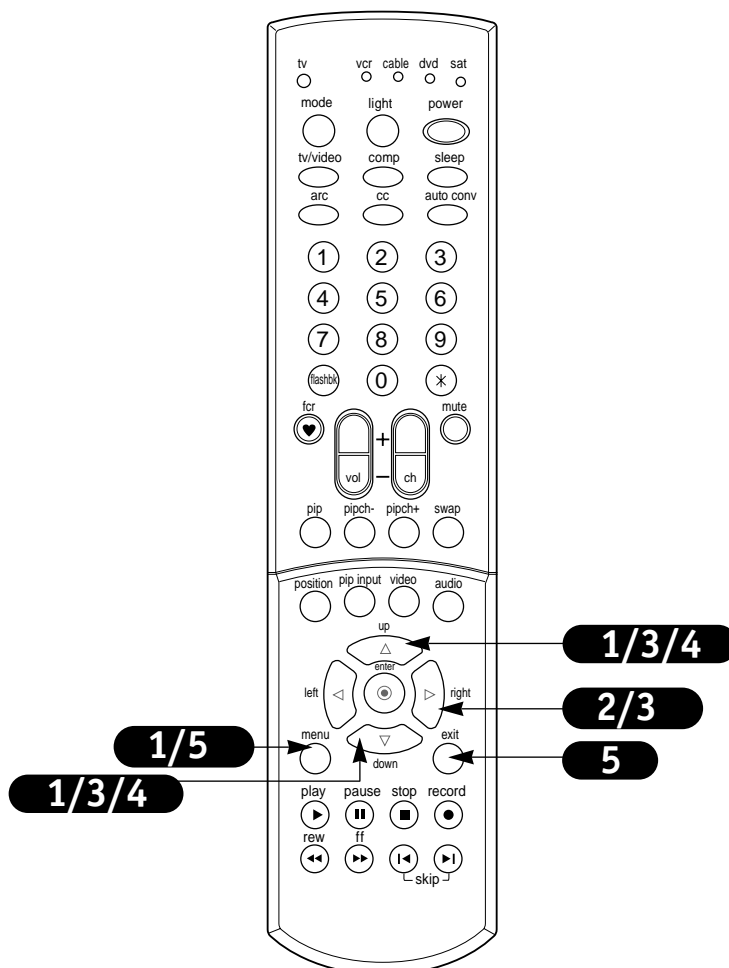

Parental Lock Setup

Lets you set up blocking schemes to block specific channels, ratings and viewing sources.

A password is required to gain access to this menu if the Lock System is activated.

PIP/POP/Twin picture functions are not available if you set Lock "On" in Lock menu.

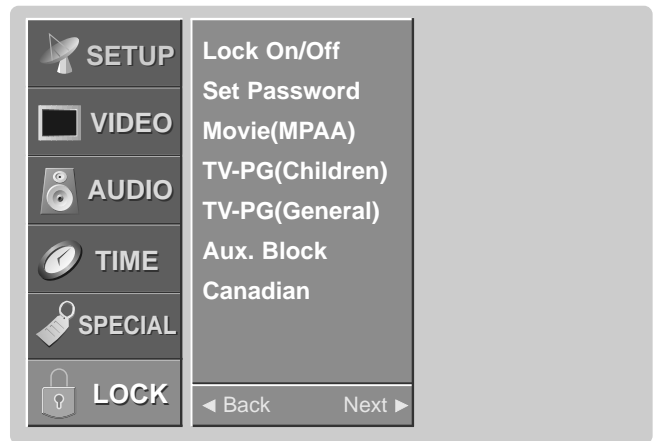

1 Press the MENU button on the remote control, then use the UP/DOWN arrow button to select the Lock Menu.

2 Press the RIGHT arrow button to activate the Lock Menu.

3 See the next page for more details on your blocking options.

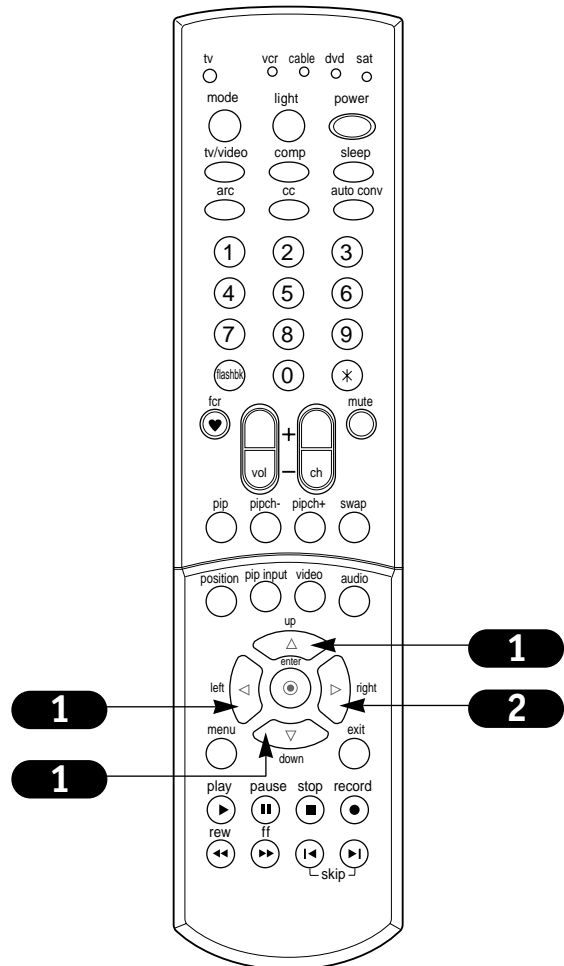

Parental Lock Setup Continued

4

Use the UP/DOWN arrows to choose from the following LOCK Menu options. Once the options are selected, change the settings to your preferences.

- **Lock On/Off:** Activates or disables the blocking scheme you set up previously.
- **Set Password:** Change the password by inputting a new password twice.
- **Movie (MPPA):** Blocks movies according to the movie ratings limit, so children cannot view certain movies. You can set the ratings limit by blocking out all the movies with the ratings above a specified level. Keep in mind that the movie ratings limit only applies to movie shown on TV, not TV programs, such as soap operas.
- **TV-PG (Children):** Keeps children from watching certain TV programs among only the programs intended for children, according to the ratings limit. This rating does not apply to other TV programs. Unless you block certain TV programs intended for mature audiences in the TV Rating - General menu, your children may view those programs.
- **TV-PG (General):** Blocks certain TV programs that you and your family do not want to view, based on the ratings.
- **Aux. Block:** Enables you to select a source for blocking among the source devices you have hooked up.
- **Canadian:** Selects Canadian English/French language rating system.

5

Press EXIT button to save and return to TV viewing or press the MENU button to save and return to the previous menu.

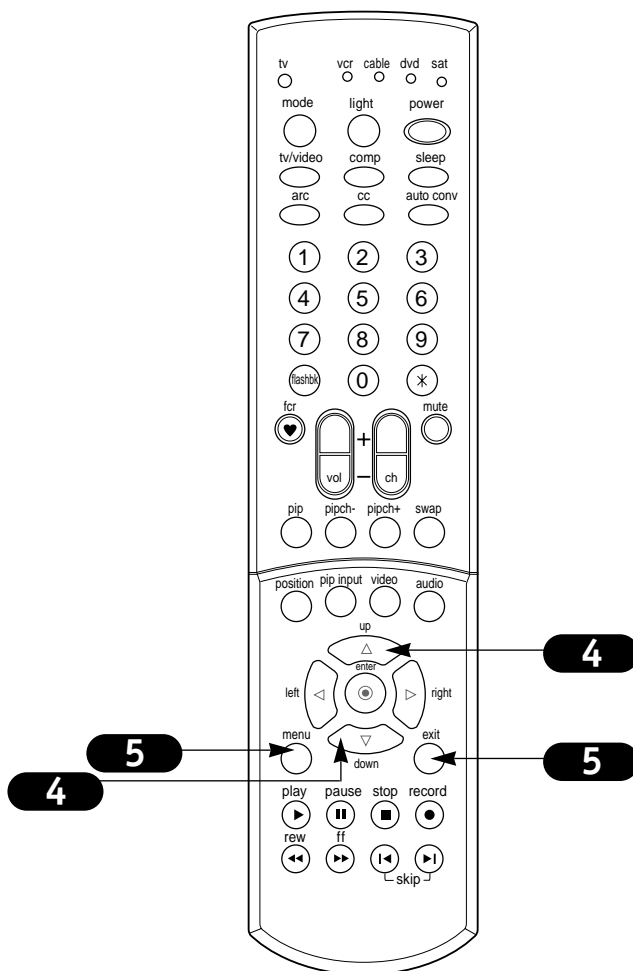

Parental Lock rating descriptions

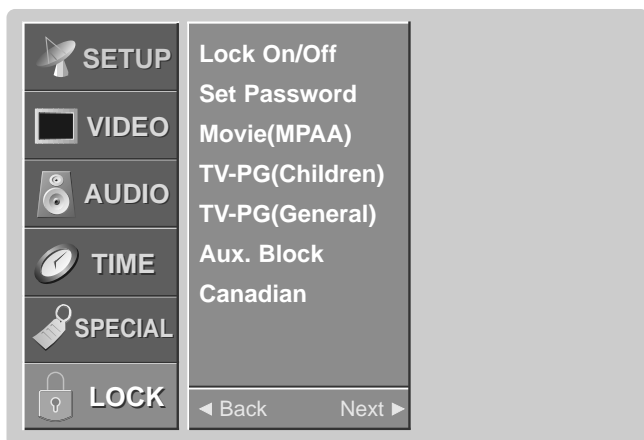

TV-Y7 (Directed to Older Children): Program is designed for children age 7 and above.

TV-G (General audience): Most parents would find this program suitable for all ages.

TV-PG (Parental guidance suggested): Program contains material that parents may find unsuitable for younger children.

TV-14 (Parents strongly cautioned): Program contains some material that many parents would find unsuitable for children under 14 years of age.

TV-MA (Mature audience only): Program is specifically designed to be viewed by adults and therefore may be unsuitable for children under 17.

G - (General audiences): All ages admitted.

PG - Parental guidance suggested: Some program content may not be suitable for children.

PG-13 - Parents strongly cautioned: Some program content may not be appropriate for children under 13.

R - (Restricted): Children under 17 requires accompanying parent or adult guardian.

NC-17: No one 17 and under admitted.

TV-Y (All Children): Program is determined to be appropriate for all children.

X: Adult admitted only.

NR: Not rated movie.

Canadian Lock Rating:

English C: Children
C8+: 8 years and up
G: General programming. Suitable for all audiences.
PG: Parental guidance suggested
14+: Viewers 14 years and up
18+: Adult programming

French G: General
8 ans+: 8 years and up
13 ans+: 13 years and up
16 ans+: 16 years and up
18 ans+: Adults only

Programming the Remote

The remote control for your HD receiver is a multi-brand or universal remote control. It can be programmed to operate most remote-controllable devices of other manufacturers.

Note that the remote control may not control all models of other brands.

- 1** Test your remote control.
To find out whether your remote control can operate the component without programming, turn on the component such as a VCR and press the corresponding mode button (VCR) on the remote control, while pointing at the component. Test the **POWER** and **CH +/-** buttons to see if the component responds properly. If not, the remote requires programming to operate the device.
- 2** Turn on the component to be programmed. Then press the corresponding mode button on the remote control.
- 3** Press the **POWER** button and the **MUTE** button simultaneously. Then the remote control is ready to program the code for the corresponding component.
- 4** There are two ways to find the right code for the component.
 - A. If you press the **CH +/-** buttons repeatedly, the codes will change one at-a-time. Press the **POWER** button after each code change. If the right code is found, the device will turn off.
 - B. Enter a code number using the number buttons on the remote. The right code numbers for the corresponding component can be found on the following pages. Again, if the code is correct, the device will turn off.
- 5** Press the **EXIT** button to store the code.
- 6** Test the remote control functions to see if the component responds properly. If not, repeat from step 2.

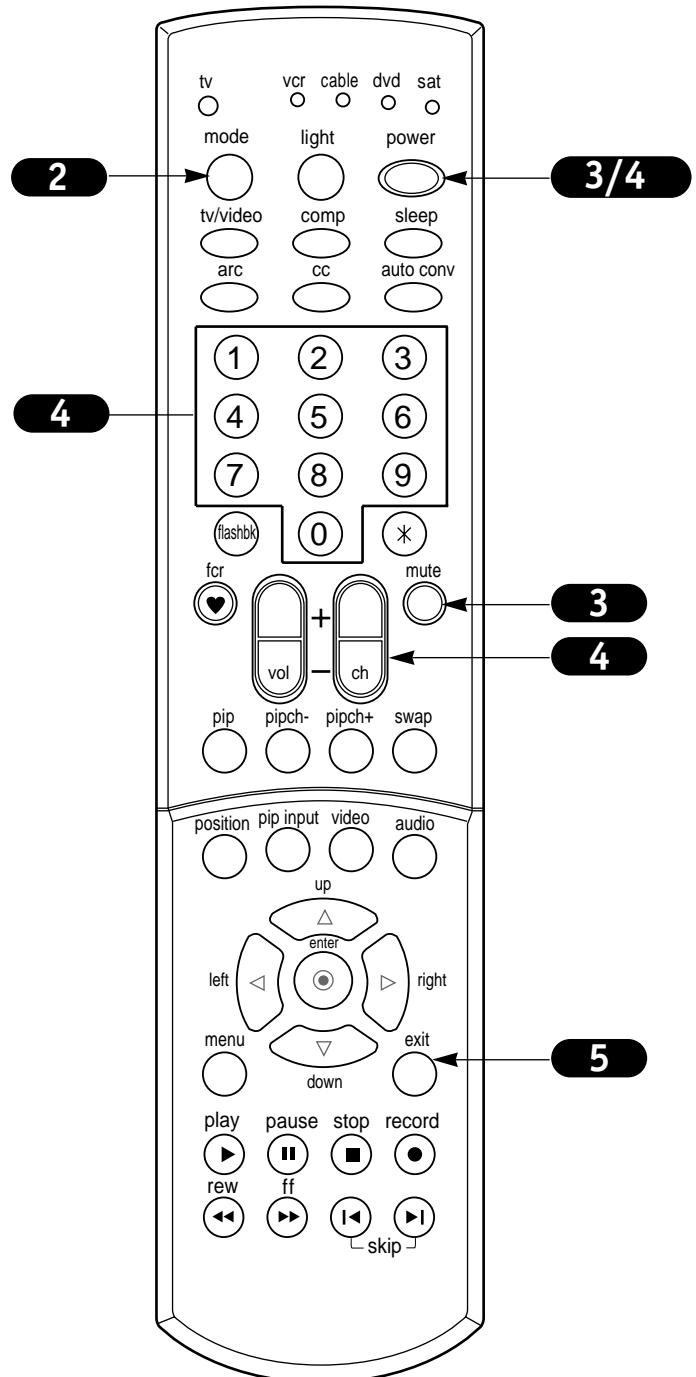

Programming Codes

TVs

Brand	Codes	Brand	Codes	Brand	Codes	Brand	Codes
A MARK	112 143	GOLDSTAR	004 102 106		019 024 040	Sharp	004 014 019
ADMIRAL	072 081 161		110 112 113		056 130 132		022 028 029
AKAI	006 146		116 119 122	NIKEI	134		081 143 170
AMPRO	073 167		127 137 143	ONKING	043		175
AMSTRAD	052	HALL MARK	004 116	ONWA	043	SIEMENS	088
ANAM	043 054 056	HITACHI	004 006 009	OPTONICA	019 081	SIGNATURE	072
	080 104 108		010 011 012	PANASONIC	034 056 080	SONY	041 070 079
	112 115 118		023 041 075		092 164		085 126 139
	121 131		143 158 163	PHILCO	003 004 006	SOUNDESIGN	147 185
AOC	004 006 058		166		024 043 056		003 004 028
	112	INFINITY	164		059 060 063	SPECTRICON	043 116
BLAUPUNKT	088	INKEL	129		064 127 143		112
CANDLE	002 003 004	JBL	164		164	SSS	004 043
	006	JCPENNY	004 006 008	PHILIPS	003 004 005	SUPRE MACY	002
CAPEHART	058		009 024 030		006 038 059	SYLVANIA	003 004 006
CETRONIC	043		065 101 143		070 093 143		044 059 060
CITIZEN	002 003 004		156 160		160 164		063 064 116
	006 043 101	JENSEN	013	PIONEER	006 018 023		127 140 160
	103 143	JVC	034 038 070		025 027 116	TANDY	164
CLASSIC	043		083 145		135 176	TATUNG	081
CONCERTO	004	KEC	043		004 143	TECHNICS	056 062
CONTEC	039 043 050	KENWOOD	006 070	PORTLAND	144 160 161	TECHWOOD	034 080 084
	051	KLOSS	002 059	PROSCAN	165 167	TEKNIKA	004
CORONADO	143	KMC	143	PROTON	004 058 116		002 003 004
CRAIG	043 054	KTV	006 043 143		131 143 171		006 024 028
CROWN	043 143		154		173		031 043 072
CURTIS MATHES	004 006 101	LG	255	QUASAR	034 056 092		077 101 103
	116 143	LODGENET	072	RADIO SHACK	019 043 047	TELEFUNKEN	143
CXC	043	LOGIK	072		116 127 143		037 046 086
DAEWOO	004 016 017	LUXMAN	004	RCA	004 006 023	TELERENT	087
	043 044 055	LXI	007 015 052		024 056 065	TERA	072
	071 076 103		081 160 164		074 144 152	TMK	172
	107 111 114		166		156 160 161	TOSHIBA	004 116
	117 120 123	MAGNAVOX	003 004 006		165		007 015 030
	125 127 128		022 059 060	REALISTIC	007 019 043		040 051 062
	136 143		061 063 064		047	TOTEVISION	101 138
DAYTRON	004 116 143		127 143 160	ROCTEC	186	UNIVERSAL	143
DYNASTY	043		164	RUNCO	168 169	VIDEO CONCEPTS	008 009
DYNATECH	062	MARANTZ	006 077 164	SAMPO	004 006 058		146
ELECTROHOME	024 077 143	MATSUI	164		116	VIDIKRON	174
EMERSON	004 005 006	MEMOREX	004 007 072	SAMSUNG	004 050 089	VIDTECH	004 116
	028 043 047		116		101 105 113	WARDS	004 008 009
	048 050 051	METZ	088		116 127 133		019 028 060
	096 116 143	MGA	004 006 024		137 143 160		061 063 064
	151 153 154		028 042 049	SANYO	007 020 021		072 074 116
	155		077 116		033 039 053	YAMAHA	143 164
FISHER	007 057	MINERVA	088		057 082 166		004 006
FUNAI	028 043	MITSUBISHI	004 006 024	SCOTT	004 028 043	YORK	004 116
FUTURETECH	043		028 040 042		048 116 143	YUPITERU	043
GE	004 006 008		109 116 124	SEARS	004 007 015	ZENITH	001 072 073
	009 034 056		146		028 030 057		095 103 157
	073 074 091	MTC	004 006 062		082 094 101	ZONDA	112
	116 130 144		101		116 143 160		
	155 160 161	NAD	015 025				
	165	NEC	006 007 016				

Programming Codes

VCRs

Brand	Codes	Brand	Codes	Brand	Codes	Brands	Codes
AIWA	034		055 060 130		034 040 041	TOTEVISION	040 101
AKAI	016 043 046		150 152		062 063 107	UNITECH	040
	124 125 146	KENWOOD	014 034 039		109 140 144	VECTOR RESEARCH	012
AMPRO	072		043 047 048		145 147	VICTOR	048
ANAM	031 033 103	LG	255	REALISTIC	003 008 010	VIDEO CONCEPTS	012 034 046
AUDIO DYNAMICS	012 023 039	LLOYD	034		014 031 033	VIDEOSONIC	040
	043	LXI	003 009 013		034 040 053	WARDS	003 013 017
BROKSONIC	035 037 129		014 017 034		054 101		024 031 033
CANON	028 031 033		101 106	RICO	058		034 040 053
CAPEHART	108	MAGIN	040	RUNCO	148		054 131
CRAIG	003 040 135	MAGNAVOX	031 033 034	SALORA	014	YAMAHA	012 034 039
CURTIS MATHES	031 033 041		041 067 068	SAMSUNG	032 040 102		043
DAEWOO	005 007 010	MARANTZ	012 031 033		104 105 107	ZENITH	001 034 048
	064 065 108		067 069		109 112 113		056 058 072
	110 111 112	MARTA	101		115 120 122		080 101
	116 117 119	MATSUI	027 030		125		
DAYTRON	108	MEI	031 033	SANSUI	022 043 048		
DBX	012 023 039	MEMOREX	003 010 014		135		
	043		031 033 034	SANYO	003 007 010		
DYNATECH	034 053		053 072 101		014 102 134		
ELECTROHOME	059		102 134 139	SCOTT	017 037 112		
EMERSON	006 017 025	MGA	045 046 059		129 131		
	027 029 031	MINOLTA	013 020	SEARS	003 008 009		
	034 035 036	MITSUBISHI	013 020 045		010 013 014		
	037 046 101		046 049 051		017 020 031		
	129 131 138		059 061 151		042 073 081		
	153	MTC	034 040		101		
FISHER	003 008 009	MULTITECH	024 034	SHARP	031 054 149		
	010	NEC	012 023 039	SHINTOM	024		
FUNAI	034		043 048	SONY	003 009 031		
GE	031 033 063	NORDMENDE	043		052 056 057		
	072 107 109	OPTONICA	053 054		058 076 077		
	144 147	PANASONIC	066 070 074		078 149		
GO VIDEO	132 136		083 133 140	SOUNDESIGN	034		
GOLDSTAR	012 013 020		145	STS	013		
	101 106 114	PENTAX	013 020 031	SYLVANIA	031 033 034		
	123		033 063		059 067		
HARMAN KARDON	012 045	PHILCO	031 034 067	SYMPHONIC	034		
HITACHI	004 018 026	PHILIPS	031 033 034	TANDY	010 034		
	034 043 063		054 067 071	TATUNG	039 043		
	137 150		101	TEAC	034 039 043		
INSTANTREPLAY	031 033	PILOT	101	TECHNICS	031 033 070		
JCL	031 033	PIONEER	013 021 048	TEKNIKA	019 031 033		
JCPENNY	012 013 015	PORTLAND	108		034 101		
	033 040 066	PULSAR	072	THOMAS	034		
	101	QUARTZ	011 014	TMK	006		
JENSEN	043	QUASAR	033 066 075	TOSHIBA	008 013 042		
JVC	012 031 033		145		047 059 082		
	043 048 050	RCA	013 020 033		112 131		

Programming Codes

SAT

Brand	Codes	Brand	Codes	Brand	Codes	Brand	Codes
ALPHASTAR DSR	123		027 133 134	PERSONAL CABLE	117	VIEWSTAR	115
AMPLICA	050	GENERAL INSTRUMENT	003 004 016	PHILIPS	071	WINEGARD	128 146
BIRDVIEW	051 126 129		029 031 059	PICO	105	ZENITH	001 081 082
BSR	053		101	PRESIDENT	019 102		083 084 091
CAPETRONICS	053	HITACHI	139 140	PRIMESTAR	030 110 111		120
CHANNEL MASTER	013 014 015	HOUSTON TRACKER	033 037 039	PROSAT	072		
	018 036 055		051 057 104	RCA	066 106		
CHAPARRAL	008 009 012	HUGHES	068	REALISTIC	043 074		
	077	HYTEK	053	SAMSUNG	123		
CITOH	054	JANIEL	060 147	SATELLITE SERVICE CO	028 035 047		
CURTIS MATHES	050 145	JERROLD	061		057 085		
DRAKE	005 006 007	KATHREIN	108	SCIENTIFIC ATLANTA	032 138		
	010 011 052	LEGEND	057	SONY	103		
	112 116 141	LG	255	STARCAST	041		
DX ANTENNA	024 046 056	LUTRON	132	SUPER GUIDE	020 124 125		
	076	LUXOR	062 144	TEECOM	023 026 075		
ECHOSTAR	038 040 057	MACOM	010 059 063		087 088 090		
	058 093 094		064 065	TOSHIBA	002 127		
	095 096 097	MEMOREX	057	UNIDEN	016 025 042		
	098 099 100	NEXTWAVE	028 124 125		043 044 045		
	122	NORSAT	069 070		048 049 078		
ELECTRO HOME	089	PACE SKY SATELLITE	143		079 080 086		
EUROPLUS	114	PANASONIC	060 142		101 135 136		
FUJITSU	017 021 022	PANSAT	121				

DVD

Brand	Codes	Brand	Codes	Brand	Codes	Brand	Codes
APEX DIGITAL	022		025	PHILIPS	013	THOMPSON	005 006
DENON	020 014	MAGNAVOX	013	PIONEER	004 026	TOSHIBA	019 008
GE	005 006	MARANTZ	024	PROCEED	021	YAMAHA	009 018
GOLDSTAR	010 016 025	MITSUBISHI	002	PROSCAN	005 006	ZENITH	010 016 025
HARMAN KARDON	027	NAD	023	RCA	005 006		
JVC	012	ONKYO	008 017	SAMSUNG	011 015		
LG	001 010 016	PANASONIC	003 009	SONY	007		

Programming Codes

CATV

Brand	Codes	Brand	Codes	Brand	Codes	Brand	Codes
ABC	003 004 039		008 009 010	REGAL	049 050		032 035
	042 046 052		052 069 074	REGENCY	057	VIEWSTAR	012 015 018
	053	LG	255	REMBRANT	025		086 087 088
ANTRONIK	014	M-NET	037	RK	091		089
ARCHER	005 007 014	MACOM	033	SAMSUNG	030 068	ZENITH	001 060 093
	024	MAGNAVOX	010 012 064	SCIENTIFIC ATLANTA	003 011 041		
CABLE STAR	026		079		042 043 045		
CENTURION	092	MEMOREX	001		046		
CENTURY	007	MOVIE TIME	028 032	SHERITECH	022		
CITIZEN	007	NSC	015 028 038	SIGNAL	030		
COLOUR VOICE	065 090		071 073	SIGNATURE	052		
COMBANO	080 081	OAK	016 031 037	SL MARX	030		
COMTRONICS	019 030		053	SPRUCER	047 078		
DIAMOND	023	PANASONIC	044 047	STARCOM	002 004 008		
EAGLE	020 030 040	PARAGON	001		009		
EASTERN	057 062 066	PHILIPS	006 012 013	STARGATE	008 030		
ELECTRICORD	032		020 065 085	SYLVANIA	067		
GE	072		090	TADIRAN	030		
GEMINI	008 022 025	PIONEER	034 051 052	TANDY	017		
	054		063 076	TEXSCAN	029 067		
GI	052 074	POST NEWS WEEK	016	TOCOM	039 040 056		
GOLDEN CHANNEL	030	PRUCER	059	TOSHIBA	001		
HAMLIN	049 050 055	PTS	011 048 071	UNIKA	007 014 024		
HITACHI	052 055		072 073 074	UNITED CABLE	004 053		
HOSPITALITY	070 077	PULSAR	001	UNIVERSAL	005 007 014		
JERROLD	002 003 004	RCA	047		024 026 027		

Early malfunctions can be prevented. Careful and regular cleaning can extend the amount of time you will have your new TV. Be sure to turn the power off and pull out the power cord before you begin any cleaning.

SCREEN CLEANING

1. Here's a great way to keep the dust off your screen for a while. Wet a soft cloth in a mixture of lukewarm water and a little fabric softener or dish washing detergent. Wring the cloth until it's almost dry, and then use it to wipe the screen.
2. Make sure the excess water is off the screen, and then let it air-dry before you turn on your TV.

CABINET CLEANING

1. Use a soft cloth with a mild soap solution to wipe the cabinet.
2. Rinse the cloth and wipe the cabinet again.
3. Let the cabinet air-dry before turning the TV on.

WOOD CABINETS

Use a quality wood cleaner and polish. This will protect the TV from dirt and dust, as well as keep the cabinet looking new.

EXTENDED ABSENCE



If you leave your TV dormant for a long time (such as a vacation), it's a good idea to unplug the power cord to protect against possible damage from lightning or power surges. If you use an off-air antenna, you may also want to disconnect it from the back of your TV before leaving.

PICTURE INTERFERENCE

Even though you may be getting cable, the signal may be weak, which means the quality of your picture may suffer due to other factors. If there are problems with the image on your TV, consult the Troubleshooting guide on the following pages. You may also want to contact your cable service provider to determine if the problem is from the cable service.

VIDEO GAMES AND OTHER FIXED-PATTERN DISPLAYS

If you use your TV to play video games or for other uses that have single, fixed images, such as a photo-CD player, you should avoid setting the Brightness level too high. If static images, like network identification patterns, are left on the screen for too long, they can leave a permanent impression on the TV screen. You can reduce the chance of this happening by limiting the amount of time you use the fixed-image display, and by reducing the contrast and brightness levels.



If you unplug your TV, you may have to reset the clock using the Time menu described earlier.

Troubleshooting

Some quick and easy tips to fixing problems yourself.

SYMPTOM	POSSIBLE SOLUTIONS
Snowy picture and unclear sound.	<ul style="list-style-type: none">• Check your antenna connection or location.• Check your cable input.• Check to see if the TV/VCR button on your VCR has the TV selected.
Multiple images or 'ghost shadows.'	<ul style="list-style-type: none">• Check your antenna direction and/or location.• Check your cable input.• Make sure the cable from your antenna to your TV is properly connected.
Interference: Sharp lines across the screen and unclear sound.	<p><i>The following may cause image problems or distortion: Electrical appliances, powerful lights, cars, trucks; computers or portable phones; medical equipment</i></p> <ul style="list-style-type: none">• If possible increase the distance between your TV and the offending appliance, or shut one of them off.
Normal picture but no sound.	<ul style="list-style-type: none">• Check volume levels.• Make sure the TV is not Muted.• Try another channel. The problem may be with the broadcast, not your TV.• Are the Audio cables installed properly?• Are the wires for external speakers (if you have external speakers) installed properly?• Make sure your speakers are turned on in the Audio menu.• If your audio mode is set to SAP, the program may not have SAP.
No picture and unclear sound.	<ul style="list-style-type: none">• Are you in TV or cable tuning mode, and should be in the other?• Make sure output channels on all A/V equipment are on the same channel (3 or 4).• Check that all connections are tight.
No picture and no sound.	<ul style="list-style-type: none">• Is the AC power plugged in?• Check that your AC power outlet works. (Test it by plugging in something else or try another power outlet.)• Make sure your brightness and audio controls are set properly.• Try another channel. The problem may be with the broadcast.
No color, but the sound is O.K.	<ul style="list-style-type: none">• Check the color control in the Video menu.• Try another channel. The problem may be with the broadcast.
Picture has a big black box on it, but the sound is O.K.	<ul style="list-style-type: none">• The CC (closed caption) option may be in Text mode. Select Caption 1, in the Captions/Text menu., or OFF in the Captions menu.
Picture has two horizontal black bars, one on top and one on bottom.	<ul style="list-style-type: none">• Select correct Aspect Ratio in Special menu or with ARC button.
Missing Secret Lock Code	<ul style="list-style-type: none">• If you forgot your password, when the display asks you to enter the secret code, press '7', '7', '7', '7' on the remote control.

SYMPTOM	POSSIBLE SOLUTIONS
Remote control doesn't work.	<ul style="list-style-type: none">• Make sure the batteries are fresh and installed properly.
Menu options can't be changed or selected.	<ul style="list-style-type: none">• Try unplugging your TV for a few minutes, then plug it back in.
No picture or sound when any non-cable source is selected.	<ul style="list-style-type: none">• Check to see if the source equipment has been turned on.• Make sure that the connections are secure on the back of your TV and on the source equipment.
Weak or no Stereo Sound when using a stereo VCR.	<ul style="list-style-type: none">• Check to see if all the connections are secure.• Look in the Audio mode menu to see if all the settings are correct.• You are using channel 3 or 4 to view your VCR. No stereo sound is present under that decision.
The PIP inset is black or lacks contrast.	<ul style="list-style-type: none">• Check to be sure that the PIP source is turned on.• Check that all the wires are connected properly.• Check to see if your input source for PIP is set correctly.
The PIP inset is "snowy" when the source is TV.	<ul style="list-style-type: none">• Look to see if the TV/VCR button on your VCR has the TV selected or change the PIP to another source.
Time is incorrect.	<ul style="list-style-type: none">• Make sure the time was set initially. Probably power was lost.

Glossary

A list of definitions for some of the words found in this guide.

75 OHM RF CABLE	The round cable that comes from an off-air antenna or cable service provider. Each end looks like a hex shaped nut with a wire sticking through the middle, and it screws onto the threaded jack on the back of your TV.
A/V CABLES	Audio/Video cables. Three cables - Right audio (red), Left audio (white), and Video (yellow). A/V cables are used for stereo playback of videocassettes and for higher quality picture and sound from other A/V devices.
A/V DEVICE	Any device that produces video or sound (VCR, DVD, cable box, or television).
ADD	This function lets you add new channels to the channel list in memory that you'll scroll through when using your remote.
AMPLIFIER	An external device that amplifies sound from a television, CD player, VCR, DVD or other A/V device.
ANALOG TV	Traditional method of representing a television signal as a replica (analog) of the original picture and sound.
ANTENNA	The physical receiver of television signals sent over the air. A large metal piece of equipment does not always have to be visible for your home to be using an antenna.
ARC (Aspect Ratio Control)	The ratio of the horizontal dimension to the vertical dimension of a picture. Standard television in the U.S. today is generally transmitted and displayed in a 4:3 aspect ratio. High-Definition television will normally be formatted in a wider aspect ratio, assumed to be 16:9.
CAPTIONS	A form of subtitling that writes out the dialog for your program on the screen.
CONVERGENCE	This option lets you correct for color separation in your picture.
DELETE	This function lets you remove channels that you don't watch from the channel list in memory.
DIGITAL TV	A new method of representing a television signal as a series of binary numbers (1s and 0s). This method allows the signal to be manipulated to eliminate redundancy and dramatically increase picture and sound quality.
DOLBY DIGITAL	Dolby Digital Cinema Sound is made possible by a new digital coding technique called Dolby AC-3. Dolby AC-3 produces high-quality, 5.1 channel surround sound which is six discrete separate channels for a full range of sound. Each channel can carry a different signal simultaneously (front center, front left, front right, surround left, surround right and subwoofer).

Glossary continued

A list of definitions for some of the words found in this guide.

FAVORITE CHANNELS	This function created a customized list of your favorite channels. You can access this group of channels with the FCR button on the remote by pressing FCR repeatedly.
INPUT	Refers to the jack that receives a signal into the TV, VCR or other A/V device.
JACK	A connection on the back of a TV, VCR, or any other A/V device. This includes the RF jacks and the Audio/Video jacks that are color-coded.
MODE	The mode determines the type of device (TV, VCR, Cable, Aux) that the remote is controlling; remote operating mode.
MONO SOUND	Mono (monaural) sound is one channel of sound. On more than one speaker, all the speakers play the same audio.
OUTPUT	Refers to the jack that sends a signal out of a VCR, DVD, or other A/V device.
PIP	This is the most common way to refer to the Picture-In-Picture (PIP) option.
SECOND AUDIO PROGRAMMING/SAP	Second Audio Programming (SAP) is another, separate, audio channel available with some programming. Choosing SAP often refers to listening to audio in another language, such as Spanish or French.
SIGNAL	Picture and sound traveling through cable, or on the air, to your television screen.
SOURCE	The term for the equipment that provides audio and video information to your TV. Antenna, VCR, DVD players, and Cable Boxes are examples of sources.
STEREO SOUND	Stereo (stereophonic) sound refers to audio that's divided into right and left sides.
TEXT	Arbitrary text not related to the program.
TUNER	Any device that picks up broadcast signals and turns them into picture and sound.

Product Specifications

Specifications

Power requirements	120V, 60 Hz	
Number of inputs/outputs		
Video (In)	3	1 Vp-p, 75 ohms unbalanced, sync negative
Video (Out)	1	
S Video (In)	2	Y: 1 Vp-p, 75 ohms unbalanced, sync negative C: 0.280 Vp-p (burst signal), 75 ohms
Audio (In)	5	500 mVrms (100% modulation), Impedance: 47 kilohms
Audio (Out)	1	More than 408 mVrms at the maximum volume setting (variable) Impedance (output): 2 kilohms
Component input	2 2 2	Y: 1.0 Vp-p, 75 ohms w/sync PB: 0.7 Vp-p, 75 ohms PR: 0.7 Vp-p, 75 ohms
Speaker output (W)	15W x2	
Power consumption (W)		
In use (max.)	300W	
In standby	2W	
TV		
Weight (lbs)	145.5 (R49W36), 158.7 (R56W36)	
Television system	American TV Standard, NTSC, ATSC with STB	
Channel coverage	VHF: 2 - 13 UHF: 14 - 69 CATV: 1 - 125	
Antenna	75 ohm external terminal for VHF/UHF	
Supplied accessories	Remote control, batteries 2 size AA (Alkaline battery)	
Screen Aspect Ratio	16 x 9	



Design and specifications are subject to change without prior notice.

ZENITH ELECTRONICS CORPORATION

Projection TV Limited Warranty - USA



Zenith will repair or replace your product, at Zenith's option, if it proves to be defective in material or workmanship under normal use, during the warranty period ("Warranty Period") listed below, effective from the date ("Date of Purchase") of original consumer purchase of the product. This warranty is good only to the original purchaser of the product and effective only when used in the United States, excluding U.S. Territories.

<p>WARRANTY PERIOD:</p> <p>LABOR: One Year from the Date of Purchase.</p> <p>Parts: One Year from the Date of Purchase.</p> <p>CRT Picture Tubes: 2 Years from the Date of Purchase.</p> <p>* Parts replaced are warranted for the remaining portion of the original warranty period.</p>	<p>HOW SERVICE IS HANDLED:</p> <p>In-Home Service: Please retain dealer's dated bill of sale or delivery ticket as evidence of the Date of Purchase for proof of warranty, and submit a copy of the bill of sale to the service person at the time warranty service is provided.</p> <p>Please call 1-877-9Zenith (1-877-993-6484) to locate your nearest Zenith Authorized Service Center.</p> <p>Replacement parts may be new or factory remanufactured.</p>
---	---

THIS WARRANTY IS IN LIEU OF ANY OTHER WARRANTIES, EXPRESS OR IMPLIED, INCLUDING WITHOUT LIMITATION, ANY WARRANTY OF MERCHANTABILITY OR FITNESS FOR A PARTICULAR PURPOSE. TO THE EXTENT ANY IMPLIED WARRANTY IS REQUIRED BY LAW, IT IS LIMITED IN DURATION TO THE EXPRESS WARRANTY PERIOD ABOVE. ZENITH WILL NOT BE LIABLE FOR ANY INCIDENTAL, CONSEQUENTIAL, INDIRECT, SPECIAL OR PUNITIVE DAMAGES OF ANY NATURE, EVEN IF ADVISED OF THE POSSIBILITY OF SUCH DAMAGES, INCLUDING WITHOUT LIMITATION, LOST REVENUES OR PROFITS, LOST OR CORRUPTED PROGRAMMING OR DATA, OR ANY OTHER DAMAGE WHETHER BASED IN CONTRACT, TORT, OR OTHERWISE. Some states do not allow the exclusion or limitation of incidental or consequential damages or limitation on how long an implied warranty lasts, so the above exclusion or limitation may not apply to you. This warranty gives you specific legal rights and you may also have other rights that may vary from state to state.

THIS LIMITED WARRANTY DOES NOT APPLY TO:

1. Damages or operating problems that result from shipping, installation, adjustment of user controls, calibration, maintenance or failure to maintain, or separate system components; and
2. Damages or operating problems that result from normal wear and tear, misuse, abuse, operation outside environmental specifications or contrary to the requirements or precautions in the Operating Guide, accident, lightning strikes or other natural causes, unauthorized modification or alteration, incorrect electrical current or voltage, reception problem caused by inadequate home antenna or faulty antenna connections, computer software, institutional or commercial use, or other causes not arising out of defect in material or workmanship.
3. **Therefore, the cost of repair or replacement of such a defective product shall be borne by the consumer.**

CUSTOMER INTER-ACTIVE CENTER NUMBERS:

<p>For nearest Authorized Service Center, Where to buy, Product Assistance, or Customer Assistance</p>	<p>Call 1-877-9Zenith (1-877-993-6484) (Monday~ Friday, 7 AM ~ 8 PM CT and Saturday, 8 AM ~ 5 PM CT) and select an appropriate option from the menu.</p> <p>Or visit our website at http://www.zenithservice.com</p>
---	---

ZENITH ELECTRONICS CORPORATION
2000 MILLBROOK DRIVE
LINCOLNSHIRE, IL 60069

Zenith Part No. 206-3865

P/N : 3828VA0220N@(SP02PC)

Free Manuals Download Website

<http://myh66.com>

<http://usermanuals.us>

<http://www.somanuals.com>

<http://www.4manuals.cc>

<http://www.manual-lib.com>

<http://www.404manual.com>

<http://www.luxmanual.com>

<http://aubethermostatmanual.com>

Golf course search by state

<http://golfingnear.com>

Email search by domain

<http://emailbydomain.com>

Auto manuals search

<http://auto.somanuals.com>

TV manuals search

<http://tv.somanuals.com>