

Installation and Operating Guide | Warranty

Model Numbers | Z52DC2D/Z56DC1D/Z62DC1D | DLP PROJECTION



ENERGY STAR is a set of power-saving guidelines issued by the U.S. Environmental Protection Agency(EPA).



As an ENERGY STAR Partner LGE U.S.A., Inc. has determined that this product meets the ENERGY STAR guidelines for energy efficiency.



© Copyright 2006, LG Electronics USA, Inc.

Warning/Cautions



WARNING/CAUTION
RISK OF ELECTRIC SHOCK
DO NOT OPEN



WARNING/CAUTION:

TO REDUCE THE RISK OF ELECTRIC SHOCK DO NOT REMOVE COVER (OR BACK). NO USER SERVICEABLE PARTS INSIDE. REFER TO QUALIFIED SERVICE PERSONNEL.



The lightning flash with arrowhead symbol, within an equilateral triangle, is intended to alert the user to the presence of uninsulated "dangerous voltage" within the product's enclosure that may be of sufficient magnitude to constitute a risk of electric shock to persons.



The exclamation point within an equilateral triangle is intended to alert the user to the presence of important operating and maintenance (servicing) instructions in the literature accompanying the appliance.

WARNING/CAUTION:

TO PREVENT FIRE OR SHOCK HAZARDS, DO NOT EXPOSE THIS PRODUCT TO RAIN OR MOISTURE.

POWER CORD POLARIZATION:

CAUTION: TO PREVENT ELECTRIC SHOCK, MATCH WIDE BLADE OF PLUG TO WIDE SLOT, FULLY INSERT.

ATTENTION: POUR ÉVITER LES CHOCS ÉLECTRIQUES, INTRODUIRE LA LAME LA PLUS LARGE DE LA FICHE DANS LA BORNE CORRESPONDANTE DE LA PRISE ET POUSSER JUSQU'AU FOND.

NOTE TO CABLE/TV INSTALLER:

This reminder is provided to call the CATV system installer's attention to Article 820-40 of the National Electric Code (U.S.A.). The code provides guidelines for proper grounding and, in particular, specifies that the cable ground shall be connected to the grounding system of the building, as close to the point of the cable entry as practical.

REGULATORY INFORMATION:

This equipment has been tested and found to comply with the limits for a Class B digital device, pursuant to Part 15 of the FCC Rules. These limits are designed to provide reasonable protection against harmful interference in a residential installation. This equipment generates, uses and can radiate radio frequency energy and, if not installed and used in accordance with the instructions, may cause harmful interference to radio communications. However, there is no guarantee that interference will not occur in a particular installation. If this equipment does cause harmful interference to radio or television reception, which can be determined by turning the equipment off and on, the user is encouraged to try to correct the interference by one or more of the following measures:

- Reorient or relocate the receiving antenna.
- Increase the separation between the equipment and receiver.
- Connect the equipment into an outlet on a circuit different from that to which the receiver is connected.
- Consult the dealer or an experienced radio/TV technician for help.

Any changes or modifications not expressly approved by the party responsible for compliance could void the user's authority to operate the equipment.

CAUTION:

Do not attempt to modify this product in any way without written authorization from LG Electronics. Unauthorized modification could void the user's authority to operate this product.

COMPLIANCE:

The responsible party for this device compliance is:
Zenith Electronics Corporation
1-201-816-2000

Marked and Distributed in the United States by LG Electronics U.S.A., Inc.
1000 Sylvan Avenue, Englewood Cliffs, NJ 07632
<http://www.zenith.com>

Safety Instructions

IMPORTANT SAFETY INSTRUCTIONS

Important safety instructions shall be provided with each apparatus. This information shall be given in a separate booklet or sheet, or be located before any operating instructions in an instruction for installation for use and supplied with the apparatus. This information shall be given in a language acceptable to the country where the apparatus is intended to be used. The important safety instructions shall be entitled "Important Safety Instructions". The following safety instructions shall be included where applicable, and, when used, shall be verbatim as follows. Additional safety information may be included by adding statements after the end of the following safety instruction list. At the manufacturer's option, a picture or drawing that illustrates the intent of a specific safety instruction may be placed immediately adjacent to that safety instruction :

1. Read these instructions.
2. Keep these instructions.
3. Heed all warnings.
4. Follow all instructions.
5. Do not use this apparatus near water.
6. Clean only with dry cloth.
7. Do not block any ventilation openings. Install in accordance with the manufacturer's instructions.
8. Do not install near any heat sources such as radiators, heat registers, stoves, or other apparatus (including amplifiers) that produce heat.
9. Do not defeat the safety purpose of the polarized or grounding-type plug. A polarized plug has two blades with one wider than the other. A grounding type plug has two blades and a third grounding prong. The wide blade or the third prong are provided for your safety. If the provided plug does not fit into your outlet, consult an electrician for replacement of the obsolete outlet.
10. Protect the power cord from being walked on or pinched particularly at plugs, convenience receptacles, and the point where they exit from the apparatus.
11. Only use attachments/accessories specified by the manufacturer.
12. Use only with the cart, stand, tripod, bracket, or table specified by the manufacturer, or sold with the apparatus. When a cart is used, use caution when moving the cart/apparatus combination to avoid injury from tip-over.



PORTABLE CART WARNING

Safety Instructions

13. Unplug this apparatus during lightning storms or when unused for long periods of time.

14. Refer all servicing to qualified service personnel. Servicing is required when the apparatus has been damaged in any way, such as power-supply cord or plug is damaged, liquid has been spilled or objects have fallen into the apparatus, the apparatus has exposed to rain or moisture, does not operate normally, or has been dropped.

15. CAUTION concerning the Power Cord :

Most appliances recommend they be placed upon a dedicated circuit; that is, a single outlet circuit which powers only that appliance and has no additional outlets or branch circuits. Check the specification page of this owner's manual to be certain.

Do not overload wall outlets. Overloaded wall outlets, loose or damaged wall outlets, extension cords, frayed power cords, or damaged or cracked wire insulation are dangerous. Any of these conditions could result in electric shock or fire. Periodically examine the cord of your appliance, and if its appearance indicates damage or deterioration, unplug it, discontinue use of the appliance, and have the cord replaced with an exact replacement part by an authorized servicer.

Protect the power cord from physical or mechanical abuse, such as being twisted, kinked, pinched, closed in a door, or walked upon. Pay particular attention to plugs, wall outlets, and the point where the cord exits the appliance.

16. Outdoor Use Marking :

WARNING - To Reduce The Risk Of Fire Or Electric Shock, Do Not Expose This Appliance To Rain Or Moisture.

17. Wet Location Marking :

Apparatus shall not be exposed to dripping or splashing and no objects filled with liquids, such as vases, shall be placed on the apparatus.



SRS is a trademark of SRS Labs, Inc. TruSurround XT technology is incorporated under license from SRS Labs, Inc.



High-definition television. High-resolution digital television broadcast and playback system composed of roughly a million or more pixels, 16:9 aspect-ratio screens, and AC3 digital audio. A subset of digital television, HDTV formats include 1080i and 720p resolutions.



Manufactured under license from Dolby Laboratories. "Dolby" and the double-D symbol are trademarks of Dolby Laboratories.



HDMI™, the HDMI logo and High-Definition Multimedia Interface are trademarks or registered trademarks of HDMI Licensing."

Contents

Warning/Caution	2	Audio Menu Options	
Safety Instructions	3~4	Audio Language	32
Introduction		Auto Volume Leveler (EZ SoundRite)	32
Controls/Connection Options	6~9	Auto Sound Control (EZ Sound)	32
Remote Control Key Functions	11~12	Manual Sound Control (EZ sound-User Option)	33
Installation		Balance	34
External Equipment Connections	13~18	TV Speakers On/Off Setup	34
Antenna Connection	13	Time Menu Options	
VCR Setup	14	Auto Clock Setup	35
External A/V Source Setup	15	Manual Clock Setup	35
DVD Setup	15	On/Off Timer Setup	36
HDSTB Setup	16	Sleep Timer	36
AV Out Setup	16	Auto Off	37
Digital Audio Output	17	Option Menu Features	
PC Setup	18~20	Aspect Ratio Control	38
Operation		Caption / Text	39
Turning the TV On	21	Caption Option	40
TV Setup		Low Power	40
On-screen Menus Language Selection	22	Lock Menu Options	
Channel Selection	22	Parental Lock Setup	42
Volume Adjustment	22	Split Zoom	43
Setup Menu Options		EPG (Electronic Program Guide) (In DTV mode) ..	43
EZ Scan (Channel Search)	23	Brief Info.	44
Manual Scan	23	Programming the Remote	45
Channel Edit	24	Programming Codes	46~48
DTV Signal	24	Troubleshooting Checklist	49~50
Input Source Selection	25	Maintenance	51
Input Label	25	Product Specifications	51
Video Menu Options		Warranty	52
Auto Picture Control (EZ Picture)	26		
Adaptive Picture Mode (APM)	26		
Color Temperature Control	27~28		
XD	29		
Advanced-Cinema 3:2 Mode / Black Level	30		
Video Reset	31		

After reading this manual, keep it handy for future reference.

Controls

- This is a representation of the front panel of models Z56DC1D, Z62DC1D series TVs.
- Here shown may be somewhat different from your TV.

Front Panel Controls

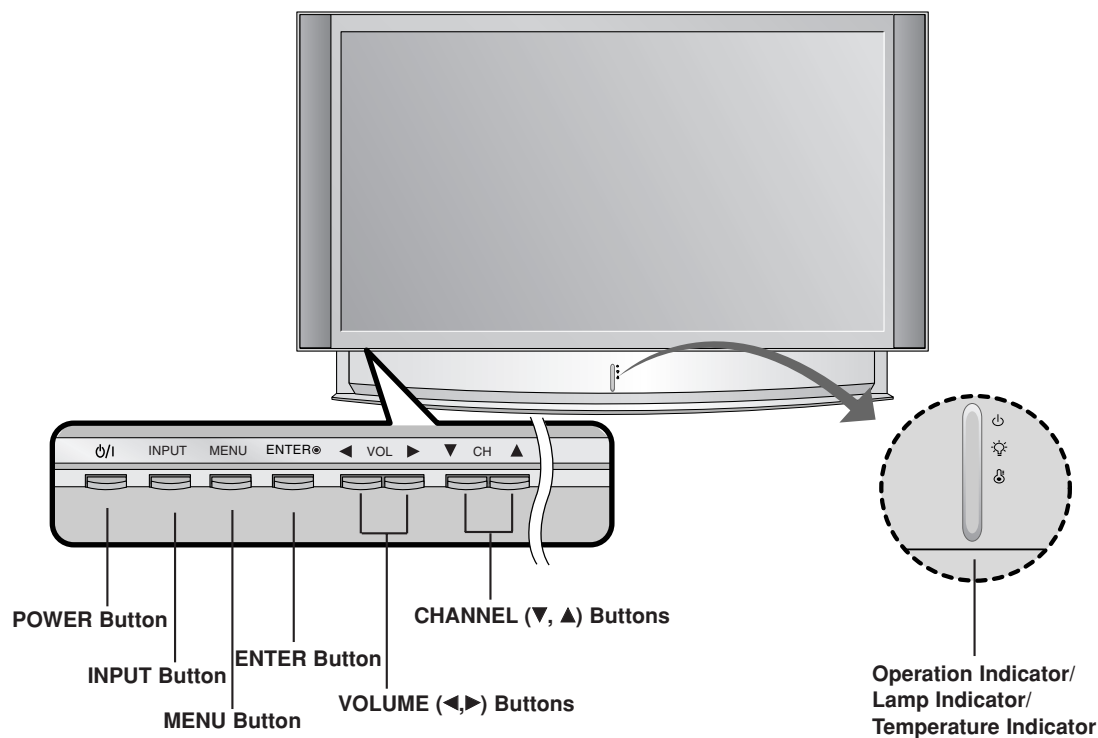

Function Status Indicators

- Lamp indicator, operation indicator, and temperature indicator located below the front panel controls, reveal the operating status of the DLP projection TV.

Operation Indicator	Off	Power Cord is not connected.
	Red	Power Cord is connected, TV is in standby mode.
	Green	TV turns on.
	Orange (blinking)	Preparing operation in standby mode.
Lamp Indicator	Orange	Projection lamp is reaching the end of its life and needs to be replaced with a new lamp. Contact your service center.
	Red (blinking)	There is a problem with the lamp or around it. Contact an authorized service center.
	Green (blinking)	The lamp cover is not closed.
Temperature Indicator	Orange	The projection TV is overheating. Check the blocked vents of the Projection TV .
	Red	The projection TV shuts down due to overheating.
	Red (blinking)	The projection TV shuts down, check the cooling fan. Contact your service center.

Connection Options

- This is the back panel of models Z56DC1D, Z62DC1D series TVs.

Back Connection Panel

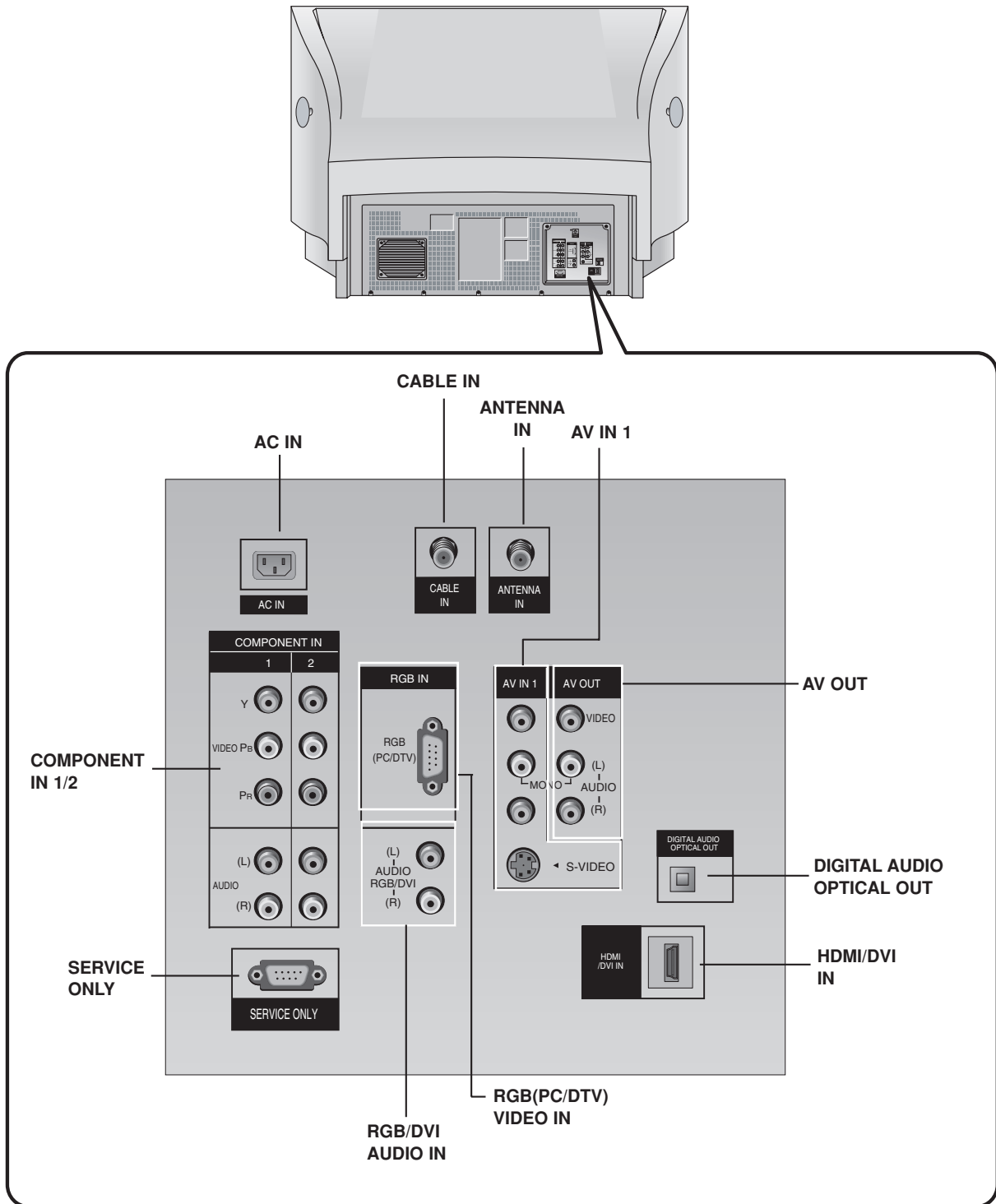

Controls

- This is a representation of the front panel of models Z52DC2D series TVs.
- Here shown may be somewhat different from your TV.

Front Panel Controls

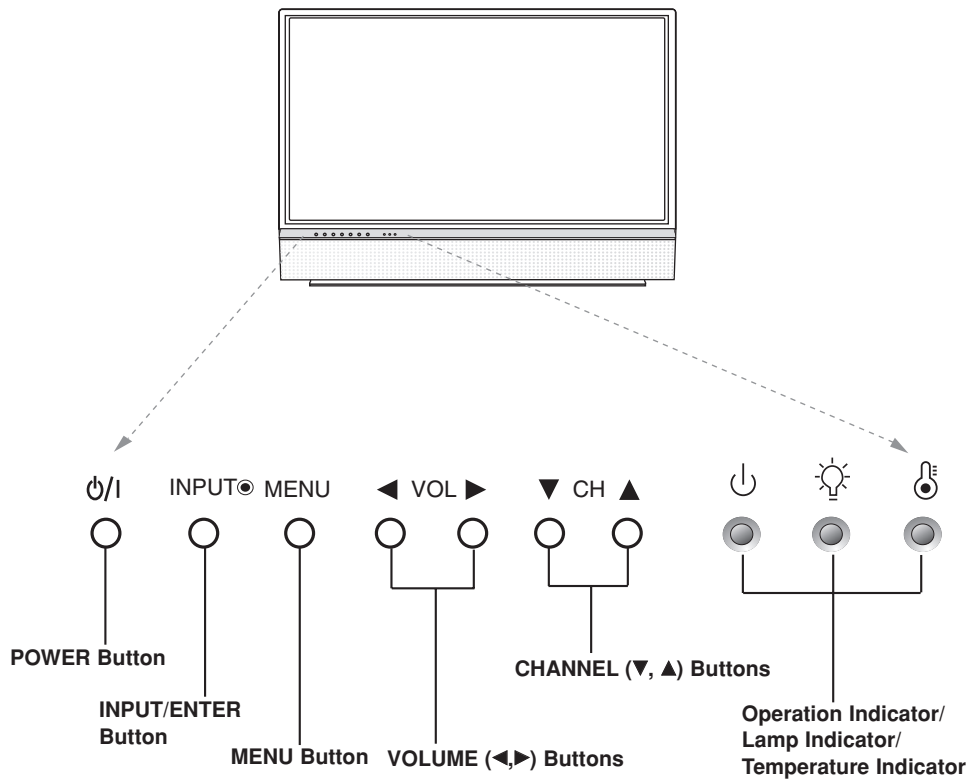

Function Status Indicators

- Lamp indicator, operation indicator, and temperature indicator located below the front panel controls, reveal the operating status of the DLP projection TV.

Operation Indicator	Off	Power Cord is not connected.
	Red	Power Cord is connected, TV is in standby mode.
	Green	TV turns on.
	Orange (blinking)	Preparing operation in standby mode.
Lamp Indicator	Orange	Projection lamp is reaching the end of its life and needs to be replaced with a new lamp. Contact your service center.
	Red (blinking)	There is a problem with the lamp or around it. Contact an authorized service center.
	Green (blinking)	The lamp cover is not closed.
Temperature Indicator	Orange	The projection TV is overheating. Check the blocked vents of the Projection TV .
	Red	The projection TV shuts down due to overheating.
	Red (blinking)	The projection TV shuts down, check the cooling fan. Contact your service center.

Connection Options

- This is the back panel of models Z52DC2D series TVs.

Back Connection Panel

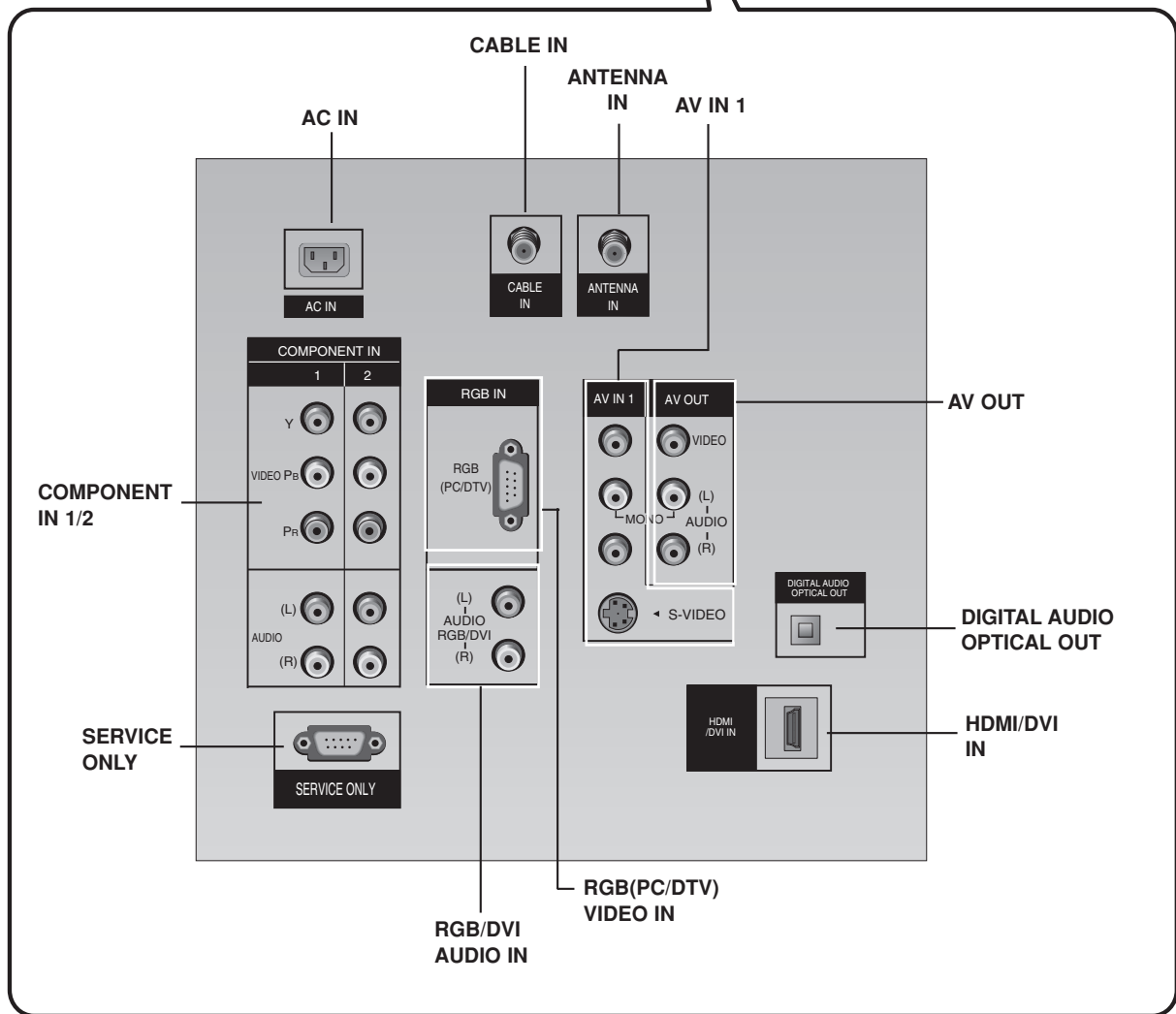
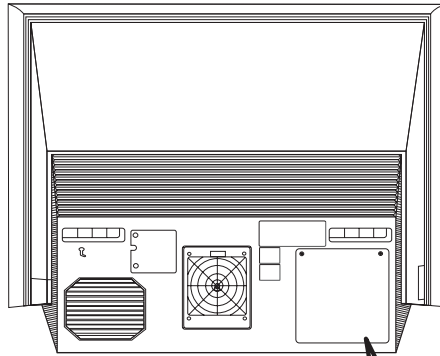

Front Connection Panel

There are four jacks on the left side on your projection TV that make connecting Audio/Video devices like video games and camcorders very simple.

The jacks are like those found on the back jack connection panel. This means that most equipment that connects to those types of jacks on the rear jackpack, may be connected to the front connection panel.

To use the side jacks as the signal source, select them using Main Input menu as described on page 25. They will be named "AV 2" in the Main Input menu.



If you input both AV 2 and S-Video, only the S-Video will work.



If you're connecting a video game device, make sure to change the picture settings with the EZ Picture option in the Video menu (see page 24).

Z56DC1D, Z62DC1D

Z52DC2D

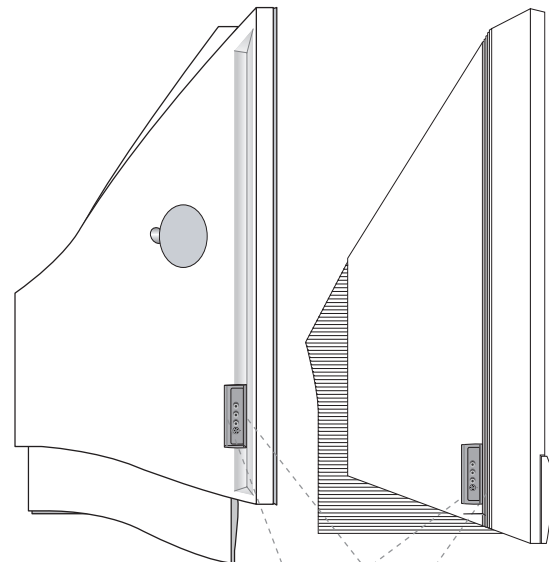

LEFT/RIGHT AUDIO

Used for stereo sound from various types of equipment.

VIDEO

Connects the video signals from any piece of equipment.

S-VIDEO

A connection available on some very high-end equipment that provides better picture quality than video input.

AV IN 2 Panel

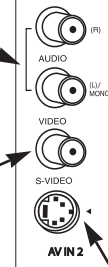

Mini glossary

A/V CABLES Audio/Video cables. Three cable connector—Right audio (red), Left audio (white), and Video (yellow). A/V cables are used for stereo playback of videocassettes and for higher quality picture and sound from other A/V devices.

A/V DEVICE Any device that produces video or sound (VCR, DVD, cable box, or television).

Remote Control Key Functions

- When using the Remote Control, aim it at the remote control sensor on the TV.

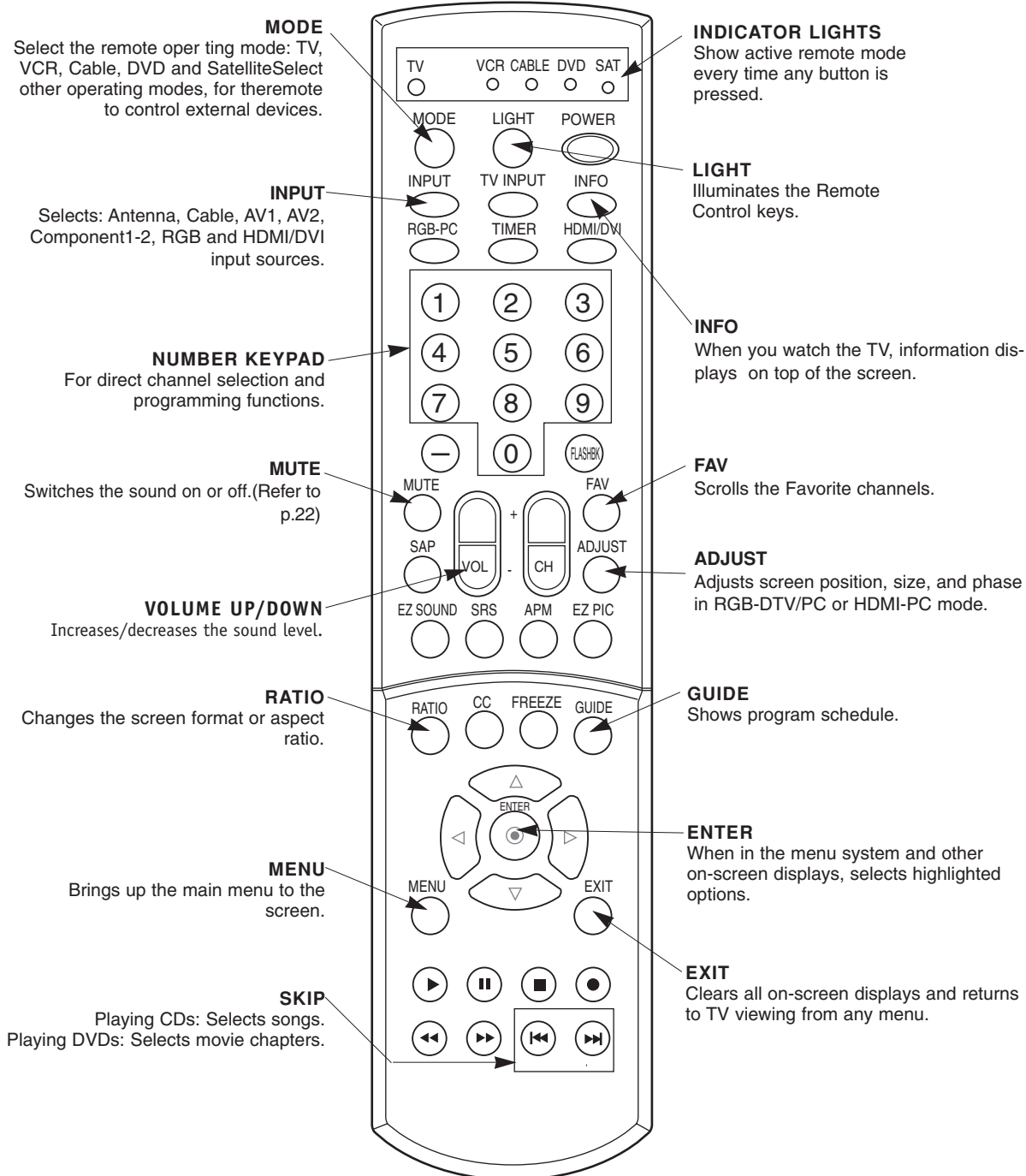

Remote Control Key Functions

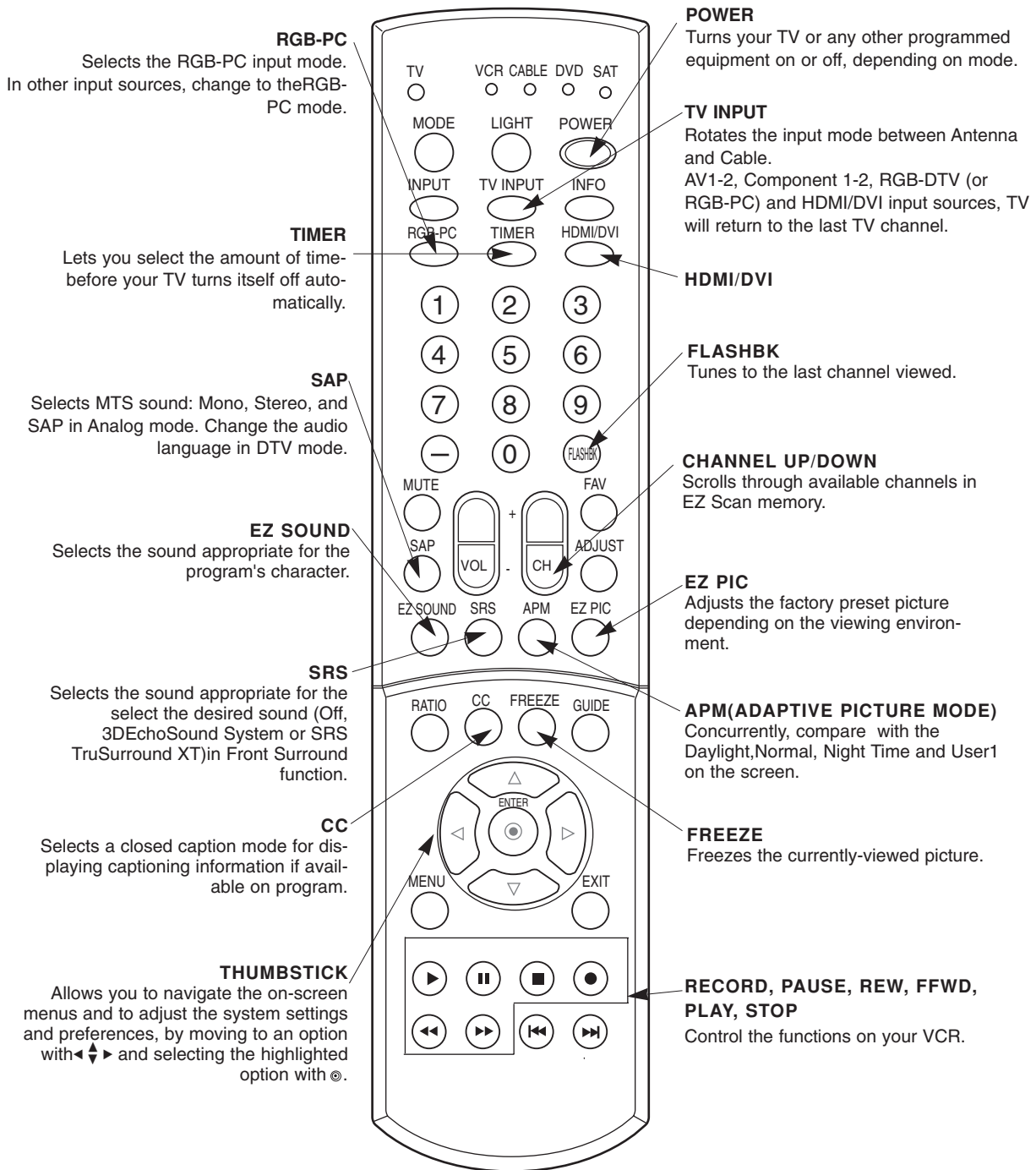

Installing Batteries

- Open the battery compartment cover on the back side and install the batteries matching correct polarity (+ with +, - with -).
- Install two 1.5V AA batteries. Don't mix old or used batteries with new ones. Close cover.

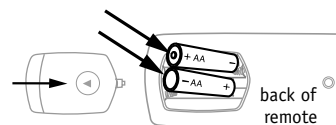

External Equipment Connections

1. Analog and Digital TV signals provided on antenna

- Wall Antenna Socket or Outdoor Antenna without a Cable Box Connections
- For optimum picture quality, adjust antenna direction if needed.

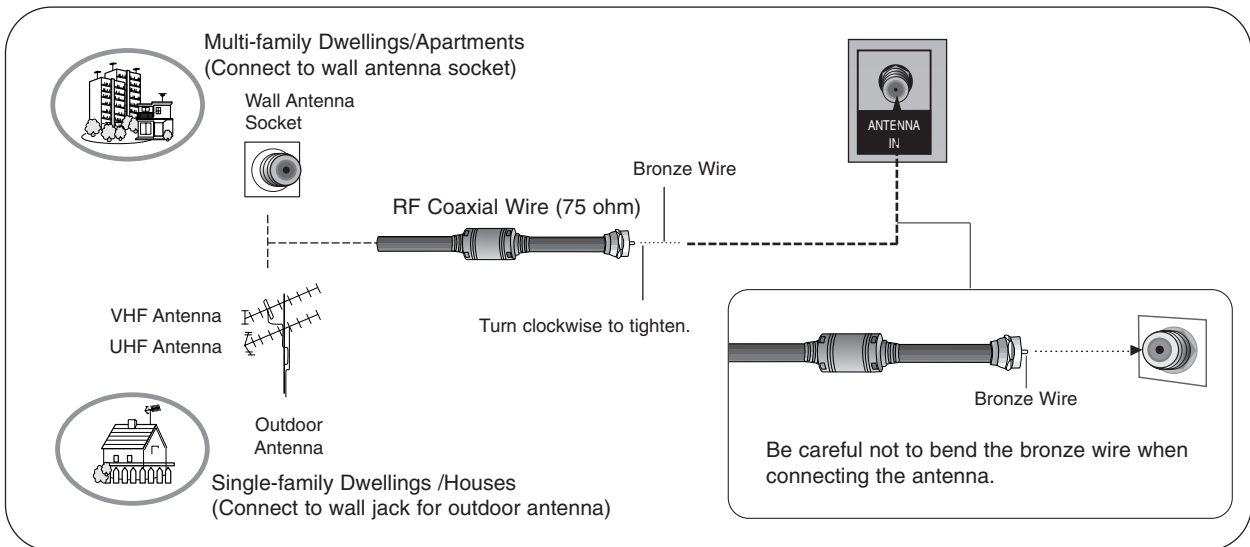

2. Analog and Digital TV signals provided on cable

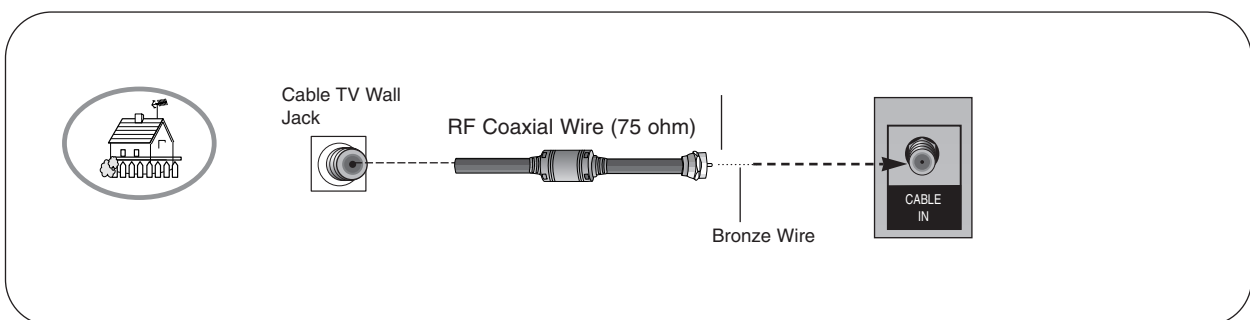

3. Analog and Digital TV signals provided on cable and antenna

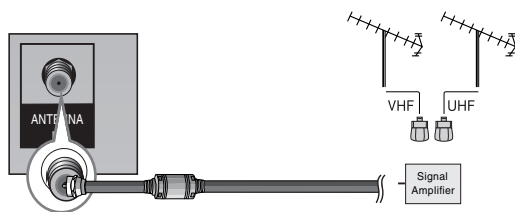
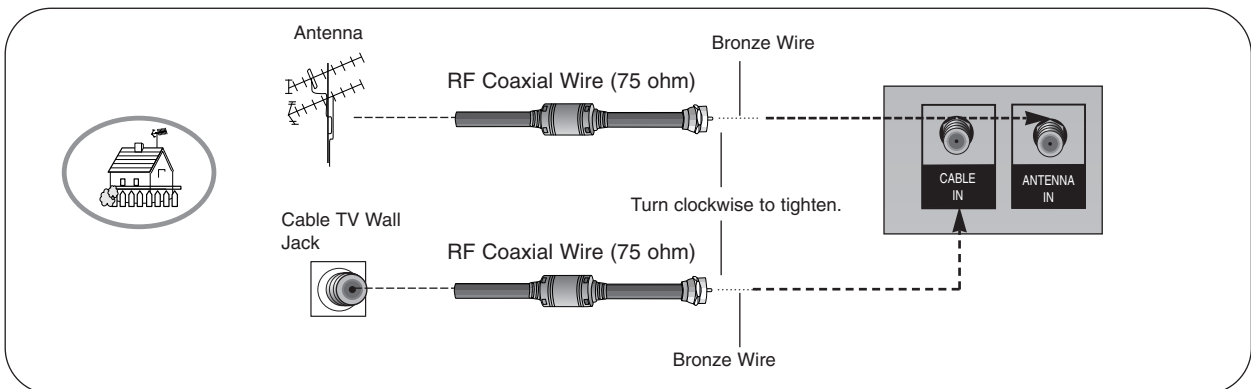

- To improve the picture quality in a poor signal area, please purchase a signal amplifier and install properly.
- If the antenna needs to be split for two TV's, install a "2-Way Signal Splitter" in the connections.
- If the antenna is not installed properly, contact your dealer for assistance.

Note: The TV will let you know when the TV(analog antenna), DTV(digital antenna), CATV(analog cable) and CADTV(digital cable) channel scans are complete.

VCR Setup

Connection Option 1

Set VCR output switch to channel 3 or 4 and then tune the TV to the same channel number.

Connection Option 2

1. Connect the audio and video cables from the VCR's output jacks to the TV input jacks, as shown in the figure. When connecting the TV to VCR, match the jack colors (Video = yellow, Audio Left = white, and Audio Right = red). If you connect an S-VIDEO output from VCR to the S-VIDEO input, the picture quality is improved; compared to connecting only the Video input.
2. Insert a video tape into the VCR and press PLAY on the VCR. (Refer to the VCR owner's manual.)
3. Select the input source with using the **INPUT** button on the remote control. Note that this TV finds the connected input sources automatically for AV 1-2 and Component 1-2.



Do not connect to both AV1-2 and S-Video at the same time. In the event that you connect both AV and the S-Video cables, only the S-Video will work.

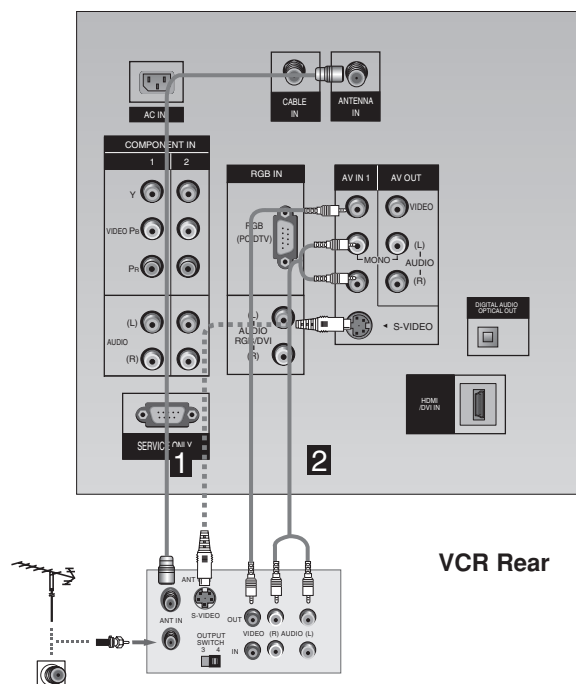

External A/V Source Setup

How to connect

Connect the audio and video cables from the external equipment's output jacks to the TV input jacks, as shown in the figure.

When connecting the TV to external equipment, match the jack colors (Video = yellow, Audio Left = white, and Audio Right = red).

How to use

1. Select the input source by using the INPUT button on the Remote Control. Note that this TV finds the connected input sources automatically for AV 1-2 and Component 1-2. It is presumed that RGB and HDMI/DVI sources are connected.
2. Operate the corresponding external equipment.

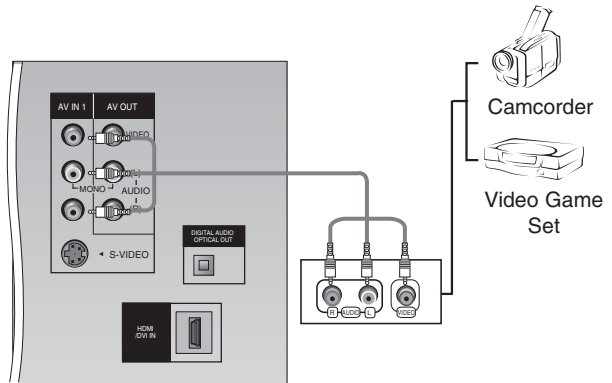

DVD Setup

How to connect

1. Connect the DVD video outputs (Y, P_B, P_R) to the COMPONENT (Y, P_B, P_R) INPUT jacks on the TV and connect the DVD audio outputs to the AUDIO INPUT jacks on the TV, as shown in the figure.
2. If your DVD only has an S-Video output jack, connect this to the S-VIDEO input on the TV and connect the DVD audio outputs to the AUDIO INPUT jacks on the TV, as shown in the figure.

Note: If your DVD player does not have component video output, use S-Video.

How to use

1. Turn on the DVD player, insert a DVD.
2. Use the **INPUT** button on the remote control to select **Component 1** or **Component 2**. (If connected to S-VIDEO, select the **AV1** or **AV2** external input source.)
3. Refer to the DVD player's manual for operating instructions.

• Component Input ports

To get better picture quality, connect a DVD player to the component input ports as shown below.

Component ports on the TV	Y	P _B	P _R
Video output ports on DVD player	Y	P _B	P _R
	Y	B-Y	R-Y
	Y	Cb	Cr
	Y	P _B	P _R

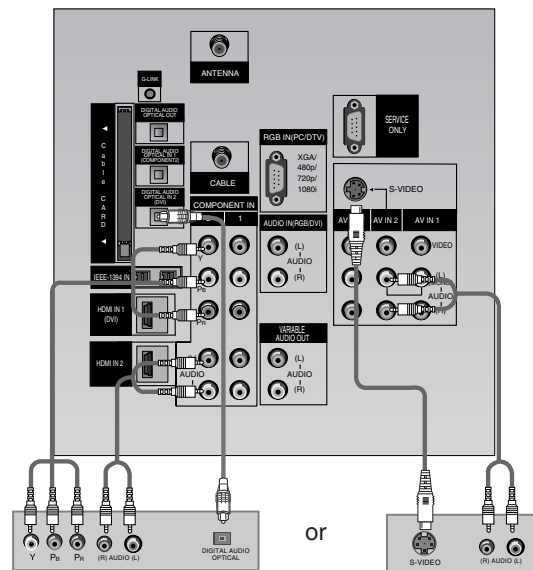

DVD

HDSTB Setup

- This TV can receive Digital Over-the-air/Cable signals without an external digital set-top box. However, if you do receive Digital signals from a digital set-top box or other digital external device, refer to the figure as shown below.
- This TV supports HDCP (High-bandwidth Digital Contents Protection) protocol for Digital Contents (480p,720p,1080i).

How to connect

Use the TV's COMPONENT (Y, PB, PR) INPUT, RGB, HDMI/DVI jack for video connections, depending on your set-top box connector. Then, make the corresponding audio connections.

Note: *HDMI(High Definition Multimedia Interface): Input that accepts uncompressed digital signal and multi channel digital audio signal.*

How to use

1. Turn on the digital set-top box. (Refer to the owner's manual for the digital set-top box.)
2. Use **INPUT** on the Remote Control to select **Component 1**, **Component 2**, **RGB-DTV** or **HDMI/DVI** source.

Signal	Component 1/2	RGB-DTV,HDMI/DVI
480i	Yes	No
480p	Yes	Yes
720p	Yes	Yes
1080i	Yes	Yes

AV Out Setup

The TV has a special signal output capability which allows you to hook up a second TV or monitor.

Connect the second TV or monitor to the TV's AV OUT. See the Operating Manual of the second TV or monitor for further details regarding that device's input settings.

Note

- *Component, RGB-PC/RGB-DTV, HDMI/DVI, DTV input sources cannot be used for AV out.*

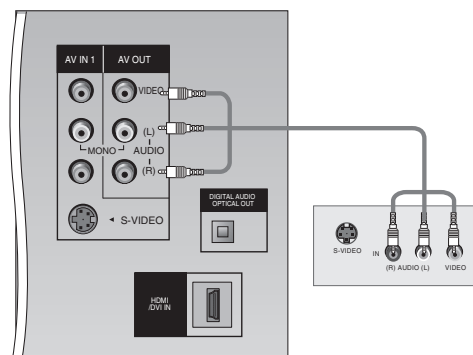

Digital Audio Output

Send the TV's audio to external audio equipment (stereo system) via the Digital Audio Output (Optical) port.

How to connect

1. Connect one end of an optical cable to the TV Digital Audio (Optical) Out port.
2. Connect the other end of the optical cable to the digital audio (optical) input on the audio equipment.
3. Set the "**TV Speaker** option - **Off**" in the AUDIO menu. Refer to page 33.
See the external audio equipment instruction manual for operation.



Caution: Do not look into the optical output port. Looking at the laser beam may damage your vision.

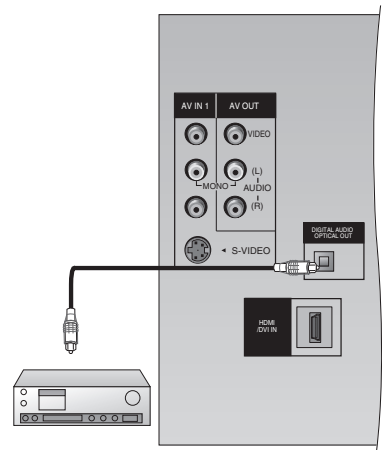

PC Setup

- This TV provides Plug and Play capability, meaning that the PC adjusts automatically to the TV's settings.
- The TV perceives 640x480, 60Hz as DTV 480p based on the PC graphic card, change the screen scanning rate for the graphic card accordingly.

When supporting RGB

How to connect

1. Connect the PC to RGB INPUT port of this TV with a RGB cable.
2. If the PC(or the sound card of the PC) has an analog audio out-put connector, connect the PC's audio output to AUDIO INPUT port located on the right side of RGB INPUT port.

How to use

1. To get the best picture quality, adjust the PC graphics card to 1024x768, 60 Hz.
2. Select **RGB-PC** input source in main input option of SETUP menu.

Once you select **RGB-PC** in main input option of SETUP menu, **INPUT** button is also available for this purpose.

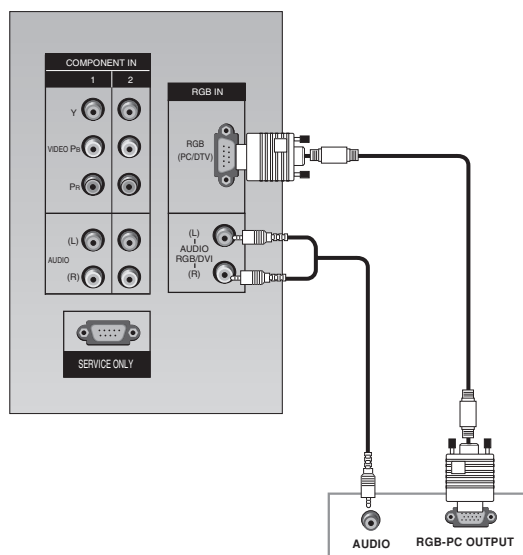

When supporting DVI

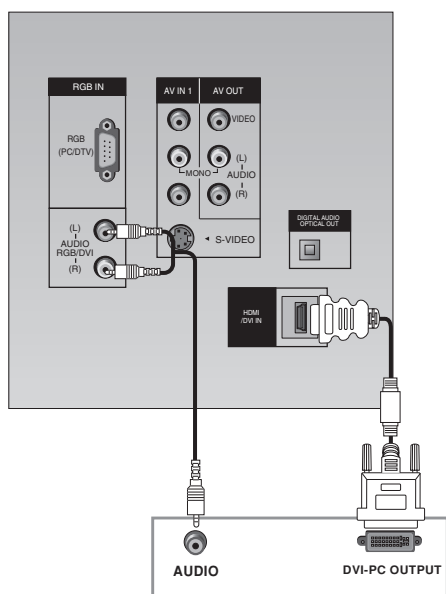

How to connect

1. Connect the PC to HDMI/DVI port of this TV with an HDMI-to-DVI cable(not supplied with this product).
2. If the PC(or the sound card of the PC) has an analog audio output connector, connect the PC's audio output to AUDIO INPUT port located on the right side of RGB INPUT port.

How To Use

1. To get the best picture quality, adjust the PC graphics card to 1024x768, 60Hz.
2. Select HDMI/DVI input source in main input option of SETUP menu.

INPUT button is also available for this purpose.



- Check the image on your TV. There may be noise associated with the resolution, vertical pattern, contrast or brightness in PC mode. If noise is present, change the PC output to another resolution, change the refresh rate to another rate, adjust Phase Calibration using the **ADJUST** button or adjust the brightness and contrast on the VIDEO menu until the picture is clear. If the refresh rate of the PC graphic card can not be changed, change the PC graphic card or consult the manufacturer of the PC graphic card.



Notes:

- Depending on the graphics card, DOS mode may not work if a HDMI1 to DVI Cable is in use.
- When Source Devices connected with HDMI/DVI Input, output PC Resolution(VGA, SVGA, XGA), Position and Size may not fit to Screen. As shown the picture below, press the ADJUST button to adjust the screen Position of TV SET and contact an PC graphics card service center.
- When Source Devices connected with HDMI/DVI Input, output TV SET Resolution(480p, 720p, 1080i) and TV SET Display fit EIA/CEA-861-B Specification to Screen.
If not, refer to the Manual of HDMI/DVI Source Devices or contact your service center.

- In case HDMI/DVI Source Devices is not connected Cable or poor cable connection, "No signal" OSD display in HDMI/DVI Input. In case that Video Resolution is not supported TV SET output in HDMI/DVI Source Devices, "Invalid Format" OSD display. Refer to the Manual of HDMI/DVI Source Devices or contact your service center.

Monitor Display Specifications (RGB-PC or HDMI/DVI Mode)

Resolution	Horizontal Frequency(KHz)	Vertical Frequency(Hz)
640x350	31.468	70.09
640x480	31.469	59.94
	37.861	72.80
800x600	37.500	75.00
	35.156	56.25
	37.879	60.31
1024x768	48.077	72.18
	46.875	75.00
	48.363	60.00
	56.476	70.06
	60.023	75.02

← RGB-PC Mode Only

Screen Setup for PC mode

Operation

- When RGB connect to PC input and select the RGB-PC in Main Input, this function is used.
- In RGB-PC mode, POSITION, SIZE, PHASE, RESET is available.
- In RGB-DTV mode, SIZE, PHASE is not available.
- In HDMI/DVI mode, POSITION, SIZE, RESET is available (When PC format is inputted) or any function is not available (When DTV format is inputted).

Adjustment for screen Position, Size, Phase, Reset

- After connecting RGB-PC or HDMI/DVI to PC input and checking the screen quality.
 - Display PC Adjust Menu using **ADJUST** button.
 - Position : Adjust the screen position. After displaying the Adjust, select the screen position.
 - Size : Adjust the screen size.
 - Phase : Adjust the phase of Pixel clock.
 - Reset : Initializing Size, Position, Phase adjustment .

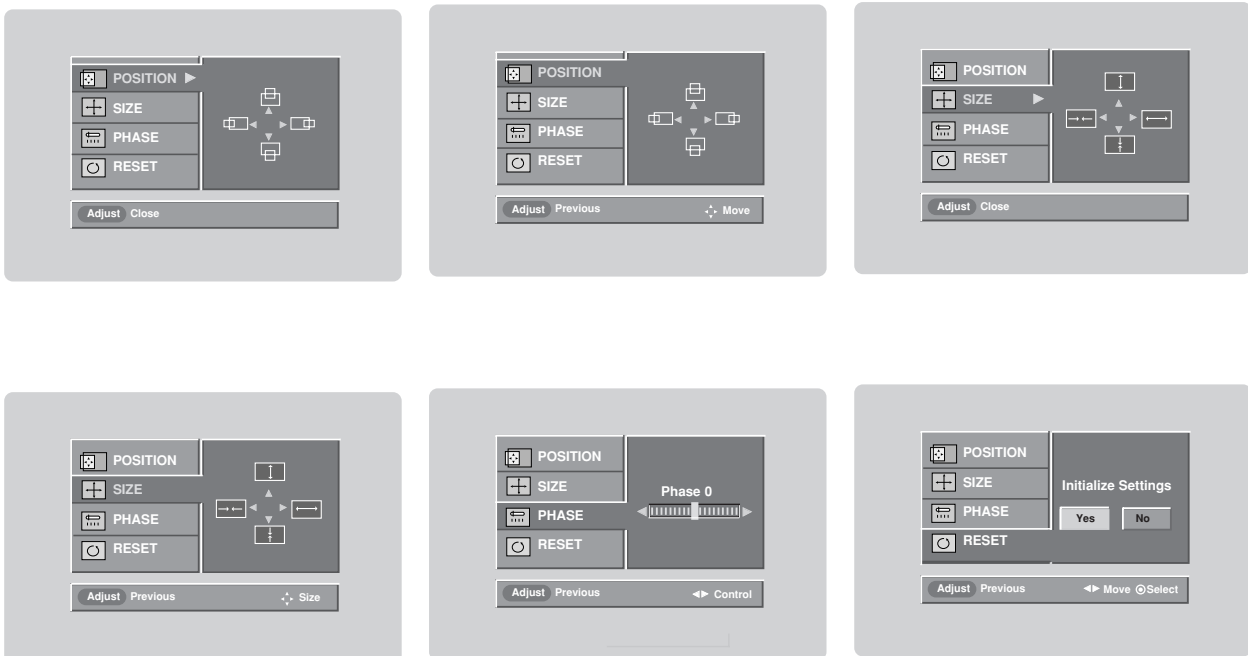

Operation

Turning the TV On

* In this manual, the OSD (On Screen Display) may be different from your TV's because it is just an example to help you with the TV operation.

Turning on the TV just after installation

1. Connect power cord correctly. At this moment, the TV is switched to standby mode.
2. Press the **POWER** or **CH** (▲ / ▼) buttons on the TV front panel or press the **POWER, INPUT, TV INPUT, CH (+ / -)** or **Number (0 ~ 9)** buttons on the Remote Control to turn the TV on.

Turning on the TV (power cord is still connected)

1. **If the TV is off without indicators on the TV**
 - Check the power cable.
2. **If the TV was turned off with the remote control and the POWER button on the TV**
 - Press the **POWER** button on the TV or press the **POWER, INPUT, TV INPUT, CH (+ / -)** or **Number (0 ~ 9)** button on the Remote Control to turn the TV on.

Notes: If you intend to be away on vacation, disconnect the power plug from the wall power outlet.

TV Setup

On-screen Menus Language Selection

- The menus can be shown on the screen in the selected language. First select your language.

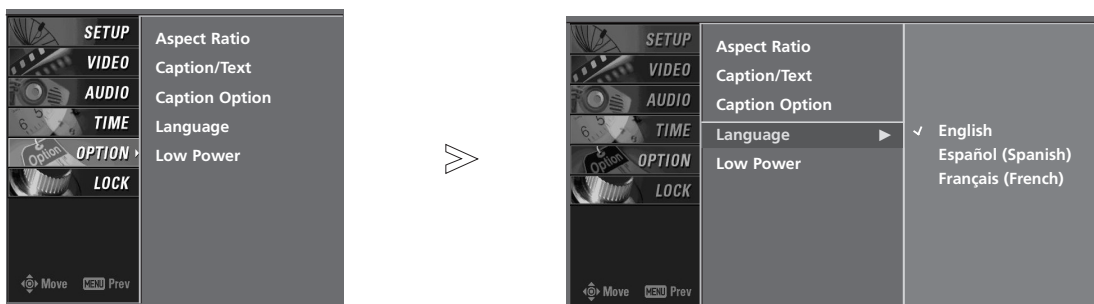

1. Press the **MENU** button and then use **▲** / **▼** button to select the **OPTION** menu.
2. Press the **▶** button and then use **▲** / **▼** button to select **Language**.
3. Press the **▶** button and then use **▲** / **▼** button to select your desired language.
From this point on, the on-screen menus will be shown in the selected language.
4. Press **EXIT** button to return to TV viewing or press **MENU** button to return to the previous menu.

Channel Selection

Press the **CH (+ / -)** or **NUMBER** buttons to select a channel number.

Note: When you selects the Scramble channel and then moves, the channel is automatically deleted.
To watch the Scramble channel, you must buy the separate cable box and apply for the subscription to the cable broadcasting station.

Volume Adjustment

1. Press the **VOL (+ / -)** button to adjust the volume.
2. If you want to switch the sound off, press the **MUTE** button.
3. You can cancel this function by pressing the **MUTE** or **VOL (+ / -)** button.

Setup Menu Options

EZ Scan (Channel Search)

- Automatically finds all available channels through antenna or cable inputs, and stores them in memory on the channel list.
- Run EZ Scan again after any Antenna/Cable connection changes.

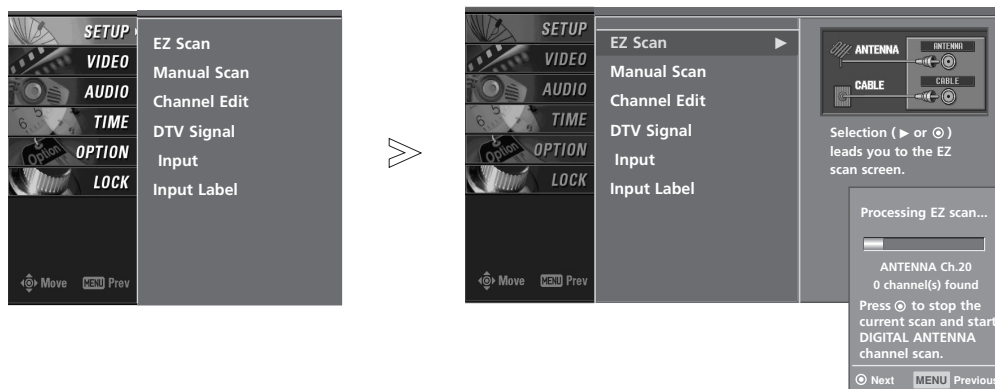

1. Press the **MENU** button and then use ▲ / ▼ button to select the **SETUP** menu.
2. Press the ► button and then use ▲ / ▼ button to select **EZ Scan**.
3. Press the ► button or **ENTER** button to begin the channel search.
Allow EZ Scan to complete the channel search cycle for TV, DTV, CATV, and CADTV.

Manual Scan

- A password is required to gain access to Manual Scan menu if the Lock System is turned on.



1. Press the **MENU** button and then use ▲ / ▼ button to select the **SETUP** menu.
2. Press the ► button and then use ▲ / ▼ button to select **Manual Scan**.
3. Press the ► button and then use ▲ / ▼ button to select TV/CADTV/CATV/DTV.
4. Press the ► button and then use ▲ / ▼ button to select channel number you want to add or delete.
5. Press the **ENTER** button to add or delete for the channel number.
6. Press **EXIT** button to return to TV viewing or press **MENU** button to return to the previous menu.

Channel Edit

Create two different types of channel lists in memory: "Custom List" and "Favorite List" from the default channel list created from the EZ Scan channel search.

A Custom List can be created by toggling each channel on or off with **ENTER** button. The channels in the Custom List are displayed in black color, and the channels deleted from the Custom List are displayed in gray color. Once a channel is highlighted you can add or delete the channel by referring to the small window at the top-left corner of the screen. You can create your own Favorite List.

Use the **FAV** button on the remote control when a channel is highlighted and then you can add or delete the channel to/from the Favorite List.

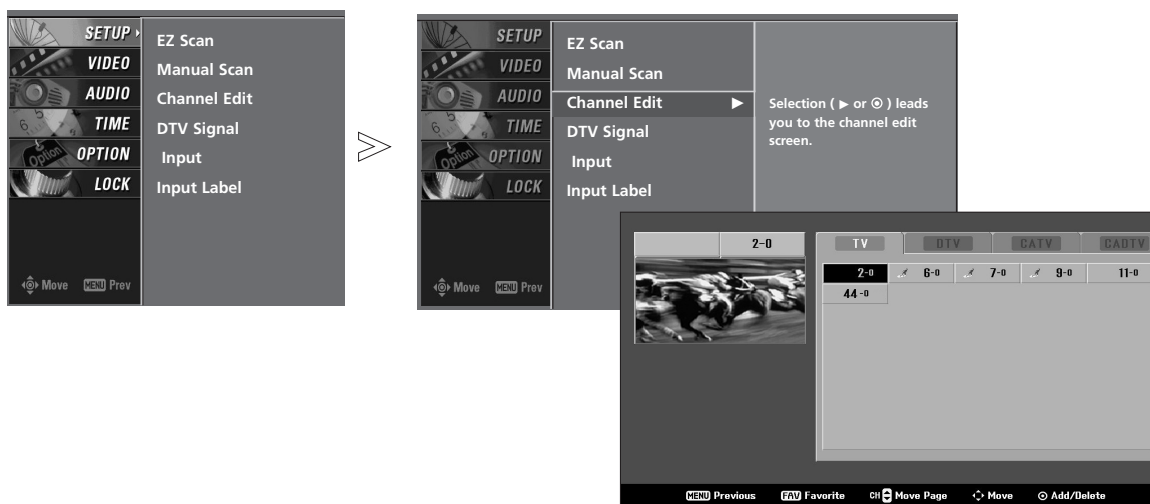

1. Press the **MENU** button and then use **▲ / ▼** button to select the **SETUP** menu.
2. Press the **▶** button and then use **▲ / ▼** button to select **Channel Edit**.
3. Press the **▶** button. You will now see a screen filled with channel numbers and a preview picture.
4. Use **▲ / ▼ / ◀ / ▶** button to select a channel and then use the **ENTER** button to add or delete it. Press **FAV** button to add the channel to the Favorite List.
5. Press **EXIT** button to return to TV viewing or press **MENU** button to return to the previous menu.

Note: When you selects the Scramble channel and then moves, the channel is automatically deleted.

To watch the Scramble channel, you must buy the separate cable box and apply for the subscription to the cable broadcasting station.

DTV Signal

This feature displays the DTV signal levels being received and indicates whether you need to adjust your antenna or digital cable input. The higher the signal strength, the less likely you are to experience picture degradation.

DTV Signal: This function is only available when the input signal is DTV or CADTV.

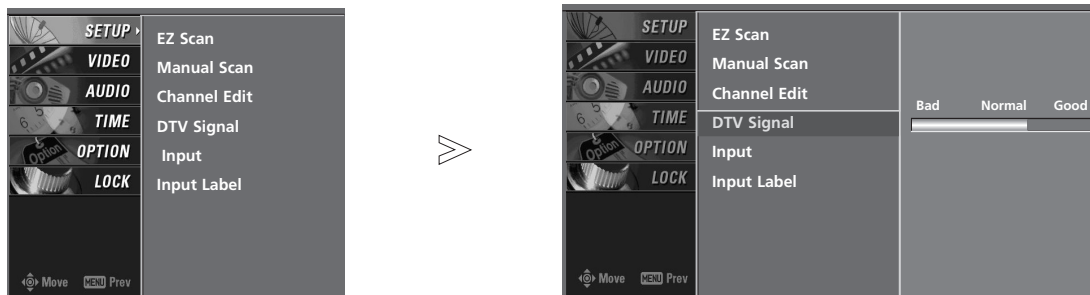

1. Press the **MENU** button and then use **▲ / ▼** button to select the **SETUP** menu.
2. Press the **▶** button and then use **▲ / ▼** button to select **DTV Signal**.
3. View the on-screen signal strength monitor to see the quality of the signal being received.
4. Press **EXIT** button to return to TV viewing or press **MENU** button to return to the previous menu.

Input Source Selection

Changes the picture source so you can watch your off-air TV, cable TV, VCR, DVD, or any other devices that are connected to your TV.



1. Press the **MENU** button and then use **▲** / **▼** button to select the **SETUP** menu.
2. Press the **▶** button and then use **▲** / **▼** button to select **Input**.
3. Press the **▶** button and then use **▲** / **▼** button to select the source: Antenna, Cable, AV1, AV2, Component1, Component2, RGB-DTV (or RGB-PC) or HDMI/DVI.
5. Press **EXIT** button to return to TV viewing or press **MENU** button to return to the previous menu.

Input Label

Sets a label to each input source which is in use when you press **INPUT** button.



1. Press the **MENU** button and then use **▲** / **▼** button to select the **SETUP** menu.
2. Press the **▶** button and then use **▲** / **▼** button to select **Input Label**.
3. Press the **▶** button and then use **▲** / **▼** button to select the source: AV1, AV2, Component1, Component2, RGB or HDMI/DVI.
4. Press **EXIT** button to return to TV viewing or press **MENU** button to return to the previous menu.

Video Menu Options

Auto Picture Control (EZ Picture)

EZ Picture adjusts the TV for the best picture appearance. Select the preset value in the EZ Picture menu based on the program category.

Daylight, Normal, Night Time settings are preset for optimum picture quality at the factory and are not adjustable. In the **User 1**, and **User 2** modes only, user can directly adjust the contrast, brightness, color, sharpness, tint.

1. Press the **EZ Video** button repeatedly to select the picture appearance setup option as shown below:
 - Daylight, Normal, Night Time, User 1** and **User 2**(your own settings).
 - You can also use the **VIDEO** menu to adjust **EZ Picture**.
2. Press the **EXIT** button to save and return to TV viewing .

Audio Language

Allows you to select your preferred picture mode after comparing the four different picture (Daylight , Normal , Night Time , User 1 and User 2) settings.

1. Press the **APM** button at once.As shown below,the screen is divided to 4-split.
2. Use the **▲ / ▼ / ◀ / ▶** button to navigate 4 EZ Pictures.
By pressing the **ENTER** button,you can select the desired mode.



Note: While operating the 4-split, any button except **APM, ENTER, EXIT, VOLUME ▲ or ▼ , MUTE** or **▲ / ▼ / ◀ / ▶** button on the remote control are not usable.

Color Temperature Control

Choose one of three automatic color adjustments. Set to warm to enhance hotter colors such as red, or set to cool to see less intense colors with more blue.



1. Press the **MENU** button and then use **▲** / **▼** button to select the **VIDEO** menu.
2. Press the **▶** button and then use **▲** / **▼** button to select **Color Temperature** .
3. Press the **▶** button and then use **▲** / **▼** button to select either **Cool**, **Medium**, **Warm** or **User** .
4. Press **EXIT** button to return to TV viewing or press **MENU** button to return to the previous menu.

Audio Menu Options

Manual Color Temperature Control

You can also adjust the detailed settings(Red, Green, Blue) by selecting the **User** menu.

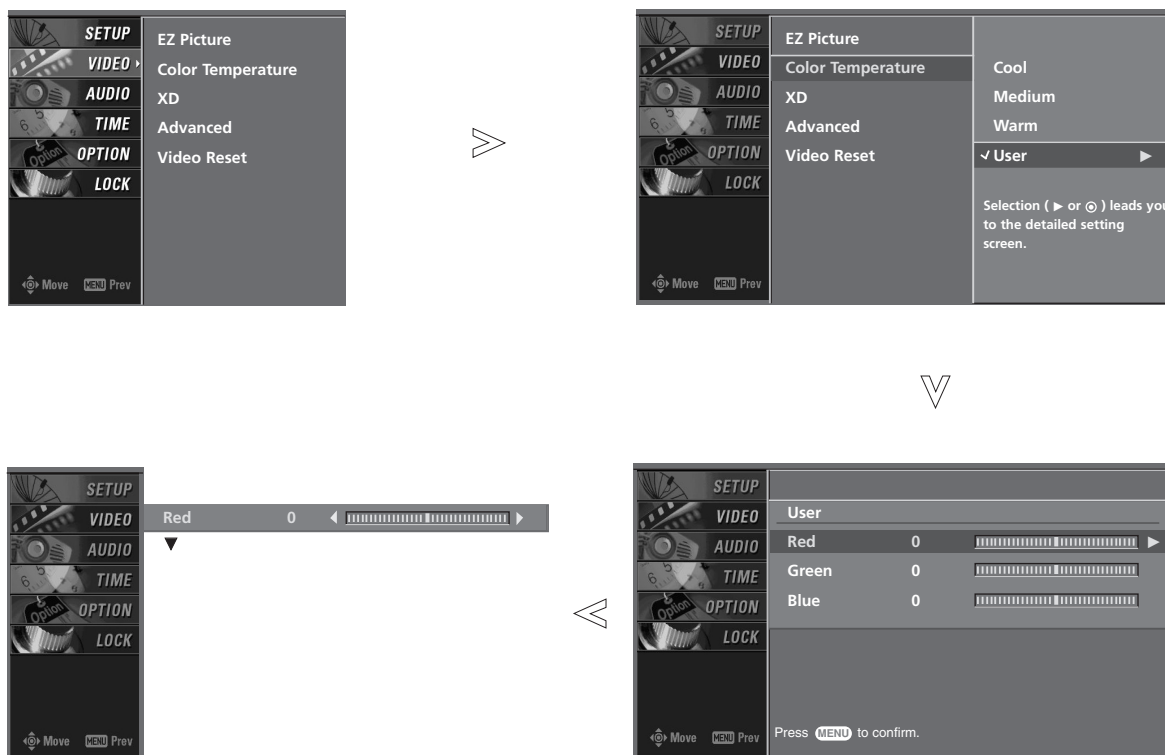

1. Press the **MENU** button and then use **▲** / **▼** button to select the **VIDEO** menu.
2. Press the **▶** button and then use **▲** / **▼** button to select **Color Temperature** .
3. Press the **▶** button and then use **▲** / **▼** button to select **User** .
4. Press the **▶** button and then use **▲** / **▼** button to select **Red, Green** or **Blue** .
5. Press the **▶** button and then use **◀** / **▶** button to make appropriate adjustments.
 - The adjustment range of **Red, Green** or **Blue** is -20~ +20.
6. Press **EXIT** button to return to TV viewing or press **MENU** button to return to the previous menu.

XD

XD is LG Electronic's unique picture improving technology to display a real HD source through an advanced digital signal processing algorithm.

When selecting EZ Picture options (Daylight, Normal and Night time), XD is automatically change to Auto.

When selecting EZ Picture options (User 1 and User 2), you can choose the Auto / Manual and when selecting Manual, you can adjust the XD Contrast, XD color and XD Noise.



1. Press the **MENU** button and then use **▲ / ▼** button to select the **VIDEO** menu.
2. Press the **▶** button and then use **▲ / ▼** button to select **XD**.
3. Press the **▶** button and then use **▲ / ▼** button to select **Auto** or **Manual**.

* Selecting the Manual

1. Press the **▶** button and then use **◀ / ▶** button to select **XD Contrast**, **XD Color** or **XD Noise**.

XD Contrast :Optimizing the contrast automatically according to the brightness of the reflection.

XD Color :Adjusting the colors of the reflection automatically to reproduce as closely as possible to the natural colors.

XD Noise :Removing the noise up to the point where it does not damage the original picture.

2. Use the **▲ / ▼** button to make appropriate adjustments.

4. Press **EXIT** button to return to TV viewing or press **MENU** button to return to the previous menu.

Advanced-Cinema 3:2 Mode / Black Level

• Cinema 3:2 Mode

- Set up the TV for the best picture appearance for viewing movies.

When you operate Cinema (3:2 Pull-Down Mode or Cinema Correction Mode), the TV will adjust 24 fps video from movies to 30 fps video for display (This function is only available in Analog, AV1, AV2, Component 480i mode.)

• Black level

- Adjusting the contrast and the brightness of the screen using the black level of the screen. This feature operates only in HDMI/DVI or AV1, AV2 mode.

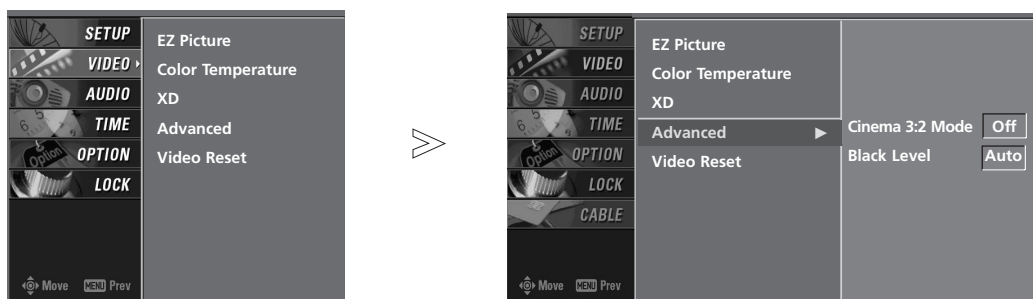

1. Press the **MENU** button and then use **▲ / ▼** button to select the **VIDEO** menu.
2. Press the **▶** button and then use **▲ / ▼** button to select **Advanced**.
3. Press the **▶** button and then use **▲ / ▼** button to select **Cinema 3:2 Mode** or **Black Level**.

* Selecting the **Cinema 3:2 Mode**

4. Press the **▶** button and then use **▲ / ▼** button to select **On** or **Off**.

* Selecting the **Black Level**

4. Press the **▶** button and then use **▲ / ▼** button to select **Auto**, **Low** or **High**.

Auto

Realizing the black level of the screen and set it to High or Low automatically.

Low

The reflection of the screen gets darker.

High

The reflection of the screen gets brighter.

4. Press **EXIT** button to return to TV viewing or press **MENU** button to return to the previous menu.

Video Reset

Use to quickly reset all the Video menu options to their original factory preset values.



1. Press the **MENU** button and then use **▲ / ▼** button to select the **VIDEO** menu.
2. Press the **▶** button and then use **▲ / ▼** button to select **Video Reset**.
3. Press the **▶** button to reset the Video menu options to original values.

Audio Menu Options

Audio Language

Other languages may be available if a digital signal is provided by the broadcasting station.



1. Press the **MENU** button and then use **▲** / **▼** button to select the **AUDIO** menu.
2. Press the **▶** button and then use **▲** / **▼** button to select **Audio Language**.
3. Press the **▶** button and then use **▲** / **▼** button to select: English, Spanish, or French.
4. Press **EXIT** button to return to TV viewing or press **MENU** button to return to the previous menu.

Auto Volume Leveler (EZ SoundRite)

Scans for changes in sound level during commercials, then adjusts the sound to match the specified audio level. SoundRite makes sure that the volume level remains consistent whether you are watching a commercial or a regular TV program.



1. Press the **MENU** button and then use **▲** / **▼** button to select the **AUDIO** menu.
2. Press the **▶** button and then use **▲** / **▼** button to select **EZ SoundRite**.
3. Press the **▶** button and then use **▲** / **▼** button to select **On** or **Off**.
4. Press **EXIT** button to return to TV viewing or press **MENU** button to return to the previous menu.

Auto Sound Control (EZ Sound)

EZ Sound lets you enjoy the best sound without any special adjustment because the TV sets the appropriate sound options based on the program content.

Normal, Stadium, News, Music and Theater are preset for good sound quality at the factory and are not adjustable.

1. Press the EZ Sound button repeatedly to select the appropriate sound setup as shown below :

Normal , **Stadium** , **News** , **Music** , **Theater** and **User** (your own settings) .

- You can also adjust **EZ Sound** in the **AUDIO** menu.

2. Press EXIT button to save and return to TV viewing.

Manual Sound Control (**EZ Sound** -**User** option)

Adjust the sound to suit your taste and room situations.

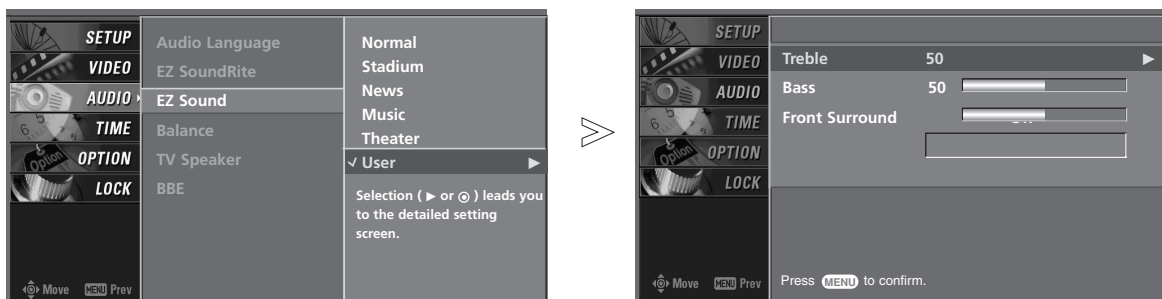

1. Press the **MENU** button and then use **▲** / **▼** button to select the **AUDIO** menu.
2. Press the **▶** button and then use **▲** / **▼** button to select **EZ Sound**.
3. Press the **▶** button and then use **▲** / **▼** button to select **User**.
4. Press the **▶** button and then use **▲** / **▼** button to select the desired sound option (**Treble**, **Bass** or **Front Surround**).
5. Press the **▶** button and then use **◀** / **▶** button to make appropriate adjustments.

* Selecting the Front Surround

Press the **▶** button and then use **◀** / **▶** button to select **Off**, **3D EchoSound System** or **SRS(Sound Retrieval System)TruSurround XT** .



6. Press **EXIT** button to return to TV viewing or press **MENU** button to return to the previous menu.

SRS TruSurround XT

Takes advantage of any multi-channel format without needing to add extra speakers or equipment. Dialog clarity, bass enrichment, and the addition of stereo audio enhancement produces an immersive sound experience from standard stereo material.

3D EchoSound System

Creates a stunning simulated stereo effect from any mono sound and a realistic three-dimensional sound with a very wide and deep sound stage.

Balance

Adjust the left/right sound of speaker to suit your taste and room situations.

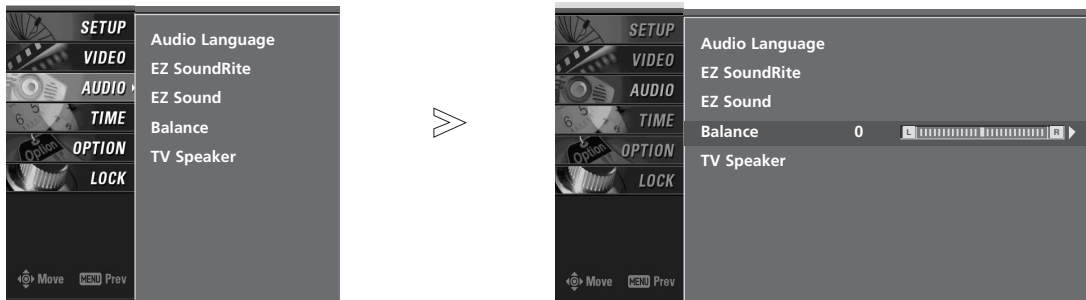

1. Press the **MENU** button and then use **▲** / **▼** button to select the **AUDIO** menu.
2. Press the **▶** button and then use **▲** / **▼** button to select **Balance**.
3. Press the **▶** button and then use **◀** / **▶** button to make appropriate adjustments.
4. Press **EXIT** button to return to TV viewing or press **MENU** button to return to the previous menu.

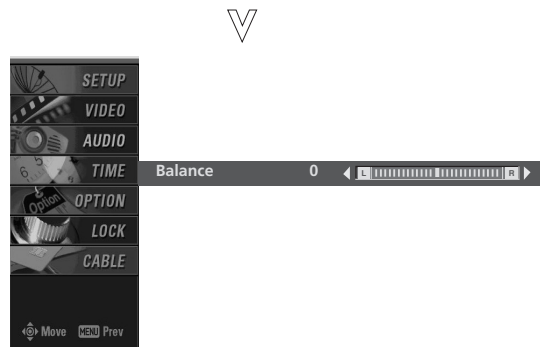

TV Speaker On/Off Setup

Turn TV speakers off if using external audio equipment. Feature turns the TV Speakers option On or Off.



1. Press the **MENU** button and then use **▲** / **▼** button to select the **AUDIO** menu.
2. Press the **▶** button and then use **▲** / **▼** button to select **TV Speaker**.
3. Press the **▶** button and then use **▲** / **▼** button to select **On** or **Off**.
4. Press **EXIT** button to return to TV viewing or press **MENU** button to return to the previous menu.

Time Menu Options

Auto Clock Setup

The time is set automatically from a digital channel signal.
The digital channel signal includes information for the current time provided by the broadcasting station.
Set the clock manually, if the current time is set incorrectly by the auto clock function through Digital Channel Service problem.

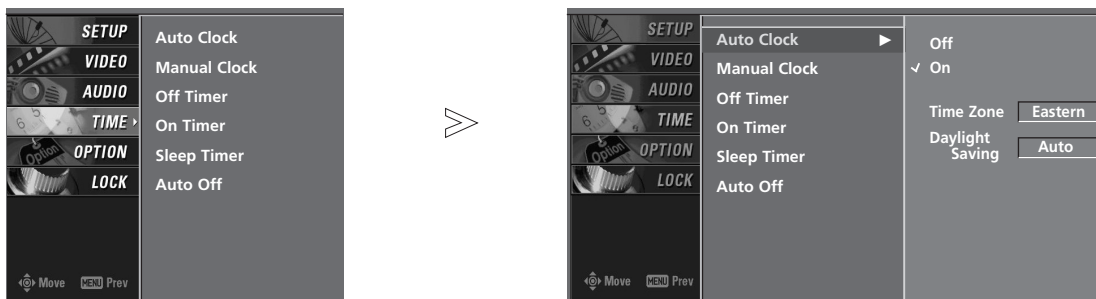

1. Press the **MENU** button and then use **▲ / ▼** button to select the **TIME** menu.
2. Press the **▶** button and then use **▲ / ▼** button to select **Auto Clock**.
3. Press the **▶** button and then use **▲ / ▼** button to select **On**.
4. Press the **▶** button and then use **▲ / ▼** button to select your viewing area time zone: **Eastern**, **Central**, **Mountain**, **Pacific**, **Alaska**, or **Hawaii**.
5. Press the **▶** button and then use **▲ / ▼** button to set Daylight Saving **Auto**, **Off** or **On**, depending on whether or not your viewing area observes Daylight Savings Time.
6. Press **EXIT** button to return to TV viewing or press **MENU** button to return to the previous menu.

Manual Clock Setup

If current time setting is wrong, reset the clock manually.

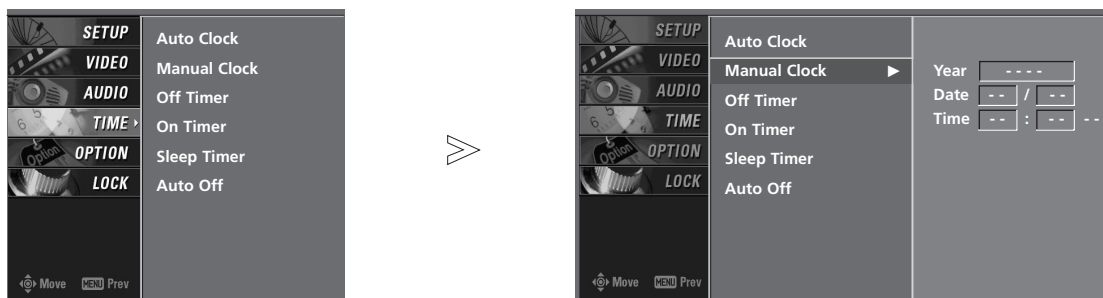

1. Press the **MENU** button and then use **▲ / ▼** button to select the **TIME** menu.
2. Press the **▶** button and then use **▲ / ▼** button to select **Manual Clock**.
3. Press the **▶** button and then use **◀ / ▶** button to select either the year, date, or time option. Once selected, use the **▲ / ▼** button to set the year, date, and time options.
4. Press **EXIT** button to return to TV viewing or press **MENU** button to return to the previous menu.

On/Off Timer Setup

Timer function operates only if current time has been set.

Off-Timer function overrides On-Timer function if they are both set to the same time.

The TV must be in standby mode for the On-Timer to work.

If you do not press any button within 2 hours after the TV turns on with the On Timer function, the TV will automatically revert to standby mode.



1. Press the **MENU** button and then use **▲ / ▼** button to select the **TIME** menu.
2. Press the **▶** button and then use **▲ / ▼** button to select **Off Timer** or **On Timer** .
3. Press the **▶** button and then use **▲ / ▼** button to select **On** .
 - To cancel **On / Off Timer** function, select **Off** .
4. Press the **▶** button and then use **▲ / ▼** button to set the hour.
5. Press the **▶** button and then use **▲ / ▼** button to set the minutes.
6. For only **On Timer** function
 - Press the **▶** button and then use **▲ / ▼** button to select the channel at turn-on.
 - Press the **▶** button and then use **▲ / ▼** button to set the sound level at turn-on.
7. Press **EXIT** button to return to TV viewing or press **MENU** button to return to the previous menu.

Sleep Timer

The Sleep Timer turns the TV off after a preset amount of time. Note that this setting is cleared when the TV is turned off.

- You can also set up the **Sleep Timer** in the **TIME** menu.

1. Press the **TIMER** button repeatedly to select the number of minutes. First the **Off** option appears on the screen, followed by the following sleep timer options: 10, 20, 30, 60, 90, 120, 180, and 240 minutes.
2. When the number of minutes you want is displayed on the screen, press the **ENTER** button. The timer begins to count down from the number of minutes selected.
3. To check the remaining minutes before the TV turns off, press the **TIMER** button once.
4. To cancel the Sleep Timer, press the **TIMER** button repeatedly to select **Off** .

Auto Off

If set to on and there is no input signal, the TV turns off automatically after 10 minutes.

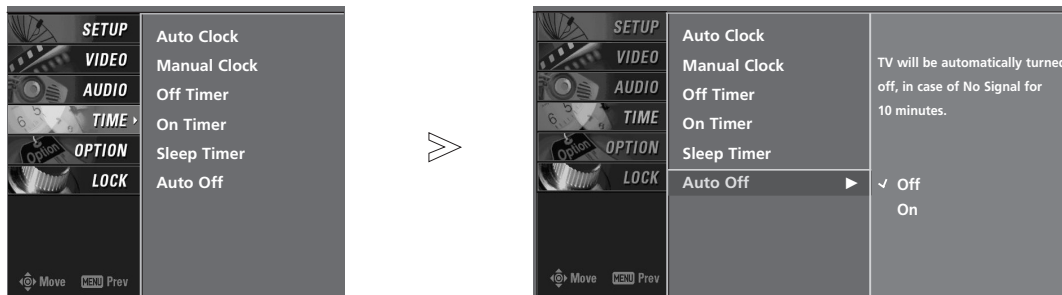

1. Press the **MENU** button and then use **▲ / ▼** button to select the **TIME** menu.
2. Press the **▶** button and then use **▲ / ▼** button to select **Auto Off**.
3. Press the **▶** button and then use **▲ / ▼** button to select **On** or **Off**.
4. Press **EXIT** button to return to TV viewing or press **MENU** button to return to the previous menu.

Option Menu Features

Aspect Ratio Control

This feature lets you choose the way an analog picture with a 4:3 aspect ratio is displayed on your TV. When you receive an analog picture with a 4:3 aspect ratio on your 16:9 TV, you need to specify the picture is to be displayed.

RGB-PC/DVI-PC input source use 4:3 or 16:9 aspect ratio.

1. Press the **RATIO** button repeatedly to select the desired picture format.

- You can also adjust the **Aspect Ratio** in the **OPTION** menu.

Set by program

Selects the proper picture proportion to match the source's image.

(4:3 → 4:3)

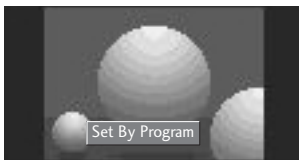

4:3

Choose 4:3 when you want to view a picture with an original 4:3 aspect ratio.



16:9

Adjust the picture horizontally, in a linear proportion to fill the entire screen.



Horizon

The screen size is, more enlarged at both sides, to create a spectacular view.

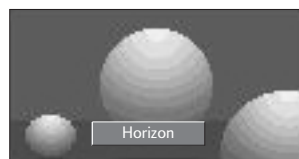

Zoom 1

Choose Zoom 1 when you want to view the picture without any alteration. However, the top and bottom portions of the picture will be cropped.

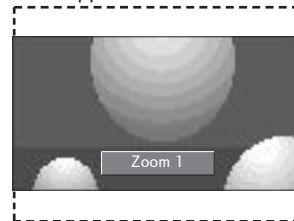

Zoom 2

Choose Zoom 2 when you want the picture to be altered, both vertically extended and cropped. The picture taking a halfway trade off between alteration and screen coverage.

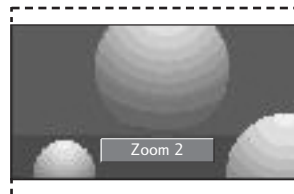

Cinema Zoom

Choose Cinema Zoom when you want to enlarge the picture in correct proportion. Note: When enlarging or reducing the picture, the image may become distorted.

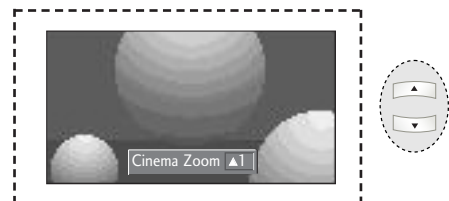

- The adjustment range is 1-16.

Caption/Text

Analog Broadcasting System Captions

Select a caption mode for displaying captioning information if provided on a program.

Analog caption displays information at any position on the screen usually the program's dialog.

Text displays information, usually at the bottom position and is used for a data service, generally not program related.

Caption/Text, if provided by the broadcaster, would be available for both digital and analog channels on the Antenna/Cable.

This TV is programmed to remember the caption/text mode it was last set to, when you turn the power off.

1. Use the **CC** button repeatedly to select Caption **Off**, **CC1**, **CC2**, **CC3**, **CC4**, **Text1**, **Text2**, **Text3**, or **Text4**.
2. Press **EXIT** button to save and return to TV viewing.
 - You can also use the **OPTION** menu to select **Caption/Text**.



1. Press the **MENU** button and then use **▲** / **▼** button to select the **OPTION** menu.
2. Press the **▶** button and then use **▲** / **▼** button to select **Caption/Text**.
3. Press the **▶** button and then use **▲** / **▼** button to select caption: **Off**, **CC1**, **CC2**, **CC3**, **CC4**, **Text1**, **Text2**, **Text3**, or **Text4**.

• CAPTION

The term for the words that scroll across the bottom of the TV screen; usually the audio portion of the program provided for the hearing impaired.

• TEXT

The term for the words that appear in a large black frame and almost cover the entire screen; usually messages provided by the broadcaster.

4. Press **EXIT** button to return to TV viewing or press **MENU** button to return to the previous menu.

Digital Broadcasting System Captions

Choose the language you want the DTV/CADTV Captions to appear in.

Languages can be chosen for digital sources only if they are included on the program.



1. Press the **MENU** button and then use **▲** / **▼** button to select the **OPTION** menu.
2. Press the **▶** button and then use **▲** / **▼** button to select **Caption/Text**.
3. Press the **▶** button and then use **▲** / **▼** button to select available caption languages: **English**, **Spanish**, or **French**, **Text4**.
4. Press **EXIT** button to return to TV viewing or press **MENU** button to return to the previous menu.

Caption Option

Customize the DTV/CADTV captions that appear on your screen.



1. Press the **MENU** button and then use **▲ / ▼** button to select the **OPTION** menu.
2. Press the **▶** button and then use **▲ / ▼** button to select **Caption Option**.
3. Press the **▶** button and then use **▲ / ▼** button to select **Custom**.
4. Use **▲ / ▼** button to customize the Style, Font, etc., to your preference. A preview icon is provided at the bottom of the screen, use it to see the caption language.

- **Size:** Set the size the words will appear in.
- **Font:** Select a typeface for the words.
- **Text Color:** Choose a color for the text.
- **Text Opacity:** Specify the opacity for the text color.
- **Bg (Background) Color:** Select a background color.
- **Bg (Background) Opacity:** Select the opacity for the background color.
- **Edge Type:** Select an edge type.
- **Edge Color:** Select a color for the edges.

5. Press **EXIT** button to return to TV viewing or press **MENU** button to return to the previous menu.

Low Power

Low power reduces the plasma display power consumption.

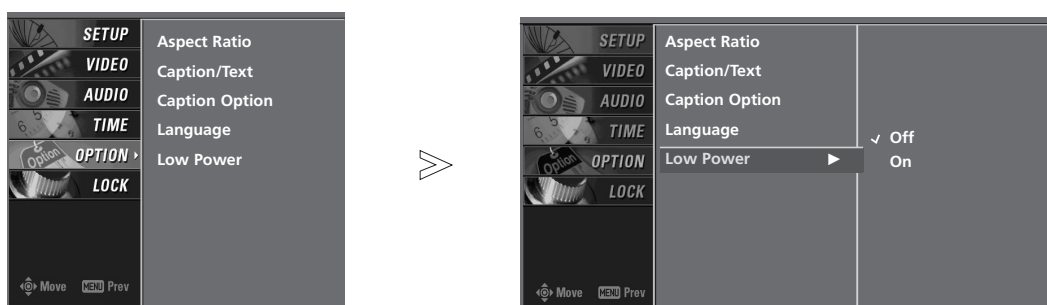

1. Press the **MENU** button and then use **▲ / ▼** button to select the **OPTION** menu.
2. Press the **▶** button and then use **▲ / ▼** button to select **Low Power**.
3. Press the **▶** button and then use **▲ / ▼** button to select **On** or **Off**.
 - When you select **On**, the screen darkens.
4. Press **EXIT** button to return to TV viewing or press **MENU** button to return to the previous menu.

Lock Menu Options

Parental Control can be used to block specific channels, ratings and other viewing sources.

The Parental Control Function (V-Chip) is used to block program viewing based on the ratings sent by the broadcasting station. The default setting is to allow all programs to be viewed. Viewing can be blocked by the type of program and by the categories chosen to be blocked. It is also possible to block all program viewing for a time period. To use this function, the following must be done :

1. Set ratings and categories to be blocked.
2. Specify a password
3. Enable the lock

V-Chip rating and categories

Rating guidelines are provided by broadcasting stations. Most television programs and television movies can be blocked by TV Rating and/or Individual Categories. Movies that have been shown at the theaters or direct-to-video movies use the Movie Rating System (MPAA) only.

Ratings for Movies previously shown in theaters:

Movie Ratings :

- Blocking Off (Permits all programs)
- G (General audience)
- PG (Parental guidance suggested)
- PG-13 (Parents strongly cautioned)
- R (Restricted)
- NC-17 (No one 17 and under admitted)
- X (Adult only)

If you set PG-13 : G and PG movies will be available, PG-13, R, NC-17 and X will be blocked.

Ratings for Television programs including made-for-TV movies :

- TV-G (General audience)
- TV-PG (Parental guidance suggested)
- TV-14 (Parents strongly cautioned)
- TV-MA (Mature audience only)
- TV-Y (All children)
- TV-Y7 (Children 7 years older)

TV Rating-Children:

- Age (applies to TV-Y, TV-Y7)
- Fantasy Violence (applies to TV-Y7)

TV Rating-General:

- Age (applies to TV-G, TV-PG, TV-14, TV-MA)
- Dialogue- sexual dialogue (applies to TV-PG, TV-14)
- Language- adult language (applies to TV-PG, TV-14, TV-MA)
- Sex- sexual situations (applies to TV-PG, TV-14, TV-MA)
- Violence (applies to TV-PG, TV-14, TV-MA)

Input Block

- AV1, 2, (On, Off)
- Component 1, 2 (On, Off)
- RGB or HDMI/DVI (On, Off)

Parental Lock Setup

Set up blocking schemes to block specific channels, ratings, and external viewing sources. A password is required to gain access to this menu.

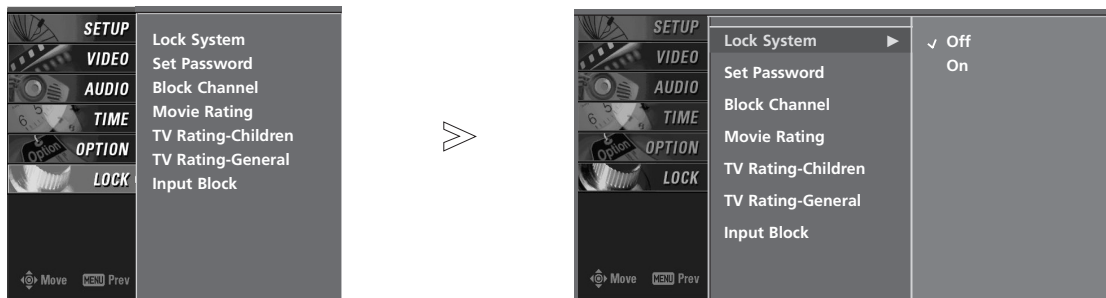

1. Press the **MENU** button and then use **▲ / ▼** button to select the **LOCK** menu. Then, press the **▶** button.
 - Enter the password as requested.
 - The TV is set up with the initial password "0-0-0-0".
2. Use the **▲ / ▼** button to choose from the following Lock Menu options. Once the option is selected, change the settings to your preference.
 - **Lock System:** Activates or disables the blocking scheme you set up previously.
 - **Set Password:** Change the password by inputting a new password twice.
 - **Block Channel:** Select a channel number that you wish to block.
 - **Movie Rating (MPPA):** Blocks movies according to the movie ratings limits specified, so children cannot view certain movies. You can set the ratings limit by blocking out all the movies with the ratings above a specified level. Keep in mind that the movie ratings limit only applies to movies shown on TV, not TV programs, such as soap operas.
 - **TV Rating-Children:** Prevents children from watching certain children's TV programs, according to the ratings limit set. The children rating does not apply to other TV programs. Unless you block certain TV programs intended for mature audiences in the TV Rating - sub menu, your children can view those programs.
 - **TV Rating-General:** Based on the ratings, blocks certain TV programs that you and your family do not want to view.
 - **Input block:** Enables you to select a source to block from the external source devices you have hooked up.
3. Press **EXIT** button to return to TV viewing or press **MENU** button to return to the previous menu.

Note: If you ever forget your password, key in '7', '7', '7', '7' on the remote control.

Split Zoom (DTV 720p, or 1080i mode only)

- Enlarges the picture with correct proportions.
- When enlarging the picture, the image may become distorted.

1. Press the **FREEZE** button in DTV 720p, or 1080i modes.
2. Use the **▲ / ▼ / ◀ / ▶** buttons to select the screen split zoom section.
3. To return to normal viewing, press the **FREEZE** button again.



EPG (Electronic Program Guide) (In DTV mode)

- This system has an Electronic Program Guide (EPG) to help you navigate through all the possible viewing options.
- The EPG supplies information such as program listings, start and end times for all available services.
- This function can be used only when the EPG information is broadcasted by broadcasting companies.
- The EPG displays the program description for next 3 days.
- This function is only supported in DTV mode.







1. Press the **GUIDE** button to switch on EPG.
2. Press the **▲ / ▼ / ◀ / ▶** button to select desired program, then press the **ENTER** button to display the selected program.
3. Press the **GUIDE** or **EXIT** button again to switch off EPG and return to TV viewing.

Remote Control Buttons	Function
▲ / ▼ / ◀ / ▶	Select the desired program
●	Change to the selected channel
◀◀ / ▶▶	Jump Page
◀◀ / ▶▶	Change the date
GUIDE/EXIT	Switch off EPG

Brief Info.

- Function :
- Show the present screen information.
 - On Watching with the upper Input signal, press the **INFO** button.
 - Press the **INFO** button or **EXIT** button to exit.

- A: Banner information
- B: Program title
- C: Day, Month, Year
- D: Program start time
- E: Program finish time
- F: Show the processing rate
- G: Present time
- H: Added information. Refer to the icon explanation.

	Screen Ratio of Input Signal 4:3
	Screen Ratio of Input Signal 16:9
480i	Resolution of Input Signal 720x480i
480p	Resolution of Input Signal 720x480p
720p	Resolution of Input Signal 1280x720p
1080i	Resolution of Input Signal 1920x1080i
	Multilingual : Input Signal have over two Audio information. Press the SAP button to select wanted Audio.
	Caption: Input Signal have over one Close service. Press the CC button to select wanted Closed caption.
	Input Signal has rating information . Refer to the <Lock Menu>. D (Dialogue), L (Language), S (Sex), V (Violence), FV (Fantasy Violence)

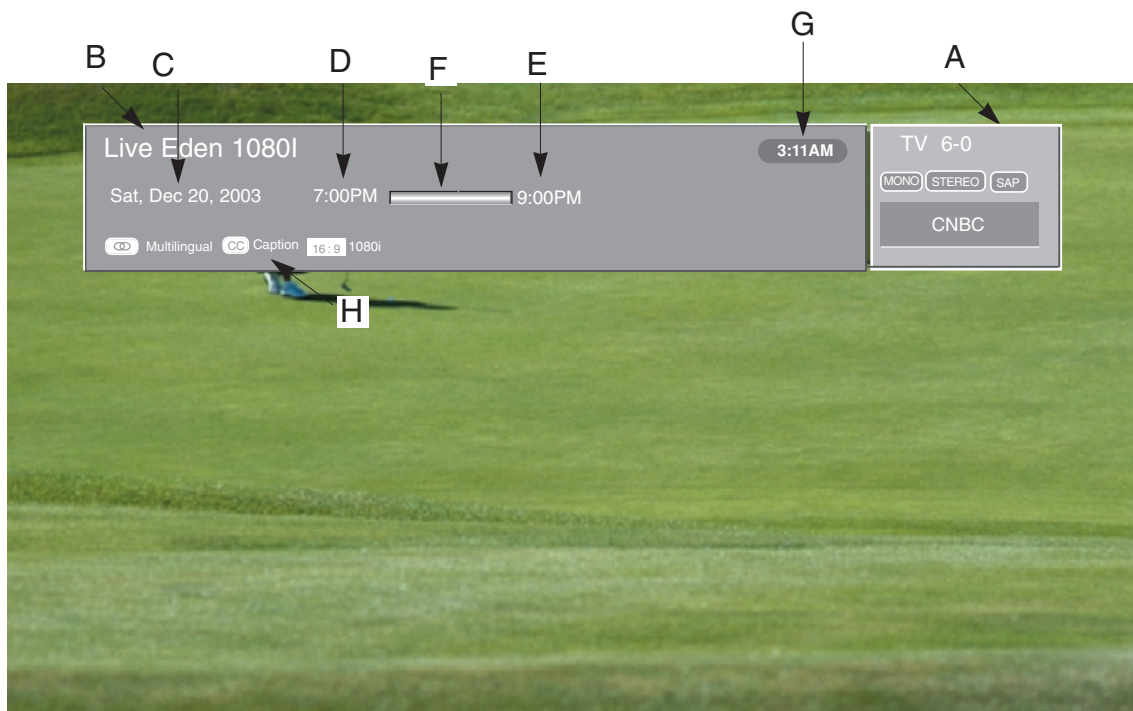

Programming the Remote

The Remote Control for your HD receiver is a multi-brand or universal Remote Control that can be programmed to operate most remote-controllable devices of other manufacturers.

Note: The Remote Control may not be able to control all models of other brands.

1. Test your Remote Control.

To find out whether your remote control can operate the device without programming, turn on the device such as a the VCR and press the corresponding mode button (VCR) on the remote control while pointing at the device. Test the **POWER** and **CH +/-** buttons to see if the device responds properly. If not, the remote requires programming to operate the device.

2. Turn on the device to be programmed. Then press the corresponding mode button on the Remote Control.

3. Press the **POWER** button and the **MUTE** button simultaneously. Now the Remote Control is ready to program the code for the corresponding device.

4. There are two ways to find the right code for the device.

A. If you press the **CH +/-** buttons repeatedly, the codes will change one at a time. Press the **POWER** button after each code change. If the right code is found, the device will turn off.

B. Enter a code number using the number buttons on the Remote Control. The right code numbers for the corresponding component can be found on the following pages. Again, if the code is correct, the device will turn off.

5. Press the **EXIT** button to store the program.

6. Test the Remote Control functions to see if the device responds properly. If not, repeat from step 2.

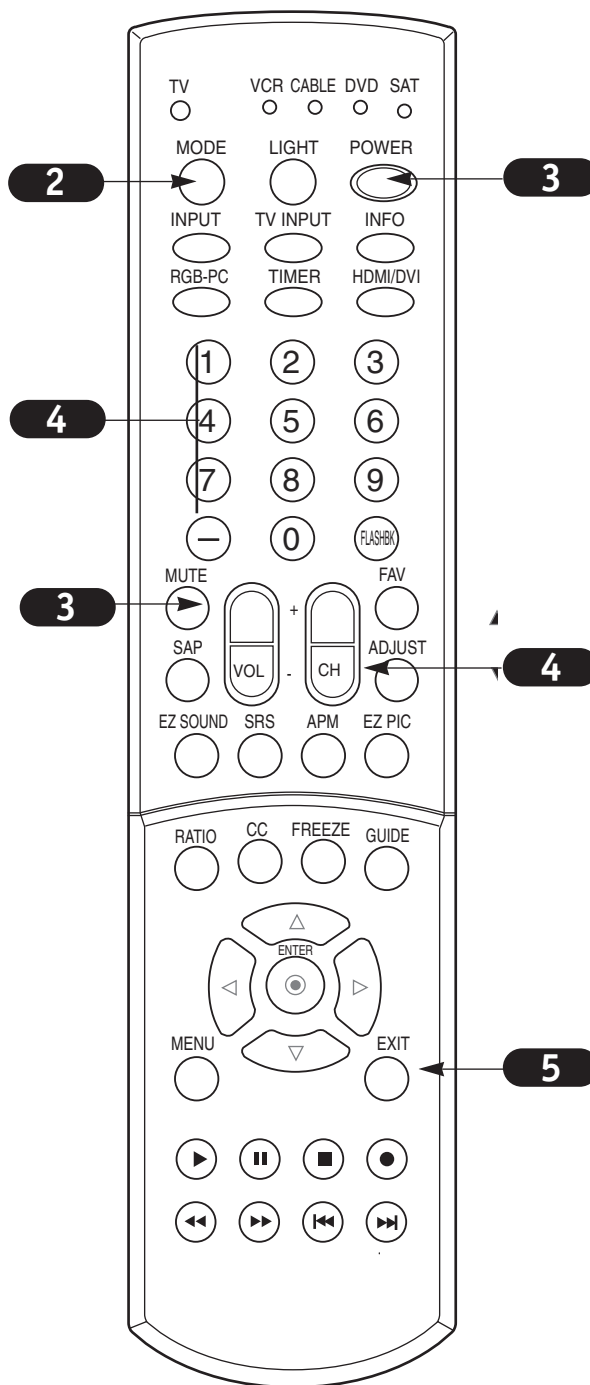

Programming Codes

TVs

Brand	Codes	Brand	Codes	Brand	Codes	Brand	Codes
A MARK	112 143	GOLDSTAR	004 102 106		019 024 040	Sharp	004 014 019
ADMIRAL	072 081 161		110 112 113		056 130 132		022 028 029
AKAI	006 146		116 119 122		134		081 143 170
AMPRO	073 167		127 137 143	NIKEI	043		175
AMSTRAD	052	HALL MARK	004 116	ONKING	043	SIEMENS	088
ANAM	043 054 056	HITACHI	004 006 009	ONWA	043	SIGNATURE	072
	080 104 108		010 011 012	OPTONICA	019 081	SONY	041 070 079
	112 115 118		023 041 075	PANASONIC	034 056 080		085 126 139
	121 131		143 158 163		092 164		147 185
AOC	004 006 058		166	PHILCO	003 004 006	SOUNDESIGN	003 004 028
	112	INFINITY	164		024 043 056		043 116
BLAUPUNKT 088		INKEL	129		059 060 063	SPECTRICON 112	
CANDLE	002 003 004	JBL	164		064 127 143	SSS	004 043
	006	JCPENNY	004 006 008		164	SUPRE MACY	002
CAPEHART	058		009 024 030	PHILIPS	003 004 005	SYLVANIA	003 004 006
CETRONIC	043		065 101 143		006 038 059		044 059 060
CITIZEN	002 003 004		156 160		070 093 143		063 064 116
	006 043 101	JENSEN	013		160 164		127 140 160
	103 143	JVC	034 038 070	PIONEER	006 018 023		164
CLASSIC	043		083 145		025 027 116	TANDY	081
CONCERTO	004	KEC	043		135 176	TATUNG	056 062
CONTEC	039 043 050	KENWOOD	006 070	PORTLAND	004 143	TECHNICS	034 080 084
	051	KLOSS	002 059	PROSCAN	144 160 161	TECHWOOD	004
CORONADO	143	KMC	143		165 167	TEKNIKA	002 003 004
CRAIG	043 054	KTV	006 043 143	PROTON	004 058 116		006 024 028
CROWN	043 143		154		131 143 171		031 043 072
CURTIS MATHES	004 006 101	LG	255		173		077 101 103
	116 143	LODGENET	072	QUASAR	034 056 092		143
CXC	043	LOGIK	072	RADIO SHACK	019 043 047	TELEFUNKEN037 046 086	
DAEWOO	004 016 017	LUXMAN	004		116 127 143	087	
	043 044 055	LXI	007 015 052	RCA	004 006 023	TELERENT	072
	071 076 103		081 160 164		024 056 065	TERA	172
	107 111 114		166		074 144 152	TMK	004 116
	117 120 123	MAGNAVOX	003 004 006		156 160 161	TOSHIBA	007 015 030
	125 127 128		022 059 060		165		040 051 062
	136 143		061 063 064	REALISTIC	007 019 043		101 138
DAYTRON	004 116 143		127 143 160		047	TOTEVISION	143
DYNASTY	043		164	ROCTEC	186	UNIVERSAL	008 009
DYNATECH	062	MARANTZ	006 077 164	RUNCO	168 169	VIDEO CONCEPTS	146
ELECTROHOME	024 077 143	MATSUI	164	SAMPO	004 006 058	VIDIKRON	174
EMERSON	004 005 006	MEMOREX	004 007 072		116	VIDTECH	004 116
	028 043 047		116	SAMSUNG	004 050 089	WARDS	004 008 009
	048 050 051	METZ	088		101 105 113		019 028 060
	096 116 143	MGA	004 006 024		116 127 133		061 063 064
	151 153 154		028 042 049		137 143 160		072 074 116
	155		077 116	SANYO	007 020 021		143 164
FISHER	007 057	MINERVA	088		033 039 053	YAMAHA	004 006
FUNAI	028 043	MITSUBISHI	004 006 024	057 082 166		YORK	004 116
FUTURETECH	043		028 040 042			YUPITERU	043
GE	004 006 008		109 116 124	004 028 043	SCOTT	ZENITH	001 072 073
	009 034 056		146	048 116 143	SEARS		095 103 157
	073 074 091	MTC	004 006 062	004 007 015		ZONDA	112
	116 130 144		101	028 030 057			
	155 160 161	NAD	015 025	082 094 101			
	165	NEC	006 007 016	116 143 160			

SAT

Brand	Codes	Brand	Codes	Brand	Codes	Brand	Codes
ALPHASTAR DSR	123	GENERAL INSTRUMENT	003 004 016	PERSONAL CABLE	117	VIEWSTAR	115
AMPLICA	050		029 031 059	PHILIPS	071	WINEGARD	128 146
BIRDVIEW	051 126 129		101	PICO	105	ZENITH	001 081 082
BSR	053	HITACHI	139 140	PRESIDENT	019 102		083 084 091
CAPETRONICS	053	HOUSTON TRACKER	033 037 039	PRIMESTAR	030 110 111		120
CHANNEL MASTER	013 014 015		051 057 104	PROSAT	072		
	018 036 055	HUGHES	068	RCA	066 106		
CHAPARRAL	008 009 012	HYTEK	053	REALISTIC	043 074		
	077	JANIEL	060 147	SAMSUNG	123		
CITOH	054	JERROLD	061	SATELLITE SERVICE CO	028 035 047		
CURTIS MATHES	050 145	KATHREIN	108		057 085		
DRAKE	005 006 007	LEGEND	057	SCIENTIFIC ATLANTA	032 138		
	010 011 052	LG	255	SONY	103		
	112 116 141	LUTRON	132	STARCAST	041		
DX ANTENNA	024 046 056	LUXOR	062 144	SUPER GUIDE	020 124 125		
	076	MACOM	010 059 063	TEECOM	023 026 075		
ECHOSTAR	038 040 057		064 065		087 088 090		
	058 093 094	MEMOREX	057		107 130 137		
	095 096 097	NEXTWAVE	028 124 125	TOSHIBA	002 127		
	098 099 100	NORSAT	069 070	UNIDEN	016 025 042		
	122	PACE SKY SATELLITE	143		043 044 045		
ELECTRO HOME	089	PANASONIC	060 142		048 049 078		
EUROPLUS	114	PANSAT	121		079 080 086		
FUJITSU	017 021 022				101 135 136		
	027 133 134						

Audio

Brand	Codes	Brand	Codes	Brand	Codes	Brand	Codes
APEX DIGITAL	022		025	PHILIPS	013	THOMPSON	005 006
DENON	020 014	MAGNAVOX	013	PIONEER	004 026	TOSHIBA	019 008
GE	005 006	MARANTZ	024	PROCEED	021	YAMAHA	009 018
GOLDSTAR	010 016 025	MITSUBISHI	002	PROSCAN	005 006	ZENITH	010 016 025
HARMAN KARDON	027	NAD	023	RCA	005 006		
JVC	012	ONKYO	008 017	SAMSUNG	011 015		
LG	001 010 016	PANASONIC	003 009	SONY	007		

DVD

Brand	Codes	Brand	Codes	Brand	Codes	Brand	Codes
APEX DIGITAL	022		025	PHILIPS	013	THOMPSON	005 006
DENON	020 014	MAGNAVOX	013	PIONEER	004 026	TOSHIBA	019 008
GE	005 006	MARANTZ	024	PROCEED	021	YAMAHA	009 018
GOLDSTAR	010 016 025	MITSUBISHI	002	PROSCAN	005 006	ZENITH	010 016 025
HARMAN KARDON	027	NAD	023	RCA	005 006		
JVC	012	ONKYO	008 017	SAMSUNG	011 015		
LG	001 010 016	PANASONIC	003 009	SONY	007		

Troubleshooting Checklist

No picture & No sound

- Check whether the TV is turned on.
- Is the power cord inserted into wall power outlet?
; Is the power cord connected to the TV set properly?
- Test the wall power outlet, plug another product's power cord into the outlet where the TV's power cord was plugged in.

Picture OK & No sound

- Press the **VOLUME** (▲ / ▼) button.
- Sound muted? Press **MUTE** button.

The remote control doesn't work

- Check to see if there is any object between the TV and the remote control causing obstruction.
- Are batteries installed with correct polarity (+ to +, - to -)?
(Refer to p.12)
- Correct remote operating mode set: TV, VCR etc.?
- Install new batteries. (Refer to p.12)

Picture appears slowly after switching on

- This is normal, the image is muted during the TV startup process. Please contact your service center, if the picture has not appeared after five minutes.

No or poor color or poor picture

- Select **Color** in the **Picture** menu and press the ► button.
(Refer to p.26)
- Keep a sufficient distance between the TV and the VCR.
- Activate any function to restore the brightness of the picture.

Horizontal/vertical bars or picture shaking

- Check for local interference such as an electrical appliance or power tool.

No output from one of the speakers

- Adjust **Balance** in the **AUDIO** menu. (Refer to p.34)

Unusual sound from inside the TV

- A change in ambient humidity or temperature may result in the unit turning off and does not indicate a fault with the TV.

Poor TV input signal

- Check ANTENNA and CABLE connection.

Poor Video signal

- Check ANTENNA and CABLE connection.

No channel or a few channel

- Start EZ Scan.

Unsuitable Aspect Ratio

- You can adjust the **RATIO** button or **Aspect Ratio** in the **OPTION** menu.

Maintenance

- Early malfunctions can be prevented. Careful and regular cleaning can extend the amount of time you will have your new TV. Be sure to turn the power off and unplug the power cord before you begin any cleaning.

Cleaning the Screen

1. Here's a great way to keep the dust off your screen for a while. Wet a soft cloth in a mixture of lukewarm water and a little fabric softener or dish washing detergent. Wring the cloth until it's almost dry, and then use it to wipe the screen.
2. Make sure the excess water is off the screen, and then let it air-dry before you turn on your TV.

Cleaning the Cabinet

To remove dirt or dust, wipe the cabinet with a soft, dry, lint-free cloth. Please be sure not to use a wet cloth.

Extended Absence



If you expect to leave your TV dormant for a long time (such as a vacation), it's a good idea to unplug the power cord to protect against possible damage from lightning or power surges.

Product Specifications

MODELS	Z52DC2D	Z56DC1D	Z62DC1D
Horizontal Size (inches)	47.5	58.1	63.3
Height (inches)	33.8	36.8	40.1
Depth (inches)	15.6	17.2	19.5
Weight (lbs.)	68.0	87.1	98.1
Power requirement	AC120V ~ 60Hz		
Television System	NTSC-M, ATSC, 64 & 256 QAM		
Program Coverage	VHF 2 ~ 13, UHF 14 ~ 69, CATV 1 ~ 135, CADTV 1 ~ 135, DTV 2 ~ 69		
Power Consumption (W)	210W		
Antenna	75 ohm External Terminal for VHF/UHF		
Audio Output (W)	15Wx2		
Supplied Accessories	Remote Control, 2 size AA batteries, D-sub 15 pin Cable, Power Cord		

- The specifications shown above may be changed without prior notice for quality improvement.

ZENITH ELECTRONICS CORPORATION

DLP Projection TV Limited Warranty - USA



Zenith will repair or replace your product, at Zenith's option, if it proves to be defective in material or workmanship under normal use, during the warranty period ("Warranty Period") listed below, effective from the date ("Date of Purchase") of original consumer purchase of the product. This warranty is good only to the original purchaser of the product and effective only when used in the United States, excluding U.S. Territories.

<p>WARRANTY PERIOD:</p> <p>LABOR: One Year from the Date of Purchase.</p> <p>Parts: One Year from the Date of Purchase.</p> <p>Halogen Bulb: One Year from the Date of Purchase.</p> <p>* Parts replaced are warranted for the remaining portion of the original warranty period.</p>	<p>HOW SERVICE IS HANDLED:</p> <p>In-Home Service: Please retain dealer's dated bill of sale or delivery ticket as evidence of the Date of Purchase for proof of warranty, and submit a copy of the bill of sale to the service person at the time warranty service is provided.</p> <p>Please call 1-877-9Zenith (1-877-993-6484) to locate your nearest Zenith Authorized Service Center.</p> <p>Replacement parts may be new or factory remanufactured.</p>
---	---

THIS WARRANTY IS IN LIEU OF ANY OTHER WARRANTIES, EXPRESS OR IMPLIED, INCLUDING WITHOUT LIMITATION, ANY WARRANTY OF MERCHANTABILITY OR FITNESS FOR A PARTICULAR PURPOSE. TO THE EXTENT ANY IMPLIED WARRANTY IS REQUIRED BY LAW, IT IS LIMITED IN DURATION TO THE EXPRESSED WARRANTY PERIOD ABOVE. ZENITH WILL NOT BE LIABLE FOR ANY INCIDENTAL, CONSEQUENTIAL, INDIRECT, SPECIAL OR PUNITIVE DAMAGES OF ANY NATURE, EVEN IF ADVISED OF THE POSSIBILITY OF SUCH DAMAGES, INCLUDING WITHOUT LIMITATION, LOST REVENUES OR PROFITS, LOST OR CORRUPTED PROGRAMMING OR DATA, OR ANY OTHER DAMAGE WHETHER BASED IN CONTRACT, TORT, OR OTHERWISE. Some states do not allow the exclusion or limitation of incidental or consequential damages or limitation on how long an implied warranty lasts, so the above exclusion or limitation may not apply to you. This warranty gives you specific legal rights and you may also have other rights that may vary from state to state.

THIS LIMITED WARRANTY DOES NOT APPLY TO:

1. Damages or operating problems that result from shipping, installation, adjustment of user controls, calibration, maintenance or failure to maintain, or separate system components; and
2. Damages or operating problems that result from normal wear and tear, misuse, abuse, operation outside environmental specifications or contrary to the requirements or precautions in the Operating Guide, accident, lightning strikes or other natural causes, unauthorized modification or alteration, incorrect electrical current or voltage, reception problem caused by inadequate home antenna or faulty antenna connections, computer software, institutional or commercial use, or other causes not arising out of defect in material or workmanship.
3. **Therefore, the cost of repair or replacement of such a defective product shall be borne by the consumer.**

CUSTOMER INTER-ACTIVE CENTER NUMBERS:

<p>For nearest Authorized Service Center, Where to buy, Product Assistance, or Customer Assistance</p>	<p>Call 1-877-9Zenith (1-877-993-6484) (24 hours a day, 365 days per year) and select an appropriate option from the menu.</p> <p>Or visit our website at http://www.zenithservice.com</p>
---	---

LG Customer Interactive Center
 201 James Record Road
 Huntsville, Alabama 35824
<http://www.zenithservice.com>

P/N: 38289U0570A @

Free Manuals Download Website

<http://myh66.com>

<http://usermanuals.us>

<http://www.somanuals.com>

<http://www.4manuals.cc>

<http://www.manual-lib.com>

<http://www.404manual.com>

<http://www.luxmanual.com>

<http://aubethermostatmanual.com>

Golf course search by state

<http://golfingnear.com>

Email search by domain

<http://emailbydomain.com>

Auto manuals search

<http://auto.somanuals.com>

TV manuals search

<http://tv.somanuals.com>