

zenith

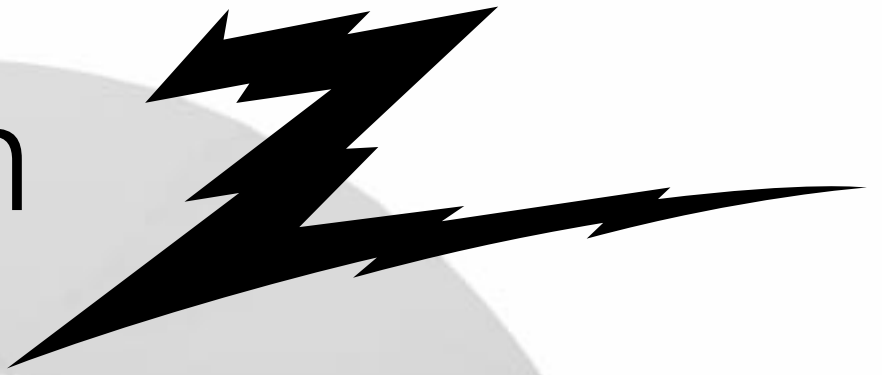

Concierge™
Direct-View
Television
Receiver

installation & operating guide / warranty

RECORD YOUR MODEL NUMBER

The model and serial number of your new TV are located on the back of the TV cabinet. For your future convenience, we suggest that you record these numbers here:

MODEL NO. _____

SERIAL NO. _____



WARNING
RISK OF ELECTRIC SHOCK
DO NOT OPEN



WARNING:

TO REDUCE THE RISK OF ELECTRIC SHOCK DO NOT REMOVE COVER (OR BACK). NO USER SERVICEABLE PARTS INSIDE. REFER TO QUALIFIED SERVICE PERSONNEL.



The lightning flash with arrowhead symbol, within an equilateral triangle, is intended to alert the user to the presence of uninsulated "dangerous voltage" within the product's enclosure that may be of sufficient magnitude to constitute a risk of electric shock to persons.



The exclamation point within an equilateral triangle is intended to alert the user to the presence of important operating and maintenance (servicing) instructions in the literature accompanying the appliance.

WARNING:

TO PREVENT FIRE OR SHOCK HAZARDS, DO NOT EXPOSE THIS PRODUCT TO RAIN OR MOISTURE.

POWER CORD POLARIZATION:

CAUTION: TO PREVENT ELECTRIC SHOCK, MATCH WIDE BLADE OF PLUG TO WIDE SLOT, FULLY INSERT.

ATTENTION: POUR ÉVITER LES CHOCS ÉLECTRIQUES, INTRODUIRE LA LAME LA PLUS LARGE DE LA FICHE DANS LA BORNE CORRESPONDANTE DE LA PRISE ET POUSSER JUSQU'AU FOND.

NOTE TO CABLE/TV INSTALLER:

This reminder is provided to call the cable TV system installer's attention to Article 820-40 of the National Electric Code (U.S.A.). The code provides guidelines for proper grounding and, in particular, specifies that the cable ground shall be connected to the grounding system of the building, as close to the point of the cable entry as practical.

REGULATORY INFORMATION:

This equipment has been tested and found to comply with the limits for a Class B digital device, pursuant to Part 15 of the FCC Rules. These limits are designed to provide reasonable protection against harmful interference when the equipment is operated in a residential installation. This equipment generates, uses and can radiate radio frequency energy and, if not installed and used in accordance with the instruction manual, may cause harmful interference to radio communications. However, there is no guarantee that interference will not occur in a particular installation. If this equipment does cause harmful interference to radio or television reception, which can be determined by turning the equipment off and on, the user is encouraged to try to correct the interference by one or more of the following measures:

- Reorient or relocate the receiving antenna.
- Increase the separation between the equipment and receiver.
- Connect the equipment into an outlet on a circuit different from that to which the receiver is connected.
- Consult the dealer or an experienced radio/TV technician for help.

CAUTION:

Do not attempt to modify this product in any way without written authorization from Zenith Electronics Corporation. Unauthorized modification could void the user's authority to operate this product.

Concierge is a trademark of Zenith Electronics Corporation © Copyright 1999 Zenith Electronics Corporation

IMPORTANT SAFETY INSTRUCTIONS

Important safeguards for you and your new product

Your product has been manufactured and tested with your safety in mind. However, improper use can result in potential electrical shock or fire hazards. To avoid defeating the safeguards that have been built into your new product, please read and observe the following safety points when installing and using your new product, and save them for future reference.

Observing the simple precautions discussed in this booklet can help you get many years of enjoyment and safe operation that are built into your new product.

This product complies with all applicable U.S. Federal safety requirements, and those of the Canadian Standards Association.

1. Read Instructions

All the safety and operating instructions should be read before the product is operated.

2. Follow Instructions

All operating and use instructions should be followed.

3. Retain Instructions

The safety and operating instructions should be retained for future reference.

4. Heed Warnings

All warnings on the product and in the operating instructions should be adhered to.

5. Cleaning

Unplug this product from the wall outlet before cleaning. Do not use liquid cleaners or aerosol cleaners. Use a damp cloth for cleaning.

6. Water and Moisture

Do not use this product near water for example, near a bath tub, wash bowl, kitchen sink, or laundry tub, in a wet basement, or near a swimming pool.

7. Accessories

Do not place this product on an unstable cart, stand, tripod, bracket, or table. The product may fall, causing serious injury to a child or adult, and serious damage to the product. Use only with a cart, stand, tripod, bracket, or table recommended by the manufacturer, or sold with the product. Any mounting of the product should follow the manufacturer's instructions, and should use a mounting accessory recommended by the manufacturer.

8. Transporting Product

A product and cart combination should be moved with care. Quick stops, excessive force, and uneven surfaces may cause the product and cart combination to overturn.

9. Attachments

Do not use attachments not recommended by the product manufacturer as they may cause hazards.

10. Ventilation

Slots and openings in the cabinet are provided for ventilation and to ensure reliable operation of the product and to protect it from overheating, and these openings must not be blocked or covered. The openings should never be blocked by placing the product on a bed, sofa, rug, or other similar surface. This product should not be placed in a built-in installation such as a bookcase or rack unless proper ventilation is provided or the manufacturer's instructions have been adhered to.

11. Power Sources

This product should be operated only from the type of power source indicated on the marking label. If you are not sure of the type of power supply to your home, consult your product dealer or local power company. For products intended to operate from battery power, or other sources, refer to the operating instructions.

12. Line-Cord Polarization

This product is equipped with a polarized alternating-current line plug (a plug having one blade wider than the other). This plug will fit into the power outlet only one way. This is a safety feature. If you are unable to insert the plug fully into the outlet, try reversing the plug. If the plug should still fail to fit, contact your electrician to replace your obsolete outlet. Do not defeat the safety purpose of the polarized plug.

13. Power-Cord Protection

Power-supply cords should be routed so that they are not likely to be walked on or pinched by items placed upon or against them, paying particular attention to cords at plugs, convenience receptacles, and the point where they exit from the product.



PORTABLE CART WARNING

(Continued on next page)

IMPORTANT SAFETY INSTRUCTIONS

(Continued from previous page)

14. Outdoor Antenna Grounding

If an outside antenna or cable system is connected to the product, be sure the antenna or cable system is grounded so as to provide some protection against voltage surges and built-up static charges. Article 810 of the National Electrical Code (U.S.A.), ANSI/ NFPA 70 provides information with regard to proper grounding of the mast and supporting structure, grounding of the lead-in wire to an antenna discharge unit, size of grounding conductors, location of antenna-discharge unit, connection to grounding electrodes, and requirements for the grounding electrode.

Example of Grounding According to National Electrical Code Instructions

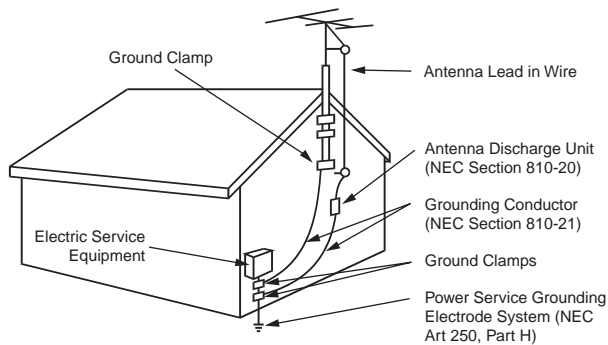

15. Lightning

For added protection for this product (receiver) during a lightning storm, or when it is left unattended and unused for long periods of time, unplug it from the wall outlet and disconnect the antenna or cable system. This will prevent damage to the product due to lightning and power-line surges.

16. Power Lines

An outside antenna system should not be located in the vicinity of overhead power lines or other electric light or power circuits, or where it can fall into such power lines or circuits. When installing an outside antenna system, extreme care should be taken to keep from touching such power lines or circuits as contact with them might be fatal.

17. Overloading

Do not overload wall outlets and extension cords as this can result in a risk of fire or electric shock.

18. Object and Liquid Entry

Never push objects of any kind into this product through openings as they may touch dangerous voltage points or short-out parts that could result in a fire or electric shock. Never spill liquid of any kind on the product.

19. Servicing

Do not attempt to service this product yourself as opening or removing covers may expose you to dangerous voltage or other hazards. Refer all servicing to qualified service personnel.

20. Damage Requiring Service

Unplug this product from the wall outlet and refer servicing to qualified service personnel under the following conditions:

- If the power-supply cord or plug is damaged.
- If liquid has been spilled, or objects have fallen into the product.
- If the product has been exposed to rain or water.
- If the product does not operate normally by following the operating instructions. Adjust only those controls that are covered by the operating instructions as an improper adjustment of other controls may result in damage and will often require extensive work by a qualified technician to restore the product to its normal operation.
- If the product has been dropped or the cabinet has been damaged.
- If the product exhibits a distinct change in performance.

21. Replacement Parts

When replacement parts are required, be sure the service technician has used replacement parts specified by the manufacturer or have the same characteristics as the original part. Unauthorized substitutions may result in fire, electric shock, or other hazards.

22. Safety Check

Upon completion of any service or repairs to this product, ask the service technician to perform safety checks to determine that the product is in proper operating condition.

23. Wall or Ceiling Mounting

The product should be mounted to a wall or ceiling only as recommended by the manufacturer.

24. Heat

The product should be situated away from heat sources such as radiators, heat registers, stoves, or other products (including amplifiers) that produce heat.

Table of Contents

Turn to the next page to begin the TV setup

Safety Warnings	2	Captions Caption/Text	21
Important Safety Information	3	Language	22
Table of Contents	5		
Step 1. Hook Up TV		Audio Menu	23
Hookup Directory	6	Bass, Treble, Balance, Audio Mode, Front Surround, Sound Rite, Speakers	
TV and other Equipment Hookups		Video Menu	24
Antenna	7	Contrast, Brightness, Color, Tint, Sharpness, Picture Pref.	
Cable service	8	Installer Parental Control Menu	25
Antenna with VCR	9	Setup Parental Control	
Cable service with VCR	10	Other Menus and On-Screen Displays	27
External Speaker	11	Managing the Channel Banks	28
Step 2. Channel Search and Reception Setup		Installer Menus	31
Auto Program	12	LT1500 Quickset Clone Programmer	34
(Select Antenna, or cable service and perform channel search)		Maintenance	37
Front Panel Controls	13	Trouble Shooting	38
Guest's Remote Key Functions	14	Glossary	39
Installer's Remote Key Functions	15		
On-Screen Menus Overview	16	Guest Operation Section (Copy for guest usage)	
Step 3. Customize the TV's Features		Guest Remote Control Key Functions	40
Setup Menu (Start with page 12, Auto Program)		Guest Parental Control Menu	41
Add/Del/Blank	17	Guest Menus and On-Screen Displays	43
Channel Labels	18		
Timer Setup	19	Warranty for Concierge™ Series TVs	Back Cover
Clock Set	20		

Installer/Hotel Note:

Pages 40, 41, 42, and 43 contain information and menus which the guest can use to operate the TV. It is recommended that these four pages be copied and included with the literature packet that the hotel provides to the guest.

Purchase the Optional Installer's Remote and Clone Programmer

To perform the installation setup, you need an installer's remote like the LP702, and the LT1500 Clone Programmer - - both are shown and described in later sections. The installer remote allows access to the Installer menus, User menus, and Source/Channel Banks. The installer remote has Menu, Select, and Adjust Keys (Up/Down/Left/Right arrows) and Source/Channel Bank Keys. The LT1500 Clone Programmer is used to duplicate a TV's setup and install it on another TV. See your Zenith Dealer.

Design and specifications are subject to change without prior notice.

Basic Hook-Up Directory

This page will direct you to which page to go to for proper hook up of the TV

IMPORTANT!!

Use this page to decide where you need to begin your set up. First, find the line below that best describes what you want to do, then go to that page number.

Antenna only

If you are using an antenna and no other equipment, go to page 7

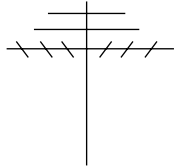

Cable only

If you have cable and no other equipment, go to page 8

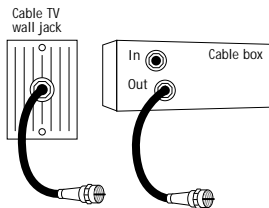

Antenna with VCR

If you are using an antenna and have a VCR, go to page 9

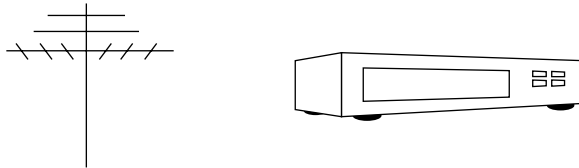

Cable and VCR

If you have cable and a VCR, go to page 10

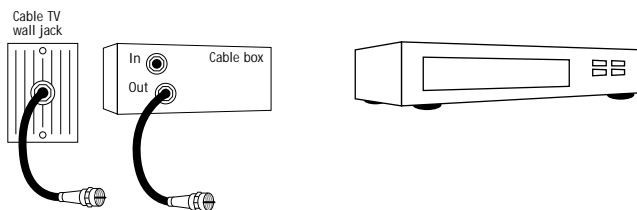

External Speaker

If you want to connect a Matrix speaker, go to page 11

Hook Up Your Antenna to the TV

Connect an off-air antenna to the TV

- 1 Locate the Antenna/Cable jack on the back of the TV.
- 2 Connect the cable that runs from the wall directly to this jack, according to the diagram to the right.
- 3 Remove the back of the remote and put in two AA batteries.

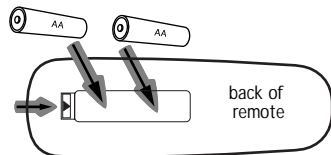

- 4 Plug in the TV. Do not plug it into a switched outlet. The TV is designed to operate on standard current, 120-volt 60 Hertz AC. Do not attempt to operate it on DC Current.

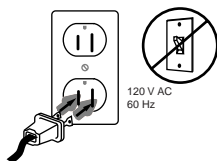

- 5 Go to page 12 to Auto Program the TV.



If you have a 75 ohm RF cable, then you don't need any adapters!



A 300 to 75 ohm adapter is not included with the Zenith TV.

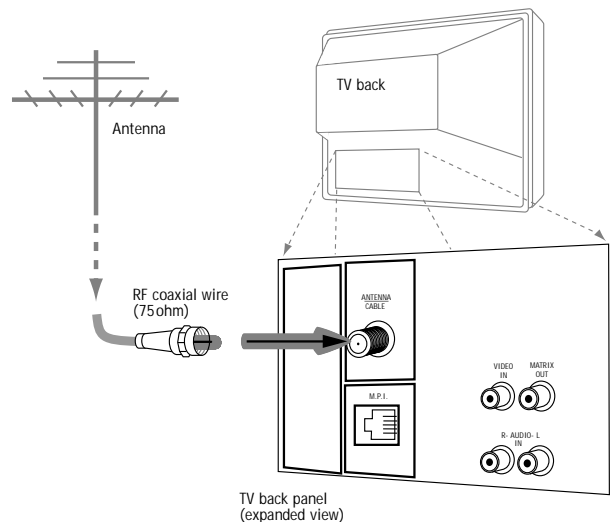
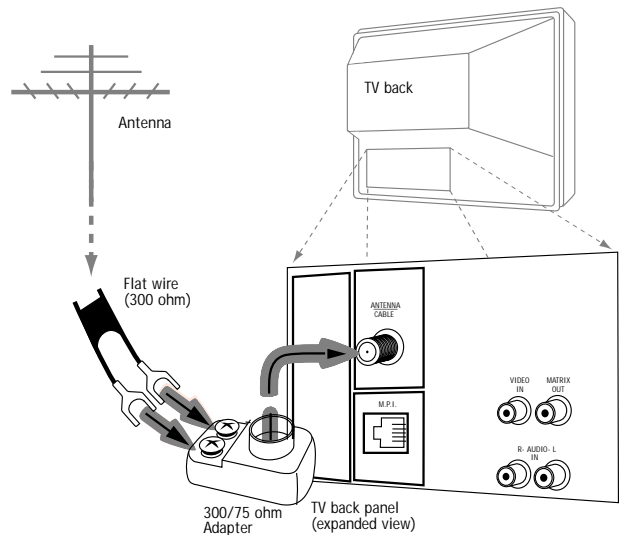

Mini glossary

- 75 OHM RF CABLE** The wire that comes from an off-air antenna or cable service provider. Each end looks like a hex shaped nut with a wire sticking through the middle, and it screws onto the threaded jack on the back of your TV.
- 300 TO 75 OHM ADAPTER** A small device that connects a two-wire 300 ohm antenna to a 75 ohm RF jack. They are usually about an inch long with two screws on one end and a round opening with a wire sticking out on the other end.

Hook Up Your Cable (CATV) to the TV

Connect cable service to the TV

1 Locate the Antenna/Cable jack on the back of the TV.

2 Connect the cable that runs from the wall directly to this jack, according to the diagram to the right.

3 Remove the back of the remote and put in two AA batteries.

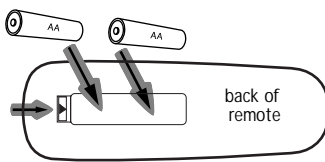

4 Plug in the TV. Do not plug it into a switched outlet. The TV is designed to operate on household current, 120-volt 60 Hertz AC. Do not attempt to operate it on DC Current.

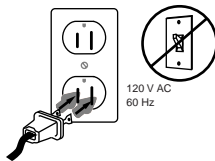

5 Go to page 12 to Auto Program the TV.



If you're using a cable box, leave the TV on channel 3 or 4 and use your cable box to change channels.



If you're using a cable box, Auto Program might only find the channel your cable service is on (usually channel 3 or 4). Don't worry, that's all you need!

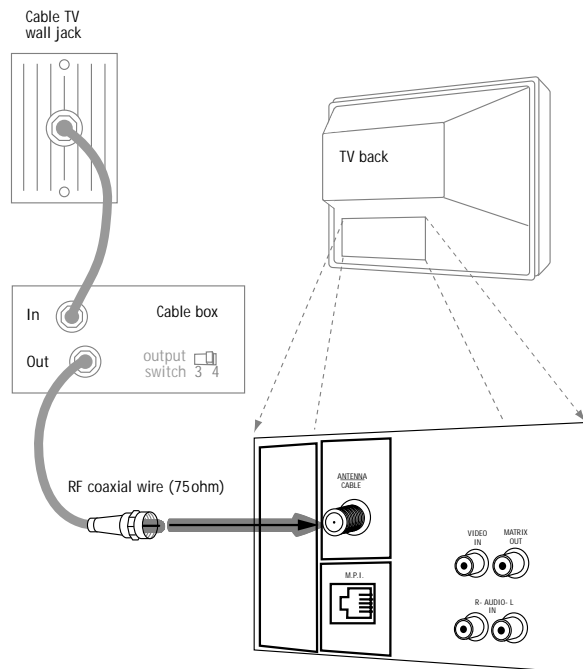
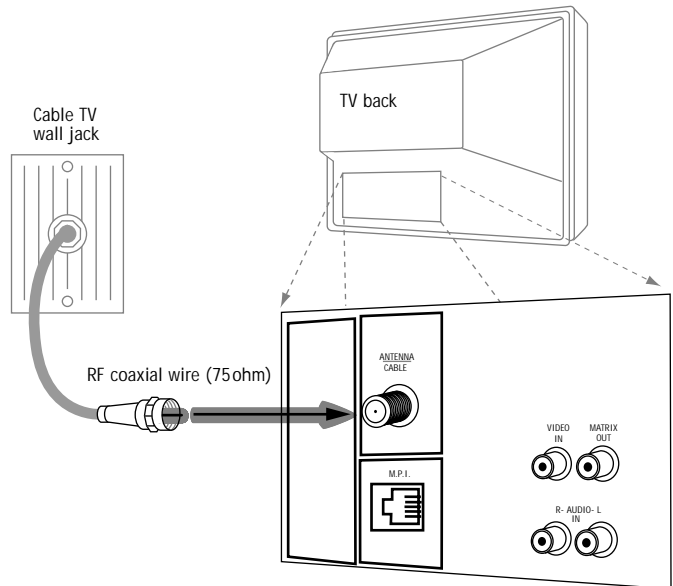

Hook Up Antenna and VCR to the TV

Connect an off-air antenna and VCR to the TV

- 1 Locate the Antenna/Cable jack on the back of the VCR.
- 2 Connect the cable that runs from the antenna directly to this jack, according to the diagram to the right. As required, make the other connections as shown to the right.
- 3 Remove the back of the remote, put in two AA batteries.

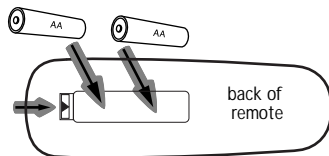

- 4 Plug in the TV. Do not plug it into a switched outlet. The TV is designed to operate on standard current, 120-volt 60 Hertz AC. Do not attempt to operate it on DC Current.

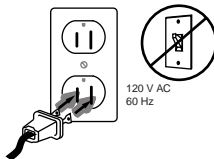

- 5 Go to page 12 to Auto Program the TV.



No A/V cables are included with the Zenith TV.



Without A/V cables, most VCRs will not play videocassettes in stereo sound.

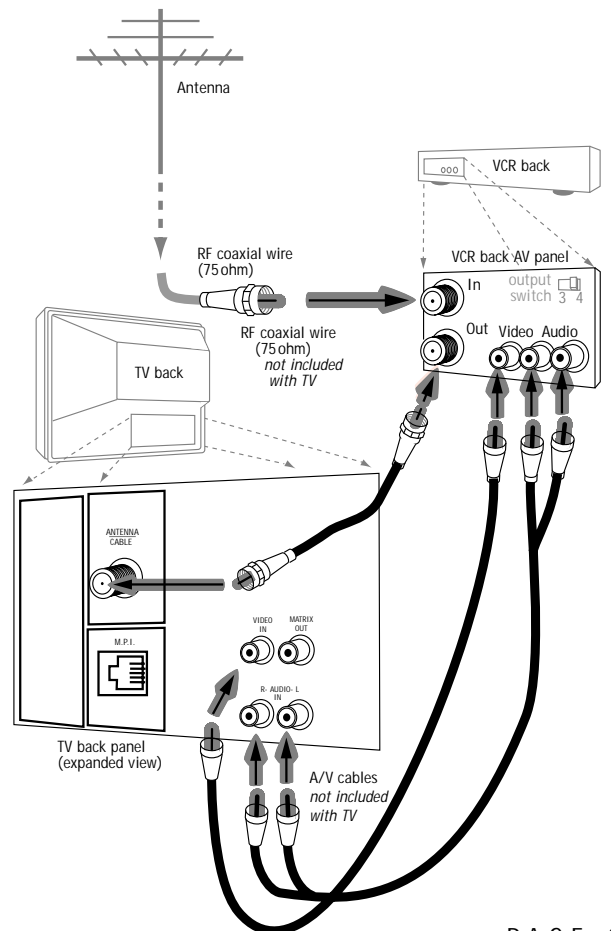
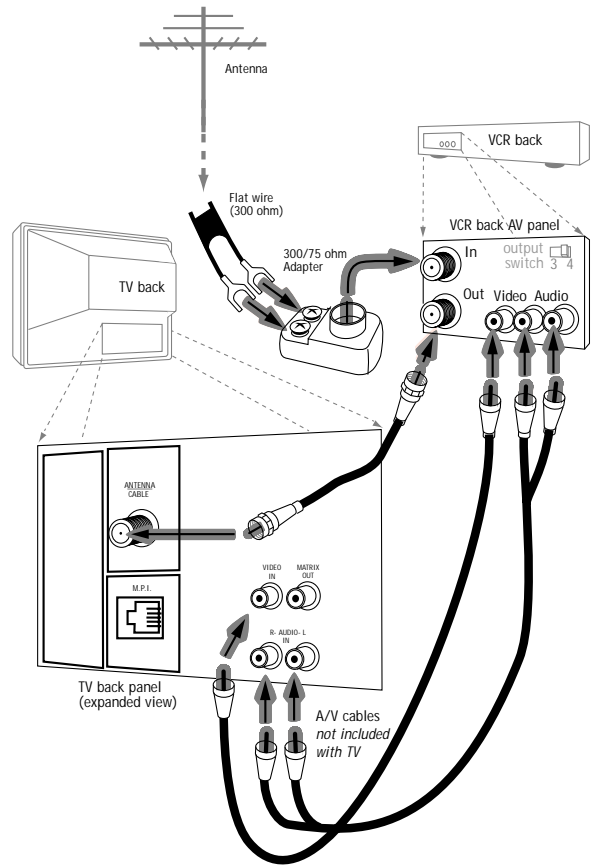

Hook Up Cable Service (CATV) and VCR

Connect a VCR and Cable service to the TV.

- 1** Locate the Antenna/Cable jack on the back of the VCR.
- 2** Connect the cable that runs from the wall directly to this jack, according to the diagram to the right. As required, make the other connections as shown to the right.
- 3** Remove the back of the remote, put in two AA batteries.

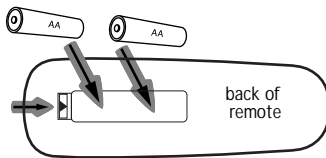

- 4** Plug in the TV. Do not plug it into a switched outlet. The TV is designed to operate on standard current, 120-volt 60 Hertz AC. Do not attempt to operate it on DC Current.

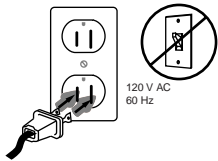

- 5** Go to page 12 to Auto Program the TV.



Leave the VCR and the television tuned to channel three and use the cable box to change channels.



No A/V cables are included with your TV. Without A/V cables, most VCRs will not play videocassettes in stereo sound.

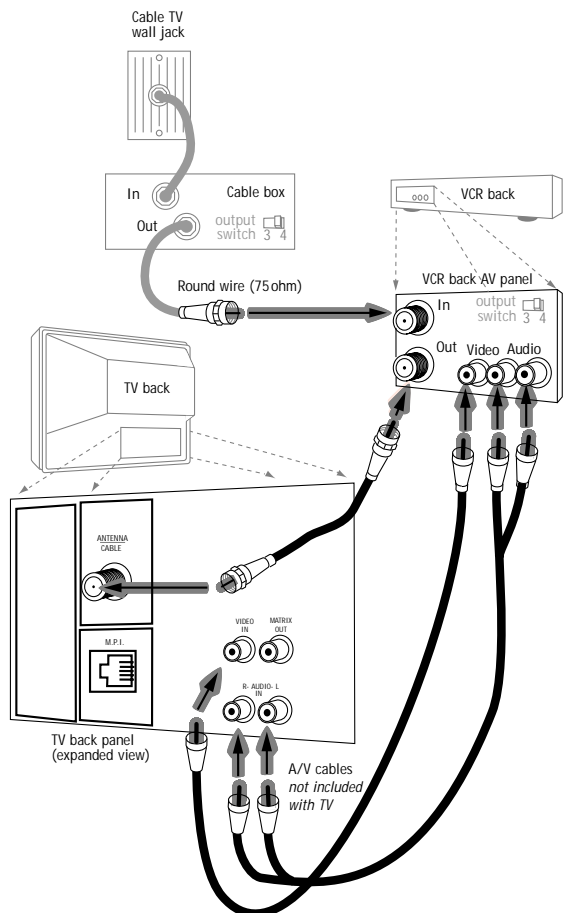
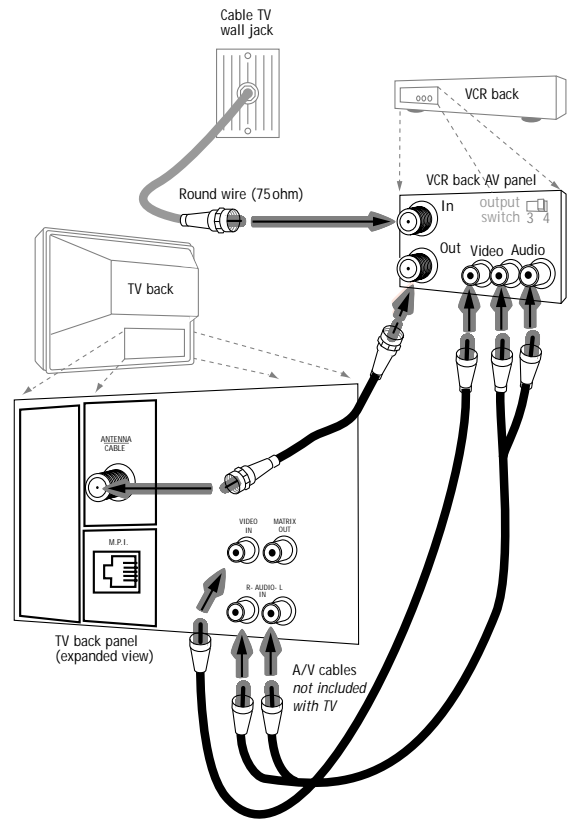

External Speaker Hook Up

Connect an external speaker to the TV.

- 1 Locate the Audio In jack on the back of the speaker.
- 2 Connect a standard audio cable from the Matrix Out jack on the TV, to the Audio In jack on the external speaker.

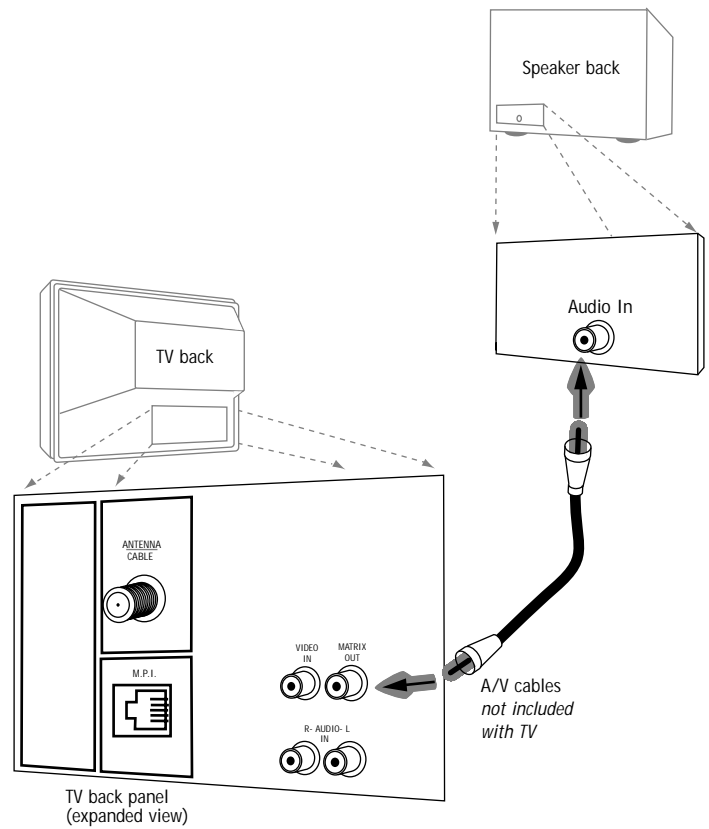

Auto Program (Channel Search)

Use Auto Program to specify Antenna or cable service incoming signal source and automatically store all of the channels that are found by channel search

- 1** With the Installer remote control in hand, press the POWER key to turn on the TV.
- 2** Press MENU repeatedly so the Setup menu appears.
- 3** Using SELECT on the remote control, highlight Auto Program on the screen.
- 4** Press a Right or Left ADJ (Adjust) arrow to reach the Auto Program screen.
- 5** Using SELECT, choose either Cable TV or Off-Air Antenna on your screen. (The flashing option is selected.)
- 6** Press a Right or Left ADJ arrow to begin the Channel Search.
- 7** Press ENTER when finished.



Note: Auto Program finds channels being received by the TV tuner.



Cable will not work unless the lodge provides a cable service.

(If the Auto Program line appears in red, then it did not pass one of the internal tests. To set Auto Program to white, set the upper nibble of the EEPROM location \$1FFh to \$B0h.)

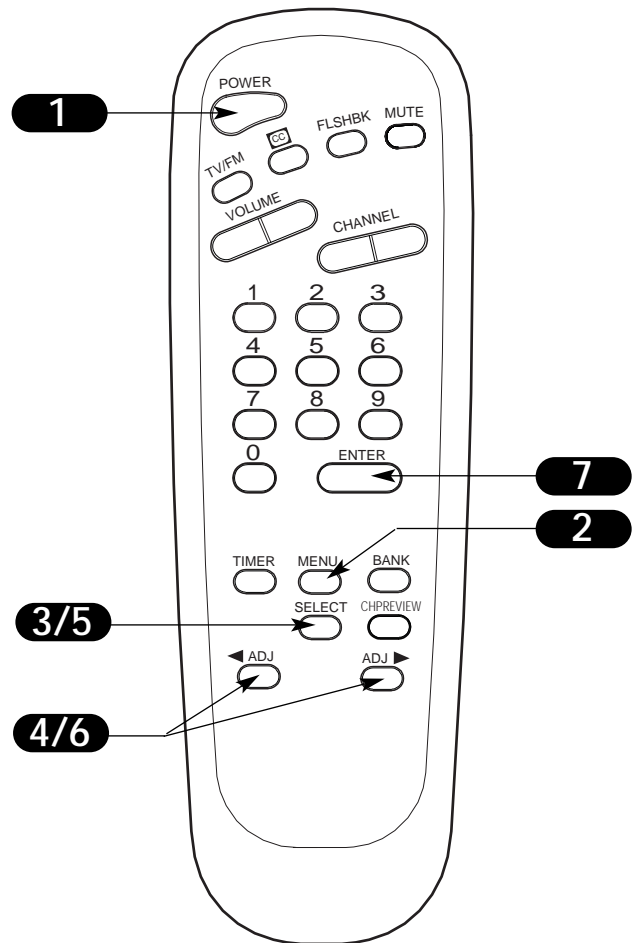
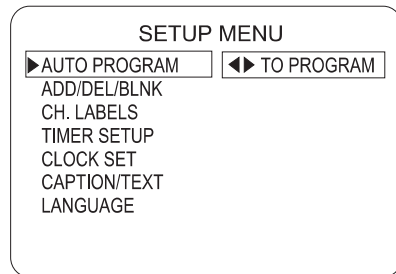

Mini glossary

OFF-AIR-ANTENNA	If the guest can only view over-the-air broadcasts, select Antenna.
CABLE	If you provide cable service to your guests, select Cable.

Front Panel Controls

Using the front control panel to access the menus

- 1 Press ON/OFF to turn on your TV.
- 2 To access the menus press the MENU button on the control panel. Cycle through the various menus by pushing the button repeatedly.
- 3 Press the SELECT button repeatedly to highlight the option you want to modify.
- 4 Press either the Right or Left ADJUST button to modify the option you have chosen.
- 5 The menu will disappear after a few seconds.

There are three jacks on the front of the TV that make connecting Audio/Video devices like camcorders very simple.

To use the front jacks as the signal source, simply plug a composite video cable into the VIDEO jack. The TV will automatically change its source setting to CAMPORT, as indicated on the channel selection screen.



The Front Audio/Video jacks are a direct source connection. If you have a device plugged into the front Video jack, you will not be able to change channels until you have unplugged the front Video jack.

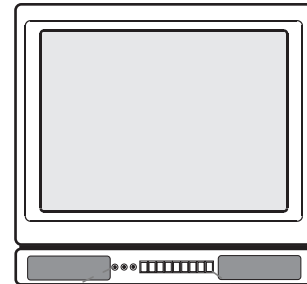

Typical Front Panel Controls

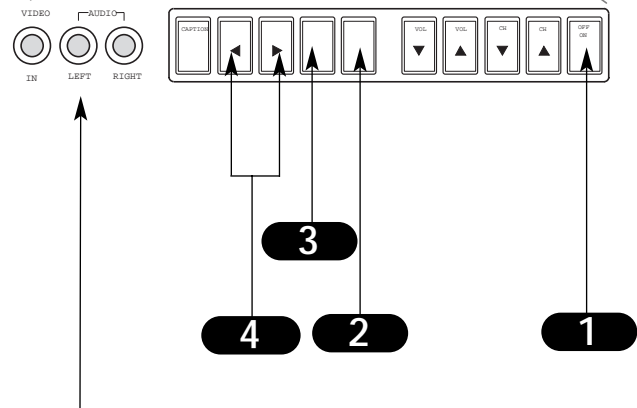

Video

Connects the video signals from any piece of equipment.

Left/Right Audio Used for stereo sound from various types of equipment.

Guest Remote Key Functions

A quick list of the keys on the guest remote and what they do

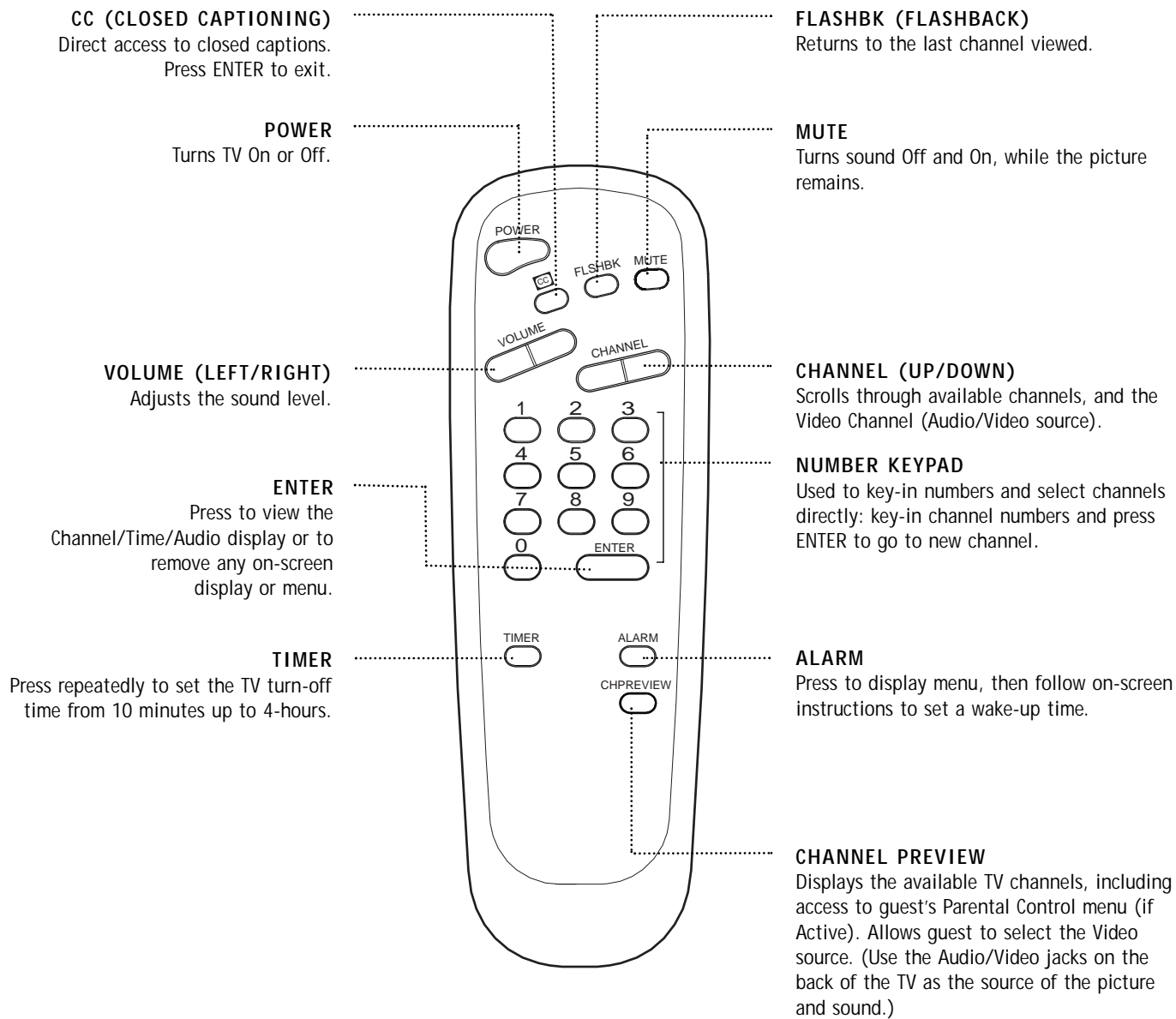

remote control part number
SC652
124-213-02

NOTE:

The channel and volume keys can be used by the guest to select and adjust the Parental Control settings, if the installer activates the Parental Control option in the Installer menu.

Installer Remote Key Functions

A quick list of the keys on the LP702 installer's remote and what they do

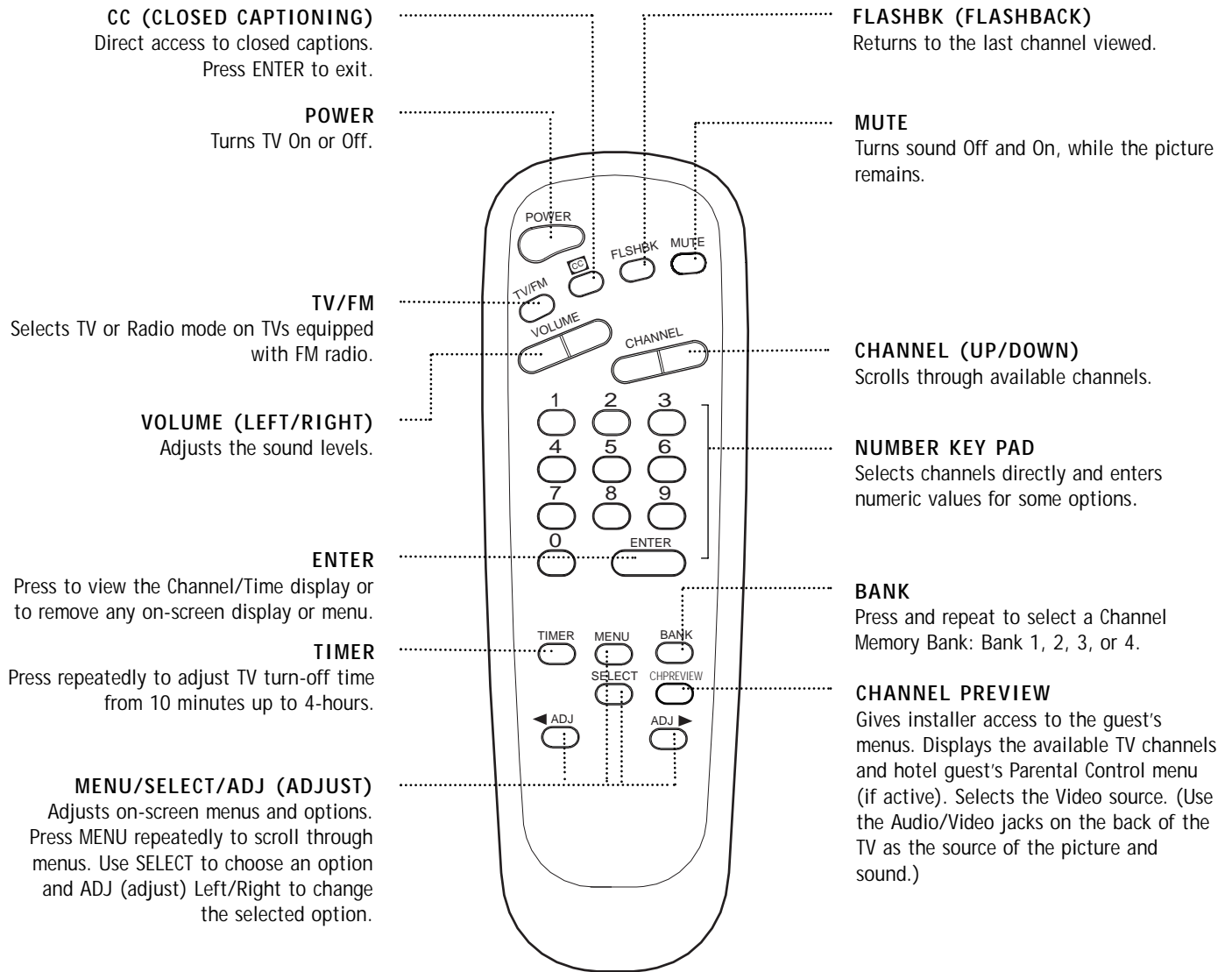

remote control part number
LP702
 124-213-04

Descriptions of the menus and on-screen displays available to the installer

Menu Name	Page	Description
ON-SCREEN MENUS		
SETUP MENU		Adjusts the basic operational features of the TV
Auto Program	12	Automatically finds and stores active channels to scroll through using Channel Up/Down.
Add/Del/Blnk	17	Manually picks and chooses which active channels will appear when using Channel Up/Down
Channel Labels	18	Labels the channels with their network names (ABC, CBS, HBO, etc.).
Timer Setup	19	Programs a time for the TV to turn itself off after a certain period of time has elapsed.
Clock Set	20	Sets the time.
Caption/Text	21	Chooses the captioning or text option.
Language	22	Picks the language the on-screen menus will appear in.
AUDIO MENU	23	Customizes the sound. Options are: Bass, Treble, Balance, Audio Mode, Front Surround, SoundRite, Speakers.
VIDEO MENU	24	Adjusts the picture for any viewing situation. The options are: Contrast, Brightness, Color, Tint, Sharpness, Picture Pref.
PARENTAL	25/44	Allows installer/user to block program content for up to 12 hours, with the use of a password.
CONTROL MENU		
	27	OTHER MENUS AND ON-SCREEN DISPLAYS
Channel/Time		Shows the current time, channel, (or video source) and type of incoming audio signal.
Alarm		Sets the wake-up time.
Sleep Timer		Sets the time the TV will turn off.
Volume		Shows current sound level.
Captions		Used to select Caption/Text options.
Ch Preview		Displays the available channels and menus list.
Channel Bank		Shows currently selected channel bank.
INSTALLER MENUS		
Installer Menus	31	Makes adjustments to the TV's operational features.

Setting Add/Delete/Blank

Fine-tune the guest's channel selection list

- 1 Press the MENU key on the Installer's remote so the Setup menu appears.
- 2 Press SELECT repeatedly to highlight the Add/Del/Blnk option.
- 3 Using either the NUMBER keypad and ENTER or the Channel Up/Down arrows on the remote, select a channel.
(If adding a deleted channel, you will need to use the NUMBER keypad and ENTER.)
- 4 Using the Right/Left ADJ arrows, pick whether that channel is Added, Deleted, or Blank.
- 5 To continue, select another channel and repeat Step 3. When you are finished, press ENTER to remove menu.

Adding Aux, VCR 3, VCR 4, or FM to the Channel Preview List

Go to the Setup menu, select the Add/Del/Blnk option. Use Channel Up/Down to select the option and choose Added.

Note: If the option was turned off in the Service menu, you will have to reinstate it before it can appear as an option in the Channel Preview list.

Notes: Adding VCR 3 and/or VCR 4 as available channels forces TV Channel 3 and/or 4 to be retained, when running Auto Program, even though the equipment connected to the Antenna/Cable (RF) jack (like a cable converter and/or VCR) may be turned off.

You can elect to Add, Delete or Blank: **VCR 3, VCR 4,** and **Aux. FM** can be Added or Deleted, but not Blanked.



If you delete a channel, it isn't gone for good. Just select it using the NUMBER keypad on the remote, or add it later.

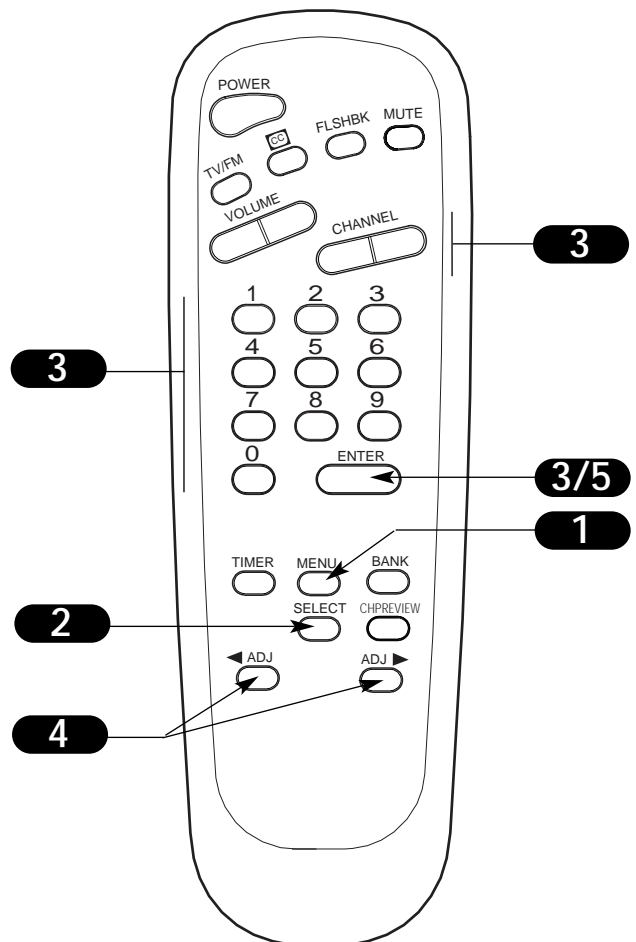
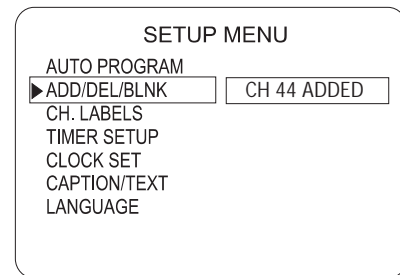

Mini glossary

ADD	Adds new channels to the list that the guest can scroll through when using the remote.
DELETE	Removes channels for one reason or another from the list that the guest can scroll through.
BLANK	Removes the video signal from a channel so the guest will only receive the audio signal.

Setting Up Channel Labels

Overview

Channel Labels help the user identify the channel or network being viewed.

In the Setup menu with the CH LABELS option highlighted, use the Adjust Left/Right arrows to scroll through the available channel labels, such as, A & E, AMC, ESPN, HBO, etc. These are a series of alphabetically organized preset labels from which you can choose the more common networks. Use any of these or create custom labels.

- - - - , The 4 dashes will allow a channel label to appear; if one is provided by XDS. (Extended data service)

NONE, prevents any channel label from appearing.

LAB 1, thru **LAB 20**, are the 20 programmable labels.

The 20 programmable labels can be customized for your needs.

Each programmable label has 5 characters spaces available.

To Program a Channel Label

First select a channel using the NUMBER keypad and ENTER or the Channel Up/Down arrows, on the Installer's remote control.

(To select a deleted channel, use the NUMBER keypad and ENTER.)

To program a channel label, go to the Setup menu and select CH LABELS.

Press the Right/Left adjust arrow to scroll the available preset labels. Scroll past - - - - , scroll past NONE, to go to the first programmable label slot, LAB 1. Notice that the label appears with the title LAB 1, and is also on a dark background; which will distinguish it from the preset labels.

Operating the Menu

Use Volume Up/Down to select the first letter.

Press MUTE to clear the label if necessary.

Use Channel Up/Down to change the character to one of the 255 characters available.

Adjust Left/Right	Switches to the next label. - - moves to the next or previous label.
Volume Up/Down	Selects character spaces - - moves to the next or previous character space.
Channel Up/Down	Scrolls through the available characters.
ENTER	Accept the channel label and removes the menu.
MUTE	Removes current label, - - if first character space is selected.

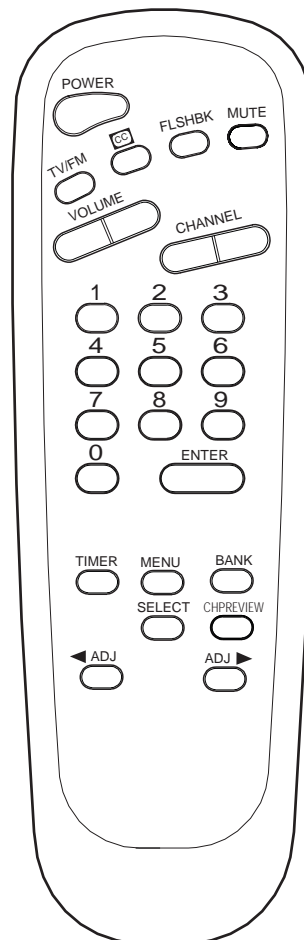
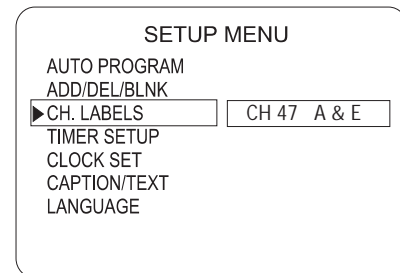

Timer Set Up

Sets the time the TV will automatically turn off

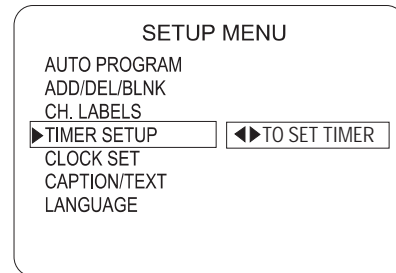

Be sure to set the Clock first, see next page.

- 1 Press MENU to show the Setup menu.
- 2 Use SELECT to highlight Timer Setup.
- 3 With Timer Setup highlighted as shown above, use the Left/Right ADJ arrow to pick from the preset times, the time that the TV will turn itself off, or set the Sleep Timer to Off to disable it.
- 4 Press ENTER to set the timer and return to TV viewing.
- 5 The Sleep Timer may be instantly set by pressing the TIMER key repeatedly. When you have made your selection, press ENTER to set the Sleep Timer and return to TV viewing.

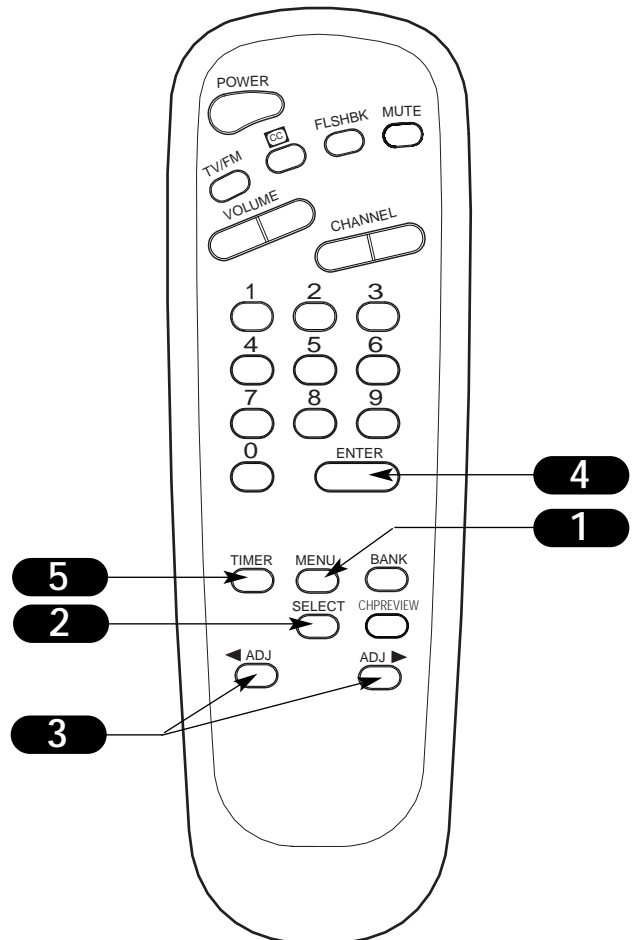

Set the Clock

Sets the TV's internal clock

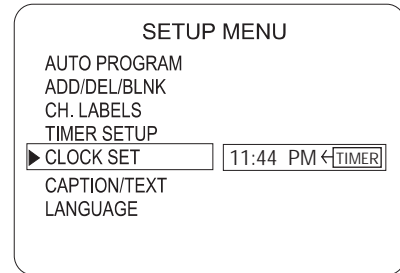

- 1** Press MENU repeatedly to show the Setup menu.
Press SELECT to highlight the Clock Set option.
- 2** Set the current time; use the Number keypad to enter the hours, then minutes. For example, enter 06, then 30, to set 6:30 on the clock.
- 3** Use the TIMER key to specify AM or PM.
- 4** Press ENTER to start the clock and return to TV viewing.

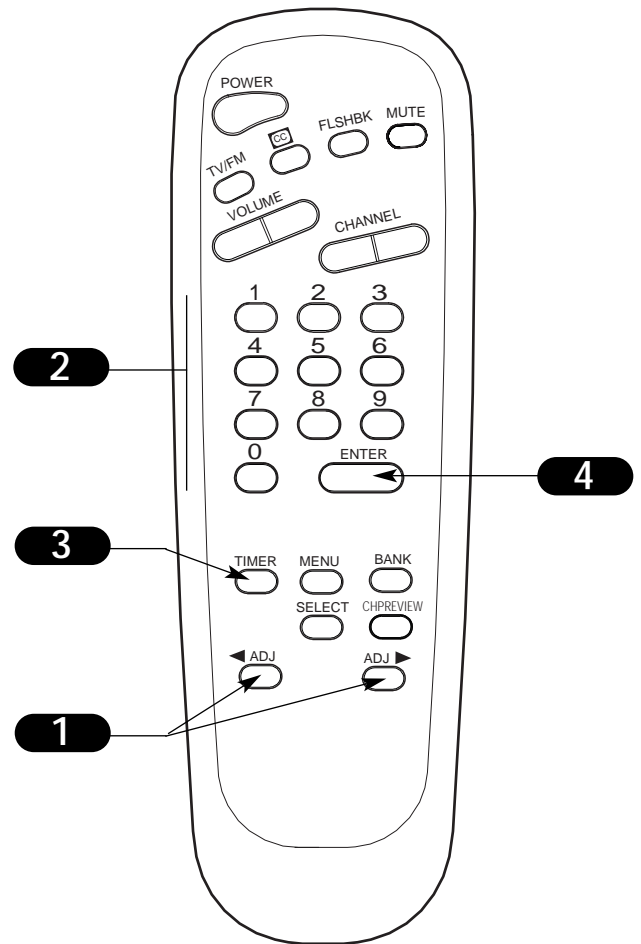

Mini glossary

- TIME** A four-digit figure broken down into hours and minutes; first two digits are hours, last two digits are minutes.
- HOURS** First two digits that are entered when setting the clock.
- MINUTES** The last two digits that are entered when setting the clock.

Captions Caption/Text

Turns on and selects closed-captions and text options that appear on-screen

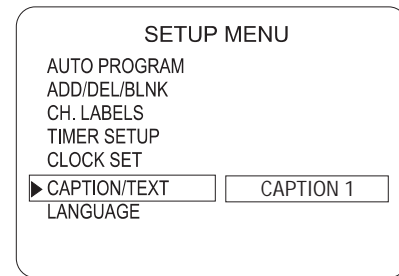

- 1** In the Setup menu using SELECT on the remote control, select Captions/Text on the screen.
- 2** Use the Right/Left ADJ arrows to choose any of the following options: Off, Caption 1, Caption 2, Caption 3, Caption 4, Text 1, Text 2, Text 3, or Text 4.
- 3** Press ENTER to remove menu.
- 4** Select Captions directly by pressing CC repeatedly to choose: Off, Caption 1, 2, 3, 4, or Text 1, 2, 3, 4.



Standard closed captioning is available using the Caption 1 option.



Not all programming has closed captioning or text available.

Caption/Text is a feature which allows the TV to receive the closed caption and/or text options if made available by the broadcaster.
Availability and functionality of Caption/Text features is determined only by each broadcaster and may not be available in your area.

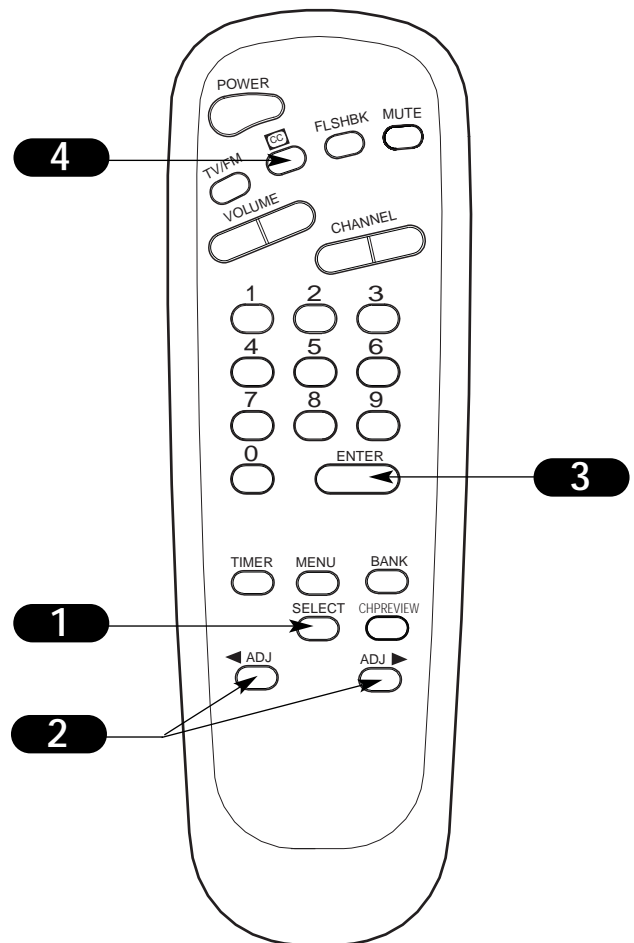

Mini glossary

CAPTIONS The term for the words that scroll across the bottom of your TV screen; usually the audio portion of the program provided for the hearing impaired.

TEXT The term for the words that appear in a large black frame and almost cover the entire screen; usually messages provided by the broadcaster.

Choose the language for the on-screen menus

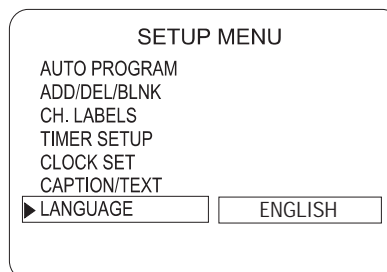

- 1** Press the MENU key on the remote control so the Setup menu appears.
- 2** Press SELECT on the remote control and repeat, to highlight Language on your screen.
- 3** Press a Right/Left ADJ arrow to choose one of the following options: English, Spanish or French.
- 4** Press ENTER to return to TV viewing.

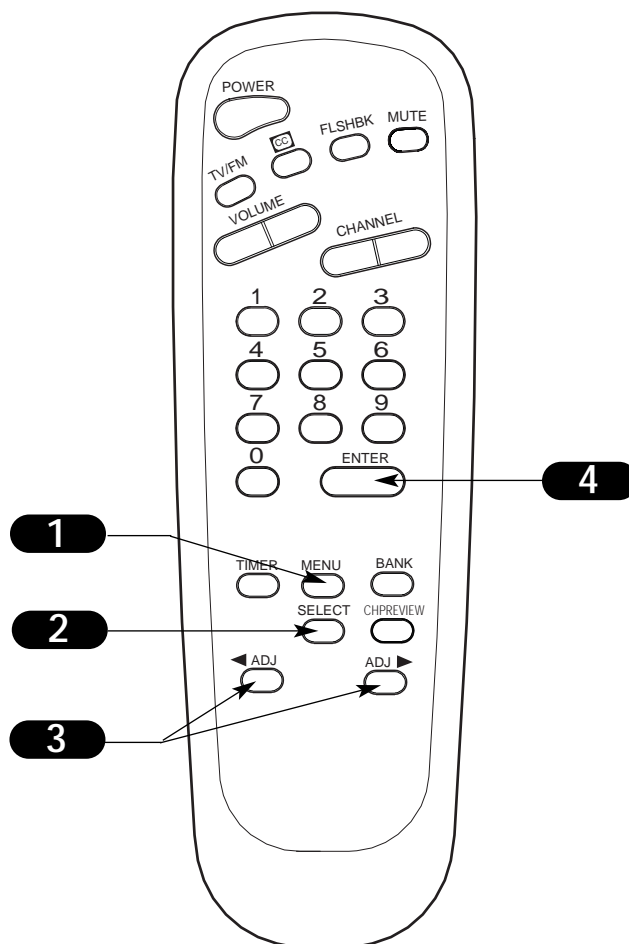

Audio Menu

Adjust the audio options for the guest

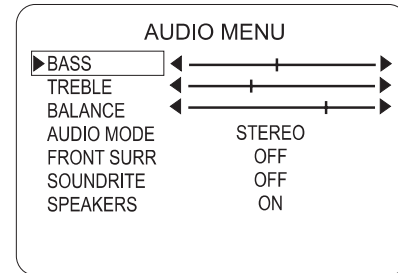

1 Press MENU repeatedly on the installer's remote control until the Audio menu appears.

2 Using SELECT on the remote control, highlight the setting you want to change. Choose from:

- **Bass:** Increases/decreases lower-end sounds.
- **Treble:** Increases/decreases higher-end sounds.
- **Balance:** Allows you to put the sound more to the left or right channel.
- **Audio Mode:** Chooses from Stereo sound, Mono, or 2nd Audio/SAP.
- **Front Surround:** Turns Front Surround sound on or off.
- **Soundrite:** Turns the uniform volume feature on or off.
- **Speakers:** Turns the TV speakers on or off.

3 Press a Right/Left ADJ arrow to adjust or change the option you have selected.

4 Press ENTER to return to TV viewing, or press SELECT and return to the Audio Menu to adjust another option.



Not all programming is broadcast in stereo sound or has 2nd Audio SAP.

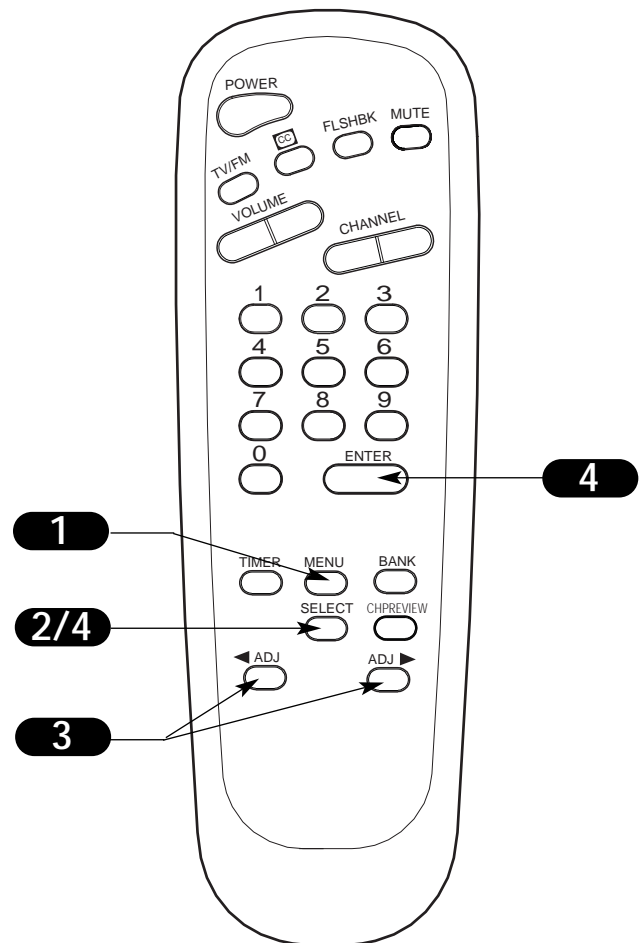

Mini glossary

STEREO SOUND	Stereo (stereophonic) sound refers to audio that's divided into right and left sides.
MONO SOUND	Mono (monaural) sound is one channel of sound. On more than one speaker, all the speakers play the same audio.
SOUNDRITE	Maintains a constant volume level when commercials or channel changing increases or decreases the sound level.

Use the Video menu to customize the picture

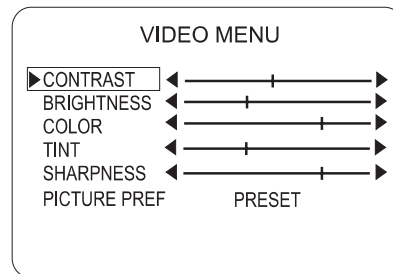

1 Press MENU repeatedly until the Video menu appears. Your options are:

- **Contrast:** Adjusts the level of difference between white and black in the TV picture. The more contrast, the brighter the picture appears.
- **Brightness:** Increases or decreases amount of white in the TV picture.
- **Color:** Adjusts levels of all colors in the TV picture.
- **Tint:** Balances between amounts of red and green in the TV picture.
- **Sharpness:** Raises or lowers the definition of the TV picture. The lower the level, the softer the images will appear.
- **Picture Preference:** Choose either Custom or Preset. Custom allows you to set the picture the way you want. Preset moves all the above options back to their original, factory-set levels.

2 Use SELECT on the installer's remote control, choose Contrast on your screen.

3 Use a Right/Left ADJ arrow, change the contrast level to your preference.

4 Press ENTER, or MENU one more time to return to TV viewing, or repeat from step two to set the other menu options.

5 Use SELECT to choose Picture Preference on your screen.

6 Use the Right/Left ADJ arrows, to choose either the original settings with Preset, or use your own settings with Custom.

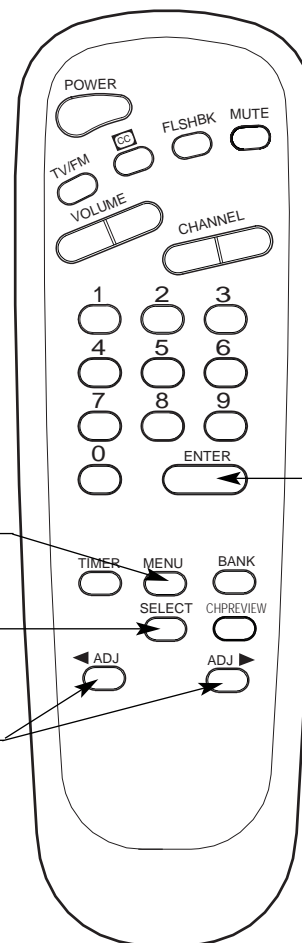

Choose the Preset option in Picture Preference to quickly reset the levels to their original values.

If used, this optional feature can “block” undesirable programming from appearing on the TV

Parental Control offers the user a wide variety of options and settings that restrict or “block” the programming that can appear on the TV. Parental control allows the user the capability of defining which program rating they consider acceptable, to the younger or more sensitive viewer. It can be preset and turned either on or off by the user who specifies the secret 4-number code, the password. The number of hours blocked are specified. General audience and children viewer blocks should both be programmed into the TV's memory. Viewer ratings are specified for both TV and the motion picture industry; both rating systems can be used. The ratings are based mainly on the ages of children.

Overview

To insure complete coverage for all TV programs, (movies and regular TV shows) choose a rating for MPAA, from the selections below AND choose ratings from the TV Parental Guidelines Rating System on pages 41 and 42, using the Age Block option for General Audiences, and for Children. In addition to those, you may wish to add additional restrictions from the Content Block menu. See the Parental Control menu, and submenus example on the next page.

Things to Consider before Setting Up Parental Control

Determine which rating you consider acceptable to the viewer. (For example, if you choose TV-PG, all more restrictive ratings will be automatically blocked; the viewer will not be able to see: TV-PG, TV-14, or TV-MA rated programming.)

Do you want the auxiliary video source signal blocked? (Block the picture and sound of the equipment, such as a VCR, connected to the TV Audio/Video input jacks; in the Aux. Block option.) Or leave unblocked, and Parental Control will restrict the video input based on the restrictions you have specified.

Block program “Content” based on individual parameters such as: Strong Dialog, Bad Language, Sex Scenes, Violence Scenes, or Fantasy Violence Scenes; in the Content Blk option.

How many hours do you want Parental Control to be active? You can set the option for up to 12 hours. (See next page.)

Select a secret password; in the Set Password option. Use the number keys on the remote. If you forget the password, see note below.

Do you want Parental Control to be active all the time? If not, you can turn it on or off; with the Lock On/Off option.



You should set different Parental Control viewing restrictions for general audiences and for children - - both should be active at the same time.



If you choose to have the Aux inputs unblocked, the ratings you specify will automatically restrict the programming that appears from the video sources.



Simply specifying one content block such as Sex Scenes, will not automatically block another content in the programs from appearing.



You cannot disable Parental Control by disconnecting the TV from power. Block hours will automatically reset to the original block time setting specified if power is disconnected.

Notes

Reset Parental Control Block Hours to Zero and Cancel Password

This provides the lodge staff and the installer a means to reset the TV to normal operation, if a guest has either forgotten the password or has left Parental Control Block active after checking out.

On the installer's remote control, press and hold down MENU until the menu disappears (about 6 seconds).

Immediately press 9, 8, 7, 6 and then CC.

This will reset the Block Hours to Zero and cancel the current 4-number password.

Installer Parental Control Menu

After you have read the preceding page, follow instructions below to set up and activate Parental Control

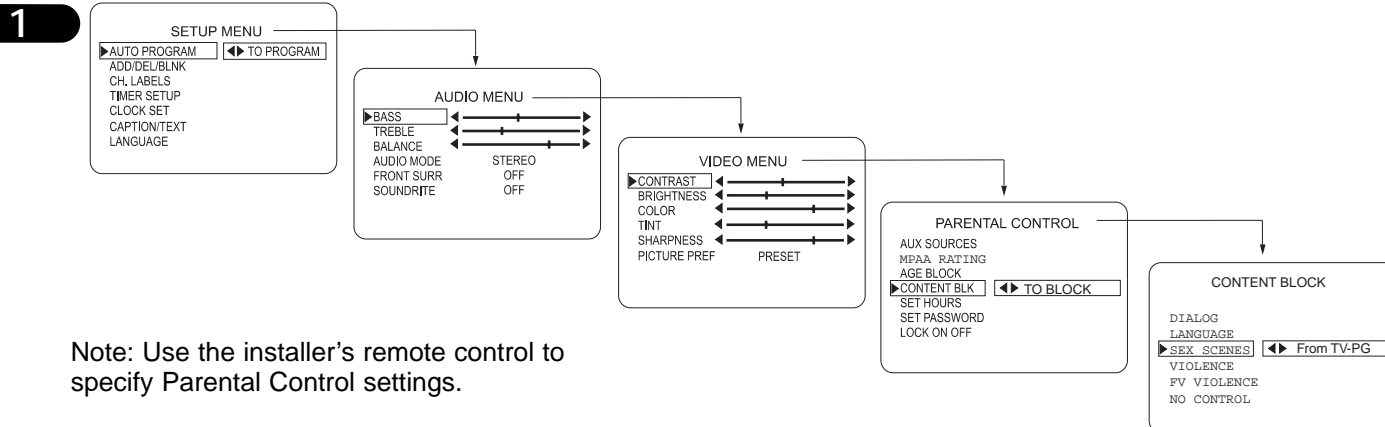

Note: Use the installer's remote control to specify Parental Control settings.

2 As shown above, with the Parental Control menu on-screen, use SELECT to choose an option, like Content Block.

3 Use the Left/Right ADJ arrow to show the Content Block menu, to adjust or set the rating for an option. For Sex Scenes for example, use the "From TV-PG" setting. (See the Mini Glossary, Ratings Charts on pages 41 and 42 for rating meanings.)

4 After you have selected and adjusted the parental control menu options to your preferences:

- Set the number of hours Parental Control will be on.
- Set a 4-number password.
- Set the Lock On/Off option to either on or off.

Note: Some broadcasts and videotapes do not include rating information.

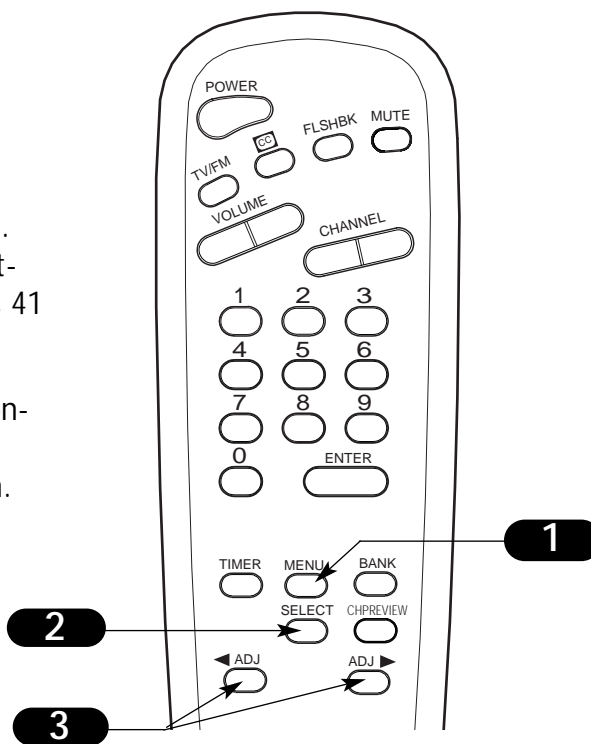

Notes

Reset Maximum Number of Parental Control Default Block Hours

You can change the Block hours from the 12-hour default setting to up to 99 hours.

In the Service Menu, item:

49 MAX BLK HRS 12, use the Left/Right adjust arrow to set a different default number of hours.

To Turn the Parental Control Feature Off/On

In the Service Menu, item:

53 V-CHIP 0 or 1,

use the Left/Right adjust arrow to set to 0, Parental Control will be disabled.

use the Left/Right adjust arrow to set to 1, Parental Control will be on.

Other Menus & On-Screen Displays

Press the remote keys indicated below to access these menus and displays

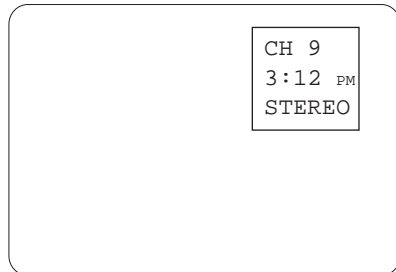

Channel/Time/Audio Display

Press ENTER. Shows currently selected channel or source, current time if the clock has been set, and incoming audio signal.

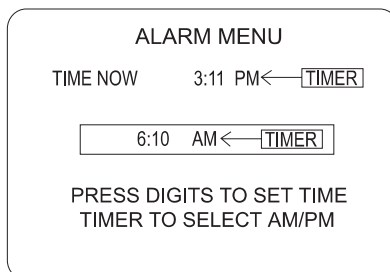

Alarm Menu

Press ALARM. Sets the time the wake up alarm will sound.



Sleep Timer Menu

Press TIMER. Sets the time to automatically turn the TV off and shows remaining time before TV shutoff.

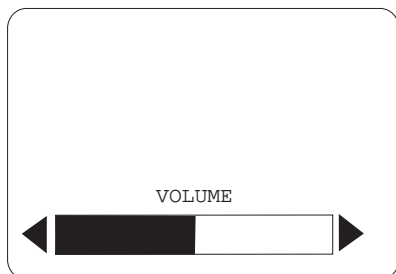

Volume Display

Press VOLUME. Shows currently selected sound setting.



Closed Captions Menu

Press CC. Sets Caption/Text options: Off, Caption 1, 2, 3, 4, or Text 1, 2, 3, 4.

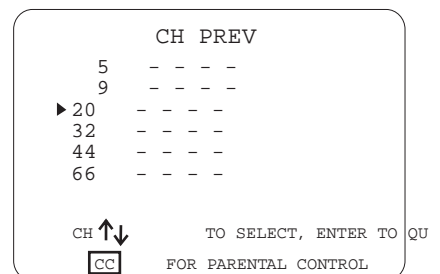

Ch Preview Menu

Press CH PREVIEW. Displays list of the available TV Channels, Guest Parental Control menu (if active) and Video Channel access. Press CHANNEL Up/Down to select a channel, or menu, then ENTER to go to channel or menu.



Channel Banks Menu

Press BANK. Accesses the Channel Banks menus: Bank 1, Bank 2, Bank 3, Bank 4.

The TV has four channel banks, where the administrator or installer can store groups of TV channels

PLANNING THE CHANNEL BANKS

Generally, TV channels are grouped into "program packages" with terms that are proposed to the end user. The user then opts for a package. Below is an example of how TV channels may be grouped.

You may plan your package by using a chart like the one after the following page.

Remember, you can "blank" a channel for accommodating audio-only, such as an FM radio station or in-house communication.

Sometimes, only one or two channel banks may be needed. You may leave any unused bank with the channels entered during Auto Program; or, you may delete the channels. However, you may want to leave at least one channel in any unused bank. Then, if someone selects an "unused" bank, that channel will assure them that the TV is functional.

Note: Some channels from factory testing may be in the channel banks if you have not yet run Auto Program.

Channel Bank	Program package
1	Basic cable channels
2	Extended cable channels
3	Extended with premium channels
4	Other cable service options

(Grouping is provided as an example only.)

ADDING / DELETING CHANNELS

A previously prepared programming chart is helpful.

1. Run auto Program (in the Setup menu). The channels available in your cable/antenna will be entered in the channel banks 1, 2, 3, and 4.

Note: Channels previously "blanked" will be cleared; channels entered that are not currently available, will be deleted.

2. Select a channel bank with an installer remote - -press SOURCE/BANK (and repeat). CHANNEL BANK and BANK number will be displayed.

3. Use the ADD/DEL/BLNK item (also in the Setup menu) to customize your program package. You may delete channels or add some that have not been entered. You can also "Blank" a channel for accommodating an audio-only program source or in-house communication. The "ADD/DEL/BLNK" item on pages has more details.

Note: The Blank Channel feature is global. A channel will be blanked in all channel banks.

4. Repeat steps 2, and 3 to program another channel bank.

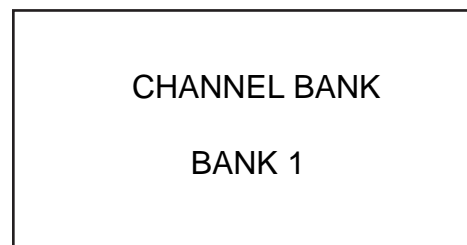

Channel bank number display



The BLNK (blank) channel function is "global" -- the same channel number is blanked in channel banks 1, 2, 3, and 4.

Managing the Channel Banks

Examples of typical channel banks charts filled in

Figure 1. Typical channel banks after running Auto Program

BANK	Purpose	Channel Number																								
		1	2	3	4	5	6	7	8	9	10	11	12	13	14	15	16	17	18	19	20	21	22	23	24	25
1			A			A		A		A					A	A	A	A	A	A	A		A	A	A	A
2			A			A		A		A					A	A	A	A	A	A	A		A	A	A	A
3			A			A		A		A					A	A	A	A	A	A	A		A	A	A	A
4			A			A		A		A					A	A	A	A	A	A	A		A	A	A	A

A = Active - - Channel was found during AUTO PROGRAM

Figure 2. Typical channel banks after running Auto Program, and customizing with Add/Del/Blnk

BANK	Purpose	Channel Number																								
		1	2	3	4	5	6	7	8	9	10	11	12	13	14	15	16	17	18	19	20	21	22	23	24	25
1	Basic	BC	A			A		A		A				D	D	D	D	D	D	D		D	D	D	D	
2	Extend	BC	A			A		A		A				A	D	A	A	D	A	A	A		D	D	D	D
3	All CTV	BC	A			A		A		A				A	D	A	A	D	A	A	A		A	D	A	A
4	Other	BC	A			A		A		A				A	A	A	A	A	A	A	A		A	A	A	A

A = Active Channel was found during AUTO PROGRAM
 D = Deleted Channel was deleted using Add/ Del option.
 BC = Blanked Channel Channel was blanked using BLANK channel option (ADD/DEL/BLNK).

ADDING / DELETING CHANNELS

It is best to do ADD / DEL customizing before doing "BLNK."

AUTO PROGRAM enters the same channels in banks 1, 2, 3, and 4.

AUTO PROGRAM removes any channels previously customized with ADD / DEL / BLNK. The channels available on your antenna / cable will be entered, and any channels previously entered but not currently available will be deleted.

ADD and DEL (not BLNK) can be used independently for channel banks 1, 2, 3, and 4.

A channel blanked, is blanked in all channel banks.

Channel allocations in tuning bands:

BROADCAST: 2 – 69

CABLE – CATV, HRC or ICC: 1 – 125

Managing the Channel Banks

PLAN YOUR CHANNEL BANKS BY FILLING IN THESE CHARTS (or use photocopies)

BANK	Purpose	Channel Number																								
		1	2	3	4	5	6	7	8	9	10	11	12	13	14	15	16	17	18	19	20	21	22	23	24	25
1																										
2																										
3																										
4																										

BANK	Purpose	Channel Number																								
		26	27	28	29	30	31	32	33	34	35	36	37	38	39	40	41	42	43	44	45	46	47	48	49	50
1																										
2																										
3																										
4																										

BANK	Purpose	Channel Number																								
		51	52	53	54	55	56	57	58	59	60	61	62	63	64	65	66	67	68	69	70	71	72	73	74	75
1																										
2																										
3																										
4																										

BANK	Purpose	Channel Number																								
		76	77	78	79	80	81	82	83	84	85	86	87	88	89	90	91	92	93	94	95	96	97	98	99	100
1																										
2																										
3																										
4																										

BANK	Purpose	Channel Number																									
		101	102	103	104	105	106	107	108	109	110	111	112	113	114	115	116	117	118	119	120	121	122	123	124	125	FM
1																											
2																											
3																											
4																											

Installer menus

Use the Installer menus to make adjustments

Accessing the Installer menu

Installer menus can be accessed by using the installer's remote control. Just press and hold MENU (about 8 seconds) until the display changes, then press 9, 8, 7, 6, then ENTER. To exit the Installer menu, press ENTER again. *Any changes you make will be stored in nonvolatile memory.*

The Installer menu opens with item 03, VERT POS. Press the Up/Down arrow keys to sequence through the various items. Or, access an item directly by entering the line number, then pressing MENU. For example, to access the Start channel/volume feature which is on line 11, press 11, then MENU. To change a current setting use the Left/Right ADJ keys.

Using the Installer menu

Items 00-22 are immediately accessible only upon entering the Installer menu. Their numbers, descriptions, ranges, factory default settings, and a place for listing any changes made on-site are given below. A second section of the Installer menu that is intended for qualified service technicians only is not shown (items 23-52). Normally these items do not require adjustment.

Items in the Installer menu:

Item	Description	Range	Fact. Set	Recommend. Setting
00	FACT MENU	0 - 1	0	Leave default set 0
01	PRESET PX	0 - 1	1	
02	POWER MANAGE	0 - 7	0	
03	VERT POS	0 - 30	15	
04	HORZ POS	0 - 45	29	
05	BAND/AFC	0 - 7	0	
06	MIN VOLUME	0 - 63	0	
07	MAX VOLUME	0 - 63	63	
08	AC ON	0 - 1	0	
9	KEY DEFEAT	0 - 1	0	
10	STRT CH/VOL	0 - 255	255	
11	HOSPITAL MODE	0 - 1	0	Leave default set 0
12	CHAN LOCK	0 - 1	0	
13	GHOST CH.	0 - 1	0	
14	SCAN MODE	0 - 3	0	Leave default set 0
15	TEXT MODE	0 - 1	1	
16	SLEEP TIMER	0 - 1	1	
17	ALARM	0 - 1	1	
18	CH. OVER RIDE	0 - 1	1	
19	OLD OCV	0 - 1	0	Set to 1 for old Spectramate systems
20	CAPTION LOCK	0 - 1	0	
21	FUNCTION PRE	0 - 1	0	
22	FEATURE LEVEL	0 - 1	1	Leave default set 1

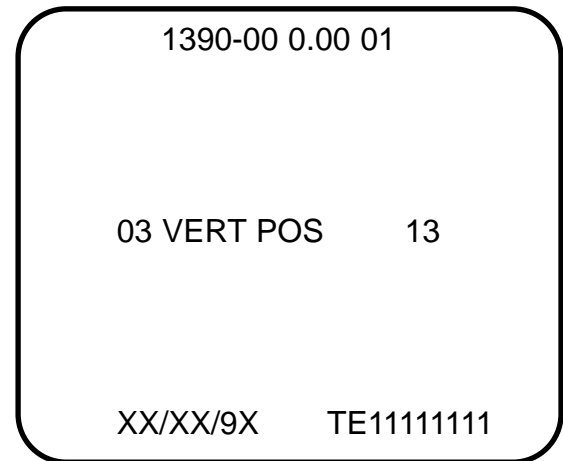

Installer should leave item 1 FACT MODE set to 0 (default). Items 23-52 are service-type adjustments and only qualified technicians having specialized test equipment should access them.

Use the Installer menus to make adjustments

00 FACT MENU (Factory Mode)

Used to access and customize Installer menu settings using the installer type remote.

01 PRESET PX (Preset Picture)

Saves your custom video settings (color, tint, contrast, and brightness) in nonvolatile memory (not affected by power loss). Memory status is indicated by a 1 for "custom settings already stored," or 0 for "custom settings have not been stored."

Make all custom video settings before you access the Installer menu and PRESET PX. When you use the ADJUST keys to toggle from 1 - 0, any changes in the video settings will be stored sure they are correct! These settings become the PRESET values for the PICTURE PREF option of the Video Menu. (For more information refer to the Video Menu section of this manual.)

02 POWER MANAGE (Power Management)

The POWER MANAGE function is for saving energy. When set to 0, Power Manage is OFF. Settings range from 0 - 7, with 1 - 7 representing the hours that the TV will remain on, unless there has been activity from either the control panel or remote. One minute before turning off, the message "PRESS ANY KEY TO KEEP TV ON" appears.

03 VERT POS (Vertical Position)

Moves captions and displays vertically on the screen. Use the ADJUST keys. Typical value is 15. Black bars top and bottom define the active screen area.

04 HORZ POS (Horizontal Position)

Moves captions and displays horizontally on the screen. Use the ADJUST keys. Typical value is 29. Black bars top and bottom define the active screen area.

05 BAND/AFC (Band/Automatic Frequency Control)

There are 8 possible settings for this option:

0 = Broadcast Fixed 4 = Broadcast AFC

5 = CATV Fixed 1 = CATV AFC

6 = HRC Fixed 2 = HRC AFC

7 = ICC Fixed 3 = ICC AFC

Channels are accessed faster when fixed modes are used. The AFC (search modes) should only be used when some channels are not on nominal frequencies. NOTE: BAND is automatically set by AUTO PROGRAM.

If some channels were not found by AUTO PROGRAM, select the appropriate AFC setting here and add the channels using the ADD/DEL option in the Setup Menu.

06 MIN VOLUME (Minimum Volume)

This function determines the minimum volume level allowable with the VOLUME (VOL) Up/Down control. In this way, for example, someone cannot set the volume too low to hear. The range is from 0 to 63—change values with ADJUST . The factory default is 0, which provides full range of volume control. It may be best to set the same value on every TV. NOTE: The minimum volume level cannot have a value setting higher than in the MAX VOLUME level (described below).

07 MAX VOLUME (Maximum Volume)

This function determines the maximum volume level allowable with the VOLUME VOL Up/Down control. In this way, for example, someone cannot set the volume level high enough to disturb others. The range is 0 to 63, with 63 as the default which gives the patient the full range of volume control. Change values with ADJUST keys. It may be best to set the same value on every TV. NOTE: The maximum volume level cannot have a value setting lower than the MIN VOLUME level (described above).

08 AC ON (AC Power Switchable)

Allows the TV to turn ON just by applying AC power. Pressing the ON button is not necessary. This is desirable when the TV is plugged into a cable box or a power outlet controlled by a wall switch. Use ADJUST to select 0 or 1, where 0 is the default is OFF, and 1 is ON.

NOTE: When set to 1 (ON), the TV does not respond to ON/OFF commands from either the remote or the control panel, and the SLEEP TIMER is also nonfunctional.

9 KEY DEFEAT (Keyboard Defeat)

When set to 1, it prevents the end user from accessing screen menus on the front panel—MENU, SELECT, and ADJUST do not function. When set to 0, those keys are functional. The menus can always be accessed with MENU on the remote.

10 STRT CH/VOL (Start Channel/Volume)

When active, this function allows you to determine the initial volume level setting and channel number when the TV is turned ON. This feature is useful for an in-house information channel, since the TV would always select that channel when it is turned on. When inactive, the volume level and channel retain the settings when the set was last used.

Use the Installer menus to make adjustments

The range of values is 0 - 255. Use (adjust) keys to choose: (1) With number 255 the feature is inactive. (2) Other numbers determine the start channel. (3) Set the volume level as desired before exiting the Installer menu. 0 is the "AUX" channel.

11 HOSPITAL MODE

Not used in Concierge-series TVs. Leave at default setting 0.

12 CHAN LOCK (Channel Lock)

When set to 1 the CHAN LOCK is ideal if a cable box (or similar) is the sole source for programming—and the TV must always be on the same channel. Changing channels with the Channel up/down or or keypad numbers is impossible. Channel Lock is inactive when set to 0 (default).

Generally, this feature is used in connection with START CHAN/VOL (line 11) where the start channel may, for example, be set to 3 or 4. If the start channel is 3 then the TV will remain on channel 3. NOTE: When channel lock is active AUTO PROGRAM and CH. ADD/DEL in the SETUP MENU are not active.

13 GHOST CH. (Ghost Channel)

When set to 1, the current channel number is displayed in the upper right corner of the CRT. The number moves slightly to prevent damage to the screen. The default is "0" or OFF. NOTE: When captions are on, the "ghost channel" is not displayed.

14 SCAN MODE

Allows variation in setting the On/Off with Channel UP/DOWN. You may opt for TV channels only; TV channels + Off/ON; TV channels + FM radio; TV channels + FM radio + Off/On with these settings for Scan Mode:

Scan mode	Characteristics
0	Channel up/down keys change channels only.
1	Channel down below the lowest channel (or channel up higher than the highest) and TV turns off.
2	Channel Up/Down + FM.
3	Channel Up/Down + Off/On.

15 TEXT MODE

Determines whether TEXT 1, TEXT 2, TEXT 3, or TEXT 4 decoding is enabled when TEXT is turned on (either from the Setup Menu or directly with CC on the remote).

TIP: Set Text Mode to 1 only if text is offered in your video system.

16 SLEEP TIMER

When set to 1, the SLEEP TIMER feature may be used (but no message is displayed prior to turn-off). When set to 0, the sleep timer is not available.

17 ALARM

Gives you the option of making the alarm function available to the end-user. Set to 1, alarm function is available. Set to 0 to withhold this function. The clock must be set in order to use the alarm.

18 CH. OVERRIDE (Channel Override)

When set to 1, the user is allowed to select channels with either Channel up/down or by direct keypad entry. When set to 0, only those channels that are entered for scanning may be selected.

19. OLD OCV (On Command Video™)

Set to 1 for operation with "SpectraMate" systems from On Command Corporation.

20. CAPTION LOCK

Set to 1 to restore previous caption On/Off state after TV turns off when set to 0, captions are always off when TV is initially turned on.

21. FUNCTION PRE

Set to 0 to suppress CHANNEL PREVIEW FUNCTION menu with some pay per view systems.

22. FEATURE LEVEL

Set to ZEN 1 for Zenith compatible remote control operation, set to 0 for PLbl for Zenith private label compatible remote control operation.



Some of the functions shown above may not be available on your TV (such as FM).

Use the LT1500 QuickSet Programmer to duplicate the TVs setup

The optional QuickSet II Programmer (LT1500) allows custom setup and programming information to be quickly copied from a master TV into multiple television sets. Once learned from the master, setup data is retained in the LT1500 for future use and recall.

When using the LT1500, operation will be easier if the TV set is connected to a good quality signal and operating with a stable picture displayed. To operate the LT1500, use the indicated keys on an HP602, LP702, or MBR3447 remote, or the front panel keys on the TV receiver.

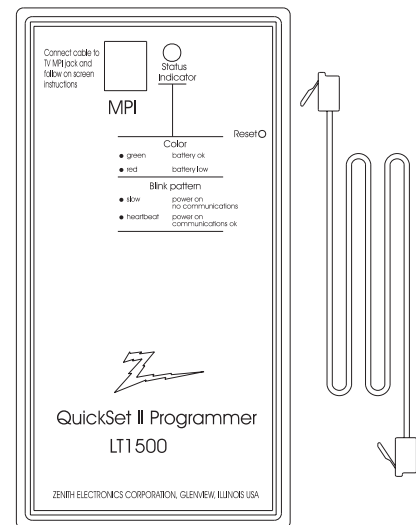

- 1 Set up a master TV set using your remote and following the instructions in this operating guide. Set all features you wish to customize including the channel scan list, channel labels, and service menu setups.
- 2 Connect the LT1500 to the master TV set using the cable provided with the programmer. Connect the cable between the MPI jack on the TV and the programmer. Connecting the programmer to the TV set automatically activates the programmer power-switching circuits.
- 3 Once connected, check the "Status Indicator" LED on the programmer. The indicator should be flashing a green double-blink "heartbeat" pattern.

If communications are good, the sign-on screen will be displayed on the TV screen as shown on the quick setup instructions which accompany the LT1500. If you intend to set the TV or programmer real-time clocks, note the clone clock and TV clock time settings, then press a key to proceed to the main clone menu.

If you have previously stored a TV setup in a particular clone memory, it may be changed if desired by overwriting it with a new setup. There is no need for a separate memory clear operation.

Item 1: Learn From TV

Setups stored in programmer memory are nonvolatile and will be retained even after a battery change.

- 1 Press (1) then ON/OFF, POWER, or ENTER to begin the learning process. Alternatively, use the TV front panel CHANNEL UP or CHANNEL DOWN keys to highlight your choice, then press ON/OFF, POWER, or ENTER to activate.
- 2 The next screen will allow you to choose which of the available memories will be used to store this TV setup. With four memories available, four different TV setups can be stored in the LT1500.
- 3 Using the on screen menu, choose a memory or choose to return to the main selection menu, then press ON/OFF, POWER, or ENTER to activate the selection.
- 4 The next screen gives you one last opportunity to check the versions of TV and clone setups. Press ON/OFF, or POWER to activate the learning cycle or any other key to return to the selection menu to make other choices.
- 5 Once the process has begun, the TV screen will display the "LEARNING IN PROGRESS" message. Please wait until the process is completed. When the TV screen displays "LEARNING COMPLETED", press any key to end the learning process and return to the clone selection menu.



A slow flashing green light indicates there is a problem with the communications between the TV and the programmer. In this case, check for a damaged cable, poor contacts, or other connection troubles.



If the status indicator is red, the programmer batteries are low and should be replaced. Use 4 good quality alkaline AA batteries.

Clone Selection Menu Choices

Use the LT1500 QuickSet Programmer to duplicate the TVs setup

Item 2: Teach the TV

- 1 Press (2) then ON/OFF, POWER, or ENTER to begin the teaching process. Alternatively, use the TV front panel CHANNEL UP or CHANNEL DOWN keys to highlight your choice, then press ON/OFF, POWER, or ENTER to activate.
- 2 The next screen will allow you to choose which of the 4 available memories will be copied to this TV.
- 3 Press the desired memory number, then ON/OFF, POWER, or ENTER to begin the teaching process. Alternatively, use the TV front panel CHANNEL UP or CHANNEL DOWN keys to highlight your choice, then press ON/OFF, POWER, or ENTER to begin.
- 4 Using the on screen menu, choose a memory or choose to return to the main selection menu, then press ON/OFF, POWER, or ENTER to activate the selection.
- 5 The next screen gives you one last opportunity to check the versions of TV and clone setups . Press ON/OFF, or POWER to activate the teaching cycle or any other key to return to the selection menu to make other choices.
- 6 The TV screen will display the "TEACHING IN PROGRESS" message. Please wait until the process is complete. When the TV screen displays "TEACHING COMPLETED", press any key to return to the clone selection menu.

Item 3: Set Clone Clock From TV

- 1 To initially set the real time clock in the LT1500 or update the time, press (3), then press ON/OFF, POWER, or ENTER to copy the current TV time to the clone clock. Alternatively, use the TV front panel CHANNEL UP or CHANNEL DOWN keys to highlight your choice, then press ON/OFF, POWER, or ENTER to activate.
- 2 This process will return you to the sign-on screen to display the clone and TV clock settings. You may press a key to go to the clone selection menu and perform other functions, or simply disconnect if time setting was your only task.

Item 4: Set TV Clock From Clone

- 1 To set the real time clock in the TV, press (4), then press ON/OFF, POWER, or ENTER to copy the current clone time to the TV clock. Alternatively, use the TV front panel CHANNEL UP or CHANNEL DOWN keys to highlight your choice, then press ON/OFF, POWER, or ENTER to activate.
- 2 This process will return you to the sign-on screen to display the clone and TV clock settings. You may press a key to go to the clone selection menu and perform other functions, or simply disconnect if time setting was your only task.

Item 5: Display TV Setup

- 1 Press (5) then ON/OFF, POWER, or ENTER to begin the teaching process. Alternatively, use the TV front panel CHANNEL UP or CHANNEL DOWN keys to highlight your choice, then press ON/OFF, POWER, or ENTER to activate.
- 2 The TV screen will display the items in the Installer menu setups for you to observe. Use this function to quickly check a TV for the correct setup.
- 3 Press any key to clear the display and return to the clone selection menu.

Use the LT1500 QuickSet Programmer to duplicate the TVs setup

Item 6: Display Clone Setup

- 1 Press (6) then ON/OFF, POWER, or ENTER to begin the teaching process. Alternatively, use the TV front panel CHANNEL UP or CHANNEL DOWN keys to highlight your choice, then press ON/OFF, POWER, or ENTER to activate.
- 2 The TV screen will display the memory selection menu.
- 3 Press the desired memory number, then ON/OFF, POWER, or ENTER to display the contents of the selected memory. Alternatively, use the TV front panel CHANNEL UP or CHANNEL DOWN keys to highlight your choice, then press ON/OFF, POWER, or ENTER to begin.
- 4 The TV screen will display the items in the Installer menu setups for you to observe. Use this function to quickly check the contents of a particular clone memory for the correct setup.
- 5 Press any key to clear the display and return to the clone selection menu.

Operation Notes

Disconnect the LT1500 from the TV set when you have completed the desired task. Disconnecting the clone automatically switches it off. The real-time clock continues to run when the main circuits are switched off.

After replacing exhausted batteries, or if the programmer behaves strangely after a static shock, use a paper clip or similar instrument inserted through the small hole marked "RESET" to activate the internal reset switch and restore normal operation. After a reset, check the real-time clock setting. It may be necessary to reset the clock from a TV containing the correct time.

The LT1500 programmer is designed to be used with TV sets containing the 221-01006 and later processors. Use with earlier TV sets may give unpredictable results. The specific microprocessor used in any TV set may be determined by activating the Installer menu. The microprocessor part number appears at the top of the screen when the Installer menu is activated. Processors before the 221-01006-04 have a limited screen display capability. They can not display entire screens as shown in the quick setup instructions accompanying the LT1500 programmer. Use the printed menu illustrations on the quick setup sheet as an aid to making your programming choices.



When cloning operations are complete, just unplug the LT1500 for the TV set.



If the TV does not display a picture (blank screen) after a few seconds, just change channels.

Routine TV cabinet and screen cleaning

Careful and regular cleaning can extend the the useful service life of the TV. Be sure to turn the power off and pull out the plug before you begin any cleaning.

Screen Cleaning

1. Here's a great way to keep the dust off the screen for a while. Wet a soft cloth in a mixture of lukewarm water and a little fabric softener or dish washing detergent. Wring the cloth until it's almost dry, and then use it to wipe the screen.
2. Make sure the excess water is off the screen, and then let it air-dry before turning it on.

Cabinet Cleaning

1. Use a soft cloth with a mild soap solution to wipe the cabinet. (Avoid using any harsh, industrial strength variety of cleaner.)
2. Rinse the cloth and wipe the cabinet again.
3. Let the cabinet air-dry before turning the TV on.

Wood Cabinet

Use a quality wood cleaner and polish. This will protect the TV from dirt and dust, as well as keep the cabinet looking new.

Minimal Usage



If you leave the TV dormant for a long time, it's a good idea to unplug the power to protect against possible damage from lightning or power surges. If you use an off-air antenna, you may also want to disconnect it from the back of the TV.



If you unplug the TV, you may have to reset the clock using the Clock Set menu described earlier. See page 20.

Some quick and easy tips to resolving problems

SYMPTOMS	SOLUTIONS
Snowy picture and unclear sound.	<ul style="list-style-type: none"> • Check your antenna connection or location • Check your cable input. • Check to see if the TV/.VCR button on your VCR has the TV selected
Multiple images or 'ghost shadows.'	<ul style="list-style-type: none"> • Check your antenna direction and/or location. • Check your cable input • Make sure the cable from your antenna to your Entertainment Machine is properly connected.
Interference: Sharp lines across the screen and lousy sound.	<p><i>The following may cause image problems or distortion: Electrical appliances, powerful lights, cars, trucks; computers or portable phones; medical equipment</i></p> <ul style="list-style-type: none"> • If possible increase the distance between your Entertainment Machine and the offending appliance. Or shut one of them off.
Normal picture but no sound.	<ul style="list-style-type: none"> • Check volume levels. • Make sure the TV is not Muted. • Try another channel. The problem may be the broadcast, not your Entertainment Machine. • Are the Audio A/V cables properly installed? • Are the wires for external speakers (if you have external speakers) properly installed? • Make sure your speakers turned on under the Audio menu. • If your audio mode is set to SAP, that channel may not have a SAP program.
No picture and unclear sound.	<ul style="list-style-type: none"> • Are you in TV or cable tuning mode, and should be in the other? • Make sure output channels on all A/V equipment are on the same channel (3 or 4). • Check that all connections are tight.
No picture and no sound.	<ul style="list-style-type: none"> • Is the AC power plugged in? • Check that your AC power outlet works. (Test it by plugging in something else or try another plug.) • Make sure your brightness and audio controls are set properly. • Try another channel. The problem may be with the broadcast.
No color, but the sound is O.K.	<ul style="list-style-type: none"> • Check the color control in the Video menu. • Try another channel. The problem may be with the broadcast.
Picture has a big black box on it, but the sound is O.K.	<ul style="list-style-type: none"> • The CC (closed caption) option may be in Text mode. Select Caption 1, or OFF in the Captions/Text menu.
Remote control doesn't work.	<ul style="list-style-type: none"> • Make sure the batteries are fresh and installed properly.
Menu options can't be changed or selected.	<ul style="list-style-type: none"> • Make sure the battery on the single side (located on bottom right when remote transmitter is pointed toward the TV) is polarized properly (see page 10).
No picture or sound when any non-cable source is selected.	<ul style="list-style-type: none"> • Try unplugging the TV for a few minutes, then plug it back in.

A list of definitions for words found in this guide

75 OHM RF CABLE	The wire that comes from an off-air antenna or cable service provider. The end looks like a hex-shaped nut with a wire sticking through the middle. It screws onto the threaded jack on the back of the TV.
300 TO 75 OHM ADAPTER	A small device that connects a two-wire 300 ohm antenna to a 75 ohm RF jack. They are usually about an inch long with two screws on one end and a round opening with a wire sticking out on the other end.
A/V CABLES	Audio/Video cables. Three cables bunched together—right audio (red), left audio (white), and video (yellow). A/V cables are used for stereo playback of videocassettes and for higher quality picture and sound from other A/V devices.
A/V DEVICE	Any device that produces video or sound (VCR, DVD, cable box, or television).
ADD	This function lets you add new channels to list that you'll scroll through when using your remote.
AMPLIFIER	An electronic device that amplifies sound from a television, CD player, VCR, DVD or other A/V device.
ANTENNA	The physical receiver of television signals sent over the air. A large metal piece of equipment does not always have to be visible for your home to be using an antenna.
AUTO PROGRAM	Auto Program has the Concierge TV automatically find all the channels available in your area.
DELETE	Lets you remove channels from the list the guest will scroll through using the guest remote.
INPUT	Refers to the jack that receives a signal from a TV, VCR or other A/V device.
JACK	A connection on the back of a TV, VCR, or any other A/V device.
MONO SOUND	Mono (monaural) sound is one channel of sound. On more than one speaker, all the speakers play the same audio.
OUTPUT	Refers to the jack that sends a signal out of a VCR, DVD, or other A/V device.
2ND AUDIO PROGRAMMING/SAP	Second Audio Programming (SAP) is another, separate, audio channel Available with some programming. Choosing SAP often refers to listening to audio in another language, such as Spanish or French.
SIGNAL	Picture and sound traveling through a cable, or over the air, to your television screen.
STEREO SOUND	Stereo (Stereophonic) sound refers to audio that's divided into right and left sides.
TUNER	Device that picks up the signal and turns them into picture and sound.

Guest Remote Control Key Functions

A quick list of the keys on the guest remote and what they do

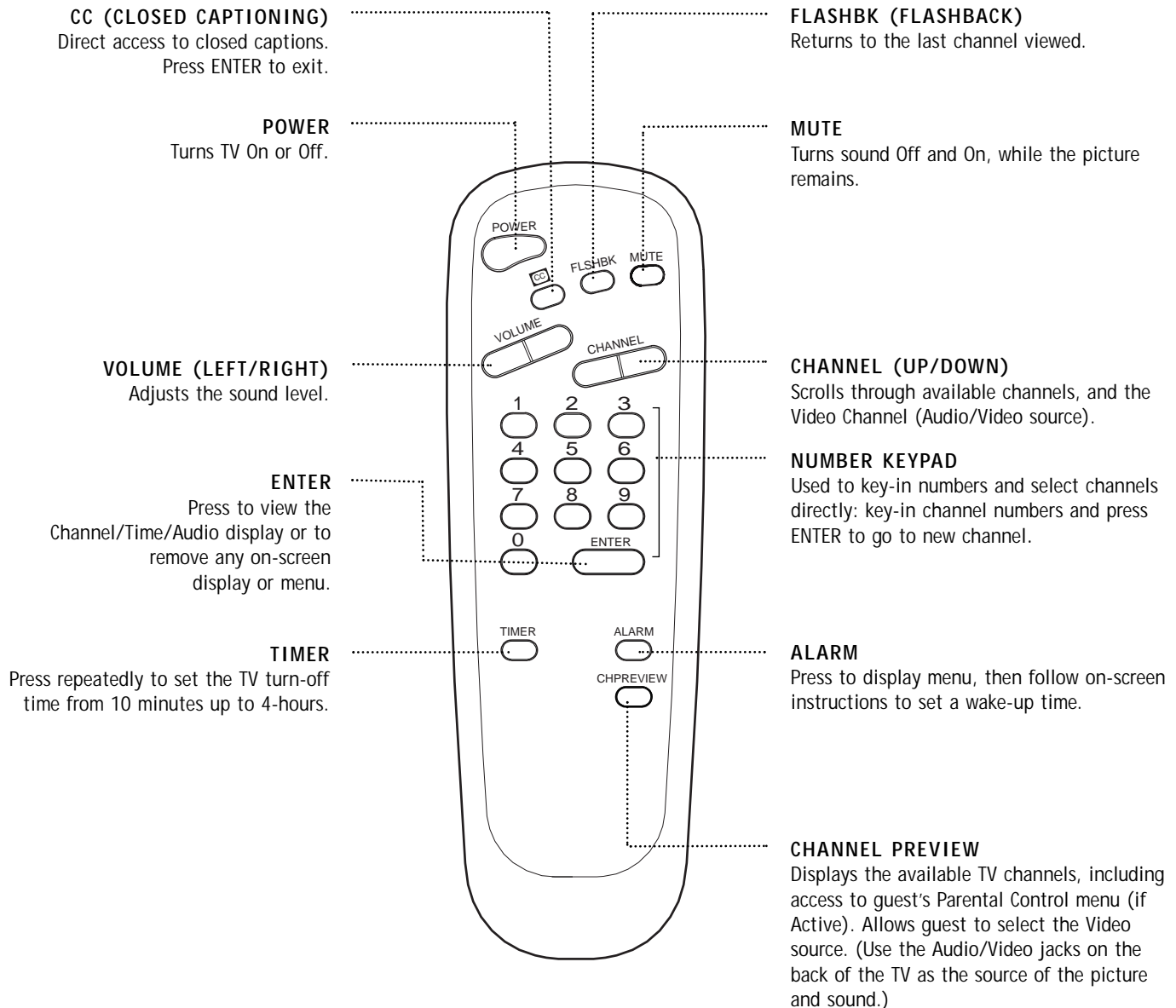

remote control part number
SC652
124-213-02

NOTE:

The channel and volume keys can be used by the guest to select and adjust the Parental Control settings, if the installer activates the Parental Control option in the Installer menus.

This optional feature can be used to "block" undesirable programming from appearing on the TV

This TV offers the user a wide variety of options and settings that restrict or "block" the programming that can appear on the TV. Parental control allows the user the capability of defining which program rating they consider acceptable, to the younger or more sensitive viewer. It can be preset and turned either on or off by the user who specifies the secret 4-number code, the password. The number of hours blocked are specified. General audience and children viewer blocks should both be programmed into the TV's memory. Viewer ratings are specified for both TV and the motion picture industry; both rating systems can be used. The ratings are based mainly on the ages of children.

Overview

To insure complete coverage for all TV programs, (movies and regular TV shows) choose a rating for MPAA, from the selections below AND choose ratings from the TV Parental Guidelines Rating System on the next page, using the Age Block option for General Audiences, and for Children. In addition to those, you may wish to add additional restrictions from the Content Block menu. See the Parental Control menu, and submenus example on the next page.

Things to Consider before Setting Up Parental Control

Determine which rating you consider acceptable to the viewer. (For example, if you choose TV-PG, all more restrictive ratings will be automatically blocked; the viewer will not be able to see: TV-PG, TV-14, or TV-MA rated programming.)

Do you want the auxiliary video source blocked entirely? (Block the content of the equipment, such as a VCR, connected to the TV Audio/Video input jacks; in the Aux. Block option.) Or leave unblocked, and Parental Control will restrict the video picture and sound based on the restrictions you have specified.

Block program "Content" based on individual parameters such as: Strong Dialog, Bad Language, Sex Scenes, Violence Scenes, or Fantasy Violence Scenes; in the Content Blk option.

How many hours do you want Parental Control to be active? You can set the Hours option for up to 12 hours.

Select a secret password; in the Set Password option. Use the number keys on the remote. Don't forget the password, it is the only way you can access the Parental Control menu and change rating selections, or turn Parental Control off.

Do you want Parental Control to be active all the time? If not, you can turn it on or off; with the Lock On/Off option.



You should set Parental Control viewing restrictions for general audiences and for children - - both should be active at the same time.



If you choose to have the Aux inputs unblocked, the ratings you specify will automatically restrict the programming that appears from the video sources.



Simply specifying one content block such as Sex Scenes, will not automatically block another content in the programs from appearing.



You cannot disable Parental Control by disconnecting the TV from power. Block hours will automatically reset to the original block time setting specified if power is disconnected.

Mini glossary

MOTION PICTURE ASSOCIATION OF AMERICA (MPAA) RATING SYSTEM

G	General Audiences	Content not offensive to most viewers.
PG	Parental Guidance Suggested	Content is such that parents may not want their children to view the program.
PG-13	Parental Guidance Suggested	Program is inappropriate for preteens, with a greater degree of offensive material than a PG rated program.
R	Restricted viewing	Not for children under age 17. Strong elements of sex and/or violence.
NC-17	Restricted Viewing	Not for children under age 17 under any circumstances. Strong sexual content.
X	Hard Core Films	Same as NC-17 rating.

Note: Zenith Electronics Corporation is not liable for any program content that appears when using this rating system; as always, user discretion is advised.

Guest Parental Control Menu

After you have read the preceding page, follow instructions below to set up and activate Parental Control

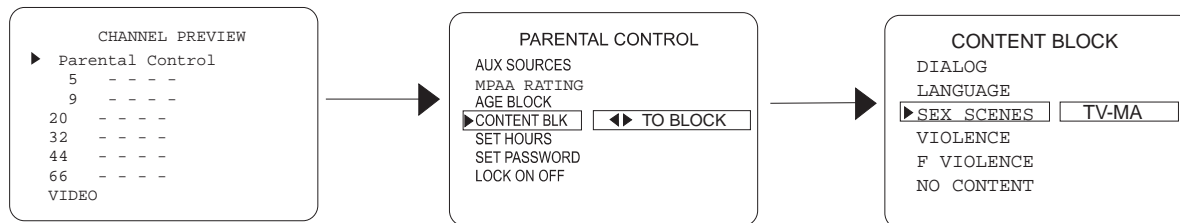

Note: The lodge decides if the Parental Control feature will be available to the guest. If available, Parental Control will appear as an option in the CH (CHANNEL) PREVIEW menu.

- 1** Press CH PREVIEW.
 - 2** Press CC to go to PARENTAL CONTROL menus.
 - 3** Use CHANNEL Up/Down to highlight an option like CONTENT BLOCK.
 - 4** Use VOLUME Up/Down to go to the CONTENT BLOCK menu.
 - 5** Use CHANNEL Up/Down to highlight an option like SEX SCENES.
 - 6** Use VOLUME Up/Down to choose: Unblocked, TV-PG AND ABOVE, TV-14 AND ABOVE, or TV-MA. (AND ABOVE means more restrictive headings are automatically included when you choose a low restriction setting like TV-PG.) See the Mini Glossary, Ratings Charts on this and the previous page for rating meanings.
 - 7** After you have selected and adjusted the parental control menu options to your preferences:
 - Set the number of hours Parental Control will be on.
 - Set a 4-number password.
 - Set the Lock On/Off option to either on or off.
 - 8** Press ENTER to remove menu.
- Note: some broadcasts do not contain rating information.

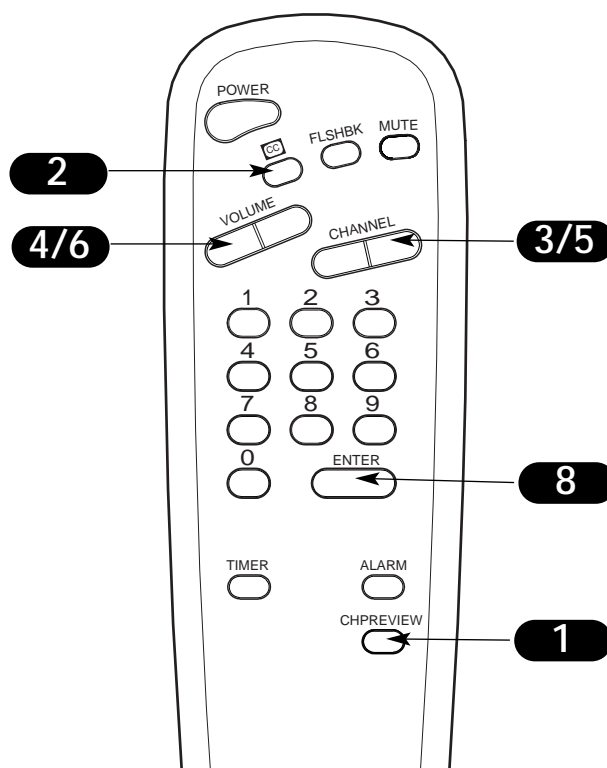

Mini glossary

TV PARENTAL GUIDELINE RATING SYSTEM

TV-G	General Audience	Considered suitable for all audiences; children may watch unattended.
TV-PG	Parental Guidance Suggested	Unsuitable for younger children, may contain: Suggestive Dialog, Bad Language, Sex, and Violence Scenes.
TV-14	Parents Strongly Cautioned	Unsuitable for children under 14, may contain: Strong Dialog, Bad Language, Sex, and Violence Scenes.
TV-MA	Mature Audience Only	Adults only, may contain: Strong Dialog, Bad Language, Sex, and Violence Scenes.

CHILDREN'S CLASSIFICATIONS

TV-Y	Children	Considered suitable for all children under 7 years old.
TV-Y7	Children 7 and over	Considered suitable for children over 7, may contain Fantasy Violence Scenes.

Press the remote keys indicated below to access these menus and displays

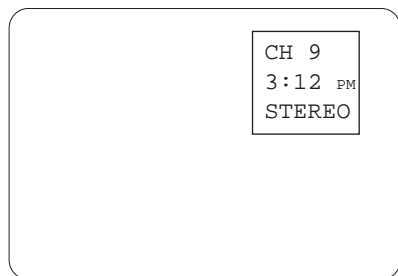

Channel/Time/Audio Display

Press ENTER. Shows currently selected channel or source, current time if the clock has been set, and incoming audio signal.

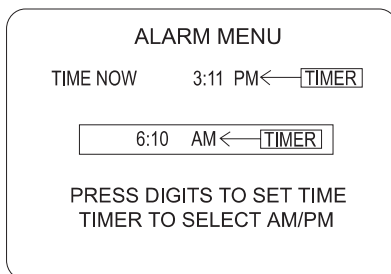

Alarm Menu

Press ALARM. Sets the time the wake up alarm will sound. Use number keypad and TIMER to set AM/PM.



Sleep Timer Menu

Press TIMER. Press repeatedly to set the Sleep Timer. Shows remaining time before TV shutoff.

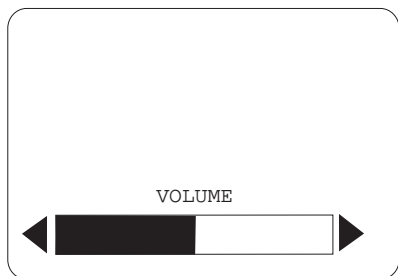

Volume Display

Press VOLUME. Shows currently selected sound setting.



Closed Captions Menu

Press CC. Shows Caption/Text options: Off, Caption 1, 2, 3, 4, or Text 1, 2, 3, 4.

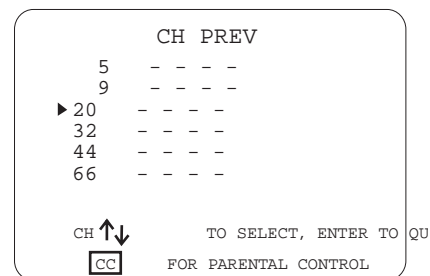

Ch Preview Menu

Press CH PREVIEW. Displays list of the available TV Channels, Guest Parental Control menu (if active), and Video Channel access. Press CHANNEL Up/Down to select a channel, or menu, then ENTER to go to the channel or menu.

Zenith Concierge™ Direct-View TV Receiver Warranty

Direct-View Color TV Welcome to the Zenith family! We believe that you will be pleased with your new Zenith TV. Please read this warranty carefully, it is a "LIMITED WARRANTY" as defined under Federal Law. This warranty gives you specific legal rights, and you may also have other rights that vary from state to state within the U.S.A.

ZENITH RESPONSIBILITY

- Service Labor** During a period of 1 year from effective warranty date, Zenith will provide service labor by a Zenith authorized service center when needed, as determined by the Zenith service center, as a result of manufacturing defects.
- Parts** New or remanufactured replacements for factory-defective parts will be supplied by a Zenith authorized service center for one year from effective warranty date (color picture tube — two years). Such replacement parts are warranted for the remaining portion of the original warranty period.
- In-Lodge Service** Warranty service for 21" diagonal (U.S.A.) or larger screen size models is provided in the lodge in most cases. (Some repairs may require the unit to be taken by the servicer to the repair facility and returned, at no additional charge.)
- Not Covered** This warranty covers manufacturing defects and does not cover installation, adjustment of customer controls, installation or repair of antenna systems, cable converters or cable company-supplied equipment; it also does not cover damage due to misuse, abuse, negligence, acts of God or other causes beyond the control of Zenith. Any alteration of the product voids this warranty in its entirety.

THIS WARRANTY IS IN LIEU OF ANY OTHER WARRANTY, EXPRESSED OR IMPLIED, INCLUDING WITHOUT LIMITATION, ANY WARRANTY OF MERCHANTABILITY OR FITNESS FOR A PARTICULAR PURPOSE, AND ZENITH SHALL NOT BE LIABLE FOR ANY CONSEQUENTIAL, INDIRECT, OR INCIDENTAL DAMAGES OF ANY KIND, INCLUDING LOST REVENUES OR PROFITS IN CONNECTION WITH THIS PRODUCT. SOME STATES DO NOT ALLOW LIMITATIONS ON HOW LONG AN IMPLIED WARRANTY LASTS OR THE EXCLUSION OR LIMITATION OF INCIDENTAL OR CONSEQUENTIAL DAMAGES, SO THE ABOVE LIMITATIONS OR EXCLUSIONS MAY NOT APPLY TO YOU.

OWNER'S RESPONSIBILITY

- Effective Warranty Date** Warranty begins on the date of the installation of the Commercial Products Direct View Television Receiver. For your convenience, keep the dealer's dated bill of sale or delivery ticket as evidence of the purchase date.
- Operating Guide** Read the Operating Guide carefully so that you will understand the operation of the TV and how to adjust the controls.
- Carry-In Service** Models under 21" diagonal (U.S.A.) screen size must be taken to a Zenith authorized service center for warranty service and must be picked up by the owner.
- Antenna** Reception problems caused by inadequate antennas or faulty antenna connections are the owner's responsibility.
- Important** Product Registration—Please fill out and mail the Product Registration Card. It is imperative that Zenith know how to reach you promptly if we should discover a safety problem that could affect you.
- Warranty Service** For warranty service information, contact any Zenith authorized service center. Parts and service labor that are Zenith's responsibility (see above) will be provided without charge. Other service is at the owner's expense. If you have any problem in obtaining satisfactory warranty service, call or write the Zenith Response Center. You must provide the model number, serial number and date of purchase or date of original installation. Before you ask for warranty service, read "Maintenance And Troubleshooting" in the operating guide. You might avoid a service call.

ZENITH ELECTRONICS CORPORATION
Zenith Response Center
201 James Record Rd., Building 3
Huntsville, AL 35824
Telephone (256) 772-1515
Mon-Fri, 7:00 a.m.-8:00 p.m. CST
Sat, 8:00 a.m.-5:00 p.m. CST
www.zenith.com

ZENITH CONSUMER SERVICES FACTORY OWNED SERVICE CENTERS

801 E. Roosevelt Rd.
Lombard, IL 60148
Telephone (630) 705-2830

Home & Carry-in Service
Television/VCR
Parts and Accessories
PTV/Camcorders

201 James Record Rd.
Building 4
Huntsville, AL 35824
Telephone (256) 774-4025
Service Hours:
M-F 8-6, Sat 9-2
Will accept UPS shipments

Additional Zenith Picture Tube Protection Plan Available

Zenith offers you the opportunity to obtain additional long-term protection against failure of the picture tube in your new television. Our Picture Tube Protection Plan enables you to avoid any unexpected picture tube repair expenses and keep your television in top condition. It guarantees you a genuine Zenith replacement picture tube and service from a Zenith authorized service center.



Be sure to send in the Product Registration Card. We will send you an application for the Protection Plan near the expiration of the two-year manufacturer's warranty on the picture tube. For additional information call (256) 774-4088.

Free Manuals Download Website

<http://myh66.com>

<http://usermanuals.us>

<http://www.somanuals.com>

<http://www.4manuals.cc>

<http://www.manual-lib.com>

<http://www.404manual.com>

<http://www.luxmanual.com>

<http://aubethermostatmanual.com>

Golf course search by state

<http://golfingnear.com>

Email search by domain

<http://emailbydomain.com>

Auto manuals search

<http://auto.somanuals.com>

TV manuals search

<http://tv.somanuals.com>