

Installation and Operating Guide | Warranty

Model Number | XBS344 | DVD/VCR Receiver Home Theater System with Speakers
(Speakers : DTE-5105WE/DTE-550TE)



© Copyright 2003, Zenith Electronics Corporation



Safety Precautions



CAUTION
RISK OF ELECTRIC SHOCK
DO NOT OPEN



CAUTION: TO REDUCE THE RISK OF ELECTRIC SHOCK DO NOT REMOVE COVER (OR BACK) NO USER-SERVICEABLE PARTS INSIDE REFER SERVICING TO QUALIFIED SERVICE PERSONNEL.



The lightning flash with arrowhead symbol within an equilateral triangle is intended to alert the user to the presence of uninsulated dangerous voltage within the product's enclosure that may be of sufficient magnitude to constitute a risk of electric shock to persons.



The exclamation point within an equilateral triangle is intended to alert the user to the presence of important operating and maintenance (servicing) instructions in the literature accompanying the product.

WARNING: TO REDUCE THE RISK OF FIRE OR ELECTRIC SHOCK, DO NOT EXPOSE THIS APPARATUS TO RAIN OR MOISTURE.

CAUTION: TO PREVENT ELECTRIC SHOCK, MATCH WIDE BLADE OF PLUG TO WIDE SLOT, FULLY INSERT.

ATTENTION: POUR ÉVITER LES CHOC ÉLECTRIQUES, INTRODUIRE LA LAME LA PLUS LARGE DE LA FICHE DANS LA BORNE CORRESPONDANTE DE LA PRISE ET POUSSER JUSQU'AU FOND.

WARNING: Do not install this equipment in a confined space such as a bookcase or similar unit.

NOTE TO CABLE/TV INSTALLER: This reminder is provided to call the cable TV system installer's attention to Article 820-40 of the National Electric Code (U.S.A.). The code provides guidelines for proper grounding and, in particular, specifies that the cable ground shall be connected to the grounding system of the building, as close to the point of the cable entry as practical.

CAUTION:

This DVD/VCR Receiver employs a Laser System.

To ensure proper use of this product, please read this owner's manual carefully and retain for future reference. Should the unit require maintenance, contact an authorized service center.

Use of controls, adjustments, or the performance of procedures other than those specified herein may result in exposure to hazardous radiation.

To prevent direct exposure to laser beam, do not try to open the enclosure. Visible laser radiation when open. DO NOT STARE INTO BEAM.

CAUTION: The apparatus should not be exposed to water (dripping or splashing) and no objects filled with liquids, such as vases, should be placed on the apparatus.

FCC WARNING: This equipment may generate or use radio frequency energy. Changes or modifications to this equipment may cause harmful interference unless the modifications are expressly approved in the instruction manual. The user could lose the authority to operate this equipment if an unauthorized change or modification is made.

REGULATORY INFORMATION: FCC Part 15

This product has been tested and found to comply with the limits for a Class B digital device, pursuant to Part 15 of the FCC Rules. These limits are designed to provide reasonable protection against harmful interference when the product is operated in a residential installation. This product generates, uses, and can radiate radio frequency energy and, if not installed and used in accordance with the instruction manual, may cause harmful interference to radio communications. However, there is no guarantee that interference will not occur in a particular installation. If this product does cause harmful interference to radio or television reception, which can be determined by turning the product off and on, the user is encouraged to try to correct the interference by one or more of the following measures:

- Reorient or relocate the receiving antenna.
- Increase the separation between the product and receiver.
- Connect the product into an outlet on a circuit different from that to which the receiver is connected.
- Consult the dealer or an experienced radio/TV technician for help.

FCC COMPLIANCE: The responsible party for this product's compliance is:

Zenith Electronics Corporation, 2000 Millbrook Drive, Lincolnshire, IL 60069, USA
Phone: 1-847-941-8000.



NOTES ON COPYRIGHTS:

It is forbidden by law to copy, broadcast, show, broadcast via cable, play in public, or rent copyrighted material without permission.

This product features the copy protection function developed by Macrovision. Copy protection signals are recorded on some discs. When recording and playing the pictures of these discs on a VCR, picture noise will appear.

This product incorporates copyright protection technology that is protected by method claims of certain U.S. patents and other intellectual property rights owned by Macrovision Corporation and other rights owners. Use of this copyright protection technology must be authorized by Macrovision Corporation, and is intended for home and other limited viewing uses only unless otherwise authorized by Macrovision Corporation. Reverse engineering or disassembly is prohibited.

SERIAL NUMBER: The serial number is found on the back of this unit. This number is unique to this unit and not available to others. You should record requested information here and retain this guide as a permanent record of your purchase.

Model No. XBS344

Serial No. _____

IMPORTANT SAFETY INSTRUCTIONS

CAUTION: PLEASE READ AND OBSERVE ALL WARNINGS AND INSTRUCTIONS IN THIS OWNER'S MANUAL. AND THOSE MARKED ON THE PRODUCT. RETAIN THIS MANUAL FOR FUTURE REFERENCE.

This product has been designed and manufactured to assure personal safety. Improper use can result in electric shock or fire hazard. The safeguards incorporated in this product will protect you if you observe the following procedures for installation, use, and servicing.

This product does not contain any parts that can be repaired by the user.

DO NOT REMOVE THE CABINET COVER, OR YOU MAY BE EXPOSED TO DANGEROUS VOLTAGE. REFER SERVICING TO QUALIFIED SERVICE PERSONNEL ONLY.

- 1. Read these instructions.** - All safety and operating instructions should be read before the product is operated.
- 2. Keep these instructions.** - The safety, operating and use instructions should be retained for future reference.
- 3. Heed all warnings.** - All warnings on the product and in the operating instructions should be adhered to.
- 4. Follow all instructions.** - All operating and use instructions should be followed.
- 5. Do not use this product near water.** - For example: near a bath tub, wash bowl, kitchen sink, laundry tub, in a wet basement; or near a swimming pool; and other areas located near water.
- 6. Clean only with dry cloth.** - Unplug this product from the wall outlet before cleaning. Do not use liquid cleaners.
- 7. Do not block any ventilation openings. Install in accordance with the manufacturer's instructions.** - Slots and openings in the cabinet are provided for ventilation and to ensure reliable operation of the product and to protect it from over-heating. The openings should never be blocked by placing the product on a bed, sofa, rug or other similar surface. This product should not be placed in a built-in installation such as a bookcase or rack unless proper ventilation is provided or the manufacturer's instructions have been adhered to.
- 8. Do not install near any heat sources such as radiators, heat registers, stoves, or other apparatus (including amplifiers) that produce heat.**
- 9. Do not defeat the safety purpose of the polarized or grounding-type plug.** A polarized plug has two blades with one wider than the other. A grounding type plug has two blades and a third grounding prong. The wide blade or the third prong are provided for your safety. If the provided plug does not fit into your outlet, consult an electrician for replacement of the obsolete outlet.
- 10. Protect the power cord from being walked on or pinched particularly at plugs, convenience receptacles, and the point where they exit from the product.**
- 11. Only use attachments/accessories specified by the manufacturer.**
- 12. Use only with the cart, stand, tripod, bracket, or table specified by the manufacturer, or sold with apparatus. When a cart is used, use caution when moving the cart/product combination to avoid injury from tip-over.**
- 13. Unplug this product during lightning storms or when unused for long periods of time.**
- 14. Refer all servicing to qualified service personnel. Servicing is required when the product has been damaged in any way, such as power-supply cord or plug is damaged, liquid has been spilled or objects have fallen into the product, the product has been exposed to rain or moisture, does not operate normally, or has been dropped.**



Table of Contents

Introduction

Safety Precautions	2
IMPORTANT SAFETY INSTRUCTIONS	3
Table of Contents	4
Before Use	5-6
Playable Discs	5
Precautions	6
Notes on Discs	6
About Symbols	6
Front Panel	7
Display Window Overview	8
Remote Control Overview	9
Rear Panel Connections Overview	10

Preparation

Connections	11-14
Connecting Antenna/Cable TV to a DVD/VCR Receiver	11
Basic TV Connections	12
Optional TV Connections	12
Speaker System Connections	13
Speaker Positioning	13
Radio Antenna Connections	14
Accessory Audio/Video (A/V) Connections to DVD/VCR Receiver	14
Digital Device Connections	14
Selecting the Input/Output Source	15
Sound Mode Setup and Descriptions	16
Mini Glossary for Audio Stream & Surround Mode	16
Sound Mode	16
VCR Operation Setup	17-19
On-Screen Display(OSD)	17
On-Screen Menus Setup	17
VCR Setup Menu Options	18
Channel Selection	18
Setting the Clock	19
DVD Operation Setup	20-23
DVD Operational Overview	20
On-Screen Display	20
Initial Settings	21-23
• <i>Basic Menu Operation</i>	21
• <i>Language</i>	21
• <i>Picture</i>	21
• <i>Progressive Scan</i>	21
• <i>Speaker Setup</i>	22
• <i>Others(DRC/Vocal/AutoPlay)</i>	22
• <i>Parental Control</i>	23

Operation

VCR Operation	24-29
Normal Playback	24
Special Effect Playbacks	24
• <i>Search</i>	24
• <i>Still Picture and Frame-by-Frame Playback</i>	24
• <i>Slow Motion</i>	24
• <i>CM SKIP (Commercial Skip)</i>	24
• <i>EZ(EASY) Review</i>	24
Normal Recording	25
Timer Recording	25-26
Instant Timer Recording	27
Dubbing and Editing	27
Copying from DVD to VCR	27
VHS Hi-Fi Stereo System/MTS Broadcast	28
Tape Counter Memory Feature	29
Additional Information	29
DVD Operation	30-32
Playing DVDs	30
General Features	30-32
• <i>Selecting TITLES</i>	30
• <i>Selecting CHAPTERs</i>	30
• <i>Slow Motion</i>	30

• <i>Still Picture and Frame-by-Frame Playback</i>	30
• <i>Search</i>	31
• <i>Random</i>	31
• <i>Repeat</i>	31
• <i>Repeat A-B</i>	31
• <i>Time Search</i>	31
• <i>3D Surround</i>	31
• <i>Zoom</i>	31
• <i>Marker Search</i>	32
• <i>Changing Video Mode</i>	32
Special DVD Features	32

• <i>Checking the contents of DVD Video discs: Menus</i>	32
• <i>Title Menu</i>	32
• <i>Disc Menu</i>	32
• <i>Camera Angle</i>	32
• <i>Changing the Audio Language</i>	32
• <i>Subtitle</i>	32
• <i>Screen Saver</i>	32

Audio CD and MP3 Disc Operation

Playing Audio CDs and MP3 Discs	33
MP3 Recording Notes	33
• <i>Pause</i>	34
• <i>Selecting Tracks</i>	34
• <i>Repeat Track/ All/ Off</i>	34
• <i>Search</i>	34
• <i>Random</i>	34
• <i>Repeat A-B</i>	34
• <i>3D Surround</i>	34
• <i>Changing the Audio Channel</i>	34

JPEG File Operation

Viewing JPEG Files on a Disc	35
• <i>Selecting other Files</i>	35
• <i>Still Picture</i>	35
• <i>To flip the picture</i>	35
• <i>To rotate picture</i>	35
Notes on JPEG Files	35

Programmed Playback

Programmed Playback with Audio CDs or MP3 Discs	36
• <i>Repeat Programmed Tracks</i>	36
• <i>Erasing a Track from the Program List</i>	36
• <i>Erasing the Program List</i>	36

Speaker Setup

Radio Operation

Presetting available Radio Stations	38
Listening to the Radio	38
For your Reference	39
Tuning in a Station Automatically	39
Labeling Stations	39

Reference

Troubleshooting	40-42
Language Code List	43
Country Code List	44
Specifications	45-46
Notes	47
Warranty	Rear Cover

About the symbols for instructions



 Indicates hazards likely to cause harm to the unit itself or other material damage.

 Indicates special operating features of this unit.

 Indicates tips and hints for making the task easier.

Before Use

Playable Discs

	DVD (8 cm / 12 cm disc)
	Audio CD (8 cm / 12 cm disc)

In addition, this unit can play a DVD-R/±RW, Kodak PICTURE CD, CD-R or CD-RWs that contain audio titles, MP3, or JPEG files.

Notes

- Depending on the condition of the recording equipment or the CD-R/RW (or DVD-R/±RW) disc itself, some CD-R/RW (or DVD-R/±RW) discs cannot be played on the unit.
- Do not attach any seal or label to either side (the labeled side or the recorded side) of a disc.
- Do not use irregularly shaped CDs (e.g., heart-shaped or octagonal). Doing so may result in malfunctions.

Notes on DVDs

Some playback operations of DVDs may be intentionally fixed by software manufacturers. As this unit plays DVDs according to disc content designed by the software manufacturer, some playback features of the unit may not be available or other functions may be added. Make sure to also refer to the instructions supplied with the DVDs. Some DVDs made for business purposes may not be playable on this unit.

Regional code of the DVD/VCR Receiver and DVDs

This DVD/VCR Receiver is designed and manufactured for playback of region "1" encoded DVD software. The region code on the labels of some DVDs indicates which type of player can play those discs. This unit can only play DVDs labelled "1" or "ALL". If you try to play any other discs, the message "Check Regional Code" will appear on the TV screen. Some DVDs that have no region code label may still be subject to area restrictions and therefore not playable.



IMPORTANT NOTE:

SPENT OR DISCHARGED BATTERIES MUST BE RECYCLED OR DISPOSED OF IN A SAFE MANNER IN COMPLIANCE WITH ALL APPLICABLE LAWS. FOR DETAILED INFORMATION, CONTACT YOUR LOCAL COUNTY SOLID WASTE AUTHORITY.

Disc-related terms

Title (DVD only)

The main film content or accompanying feature content or additional feature content, or music album. Each title is assigned a title reference number enabling you to locate it easily.

Chapter (DVD only)

Sections of a picture or a musical piece that are smaller than titles. A title is composed of one or several chapters. Each chapter is assigned a chapter number, enabling you to locate the chapter you want. Depending on the disc, chapters may not be recorded.

Track (audio CD only)

Sections of a picture or a musical piece on an audio CD. Each track is assigned a track number, enabling you to locate the track you want.

Remote Control Operating Range

Point the remote control at the remote sensor and press the buttons.

- **Distance:** About 6m (20ft) from the front of the remote sensor
- **Angle:** About 30° in each direction of the front of the remote sensor

Remote Control Battery Installation

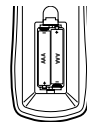

Detach the battery cover on the rear of the remote control, and insert two R03 (size AAA) batteries with + and - aligned correctly.

Caution

Do not mix old and new batteries. Never mix different types of batteries (standard, alkaline, etc.).

Before Use (Continued)

Precautions

Handling the unit

When shipping the unit

For maximum protection, use the original carton and packing materials when shipping or transporting the unit. Re-pack the unit as it was originally packaged at the factory.

When setting up the unit

The picture and sound of a nearby TV, VCR, or radio may be distorted during playback. In this case, position the unit away from the TV, VCR, or radio, or turn off the unit after removing the disc.

To keep the surface clean

Do not use volatile liquids, such as insecticide spray, near the unit. Do not leave rubber or plastic products in contact with the unit for a long period of time. They will leave marks on the surface.

Cleaning the unit

To clean the cabinet

Use a soft, dry cloth. If the surfaces are extremely dirty, use a soft cloth lightly moistened with a mild detergent solution. Do not use strong solvents such as alcohol, benzene, or thinner, as these might damage the surface of the unit.

To obtain a clear picture

The DVD/VCR Receiver is a high-tech, precision device. If the optical pick-up lens and disc drive parts are dirty or worn, the picture quality will be poor. Regular inspection and maintenance are recommended after every 1,000 hours of use. (This depends on the operating environment.)
For details, please contact your nearest dealer.

Notes on Discs

Handling discs

Do not touch the playback side of the disc.
Hold the disc by the edges so that fingerprints will not get on the surface.
Do not stick paper or tape on the disc.

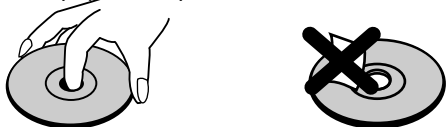

Storing discs

After playing, store the disc in its case.
Do not expose the disc to direct sunlight or sources of heat, or leave it in a parked car exposed to direct sunlight, as there may be a considerable temperature increase inside the car.

Cleaning discs

Fingerprints and dust on the disc can cause poor picture quality and sound distortion. Before playing, clean the disc with a clean cloth. Wipe the disc from the center out.

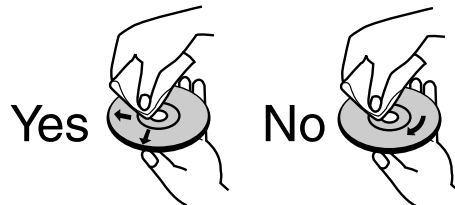

Do not use strong solvents such as alcohol, benzene, thinner, commercially available cleaners, or anti-static spray intended for older vinyl records.



About Symbols

About the symbol display

“” may appear on the TV screen during operation. This icon means the function explained in this owner's manual is not available at that moment or with that specific DVD.

About the disc symbols for instructions

A section whose title has one of the following symbols are applicable only to those discs represented by the symbol.

-  DVDs.
-  Audio CDs.
-  MP3 Discs.
-  JPEG Files.

Selecting the Viewing Source

To view the DVD's output:

Press DVD on the remote or DVD/VCR on the front panel until the DVD indicator in the display window lights. Video from the DVD should now be viewed on the TV screen.

To view the VCR's output:

Press VCR on the remote or DVD/VCR on the front panel until the VCR indicator in the display window lights. Video from the VCR should now be viewed on the TV screen.

Notes

- If you insert a disc while the DVD/VCR Receiver is in the VCR mode, the DVD/VCR Receiver will switch to DVD mode automatically.
- If you insert a cassette tape without an erasure prevention tab intact while the DVD/VCR Receiver is in the DVD mode, the DVD/VCR Receiver will switch to VCR mode automatically.

Front Panel

POWER

Switches the DVD/VCR Receiver ON and OFF.

EJECT

Ejects the tape in the VCR deck.

LINE2 (VIDEO IN/AUDIO IN (Left/Right))

Connect the audio/video output of an external source (Audio system, TV/ Monitor, another VCR).

VOLUME

Adjusts sound level of speakers.

Disc Tray (DVD deck)

Insert a disc here.

PLAY (▶)

To play back a recorded tape.

CH/PRESET (▲/▼)

Scans up or down through memorized channels or radio frequencies (stations).

PAUSE/STEP (||/▶)

Pause playback or recording temporarily/press repeatedly for frame-by-frame playback.

TUNING (▲/▼)

Scans available radio frequencies in the area.

STOP (■)

Stops playback or recording.

REC/ITR (●)

To record normally or to activate Instant Timer Recording.

Video Cassette Compartment (VCR deck)

Insert a video cassette here.

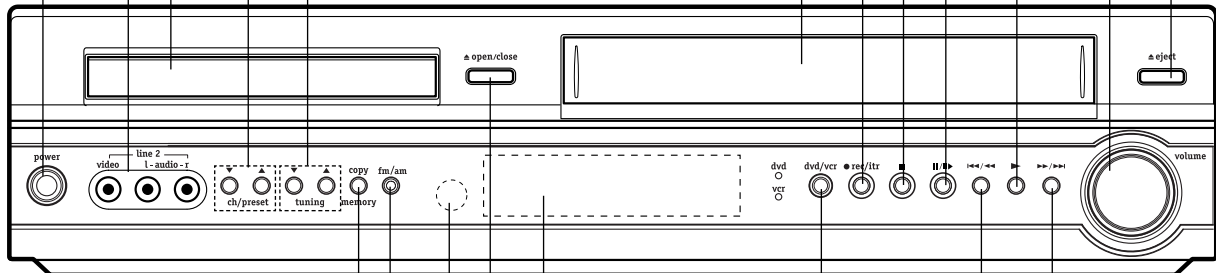

COPY/MEMORY

Press to copy a DVD in the DVD deck to a VCR tape in the VCR deck. Memorizes currently tuned Radio frequency (station).

Display window

Shows the current status of the DVD/VCR Receiver.

FM/AM

Selects Radio operation mode.

OPEN/CLOSE

Opens or closes the disc tray.

DVD/VCR

Toggles control between the DVD deck and the VCR deck.

Remote Sensor

Point the DVD/VCR Receiver remote control here.

BACKWARD (◀◀/▶▶)

DVD: Goes to beginning of current chapter/track or to previous chapter/track. Press and hold for a fast reverse search.

VCR: Rewinds the tape from STOP mode or for fast reverse picture search.

FORWARD (▶▶/▶▶▶)

DVD: Goes to NEXT chapter/track. Press and hold for two seconds for a fast forward search.

VCR: Advances the tape from STOP mode or for fast forward picture search.

Display Window Overview

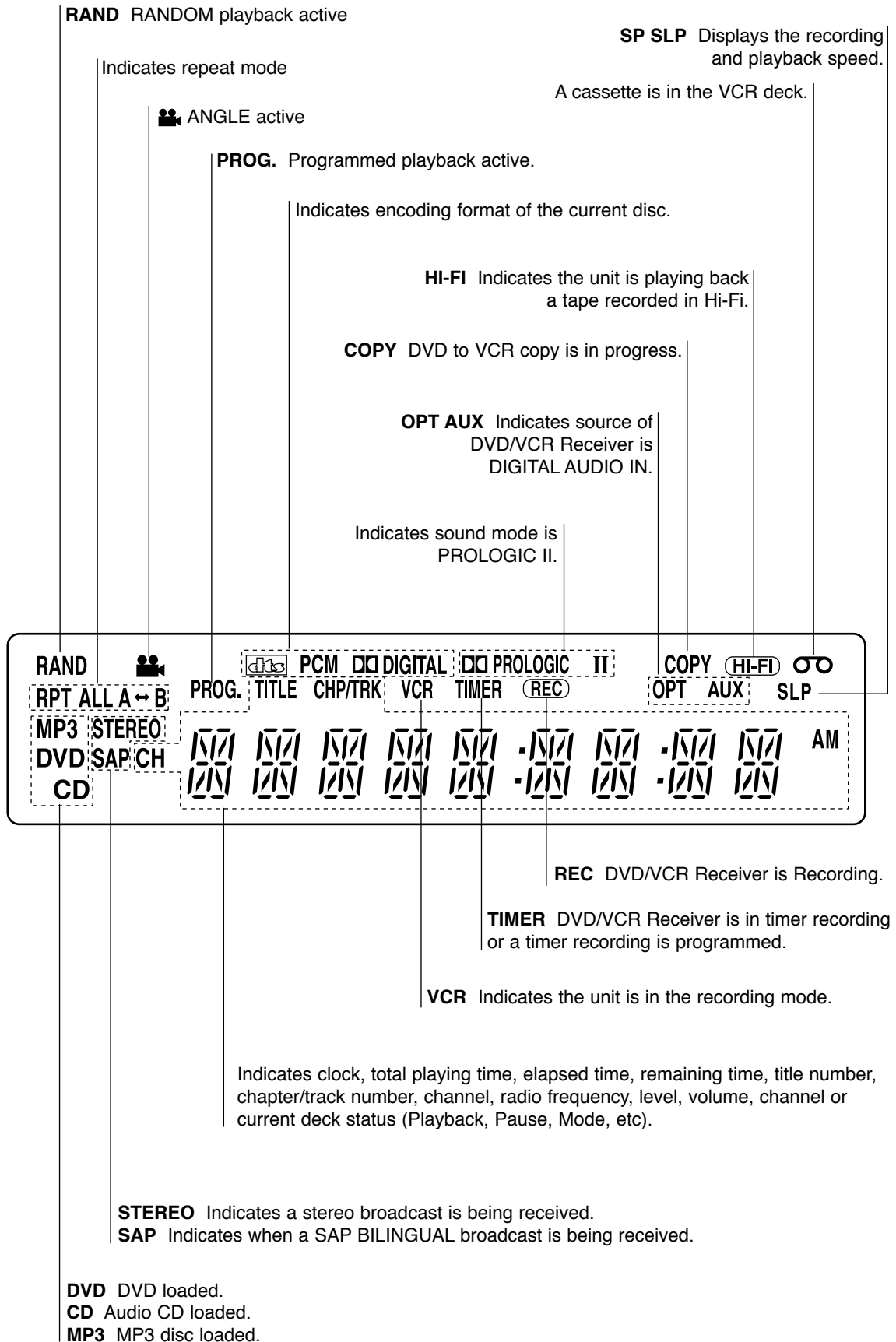

Remote Control Overview

- OPEN/CLOSE, EJECT (▲)**
 - Opens and closes the disc tray.
 - Ejects the tape in the VCR deck.
- INPUT**
 - Selects the VCR deck's source (Tuner, LINE 1, or LINE 2).
- SOUND MODE**
 - Selects sound mode : BYPASS, PRO LOGIC, PRO LOGICII (MOVIE, MUSIC, MATRIX) or 3D SURROUND.
- 0-9 numerical buttons**
 - Selects numbered menu options.
- ZOOM**
 - Enlarges DVD video image.
- ANGLE**
 - Selects a DVD camera angle if available.
- SUBTITLE**
 - Selects a subtitle language.
- TITLE ●**
 - Displays the disc's Title menu, if available.
- DISPLAY, CLK/CNT**
 - Accesses On-Screen display.
 - Switches between clock, tape counter, and tape remaining modes on the display.
- ◀/▶/▲/▼ (left/right/up/down)**
 - Selects an option in the menu.
- CH/TRK (▲/▼)**
 - Selects VCR channels.
 - Manually adjusts the tape's picture onscreen.
- RETURN**
 - Removes the Setup menu.
- TV/VCR ●**
 - To view channels selected by the VCR tuner or by the TV tuner.
- STOP ●**
 - Stops playback.
- PAUSE/STEP ●**
 - Pause playback or recording temporarily/press repeatedly for frame-by-frame playback.
- PLAY ●**
 - Starts playback.
- REC/ITR (●) ●**
 - Records normally or activates Instant Timer Recording.
- A-B, SP/SLP ●**
 - Repeats sequence.
 - Selects recording speed.
- REPEAT, EZ review ●**
 - Repeat chapter, track, title, all.
 - Replays the specified segment twice.
- RANDOM, CM Skip ●**
 - Plays tracks in random order.
 - Fast forwards picture search through 30 seconds of recording.

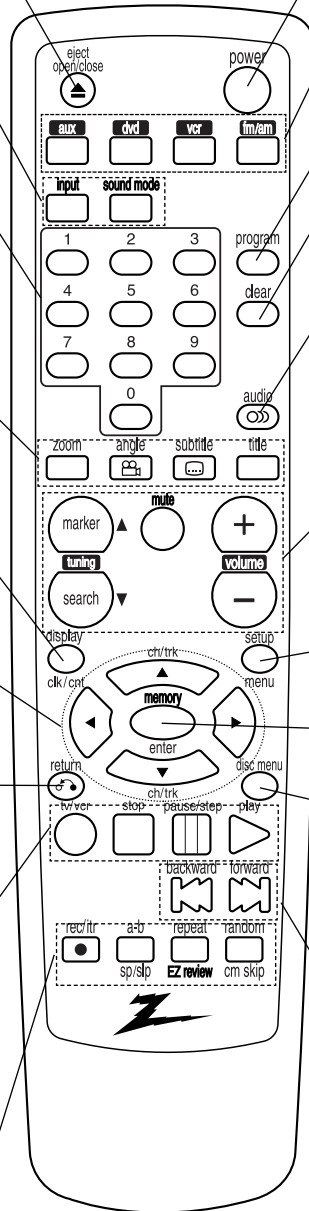

- POWER**
 - Switches DVD/VCR Receiver ON and OFF.
- AUX/DVD/VCR/FM/AM select buttons**
 - Select the output source (DVD, VCR, AUX or FM/AM) to view on the TV screen.
- PROGRAM**
 - Accesses or removes Program menu.
- CLEAR**
 - Removes a track number on the program menu or a mark on the MARKER SEARCH menu.
- AUDIO**
 - Selects an audio language (DVD) or an audio channel (CD).
- MARKER**
 - Marks any point during playback.
- SEARCH**
 - Displays MARKER SEARCH menu.
- TUNING ▲/▼**
 - To tune in the desired station.
- MUTE**
 - Turns off sound from speaker connectors, AUDIO OUT and RF OUT jacks.
- VOLUME (+/-)**
 - Adjusts volume of speaker.
- SETUP, MENU**
 - Accesses or removes DVD Setup menu and VCR menu.
- MEMORY/ENTER**
 - Acknowledges menu selection.
 - Displays functions on the TV screen.
- DISC MENU**
 - Accesses menu on a DVD disc.
- BACKWARD**
 - DVD: Search backward*/go to beginning of current chapter or track or go to previous chapter or track.
 - VCR: Rewinds the tape in STOP mode or for fast reverse picture search.
 - * Press and hold button for about two seconds.
- FORWARD**
 - DVD: Search forward*/go to next chapter or track.
 - VCR: Advances the tape in STOP mode or for fast forward picture search.
 - * Press and hold button for about two seconds.

Note

This remote control uses the same buttons for VCR and DVD functions (ex. PLAY). To use the VCR, first press the VCR button. To use the DVD, first press the DVD button.

Rear Panel Connections Overview

VCR IN LINE 1 (VIDEO IN/AUDIO IN (Left/Right))

Connect the audio/video output of an external source (Audio system, TV/Monitor, another VCR).

DVD/VCR OUT (VIDEO/AUDIO (Left/Right))

Connect to a TV with video and audio inputs.

COMPONENT/PROGRESSIVE SCAN VIDEO OUT (Y Pb Pr) (DVD OUT)

Connect to a TV with Y Pb Pr inputs. FOR DVD VIEWING ONLY.

RF.OUT (DVD/VCR OUT)

Connect to a TV with RF coaxial inputs.

ANT.IN

Connect the VHF/UHF/CATV antenna to this terminal.

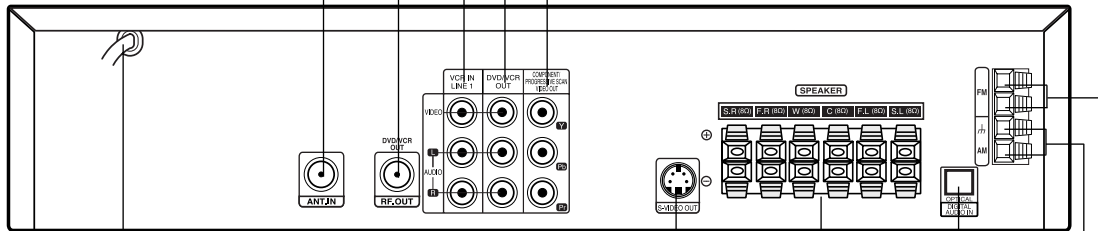

AC Power Cord

Plug into the power source.

S-VIDEO OUT (DVD OUT)

Connect to a S-Video Input on TV. FOR DVD VIEWING ONLY.

SPEAKER Connectors

Connect the six supplied speakers to these terminals.

DIGITAL AUDIO IN (OPTICAL)

Connect to a digital audio output on a digital device.

AM Antenna Connectors

Connect the AM antenna to these terminals.

FM Antenna Connectors

Connect the FM antenna to these terminals.

Dust Protection Cap

Remove the dust protection cap from the OPTICAL DIGITAL IN jack and connect the optical digital cable (not supplied) securely so that the configurations of both the cable and the connector match. Keep the dust protection cap and always reattach the cap when not using the connector to protect against dust intrusion.

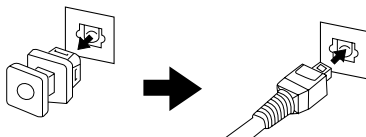

Do not touch the inner pins of the jacks on the rear panel. Electrostatic discharge may cause permanent damage to the unit.

Connections

Tips

- Depending on your TV and other equipment you wish to connect, there are various ways you could connect the DVD/VCR Receiver. Use connections described on pages 11-14.
- Please refer to the manuals of your TV, VCR, Stereo System or other devices as necessary to make the best connections.

Caution

- Make sure the DVD/VCR Receiver is connected directly to the TV. Tune the TV to the correct video input channel.
- Do not connect the DVD/VCR Receiver's DVD/VCR AUDIO OUT jack to the phono in jack (record deck) of your audio system.
- Do not connect your DVD/VCR Receiver via your VCR. The DVD image could be distorted by the copy protection system.

Connecting Antenna/Cable TV to DVD/VCR Receiver

1 Disconnect the antenna leads from the rear of the TV.

2 Identify the type of cable from your antenna. If it is a round cable as illustrated, it is a 75 ohm coaxial antenna cable. This cable will connect directly to the jack marked ANT.IN on your DVD/VCR Receiver.

Tip

If your antenna lead wire is a flat type antenna cable, connect it to an Antenna Adapter (300-ohm to 75-ohm) (not supplied) and slip the adapter onto the ANT.IN jack. The adapter does not screw on to the DVD/VCR Receiver, it just slips over the jack.

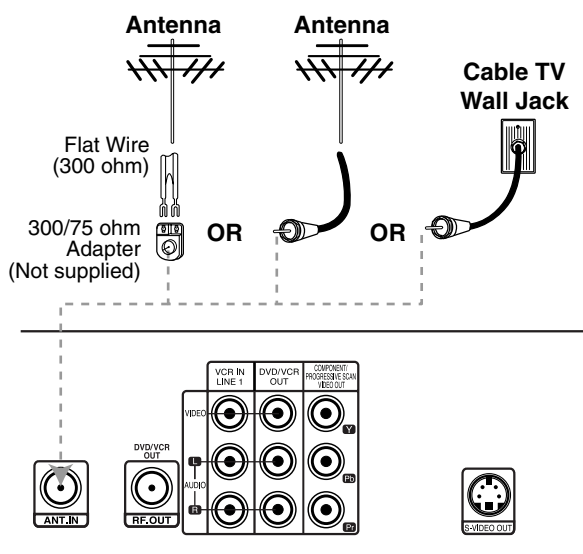

DVD+VCR Connections Panel

Without Cable Box

If your cable wire is connected to your TV without a converter or descrambler box, unscrew the wire from your TV and attach it to the ANT.IN jack on the DVD/VCR Receiver. Use the supplied round coaxial cable to connect between the DVD/VCR Receiver's RF.OUT jack and the 75 ohm antenna input jack on the TV. With this connection, you can receive all midband, super band, and hyperband channels (all cable channels).

With Cable Box

If a converter is required in your cable system, follow the instruction below:

The cable hookup permits both TV and DVD/VCR Receiver operation.

To view or record a CATV channel

- 1 Tune the TV to the DVD/VCR Receiver output channel (CH 3 or 4).
- 2 Set the DVD/VCR Receiver channel selector to the output channel of the Cable Converter box using CH/TRK (▲/▼) or number (0-9) of your DVD/VCR Receiver. (Example: CH3)
- 3 Select the channel to view at the Cable Converter Box.

Notes

- With this connection, you CANNOT record one program while viewing another.
- If you are using a cable box to tune channels, it is not necessary to do Auto Channel Programming, (Auto Channel Search) as indicated on page 18.

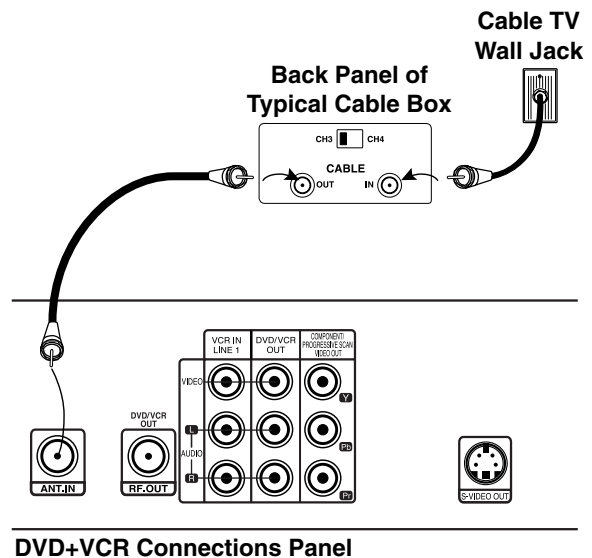

DVD+VCR Connections Panel

Connections (Continued)

Basic TV Connections

Make one of the following connections, depending on the capabilities of your TV.

RF coaxial connection

Connect the RF.OUT jack on the DVD/VCR Receiver to the antenna in jack on the TV using the 75-ohm Coaxial Cable supplied (R).

Note

If you use this connection, tune the TV to the DVD/VCR Receiver's RF output channel (CH 3 or 4).

How to set the DVD/VCR Receiver's RF output channel

While the DVD/VCR Receiver is turned off, press and hold CH/PRESET (▲▼) on the front panel for about five seconds to change the RF output channel (CH 03 or CH 04). "RF 03" or "RF 04" appears in the display window.

Audio/Video connection

- 1 Connect the DVD/VCR VIDEO OUT jack on the DVD/VCR Receiver to the video in jack on the TV using the supplied video cable (V).
- 2 Connect the Left and Right DVD/VCR AUDIO OUT jacks on the DVD/VCR Receiver to the audio left/right in jacks on the TV (A) using the supplied audio cables.

Note

If you use this connection, set the TV's source selector to VIDEO.

Typical TV Connections Panel

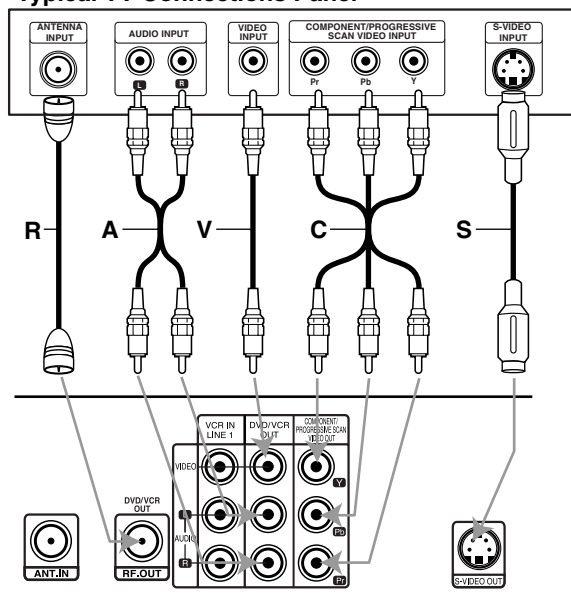

DVD+VCR Connections Panel

Optional TV Connections

Note

The S-VIDEO OUT and COMPONENT/PROGRESSIVE SCAN VIDEO OUT connection options below only work with DVD playback. The tuner and VCR will still output through the RF.OUT (R) or DVD/VCR OUT (A, V) jack. (See left)

S-Video Connection

- 1 Connect the S-VIDEO OUT jack on the DVD/VCR Receiver to the S-Video in jack on the TV using the supplied S-Video cable (S).
- 2 Connect the Left and Right AUDIO OUT jacks on the DVD/VCR Receiver to the audio left/right in jacks on the TV using the supplied audio cables (A).

Component Video (Color Stream®) connection

- 1 Connect the COMPONENT/PROGRESSIVE SCAN VIDEO OUT jacks on the DVD/VCR Receiver to the corresponding in jacks on the TV using user-supplied Y Pb Pr cables (C).
- 2 Connect the Left and Right AUDIO OUT jacks of the DVD/VCR Receiver to the audio left/right in jacks on the TV (A) using the supplied audio cables.

Progressive Scan (ColorStream® pro) connection

- If your television is a high-definition or "digital ready" television, you may take advantage of the DVD/VCR Receiver's progressive scan output for the highest video resolution possible.
- If your TV does not accept the Progressive Scan format, the picture will appear scrambled if you try Progressive Scan on the DVD/VCR Receiver.

- 1 Connect the COMPONENT/PROGRESSIVE SCAN VIDEO OUT jacks on the DVD/VCR Receiver to the corresponding in jacks on the TV using an optional Y Pb Pr cable (C).
- 2 Connect the Left and Right AUDIO OUT jacks of the DVD/VCR Receiver to the audio left/right in jacks on the TV (A) using the supplied audio cables.

Notes

- Set Progressive Scan to "On" on the DVD setup menu for progressive signal, see page 21.
- Progressive scan does not work with the analog video connections (yellow VIDEO OUT jack).

Connections (Continued)

Speaker System Connections

Connect the speakers using the supplied speaker wire by matching the colors of the terminals and those of the wires. To obtain the best possible surround sound, adjust the speaker parameters (distance, level, etc.).

Notes

- Be sure to match the speaker wire to the appropriate terminal on the components: ⊕ to ⊕ and ⊖ to ⊖. If the wires are reversed, the sound will be distorted and lack bass.
- The front speakers have a low maximum input rating, adjust the volume carefully to avoid excessive volume output to the speakers.
- Do not disassemble the front covers of supplied speakers.

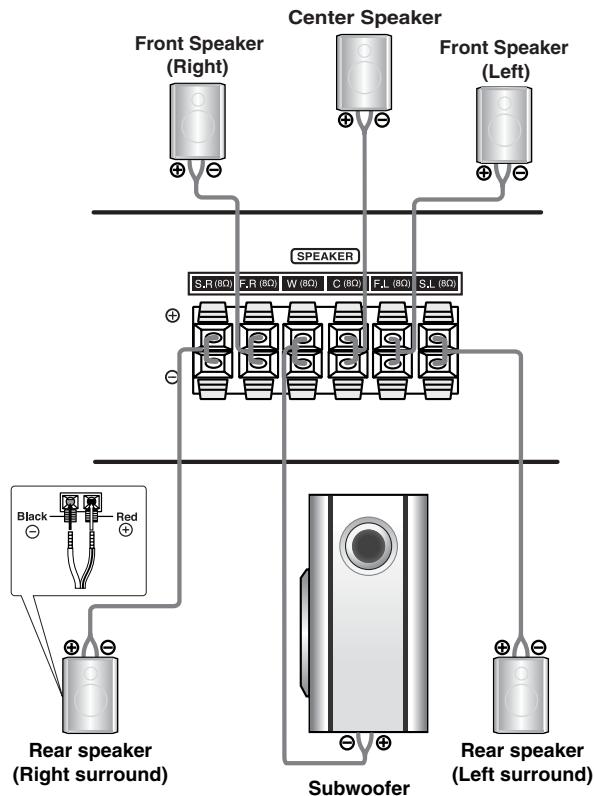

About Ferrite Core

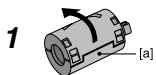

Be sure to attach the ferrite core to the speaker cables (for connecting to this unit). This ferrite core can reduce noises.

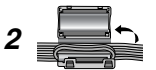

How to attach the ferrite core.

1 Push the stopper [a] of the ferrite core to open.

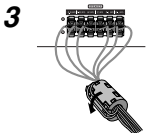

2 Wind the Center and Subwoofer Speaker cables once on the ferrite core. Pass the others straight on the ferrite core.

3 Close the ferrite core until it clicks.

Speaker Positioning

For a normal setup use 6 speakers (2 front speakers, center speaker, 2 rear speakers and subwoofer).

• Front Speakers

Based on your listening position, set up the speakers at equal distance. And by hearing position, set up an interval between speakers of 45 degree.

• Center Speaker

It is ideal if the center speaker and front speakers are at the same height. But normally place the center speaker above or below the television as shown below.

• Rear Speakers

Place the rear surround speakers to the left and right behind the primary listening area. These speakers recreate sound motion and atmosphere required for surround playback. For best results, do not install the rear speakers too far behind the listening position, install them at or above the level of the listener's ears. It is also effective to direct the rear speakers towards a wall or ceiling to further disperse the sound. For smaller room sizes, if the audience is near the rear wall, set the rear speakers opposite each other 60 - 90 cm (23.6 - 35.4 inch) above the listener's ears.

• Subwoofer

This can be placed in any front position.

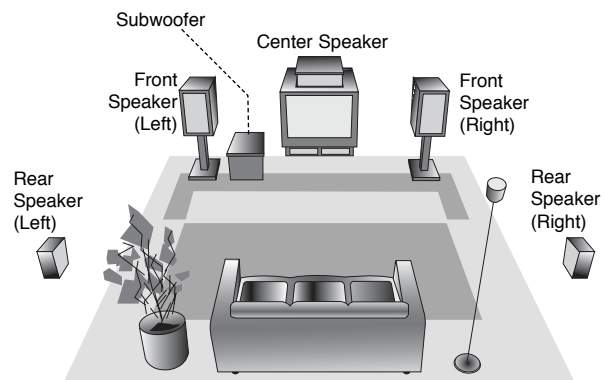

Speaker Positioning Example

Connections (Continued)

Radio Antenna Connections

Connect the supplied FM/AM antennas for radio listening.

- 1** Connect the AM loop antenna to the AM antenna connectors.
- 2** Connect the FM wire antenna to the FM antenna connectors.

Notes

- To prevent noise pickup, keep the AM loop antenna away from the DVD/VCR Receiver and other components.
- Be sure to fully extend the FM wire antenna.
- After connecting the FM wire antenna, keep it as horizontal as possible.

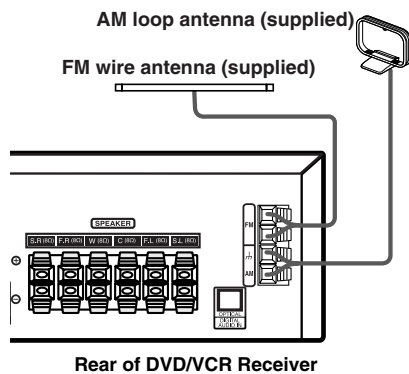

Rear of DVD/VCR Receiver

Accessory Audio/Video (A/V) Connections to DVD/VCR Receiver

Connect the VCR IN LINE1 or LINE2 jacks on the DVD/VCR Receiver to the audio/video out jacks on your accessory component, using optional audio/video cables.

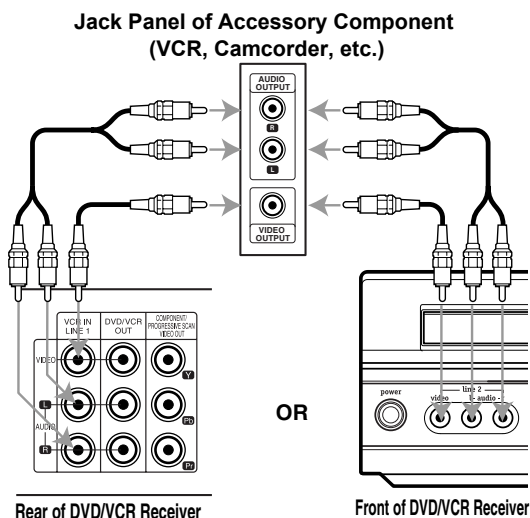

Rear of DVD/VCR Receiver

Front of DVD/VCR Receiver

Digital Device Connections

Connect the DIGITAL AUDIO IN (OPTICAL) jack on the DVD/VCR Receiver to the digital audio out (optical) jack on your digital device (Game device, Digital Set Top Box, etc.), using optional optical audio cable. To set DVD+VCR source to OPTICAL IN, press AUX on the remote control.

Notes

- If the audio format of the digital output does not match the capabilities of your DVD/VCR Receiver, the DVD/VCR Receiver will produce a strong, distorted sound or no sound at all.
- The Optical input function is available only when the other unit's Sampling Frequency is 32 - 48kHz.

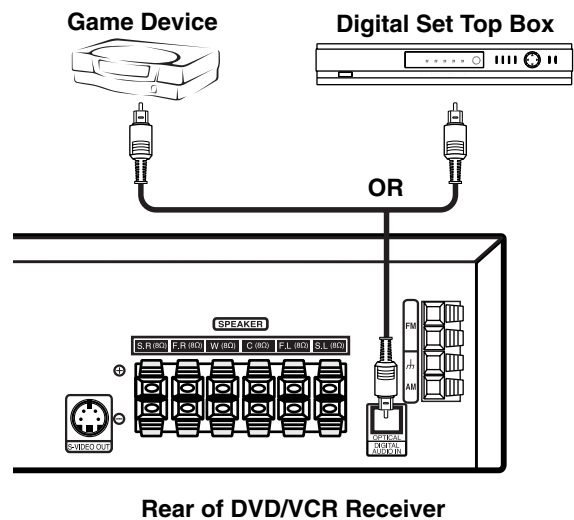

Rear of DVD/VCR Receiver

Selecting Input/Output Sources

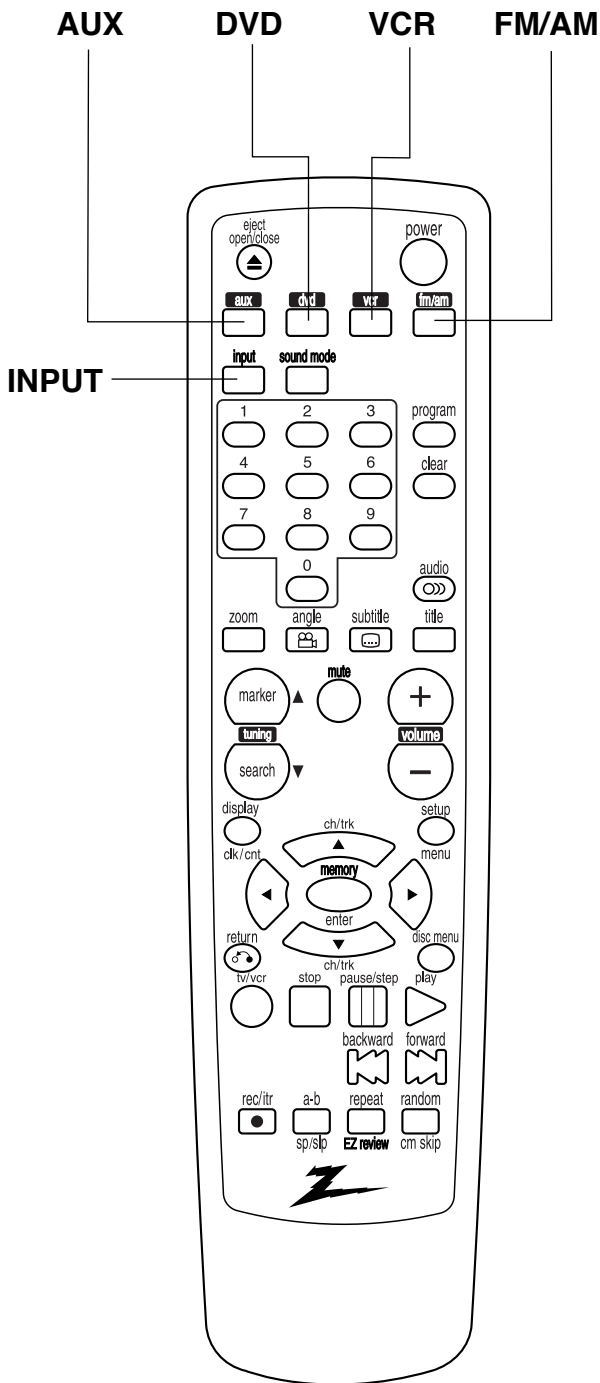

Follow these guidelines to select and switch between the various DVD/VCR Receiver input and output sources:

- **DVD**

- To view output from the DVD deck:**

- Press DVD on the remote or DVD/VCR on the front panel until the DVD indicator on the front panel lights and output from the DVD deck is viewed on the TV screen.

- **VCR**

- To view output from the VCR deck:**

- Press VCR on the remote or DVD/VCR on the front panel until the VCR indicator on the front panel lights and output from the VCR deck is viewed on the TV screen.

- **FM/AM**

- To listen to AM/FM radio broadcasts:**

- Press fm/am on the remote to toggle between AM and FM radio. The selected frequency appears on the front panel display.

- **AUX**

- To listen to an audio source connected to the DIGITAL AUDIO IN (OPTICAL) jack with video from LINE 1:**

- Press AUX on the remote control once. DIGITAL AUDIO IN will appear and the OPT/AUX indicator will light on the front panel display. Audio will come from an external source connected to the DIGITAL AUDIO IN (OPTICAL) jack and video will come from an external source connected to the VIDEO IN jack of LINE 1 (for rear panel).

- To listen to an audio source connected to the AUDIO IN jack of LINE1 with video from LINE 1:**

- Press AUX on the remote control a second time. ANALOG AUDIO IN will appear and the OPT/AUX indicator will turn off on the front panel display. Audio will come from an external source connected to the AUDIO IN jacks of LINE1 (for rear panel) and video will come from an external source connected to the VIDEO IN jack of LINE 1 (for rear panel).

- **INPUT**

- To view a source connected to the front or rear LINE inputs:**

- First, press VCR to select the VCR deck, and then use INPUT to select LINE1 (for rear panel) or LINE2 (for front panel).

Sound Mode Setup and Descriptions

Mini Glossary for Audio Stream & Surround mode

(DTS)

Allows you to enjoy 5.1 (or 6) discrete channels of high quality digital audio from DTS program sources such as discs, DVD and compact discs, etc. bearing the trademark. DTS Digital Surround delivers up to 6 channels of transparent audio (which means identical to the original masters) and results in exceptional clarity throughout a true 360 degree sound field. The term DTS is a trademark of DTS Technology, LLC. Manufactured under license from DTS Technology, LLC.

DIGITAL (Dolby Digital)

The Dolby Digital surround format lets you enjoy up to 5.1 channels of digital surround sound from a Dolby Digital program source. If you play DVDs with "" mark, you can enjoy even better sound quality, greater spatial accuracy, and improved dynamic range.

PRO LOGIC (Dolby Pro Logic)

Use this mode when playing movie or Dolby Digital 2 channel which carries the "" mark. This mode provides the effect of being in a movie theater or live concert house—an effect with an intensity which can only be obtained through DOLBY PRO LOGIC SURROUND. The effect of the front/back/left/right movement of the sound image, as well as the sense of fixed position in the sound image, is much clearer and more dynamic than before.

PRO LOGIC II (Dolby Pro Logic II)

Dolby Pro Logic II creates five full-bandwidth output channels from two-channel sources. This is done using an advanced, high-purity matrix surround decoder that extracts the spatial properties of the original recording without adding any new sounds or tonal colorations.

MOVIE mode:

The Movie mode is for use with stereo television shows and all programs encoded in Dolby Surround. The result is enhanced soundfield directionality that approaches the quality of discrete 5.1-channel sound.

MUSIC mode:

The Music mode is for use with any stereo music recordings, and provides a wide and deep sound space. Music mode includes controls that allow the sound to be tailored to individual listening tastes.

MATRIX mode:

The Matrix mode is the same as the Music mode except that the directional enhancement logic is turned off. It may be used to enhance mono signals by making them seem "larger." Matrix mode may also find use in auto systems, where the fluctuations from poor FM stereo reception can otherwise cause disturbing surround signals from a logic decoder. The ultimate "cure" for poor FM stereo reception may be simply to force the audio to mono.

3D SURROUND

This unit can produce a 3D Surround effect, using 3D Surround Sound technology, which simulates multi-channel audio playback from two conventional stereo speakers instead of the five or more speakers normally required to listen to multi-channel audio from a home theater. This feature works with DVD discs encoded with Dolby Pro Logic and Dolby Digital audio tracks.

BYPASS

Software with multichannel surround audio signals is played according to the way it was recorded.

Sound Mode

You can enjoy surround sound simply by selecting one of the pre-programmed sound fields according to the program you want to listen to.

Press **SOUND MODE** repeatedly until the sound mode you want appears in the display window, see below.

Each time you press **SOUND MODE**, the sound mode is changed in the following order;



BYPASS → PRO LOGIC → MOVIE → MUSIC → MATRIX → 3D SURR

While DVD is inserted



You can change the sound mode of DVD (Dolby Digital, DTS, PCM, etc) by pressing the **AUDIO** button on the remote during playback.

Although the DVD contents differ from disc to disc, the following explains the basic operation when this feature is used.

Each time you press the **AUDIO** button, the DVD's sound mode is changed in the following order;

 →  → PCM → 

For your reference

- The DVD/VCR Receiver memorizes the last mode settings for each source individually.
- You can identify the encoding format of program software by looking at its packaging.
 - Dolby Digital discs are labeled with the  logo.
 - Dolby Surround encoded programs are labeled with the  logo.
 - DTS Digital Surround discs are marked with DTS.

Note

When you play sound tracks with 96kHz sampling frequency, the output signals will be converted to 48kHz (sampling frequency).

Volume Control

You can adjust the sound by rotating VOLUME on the front panel or by pressing VOLUME (+/-) on the remote control repeatedly.

Muting

Press **MUTING** to turn off the sound.

You can mute your unit in order, for example, to answer the telephone, "MUTING" indicator appears in the display window. To exit mute mode, press **MUTING** again.

VCR Operation Setup

On-Screen Display (OSD)

VCR functions are displayed during VCR operation.

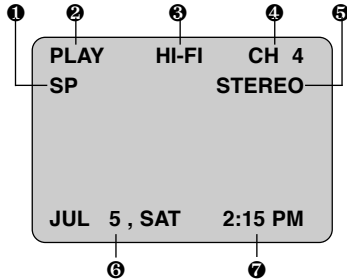

- 1 TAPE SPEED DISPLAY**
Shows the current tape speed.
- 2 FUNCTION DISPLAY**
Indicates the function in progress.
- 3 HI-FI DISPLAY**
Indicates the unit is playing back tape recorded in Hi-Fi.
- 4 CHANNEL DISPLAY**
Indicates the selected channel (or LINE1(L1), LINE2(L2)).
- 5 STEREO/SAP DISPLAY (MONO is not displayed)**
Shows the type of audio signal received by the VCR tuner.
- 6 DATE DISPLAY**
Shows the current date. (Month/Date/Day of the week format)
- 7 CLOCK/COUNT/REMAIN DISPLAY**
Shows the current time, the tape counter and remaining time on the tape.

Each press of the **MEMORY/ENTER** changes the TV on-screen displays in the following sequence.

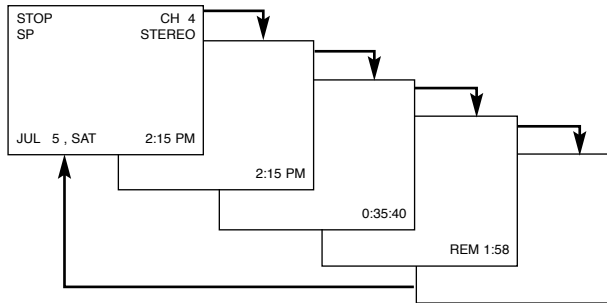

Notes

- The function displays remain on the TV screen for 5 seconds.
- The clock (or tape counter, tape remaining) mode will remain on the screen until you press **MEMORY/ENTER**.
- The tape counter and the remaining tape length indicator appear only when a cassette is inserted. Also, the remaining tape length indicator appears after any tape operation.

EASY INFORMATION

If the Extended Data Service (XDS) signals are provided along with normal TV signal in your area or during playback of a tape recorded with Extended Data Service (XDS) signals, the station ID, program title, and program details are shown on the TV screen.

If viewing a channel with Extended Data Service (XDS) signals, press **MEMORY/ENTER** and the station ID will appear on the TV screen. Press **MEMORY/ENTER** again and the program details will appear on the TV screen.

If viewing a tape recorded with Extended Data Service (XDS) signals, press **MEMORY/ENTER** twice and the program title and program details will appear on the TV screen.

PROGRAM DETAILS

LENGTH: Indicates the run length of a program.

TIME REMAINING: Indicates the remaining time of a program.

RATING: Indicates the rating of the current program (N/A, G, PG, PG-13, R, NC-17, X and Not Rated). The rating N/A means that the motion picture ratings are not applicable to this program.

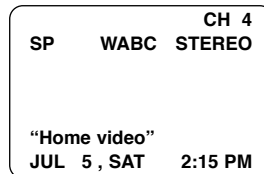

Easy Information Screen (Station ID)

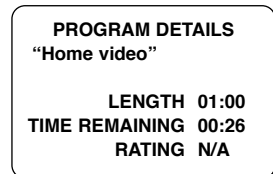

Easy Information Screen (Program details)

On-Screen Menu Setup

The **SETUP**, clock setting (**CLOCK**), and timer recordings (**PROGRAM**) features are accessed conveniently with the on-screen menus, that lead you through each step. The following pages describe the on-screen menu selections available.

Menu Selection

Your VCR allows remote control adjustment of several features.

- 1** Press **MENU** and the **MAIN** menu will appear.
- 2** Select the desired menu with **▲/▼** button and then press **MEMORY/ENTER**.

Note

Menus remain on-screen for 3 minutes.

MAIN MENU

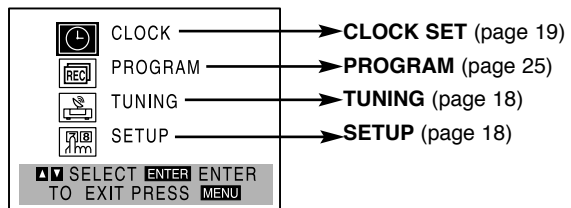

- 3** Press **MENU** when finished.

VCR Operation Setup (Continued)

VCR Setup Menu Options

- 1 Press **MENU** and the **MAIN** menu will appear.
- 2 Use **▲/▼** to select the **SETUP** menu, then press **MEMORY/ENTER**.
The **SETUP** menu will appear.

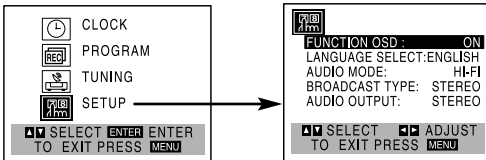

- 3 Use **▲/▼** to choose a desired option on the **SETUP** menu. Then use **◀/▶** to choose a desired setting.

FUNCTION OSD

The on-screen display of this DVD/VCR Receiver can be turned on or off.

- **FUNCTION OSD** can be switched between **ON** and **OFF** using **◀/▶**.

LANGUAGE SELECT

The on-screen programming of this DVD/VCR Receiver can be displayed in either English, Spanish, or French.

- **LANGUAGE SELECT** can be switched between **ENGLISH**, **SPANISH** and **FRENCH** using **◀/▶**.

AUDIO MODE

The DVD/VCR Receiver has two separate audio playback systems, the high quality VHS Hi-Fi system and standard NORMAL mono system. The same audio is generally recorded on both systems. The VHS Hi-Fi system plays on separate (left and right) channels, and the NORMAL system plays monaural sound. The normal track is always played so the cassette can be played on a DVD/VCR Receiver that does not have VHS Hi-Fi.

- **AUDIO MODE** can be switched between **HI-FI** and **NORMAL** using **◀/▶**.

BROADCAST TYPE (STEREO/SAP/MONO)

Multichannel Television Sound (MTS) carries stereo and/or Second Audio Program (SAP) bilingual signals. Set this display to the desired position when both MTS stereo and SAP signals are received. When only one of the MTS signal is received, the DVD/VCR Receiver automatically selects the corresponding receiving mode (Stereo or SAP) regardless of the selected position. For normal operation, the display should be in the **STEREO** position. The DVD/VCR Receiver will then record a **STEREO** program when available, and record a mono program IF the program is **NOT IN STEREO**.

For weak **STEREO** and/or **SAP** broadcasts, changing the display to mono may give clearer sound.

- **BROADCAST TYPE** can be switched between **STEREO**, **SAP**, and **MONO** using **◀/▶**.

AUDIO OUTPUT (STEREO/LEFT/RIGHT)

Used during playback [when **AUDIO MODE** (**HI-FI**/**NORMAL**) is in **HI-FI** position] for selecting the audio output signals from the **AUDIO OUT** terminals (L ch and R ch), and **RF. OUT**.

This display setting should normally be left in the **stereo** position, so that when a stereo tape is played, the stereo sound will be heard through the left and right channels. If a mono tape is played and the audio output is set to **stereo**, the same mono sound will be heard from both left and right channels.

- **AUDIO OUTPUT** can be switched between **STEREO**, **LEFT**, and **RIGHT** using **◀/▶**.

- 4 Press **MENU** when finished.

Channel Selection

This DVD/VCR Receiver is equipped with a frequency synthesized tuner capable of receiving up to 181 channels. These include VHF channels 2-13, UHF channels 14-69 and CATV channels 1-125.

Preparation:

- Connect the DVD/VCR Receiver to the desired type of antenna or cable TV system, as shown in "Connecting Antenna/Cable TV to DVD/VCR Receiver" on page 11.

AUTO CHANNEL PROGRAMMING

- 1 Press **MENU** and the **MAIN** menu will appear.
- 2 Use **▲/▼** to select the **TUNING** menu, then press **MEMORY/ENTER**.
The **TUNING** menu will appear.

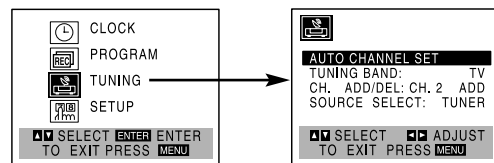

- 3 Use **▼** to choose the **SOURCE SELECT** option, then use **◀/▶** to select **TUNER**.
Press **◀/▶** repeatedly to switch between **TUNER**, **LINE1(L1)** and **LINE2(L2)**.
- 4 Use **▲/▼** to choose the **AUTO CHANNEL SET** option, then use **◀/▶** to search for channels.
The tuner will automatically cycle through all available channels in the area and place them in the tuner's memory.
- 5 After the **AUTO CHANNEL SET** **PROCEEDING** is complete, make sure the **TUNING BAND** is set appropriately (**TV** or **CATV**) using **▲/▼** and choosing the correct **TUNING BAND** (**TV** or **CATV**) by using **◀/▶** while in the **TUNING** menu. Remember, **TV** is for the air antenna reception, **CATV** is for cable or wireless cable connection.
- 6 Press **MENU** to return to the **TV** screen.
- 7 Use **CH/TRK** (**▲/▼**) or **CH** (**▲/▼**) on the front panel to cycle the DVD/VCR Receiver through the channels in memory.

TO ADD OR ERASE CHANNELS FROM MEMORY

This feature allows you to add or erase channels in memory manually.

- 1 Use **▼** to choose the **CH. ADD/DEL** option on the **TUNING** menu. Use **◀/▶** to select a channel to add or erase.
- 2 Use **MEMORY/ENTER** to add or erase the channel. Repeat steps 1 and 2 to add or erase channels.
- 3 Press **MENU** to return to the **TV** screen.

VCR Operation Setup (Continued)

Setting the Clock

The DVD/VCR Receiver gives you two ways to set the time and date: the Auto Clock Feature or manually. The Auto Clock feature enables the DVD/VCR Receiver to set up the clock while the DVD/VCR Receiver is turned off.

Things to know before starting

- The clock uses the 12-hour system. (Be sure to set AM and PM correctly.)
- The initial Clock Setting is **JANUARY 1, 2003, 12:00 AM**.

Auto Clock Set

The Auto Clock Set feature is set to ON at the factory. In the ON setting, the DVD/VCR Receiver looks for a channel carrying XDS (Extended Data Services) information. XDS updates the clock using the Coordinated Universal Time.

The Auto Clock feature enables the DVD/VCR Receiver to set up the clock while the DVD/VCR Receiver is turned off.

- 1 Press **MENU** and the MAIN menu will appear.
- 2 Use **▲/▼** to choose the **CLOCK** menu. Press **MEMORY/ENTER** and the **CLOCK** menu will appear.

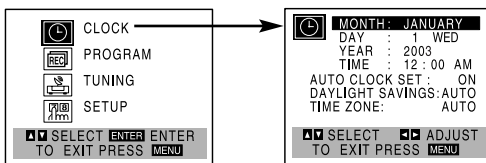

- 3 Use **▼** to choose the **AUTO CLOCK SET** option. Use **◀/▶** to choose **ON**.

The Auto Clock Set feature is set to ON at the factory. In the ON setting, the DVD/VCR Receiver looks for a channel carrying XDS (Extended Data Services) information. XDS updates the clock using the Coordinated Universal Time.

- 4 Use **▼** to choose the **DAYLIGHT SAVINGS** option.

Use **◀** or **▶** to choose **AUTO, ON, or OFF**.

If you choose **AUTO**, the VCR sets the clock using the DST information broadcast in the signal (channel). If you choose **ON**, the VCR adjusts the clock for Daylight Saving Time automatically.

- 5 Use **▼** to choose the **TIME ZONE** option. Use **◀** or **▶** to choose the correct time zone (**AUTO, EASTERN, CENTRAL, MOUNTAIN, PACIFIC, ALASKA** or **HAWAII**).

If "AUTO" is selected as the time zone, the VCR sets the clock using the first Coordinated Universal Time information it finds in a broadcast signal.

- 6 Press **MENU** when finished.

- 7 Turn off the DVD/VCR Receiver and the auto clock set feature sets the time.

Note

There are cases where the TV station does not send or sends the wrong time. Therefore, the incorrect time will be set. If this happens we recommend that you set the clock manually.

Manual Clock Set

- 1 Press **MENU** and the MAIN menu will appear.
- 2 Use **▲/▼** to choose the **CLOCK** menu. Press **MEMORY/ENTER** and the **CLOCK** menu will appear.

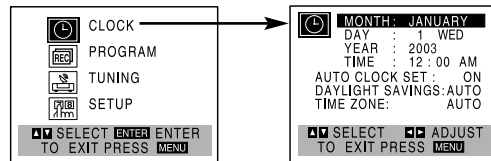

- 3 Use **◀/▶** to choose the month.
- 4 Use **▼** to choose the **DAY** option. Use **◀/▶** to choose the date. The day of the week will display automatically.
- 5 Use **▼** to choose the **YEAR** option. Use **◀/▶** to choose the year.
- 6 Use **▼** to choose the **TIME** option. Use **◀/▶** to choose the time. Press and hold **◀/▶** to advance clock continuously.
- 7 Use **▼** to choose the **DAYLIGHT SAVINGS** option. Use **◀** or **▶** to choose **AUTO, ON, or OFF**. If you choose **AUTO**, the VCR sets the clock using the DST information broadcast in the signal (channel). If you choose **ON**, the VCR adjusts the clock for Daylight Saving Time automatically.

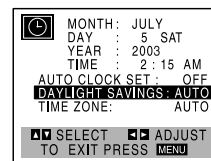

- 8 Press **MENU** when finished.

Note

If setting the clock manually, "AUTO CLOCK SET" must be set to "OFF".

If set to "ON", an incorrect date and/or time will be entered again when the DVD/VCR Receiver is turned off.

DVD Operation Setup

DVD Operational Overview



This manual gives basic instructions for operating the DVD/VCR Receiver. Some DVDs require specific operation or allow only limited operation during playback. When this occurs, the symbol  appears on the TV screen, indicating that the operation is not permitted by the DVD/VCR Receiver or is not available on the disc.



On-Screen Display

General playback status can be displayed on the TV screen. Some options can be changed on the menu.

On-screen display operation







1 Press DISPLAY during playback.

2 Use  /  to select a menu option. The selected option will be highlighted.

3 Use  /  to change the setting of the menu option.

The number buttons can be also be used for setting numbers (e.g., title number). For some functions, press MEMORY/ENTER to execute the setting.





















Playback Status Indicator Icons

	Repeat Title
	Repeat Chapter
	Repeat A-B
	Repeat Off
	Resume play from this point
	Action prohibited or not available

Notes

- Some discs may not provide all of the on-screen display features shown below.
- If no button is pressed for 10 seconds, the on-screen display disappears.

DVD

Menu Options	Description (Use  /  to select option)	Selection Method
Title Number  1 / 3	Shows the current title number and total number of titles, and skips to the desired title number.	 /  , or Numbers, MEMORY/ENTER
Chapter Number  1 / 12	Shows the current chapter number and total number of chapters, and skips to the desired chapter number.	 /  , or Numbers, MEMORY/ENTER
Time search  0:20:09	Shows the elapsed playing time, and searches the point directly from the elapsed time.	Numbers, MEMORY/ENTER
Audio language and Digital Audio Output mode  1 ENG D D D 5.1 CH	Shows the current audio soundtrack language, encoding method, and channel number, and changes the setting.	 /  , or AUDIO
Subtitle language  OFF	Shows the current subtitles language, and changes the setting.	 /  , or SUBTITLE
Angle  1 / 1	Shows the current angle number and total number of angles, and changes the angle number.	 /  , or ANGLE
Sound  BYPASS	Shows the current sound mode, and changes the setting.	 /  , or SOUND MODE

DVD Operation Setup (Continued)

Initial Settings

You can set your personal preferences on the DVD+VCR.

Basic Menu Operation

- 1 Press **SETUP**.
The Setup menu appears.



- 2 Use **▲/▼** to select the desired option.
The screen will show the current setting for the selected option, as well as alternate setting(s).
- 3 While the desired option is selected, press **▶**, then **▲/▼** to select the desired setting.
- 4 Press **MEMORY/ENTER** to confirm your selection.
Some options require additional steps.
- 5 Press **SETUP**, **RETURN**, or **PLAY** to exit the setup menu.

Language

Disc Language **(DVD)**

Select a language for the disc's Menu, Audio, and Subtitle features.

Original : The original language set for the disc is selected.

Other : To select another language, use number buttons to enter the corresponding 4-digit number according to the language code list on page 43. If you enter the wrong language code, press **CLEAR**.

Note

Disc Language selection may not work for some DVDs.



Menu Language

Select a language for the Setup menu. This is the menu you see when you press **SETUP**.



Picture

TV Aspect **(DVD)**

4:3 Letterbox: Select when a standard 4:3 TV is connected. Displays pictures with masking bars above and below the picture.

4:3 Panscan: Select when a standard 4:3 TV is connected. Displays pictures cropped to fill your TV screen. Both sides of the picture are cut off.

16:9 Wide: Select when a 16:9 wide TV is connected.

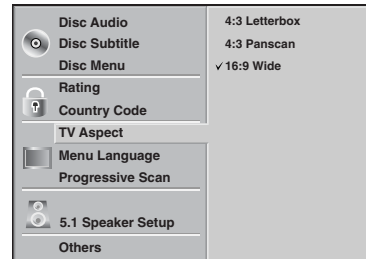

Progressive Scan **(DVD)**

Progressive Scan Video provides the highest resolution pictures with less flicker and line structure.

If you are using the **COMPONENT/PROGRESSIVE SCAN VIDEO OUT** jacks, but are connecting the DVD+VCR to a standard (analog) television, set Progressive Scan to **Off**.

If you are using the Component Video jacks for connection to a TV or monitor that is compatible with a progressive scan signal, set Progressive Scan to **On**.

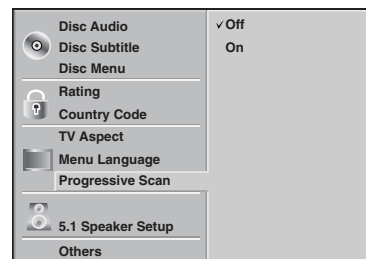

Caution

Once the setting for progressive scan output is entered, an image will only be visible on a progressive scan compatible TV or monitor. If you set Progressive Scan to **On** in error, you must reset the unit. Pointing the remote at the player, press the **STOP** key to stop any disc that is playing. Next, press the **STOP** key again and hold it for five seconds before releasing it. The video output will be restored to the standard setting, and a picture will once again be visible on a conventional analog TV or monitor.

DVD Operation Setup (Continued)

Speaker setup

5.1 Speaker settings **DVD**

Select speaker settings, including volume, balance and delay time, or test the speaker settings.

Speaker settings are only available in the Analog Multi-Channel Output mode. (See "Speaker Setup", page 37.)

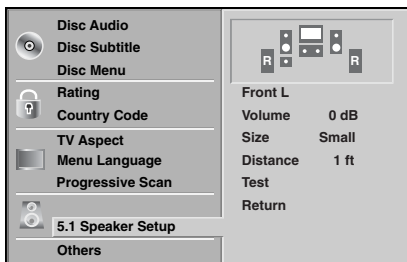

Auto Play **DVD**

You can set up the DVD/VCR Receiver so a DVD disc automatically starts playing whenever the DVD is inserted.

If Auto Play mode is set to On, this DVD/VCR Receiver will search for a title that the playback time of is the longest and then play back the title automatically.

On: Auto Play function is active.

Off: Auto Play function is not active.



The Auto Play function may not work on some DVDs.

Others (DRC/Vocal/AutoPlay)

DRC, Vocal, and Auto Play settings are adjustable.

- Use ▲/▼ to select the desired item and press MEMORY/ENTER. The setting of the selected option is toggled On and Off.

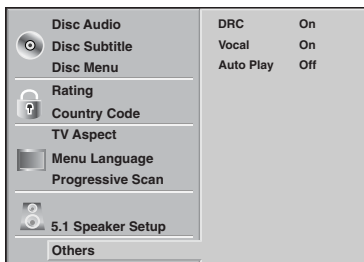

Dynamic Range Control (DRC)

With the DVD format, you can hear a program's soundtrack in the most accurate and realistic presentation possible, thanks to digital audio technology. However, you may wish to compress the dynamic range of the audio output (the difference between the loudest sounds and the quietest ones). Then, you may listen to a movie at a lower volume without losing clarity of sound. Set DRC to On for this effect.

Vocal

Set Vocal to On only when a multi-channel karaoke DVD is playing. The karaoke channels on the disc will mix into normal stereo sound.

DVD Operation Setup (Continued)

Parental Control

Rating **DVD**

Movies on DVDs may contain scenes not suitable for children. Therefore, discs may contain Parental Control information that applies to the complete disc or to certain scenes on the disc. These scenes are rated from 1 to 8, and alternatively, more suitable scenes are available for selection on some discs. Ratings are country dependent. The Parental Control feature allows you to prevent discs from being played by your children or to have certain discs played with alternate scenes.

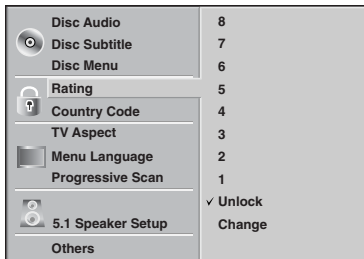

1 Select Rating on the Setup menu using **▲/▼** buttons.

2 While Rating is selected, press **▶**.

3 When you have not entered a password yet. Enter a 4-digit password using the numbered buttons to create a personal 4-digit security password, then press MEMORY/ENTER. Enter the 4-digit password again and press MEMORY/ENTER to verify. **When you have already entered a password;** Enter a 4-digit password using the numbered buttons to confirm the personal 4-digit security password, then press MEMORY/ENTER.

If you make a mistake before pressing MEMORY/ENTER, press CLEAR and enter 4-digit security password again.

4 Select a rating from 1 to 8 using **▲/▼** buttons. **One (1) has the least playback restrictions. Eight (8) has the most playback restrictions.**

Unlock: If you select Unlock, Parental Control is not active. The disc will play in full.

Ratings 1 to 8: Some discs contain scenes not suitable for children. If you set a rating for the DVD+VCR, all disc scenes with the same rating or lower will be played. Higher rated scenes will not be played unless an alternative scene is available on the disc. The alternative must have the same rating or a lower one. If no suitable alternate is found, playback will stop. You must enter the 4-digit password or change the rating level in order to play the disc.

5 Press MEMORY/ENTER to confirm your rating selection, then press SETUP to exit the menu.

Country Code **DVD**

Enter the code of a country whose standards were used to rate the DVD video disc, referring to the list (See "Country Code List", page 44.).

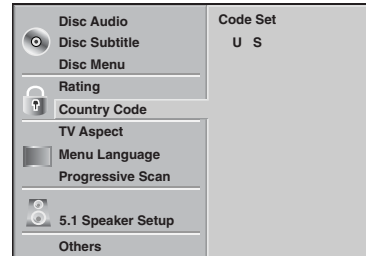

1 Select the Country Code option on the Setup menu using the **▲/▼** buttons.

2 While Country Code is selected, press **▶**.

3 Follow step 3 of "Rating" on left.

4 Select the first character using the **▲/▼** buttons.

5 Press **▶** to shift to second character and select the second character using **▲/▼** buttons.

6 Press MEMORY/ENTER to confirm your Country Code selection, then press SETUP to exit the menu.

Note

Confirmation of the 4-digit password is necessary when the password is changed (see Changing the 4-digit password below).

Changing the 4-digit password

1. Follow Steps 1-2 as shown above to the left (Rating).
2. Enter the old password, then press MEMORY/ENTER.
3. Select Change using **▲/▼** buttons then press MEMORY/ENTER.
4. Enter the new 4-digit password, then press MEMORY/ENTER.
5. Enter exactly the same password a second time and verify by pressing MEMORY/ENTER.
6. Press SETUP to exit the menu.

If you forget your 4-digit password

If you forgot your password, to clear the current password follow the procedure below.

1. Press SETUP to display the Setup menu.
2. Enter the 6-digit number 210499.
The 4-digit password is cleared.
3. Enter a new password as shown above to the left (Rating).

VCR Operation

Normal Playback

Preparation:

- Turn on the TV.
- Tune the TV to the DVD/VCR Receiver output channel (CH 3 or 4) or set the TV's source selector to VIDEO.
- If a direct VIDEO/AUDIO connection is made between the DVD/VCR Receiver and the TV, set the TV's source selector to VIDEO.
- Set the Output Source to VCR as shown in "Selecting Input/Output Sources" on page 15.

1 Insert a prerecorded video cassette.

The  indicator will light and the DVD/VCR Receiver will power-up automatically.

- Make sure that the TIMER indicator in the display window is not lighted. If it is, press **POWER** once.
- If a tape without a safety tab is inserted, the unit will start playback automatically.

2 Press PLAY once.

PLAY appears on the TV screen.

- It is not necessary to select the tape speed for playback. It will be automatically selected by the DVD/VCR Receiver.
- In playback, the **TV/VCR** selector switches to VCR mode automatically.

3 Press STOP to stop playback.

STOP appears on the TV screen.

- If the tape reaches the end before STOP is pressed, the DVD/VCR Receiver will automatically stop, rewind and eject the tape, and it will turn itself off.

Tracking Control

Auto Tracking

The automatic tracking function adjusts the picture to remove snow or streaks.

The AUTO TRACKING function works in the following cases:

- A tape is played back for the first time.
- Tape speed (SP, LP, SLP) changes.
- Streaks or snow appear because of scratches on the tape.

Manual Tracking

If noise appears on the screen during playback, press either **CH/TRK ▲/▼** on the remote control or **CH (▲/▼)** on the front panel until the noise on the screen is reduced.

- If vertical jitter is present, adjust tracking controls very carefully.
- Tracking is automatically reset to normal when the tape is ejected or the power cord is unplugged for more than 3 seconds.

Special Effect Playbacks

Special effects playback notes

- Horizontal lines (noise bars) will appear on the TV screen. This is normal.
- The audio is automatically muted during special effect modes, so there is no sound during search.
- During high-speed picture search mode, a short period is needed to stabilize tape speed when re-entering the PLAY mode. Slight interference may be observed during this period.

Search

This function lets you quickly and visually search for a desired tape section in either direction: forward or reverse.

1. Press BACKWARD or FORWARD during playback.

The DVD/VCR Receiver will be activated in the SEARCH mode.

- If the DVD/VCR Receiver is left in the SEARCH mode for more than 3 minutes, the DVD/VCR Receiver will automatically enter the PLAY mode, to protect the tape and video heads.

2. To return to playback, press PLAY.

Still Picture and Frame-by-Frame Playback

1. Press PAUSE/STEP during playback.

Still picture will appear on the TV screen.

- If a still picture vibrates vertically, stabilize it using **CH/TRK(▲/▼)** on the remote control.
- If the DVD/VCR Receiver is left in the STILL mode for more than 5 minutes, the DVD/VCR Receiver will automatically enter the STOP mode to protect the tape and video heads.

2. Press PAUSE/STEP repeatedly to advance the video picture one frame at a time while viewing a still picture.

3. To return to playback, press PLAY.

Slow Motion

1. While in Still mode, press FORWARD.

The tape will be played back at a speed 1/19 times slower than the normal speed.

- During slow playback, use **CH/TRK(▲/▼)** on the Remote Control to minimize noise bands.
- If slow motion mode continues for more than 3 minutes, the DVD/VCR Receiver will automatically change to playback mode.

2. To return to playback, press PLAY.

CM Skip (Commercial Skip)

This is useful for skipping commercials or short program segments.

1. Press CM Skip during playback.

The tape will fast forward picture search through 30 seconds of recording.

- Skipping time can be extended by pressing CM Skip repeatedly.
- Subsequent presses result in advancing the fast forward picture search time by 30-second increments (maximum 3 minutes).

2. When the search is complete, the DVD/VCR Receiver will go into playback mode automatically.

EZ (EASY) Review

You can replay a specified segment twice.

1 During playback, press and hold ez REVIEW for more than 3 seconds at the end of the segment and your VCR will start reverse search.

2 Release ez REVIEW at the beginning of the segment. The segment is replayed twice automatically.

To return to normal play, press PLAY during easy review playback.

VCR Operation (Continued)

Basic Recording

Preparation:

- Turn on the power of both the DVD/VCR Receiver and TV.
- Tune the TV to the DVD/VCR Receiver output channel (CH 3 or 4) or set the TV's source selector to VIDEO.
- If a direct VIDEO/AUDIO connection is made between the DVD/VCR Receiver and the TV, set the TV's source selector to VIDEO.

1 Insert a video cassette with the safety tab intact.

2 Select the desired channel with CH/TRK ▲▼ or number (0-9) buttons.

- If you are recording from another source via audio/video input jacks (at the Rear or Front panel), select LINE1(L1) or LINE2(L2) with INPUT.

3 Set the desired recording speed (SP or SLP) with the SP/SLP button.

- This DVD/VCR Receiver is not designed to record in LP mode.

4 Set the MTS mode as desired (See page 18, 28).

5 Press REC/ITR (●) once.

Recording will start. (The REC indicator will light in the display window.)

- REC indicator appears only when the Output Source is set to VCR.
- If a cassette with no safety tab is loaded, the cassette will be ejected automatically.

6 Within 5 second, press STOP twice to stop recording.

If the tape reaches the end before STOP is pressed, the DVD/VCR Receiver will automatically stop, rewind, eject the tape and turn itself off.

To pause recording

1. Press PAUSE/STEP to pause the tape during recording.

The REC indicator will flash in the display window.

2. When you want to continue recording, press PAUSE/STEP or REC/ITR (●).

- After 5 minutes in Pause mode, the tape will be stopped automatically to protect the tape and the video heads.

To record one TV program while watching another

- 1 Use TV/VCR to select the TV mode during recording. "TV MODE" appears in the display window.
- 2 Using the TV, select the channel to be viewed.

Tips

Always use PAUSE/STEP for best results when making changes during recording.

For example: To change channels during recording, first press PAUSE/STEP to put the unit into Pause mode. Select the desired channel on the DVD/VCR Receiver, then press PAUSE/STEP again to resume recording.

Timer Recording

This DVD/VCR Receiver can be programmed to record up to 8 programs within a period of 1 year. For unattended recording, the timer needs to know the channels to be recorded and the starting and ending times.

Things to know before starting

- If you try to set the program timer before setting the clock, PLEASE SET THE CLOCK appears for a moment and then CLOCK menu appears on the TV screen. Set the time and date before proceeding.
- Make sure a tape is in the DVD/VCR Receiver and the safety tab is in place or the tape will be automatically ejected.

Preparation:

- Turn on the power of both the DVD/VCR Receiver and the TV.
- Be sure the TV is set to the DVD/VCR Receiver output channel (3 or 4).
- Make sure the TUNING BAND in the TUNING menu is set appropriately (TV or CATV).

1 Press MENU and the MAIN menu will appear.

2 Use ▲▼ to choose the PROGRAM menu.

3 Press MEMORY/ENTER to go to the PROGRAM menu.

The PROGRAM menu will appear.

- If all 8 programs have been entered, FULLY PROGRAMMED message will appear for a moment and then PROGRAM 1 will appear on the TV screen.

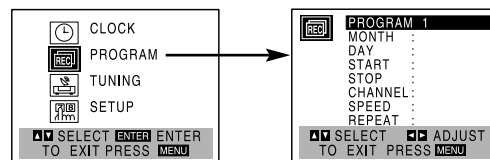

4 Use ◀▶ to choose the PROGRAM No. (1-8).

5 Use ▼ to choose the MONTH option.

Use ◀▶ to choose the desired month.

6 Use ▼ to choose the DAY option.

Use ◀▶ to choose the desired day.

7 Use ▼ to choose the START option.

Use ◀▶ to choose the desired start time.

8 Use ▼ to choose the STOP option.

Use ◀▶ to choose the desired stop time.

9 Use ▼ to choose the CHANNEL option.

Use ◀▶ to choose the desired channel (Channel, LINE1(L1) or LINE2(L2)).

Cable Users: If you have CABLE TV and used Cable Box in Connecting Antenna/Cable TV to DVD/VCR Receiver (page 11), using a cable box converter, you must set the channel in this step to match the cable box output channel (usually CH 3 or 4). Change channels on the cable box instead of with the DVD/VCR Receiver.

VCR Operation (Continued)

10 Use **▼** to choose the **SPEED** option.
Use **◀▶** to choose the desired recording speed (**AUTO, SP or SLP**).

- **AUTO** mode determines how much tape is left and switches speed from **SP** to **SLP**, if necessary, to complete recording the program. There will be some picture and sound distortion at the point of the speed change.

11 Use **▼** to choose the **REPEAT** option.
Use **◀▶** to choose the desired repeat (**ONCE, WEEKLY or DAILY**).

- **ONCE event....**for recording up to 8 programs on a single day or over the days within a period of 1 year.
- **WEEKLY event....**for recording up to 8 programs on a certain day of every week.
- **DAILY event....**for recording up to 8 programs at the same time(s) Monday through Friday.



Tip

If the input data is wrong, use **▲** to select the data and correct it using **◀▶**.

12 Press **MENU**, the program will be memorized by the DVD/VCR Receiver.

- **TIMER** indicator lights in the display window.
- If the program preset time has past, the **PAST TIME PROGRAMMED** message will appear on the TV screen. Return to the incorrect program and program it with the correct time.
- If you had entered a past date, timer recording will be performed on that date of the next year.
- Additional programs may be entered by repeating steps 1-12.

Cable Users: If your cable hookup is via a TV converter box, you can program multiple recordings only on the converter box output channel. This is because the converter determines what channel you view through your DVD/VCR Receiver.

Tip

If you are finished programming and you want to set the DVD/VCR Receiver to record the programs you have entered, **MAKE SURE YOU HAVE INSERTED A TAPE INTO THE DVD/VCR Receiver**. The DVD/VCR Receiver is now set to record the preset programs.

Notes

If the power fails or the DVD/VCR Receiver is unplugged from the AC outlet, the correct clock time and timer settings are kept in memory for approximately 3 seconds. After 3 seconds, the clock and program timer must be reset when power is restored. Reset the clock according to instructions.

After setting up a timer recording, recording will start if no other timer recordings are scheduled to occur at the same time (see "Program Priority" below).

Checking (Erasing) Timer Record Programming

Programming can be checked whenever the DVD/VCR Receiver is turned on.

1. Press **MENU** and the **MAIN** menu will appear.
2. Use **▲▼** to choose the **PROGRAM** menu.
Press **MEMORY/ENTER** and the **PROGRAM** menu will appear.

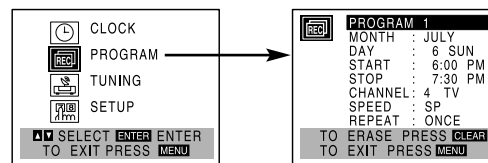

3. Use **◀▶** to select a program you want to check or erase. If you want to erase the program, press **CLEAR**.
4. Press **MENU** to return to the TV screen.

Program Priority

If the starting and ending times of two or more timer recordings overlap on the same day, priority is given to the earliest recording. For example, in the diagram at left Program number 2 will not be recorded until Program number 1 is finished. The first part of Program number 2 will not be recorded. Likewise, Program number 3 will not be recorded until Program number 2 is finished, and so on.

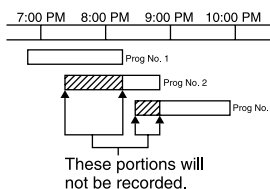

VCR Operation (Continued)

Instant Timer Recording

Instant Timer Recording allows you to make a recording easily of a preset length without using the programmable timer.

Preparation:

- Turn on the power of both the DVD/VCR Receiver and the TV.
- Be sure the TV is tuned to the DVD/VCR Receiver output channel (3 or 4).
- If a direct VIDEO/AUDIO connection is made between the DVD/VCR Receiver and the TV, set the TV's source selector to VIDEO.

- 1 Insert a video cassette with the safety tab intact.**
- 2 Select the desired channel with CH/TRK ▲/▼ or number (0-9) buttons.**

The channel number appears on the TV screen.

 - If you are recording from another source via audio/video input jacks (at the Rear or Front panel), select LINE1(L1) or LINE2(L2).
- 3 Select the desired recording speed (SP or SLP) with the SP/SLP button.**

The tape speed will appear on the TV screen.
- 4 Press REC/ITR (●) twice.**

The menu as illustrated, will appear on the TV screen.

 - Recording will start. (The TIMER indicator will light)
- 5 Press REC/ITR (●) repeatedly to select the recording time length.**

At the end of the recording, the DVD/VCR Receiver will stop recording and shut off.

 - During Instant Timer Recording, changing the channel on the DVD/VCR Receiver will not be possible.
 - You can stop the recording by pressing STOP twice, within 5 seconds.

INSTANT TIMER RECORD MENU

INSTANT TIMER RECORD	
CHANNEL	2
SPEED	SP
START	NOW
LENGTH	0H30M

0H30M 9H00M → 0H00M
↑
Length Display
(each additional press of
REC/ITR (●) increases recording
time 30 minutes)

Checking the Recording Time

Press REC/ITR (●) once to check the recording time. The recalled setting will automatically return to the TV screen after 6 seconds.

To extend the Recording Time

The recording time can be extended anytime by pressing REC/ITR (●).

Subsequent presses result in advancing the recording time by 30-minute increments.

Notes

- If you press PAUSE/STEP during instant timer recording, the DVD/VCR Receiver will enter the recording pause mode. Instant timer recording is cancelled.
- If the DVD/VCR Receiver is set to "0H00M", the DVD/VCR Receiver goes to normal recording mode.

Dubbing and Editing

If you wish to edit or dub your camcorder (or another VCR) recordings to this DVD/VCR Receiver, the rear (or Front) panel mounted Audio and Video (A/V) input jacks make the connections quick and easy. These direct A/V jacks will also provide better picture results than using the ANT.IN jack on the rear panel.

- 1 Connect the camcorder's (or another VCR's) A/V outputs to your DVD/VCR Receiver as illustrated on page 14.**
- 2 Select the input channel "LINE2". (Use INPUT to select LINE2.)**

If you have connected your DVD/VCR Receiver to the A/V input jacks on the rear of DVD/VCR Receiver, you should select the input channel LINE1(L1) by pressing INPUT twice.
- 3 Play the tape in the camcorder (or another VCR). If you have a TV attached to your DVD/VCR Receiver, you can see the video playing.**
- 4 When you desire the recording to begin, press DVD/VCR Receiver's REC/ITR (●) once to start.**

Note

Before recording, please confirm the recording start position.

Copying from DVD to VCR

This unit is capable of copying the contents of a DVD to a VHS tape.

Note

If the DVD you are attempting to copy is copy protected, you will not be able to copy the disc. It is not permitted to copy Macrovision encoded DVDs. "LOCK" is displayed in the display window.

- 1 Insert Disc**

Insert the disc you wish to copy in the DVD deck and close the disc tray.
- 2 Insert VHS Tape**

Insert a blank VHS video tape into the VCR deck.
- 3 Press COPY button on the unit front panel or press REC/ITR (●) button on the remote control.**

The DVD will go into Play mode and the VCR will go into Record mode.

 - If the DVD disc menu appears, you may need to press PLAY manually to begin copying.
 - "COPY" indicator will light.
- 4 Stopping the Copy Process**

When the DVD is finished playing, press the VCR button on the remote control and then press STOP twice to end copying within 5 seconds.

You must stop the Copy process manually when the DVD movie ends, or the unit may replay and record over and over again.

Note

If you stop DVD playback during copying, VCR recording mode also stops automatically. You must set Progressive Scan to Off to use the copy process.

VCR Operation (Continued)

VHS Hi-Fi Stereo System/ MTS Broadcast

This DVD/VCR Receiver is equipped with the VHS Hi-Fi audio sound system for recording and playback. The information below gives a brief description of Hi-Fi audio and how to record and play a tape in the Hi-Fi audio mode.

Playback with Hi-Fi Stereo Audio Sound

A stereo TV with AUDIO/VIDEO input jacks or a stereo audio system is required for true stereo playback. To experience the full and rich stereo sound available with Hi-Fi recorded tapes, we recommend the connection of this unit to a home stereo audio system.

1 Set the AUDIO MODE option to HI-FI on the SETUP menu.

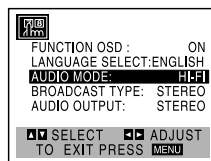

2 Set the AUDIO OUTPUT option to STEREO position.

(STEREO) POSITION: The left channel sound (L) is heard from the left speaker and the right channel sound (R) is heard from the right speaker.

(LEFT) POSITION: The left channel sound (L) is heard from both speakers.

(RIGHT) POSITION: The right channel sound (R) is heard from both speakers.

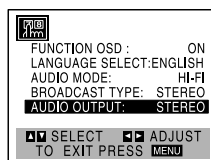

3 Press MENU.

4 Insert a cassette and press PLAY. Adjust sound at your stereo system.

MTS (Multi-Channel TV Sound)

This DVD/VCR Receiver will decode MTS stereo and bilingual (SAP) off-the-air broadcast sound signals. It also decodes stereo TV sound from local cable companies, as long as they operate on assigned cable frequencies and use the EIA-recommended MTS stereo/bilingual TV sound system.

Multichannel TV Sound Indicator (MTS)

Shows onscreen as illustrated below when **MEMORY/ENTER** is pressed.

- One or both of the indicators will light, depending on the MTS broadcast.

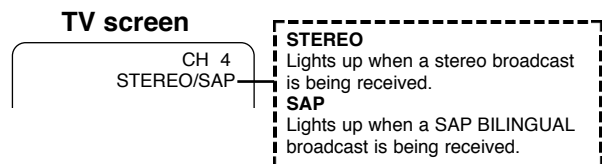

If only STEREO appears on the TV screen.

The DVD/VCR Receiver can record in stereo onto the VHS Hi-Fi audio tracks when the BROADCAST TYPE option is in the STEREO position. The DVD/VCR Receiver will also record mono audio onto the mono audio track.

If only SAP appears on the TV screen.

Set the BROADCAST TYPE option to SAP.

If STEREO/SAP appears on the TV screen

Use the BROADCAST TYPE option to select the desired recording mode (STEREO or SAP).

SAP (Second Audio Program) Recording

Some stations transmit a Second Audio Program, which is used for a second language or additional information. When the station broadcasts a Second Audio Program, follow the procedure below to record the SAP.

1 Insert a video cassette with the safety tab intact.

2 Set the BROADCAST TYPE option to SAP (SETUP menu).

Do this if only SAP appears on the TV screen or you know the program will use the SAP.

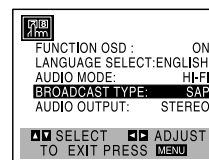

3 Press MENU.

4 Select the desired recording speed (SP or SLP) with the SP/SLP button.

5 Select the desired channel. SAP should appear on the TV screen.

6 Press REC/TR (●) once

You are now recording the program you see and hear on the TV.

7 Within 5 seconds, press STOP twice to stop recording.

VCR Operation (Continued)

Tape Counter Memory Feature

Real-Time Counter

Shows length of tape run in hours, minutes, and seconds. Press **CLK/CNT** to select the real-time counter display.

Every press of **CLK/CNT** changes the onscreen display as illustrated below.

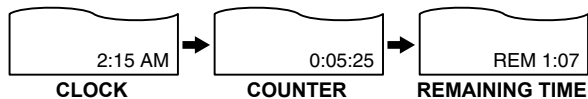

- Counter changes to "0:00:00" when the cassette is ejected.
- The real-time counter does not operate if nothing is recorded on the tape.
- The real-time counter will not work unless a tape is inserted.

Note

While in "L1 OPT" mode, the OSD(Onscreen Display) can not be changed.

Counter Memory Feature

This is useful if there is a section of tape you want to view immediately after recording or if you want to return to the same point several times.

- 1** Begin recording or playing a tape.
- 2** Press **CLK/CNT** repeatedly to display the real-time counter on the TV screen.
- 3** At the point that you want to locate later, reset the real-time counter to "0:00:00" by pressing **CLEAR**.
- 4** Continue to play or record.
- 5** Press **STOP** when recording or playback finishes.
- 6** Press **BACKWARD**.
The tape automatically stops when the tape counter returns to about "0:00:00".

Tape Remaining

This function shows the remaining time on the tape during recording or playback.

Press **CLK/CNT** repeatedly until the REM indicator appears on the TV screen during recording or playback.

Note

The remaining tape length indicator may not be displayed correctly depending on the condition of the tape and the kind of the tape (T-140, T-160, or T-210 etc)

Additional Information

- In manual recording, Timer recording, Instant Timer Recording, playback, or fast forward modes, the DVD/VCR Receiver automatically starts rewinding the tape when the end of the tape is reached. The cassette will stop and be ejected when the tape reaches the beginning. The DVD/VCR Receiver will turn itself off.
- After you have finished using the DVD/VCR Receiver, rewind, eject, and remove the cassette. Place the cassette in its protective sleeve to protect it from dust. It is not necessary to rewind the cassette before removing it, but if you do, it will be ready to play or record the next time you use it.
- Be sure the DVD/VCR Receiver Channel Selector is tuned to the correct channel you wish to record. The channel that is being recorded can always be checked by tuning the television to the DVD/VCR Receiver channel (3 or 4) and using the **TV/VCR** button on the DVD/VCR Receiver to select VCR mode (VCR MODE appears in the display window).
- Do not attempt to hook up more than one television set to the DVD/VCR Receiver for either recording or playback.

Auto Play System

This DVD/VCR Receiver features automatic playback. Load a cassette (with the safety tab removed).

- The Output Source is changed to VCR mode automatically.
- The power turns on automatically and playback begins.
- At the end of the tape, the DVD/VCR Receiver stops and rewinds the tape.
- The cassette is ejected after rewinding and the VCR turns itself off automatically.

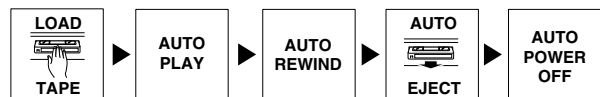

Note

Auto power off does not function during regular DVD play mode. (DVD/VCR Receiver power stays on.)

DVD Operation

Playing DVDs

Playback Setup **DVD**

- Turn on the TV and select the video input source connected to the DVD/VCR Receiver.
- Audio system: Turn on the audio system and select the input source connected to the DVD/VCR Receiver.
- Set the Output Source to DVD as shown in "Selecting Input/Output Sources" on page 15.

1 Press OPEN/CLOSE () to open the disc tray.

2 Load your chosen disc in the tray, with the label facing up.

When a double-sided DVD is inserted, make sure the side you want to play is facing down.

3 Press OPEN/CLOSE () to close the tray.





Playback starts automatically. If playback does not start, press PLAY.

In some cases, the disc menu might appear instead.

If a menu screen is displayed

A menu screen may appear automatically after loading a DVD.

DVD

Use / / /  buttons to select the title/chapter you want to view, then press MEMORY/ENTER to start playback.

Press TITLE or DISC MENU to return to the menu screen.

Notes

- If Parental Control is set and the disc is not within the Rating settings (not authorized), the 4-digit password must be entered and/or the disc must be authorized (see "Parental Control", on page 23).
- DVDs may have a Region Code. Your DVD/VCR Receiver will not play discs that have a Region Code different from your DVD/VCR Receiver. The Region Code for this DVD/VCR Receiver is 1 (one).
- Do not keep a fixed image displayed on the screen for a long time.

General Features

Note

Unless stated otherwise, all operations described use the remote control. Some features may also be available on the Setup menu.

Selecting TITLES **DVD** 1/3



If a disc has more than one title, you can select another title as follows:

- Press DISPLAY in Stop mode, then use the number buttons (0-9) to select the title number.

Selecting CHAPTERS

DVD 1/12









If a title on a disc has more than one chapter, you can select another chapter as follows:

- Press BACKWARD or FORWARD briefly during playback to return to the beginning of the current chapter or to select the next chapter.
- Press BACKWARD twice briefly to step back to the previous chapter.
- To go directly to any chapter during playback, press DISPLAY. Use /  to select Chapter icon. Then, enter the chapter number with the number buttons (0-9). Then, press MEMORY/ENTER.

Note

For two-digit numbers, press the numbered buttons (0-9) in rapid succession.

Slow Motion **DVD**

1. Press PAUSE/STEP during playback. The DVD/VCR Receiver will enter PAUSE mode.
2. Press BACKWARD or FORWARD while in Pause mode. The DVD/VCR Receiver will enter SLOW mode.
3. Use BACKWARD or FORWARD to select the required speed:  1/16,  1/8,  1/4,  1/2 (backward), or  1/16,  1/8,  1/4,  1/2 (forward).
4. To return to playback, press PLAY.

Still Picture and Frame-by-Frame Playback **DVD**

1. Press PAUSE/STEP during playback. The DVD/VCR Receiver will go into PAUSE mode.
2. With a DVD, you can advance the picture frame by frame by pressing PAUSE/STEP repeatedly on the remote control.
3. To return to playback, press PLAY.

DVD Operation (Continued)

General Features (Continued)

Search **DVD**

1. Press and hold BACKWARD or FORWARD for about two seconds while in playback.
The DVD/VCR Receiver will enter SEARCH mode.
2. Press and hold BACKWARD or FORWARD repeatedly to select the required speed: ◀◀X2, ◀◀X4, ◀◀X16, ◀◀X100 (backward) or ▶▶X2, ▶▶X4, ▶▶X16, ▶▶X100 (forward).
3. To return to playback, press PLAY.

Random **Karaoke DVD**

1. Press RANDOM while in Playback or Stop mode.
The unit automatically begins Random Playback and "RANDOM" appears on the TV screen.
2. To return to normal playback, press RANDOM until "NORMAL" appears on the TV screen.

Tips

By pressing BACKWARD or FORWARD while in Random playback, the unit selects the next title (track) and resumes Random playback.

Note

This function only works with DVD Karaoke discs.

Repeat **DVD**



DVD Video Discs - Repeat Chapter/Title/Off

1. To repeat the currently playing chapter, press REPEAT.
The Repeat Chapter icon appears on the TV screen.
2. To repeat the title currently playing, press REPEAT a second time.
The Repeat Title icon appears on the TV screen.
3. To exit Repeat mode, press REPEAT a third time.
The Repeat Off icon appears on the TV screen.

Repeat A-B **DVD**



To repeat a sequence in a title:

1. Press A-B at your chosen start point.
"A *" appears briefly on the TV screen.
2. Press A-B again at your chosen end point.
"A B" appears briefly on the TV screen, and the repeat sequence begins.
3. To cancel the sequence, press A-B.

Time Search **DVD**



The Time Search function allows you to start playing at any chosen time on the disc.

1. Press DISPLAY during playback. The on-screen display appears on the screen.
The Time Search box shows the elapsed playing time of the current disc.
2. Within 10 seconds, use ▲/▼ to select the Time Search icon in the on-screen display.
The "--:--" appears in the Time Search box.
3. Within 10 seconds, use the numbered buttons to enter the required start time. Enter hours, minutes and seconds from left to right in the box.
If you enter the wrong numbers, press CLEAR to remove the numbers you entered. Then enter the correct numbers.
4. Within 10 seconds, press MEMORY/ENTER.
Playback starts from the selected time on the disc. If you enter an invalid time, playback will continue from the current point.

3D Surround **DVD**



This unit can produce a 3D Surround effect, which simulates multi-channel audio playback from two conventional stereo speakers, instead of the five or more speakers normally required to listen to multi-channel audio from a home theater system.

1. Press SOUND MODE to select "3D SUR" during playback.
2. To turn off the 3D Surround effect, press SOUND MODE again to select "BYPASS".

Zoom **DVD**

The Zoom function allows you to enlarge the video image and to move through the enlarged image.

1. Press ZOOM during playback or still playback to activate the Zoom function.
If you press ZOOM repeatedly, the magnification level increases up to six steps.
2. Use ◀/▶/▲/▼ buttons to move through the zoomed picture.
3. Press CLEAR to resume normal playback or return to the paused image.

Notes

- The Zoom function may not work on some DVDs.
- The Zoom function may not work with some multi-angle scenes.

DVD Operation (Continued)

General Features (Continued)

Marker Search **DVD**



You can start playback from a memorized point. Up to nine points can be memorized.

To enter a mark, follow these steps.

1. During disc playback, press **MARKER** when the DVD reaches the spot that you want to memorize.
The Marker icon will appear on the TV screen briefly.
2. Repeat step 1 to enter up to nine Marker points on a disc.

To Recall a Marked Scene

1. During disc playback, press **SEARCH**.
The Marker Search menu will appear on the screen.
2. Within 10 seconds, use **◀▶** or number button to select a Marker number that you want to recall.
3. Press **MEMORY/ENTER**.
Playback will start from the Marked scene.
4. To remove the **MARKER SEARCH** menu, press **SEARCH**.

To Clear a Marked Scene

1. During disc playback, press **SEARCH**.
The Marker Search menu will appear on the screen.
 2. Within 10 seconds, use **◀▶** or number button to select a Marker number that you want to erase.
 3. Press **CLEAR**.
The Marker number will be erased from the list.
 4. Repeat steps 2 and 3 to erase additional Marker numbers.
 5. To remove the **MARKER SEARCH** menu, press **SEARCH**.
- All markers are erased when the disc is ejected.

Changing Video Mode **DVD**

- With certain discs, the playback picture may be flickering or Dot Crawl is shown on straight lines. That means Vertical interpolation or De-interlace is not perfectly matched with the disc. In this case, the picture quality may be improved by changing the video mode.
- To change the video mode, press and hold **DISPLAY** about 3 seconds during disc playback. The new video mode number selected is displayed on the TV screen. Check whether the video quality has improved. If not, repeat the above procedure until picture quality is improved.
- Video mode sequence:
MODE1 → MODE2 → MODE3 → MODE1
- If you turn off the power, the video mode will return to initial default state (MODE1).

Detailed Description of each Video Mode

MODE1 : The source material of the DVD video (film material or video material) is determined from disc information.

MODE2 : Suitable for playing film based content or video based material recorded by the progressive scan method.

MODE3 : Suitable for playing video based content with comparatively little motion.

Note

The video mode setting only works when the Progressive Scan mode is set to "On" in the Setup menu.

Special DVD Features

Checking the contents of DVD Video discs: Menus

DVDs may contain menus that allow you to access special features. To use the disc menu, press **DISC MENU**. Then, use the appropriate number button(s) to select an option. Or, use **◀▶/▲▼** buttons to highlight your selection, then press **MEMORY/ENTER**.

Title Menu **DVD**

1. Press **TITLE**.
If the current title has a menu, the menu will appear on the screen. Otherwise, the disc menu may appear.
2. The menu can list camera angles, spoken language and subtitle options, and chapters for the title.
3. To remove the title menu, press **TITLE** again.

Disc Menu **DVD**

1. Press **DISC MENU**.
The disc menu is displayed.
2. To remove the disc menu, press **DISC MENU** again.

Camera Angle **DVD**

If the disc contains sequences recorded from different camera angles, the angle icon blinks on the TV screen. You can then change the camera angle if you wish.

- Press **ANGLE** repeatedly during playback to select a desired angle.
The number of the current angle appears on the display.

Changing the Audio Language **DVD**



Press **AUDIO** repeatedly during playback to hear a different audio language or audio track.

Subtitles **DVD**

Press **SUBTITLE** repeatedly during playback to see the different subtitle languages.

Note

If  appears, the feature is not available on that specific DVD.

Screen Saver

The screen saver picture appears if you leave the DVD/VCR Receiver in Stop mode for about 5 minutes.

Audio CD and MP3 Disc Operation

Playing Audio CDs or MP3 Discs

CD **MP3**

The DVD/VCR Receiver can play MP3 formatted recordings on CD-ROM, CD-R, or CD-RW discs. Before playing MP3 recordings, read the notes on MP3 Recordings on right.

1 Insert a disc and close the tray.

Audio CD: Audio CD menu appears on the TV screen go to step 4.

MP3 disc: The MP3/JPEG menu appears on the TV screen. Go to step 2



2 Use ▲/▼ to select the MP3 option then press MEMORY/ENTER.

The MP3 menu appears on the TV screen. Press RETURN to go to the MP3/JPEG menu.

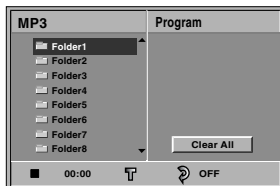

3 Use ▲/▼ to select a folder, and MEMORY/ENTER.

A list of files in the folder appears.

4 Use ▲/▼ to select a track then press PLAY or MEMORY/ENTER.

Playback starts.

During playback, the current track's elapsed playing time will appear on the display window and menu.

Playback will stop at the end of the disc.

Press TITLE to move to the next page.

Press DISC MENU to return to the previous page.

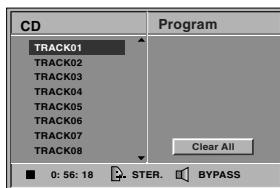

Audio CD Menu

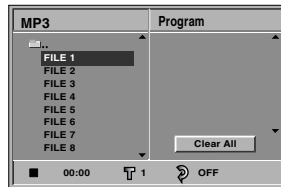

MP3 Menu



If you are in a file list and want to return to the Folder list, use the ▲/▼ to highlight  and press MEMORY/ENTER to return to the previous menu screen.

5 To stop playback at any other time, press STOP.

MP3 Recording Notes

About MP3

- An MP3 file is audio data compressed by using the MPEG1 audio layer-3 file-coding scheme. We call files that have the “.mp3” file extension “MP3 files”.
- The player can not read an MP3 file that has a file extension other than “.mp3”.

MP3 Disc compatibility with this player is limited as follows:

1. Sampling Frequency / only at 44.1kHz.
2. Bit rate / within 32 - 320kbps.
3. CD-R physical format should be “ISO 9660”
4. If you record MP3 files using the software which cannot create a FILE SYSTEM, for example “Direct-CD” etc., it is impossible to playback MP3 files. We recommend that you use “Easy-CD Creator”, which creates an ISO9660 file system.
5. A single session disc requires MP3 files in the first track. If there is no MP3 file in the 1st track, it cannot playback MP3 files. If you wish to playback MP3 files, format all the data in the disc or use a new one.
6. File names should be named using 8 letters or less and must incorporate “.mp3” extension e.g. “*****.MP3”.
7. Do not use special letters such as “/ : * ? “ < > ” etc.
8. Total number of files on the disc should be less than 650.

This DVD/VCR Receiver requires discs/recordings to meet certain technical standards in order to achieve optimal playback quality. Pre-recorded DVDs are automatically set to these standards. There are many different types of recordable disc formats (including CD-R containing MP3 files). They require certain pre-existing conditions (see above) to insure compatible playback.

Customers should also note that permission is required in order to download MP3 files and music from the Internet. Our company has no right to grant such permission. Permission should always be sought from the copyright owner.

Audio CD and MP3 Disc Operation (Continued)

Pause **CD** **MP3**

1. Press PAUSE/STEP during playback.
2. To return to playback, press PLAY or press PAUSE/STEP again.

Selecting Tracks **CD** **MP3**

- Press BACKWARD or FORWARD briefly during playback to go to the next track or to return to the beginning of the current track.
- Press BACKWARD twice briefly to step back to the previous track.
- On Audio CDs, to go directly to any track, enter the track number using the numbered buttons (0-9) while in playback.

Repeat Track/All/Off **CD** **MP3**

1. To repeat the track currently playing, press REPEAT. The Repeat icon and "TRACK" appears on the menu screen.
2. To repeat all tracks on a disc, press REPEAT a second time. The Repeat icon and "ALL" appears on the menu screen.
3. To cancel Repeat mode, press REPEAT a third time. The Repeat icon and "OFF" appear on the menu screen.

Search **CD** **MP3**

1. Press and hold BACKWARD ◀◀ or FORWARD ▶▶ for about two seconds during playback. The player will enter SEARCH mode.
2. Press and hold BACKWARD or FORWARD repeatedly to select the required speed: ◀◀X2, ◀◀X4, ◀◀X8 (backward) or ▶▶X2, ▶▶X4, ▶▶X8 (forward). Search speed and direction are indicated on the menu screen.
3. To exit SEARCH mode, press PLAY.

Random **CD** **MP3**

1. Press RANDOM during playback or in Stop mode. The unit automatically begins Random Playback and RANDOM or "RAND." appears on the display window and menu screen.
2. To return to normal playback, press RANDOM repeatedly until RANDOM or "RAND." disappears from the display window and menu screen.

Repeat A-B **CD**

To repeat a sequence.

1. During disc playback, press A-B at your chosen start point. The Repeat icon and "A * " appear on the menu screen.
2. Press A-B again at your chosen end point. The Repeat icon and "A B" appear on the menu screen, and the sequence begins to play repeatedly.
3. To exit the sequence and return to normal play, press A-B again. The Repeat icon and "OFF" appears on the menu screen.

3D Surround **CD**

This unit can produce a 3D Surround effect, which simulates multi-channel audio playback from two conventional stereo speakers, instead of the five or more speakers normally required to listen to multi-channel audio from a home theater system.

1. Press SOUND MODE to select "3D SUR" during playback.
2. To turn off the 3D Surround effect, press SOUND MODE again to select "BYPASS".

Changing the Audio Channel **CD**

Press AUDIO repeatedly during playback to hear a different audio channel (STER., LEFT, or RIGHT).

JPEG File Operation

Viewing JPEG Files on a Disc **JPEG**

This DVD/VCR Receiver can play discs with JPEG files. Before playing JPEG files, read the notes on JPEG Files to the right.

- 1 Insert a disc and close the tray.**
The MP3/JPEG menu appears on the TV screen.



- 2 Use ▲/▼ to select the JPEG option then press MEMORY/ENTER.**

The JPEG menu appears on the TV screen.



- 3 Use ▲/▼ to select a folder, and press MEMORY/ENTER.**

A list of files in the folder appears.
Press RETURN to go to the MP3/JPEG menu.

Tip

If you are in a file list and want to return to the Folder list, use the ▲/▼ buttons on the remote to highlight “⋮” and press MEMORY/ENTER to return to the previous menu screen.

- 4 If you want to view a particular file, use ▲/▼ to highlight the file and press MEMORY/ENTER or PLAY.**

Viewing the file function starts.
While viewing a file, press RETURN to move to the previous menu (JPEG menu).
Press TITLE to move to the next page.
Press DISC MENU to move to the previous page.

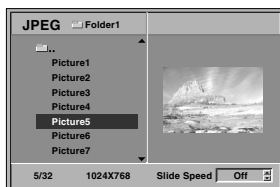

Tip

There are three viewing Slide Speed options: Fast, Normal, Slow, and Off. Use ◀▶ to highlight Slide Speed then use ▲/▼ to select the option you want to use, and then press MEMORY/ENTER.

- 5 To stop viewing at any other time, press STOP.**
The JPEG menu appears.

Selecting other Files

Press BACKWARD or FORWARD once while viewing a picture to advance to the next file or to return to the previous file.

Still Picture

- Press PAUSE/STEP during slide show.
The player will now go into PAUSE mode.
- To return to the slide show, press PLAY or press PAUSE/STEP again.

To flip the picture

Use ▲/▼ to flip the picture horizontally or a vertically.

To rotate the picture

Use ◀▶ to rotate the picture clockwise or counter clockwise.

Notes on JPEG Files

- Depending upon the size and number of the JPEG files, it could take a long time for the DVD player to read the disc's contents. If you don't see an on-screen display after several minutes, some of the files are too big — reduce the resolution of the JPEG files to less than 3072 x 2048 pixels and burn another disc.
- Total number of files and folders on the disc should be less than 650.
- Some disc may be incompatible due to different recording format or condition of disc.
- When you are using software such as “Easy CD Creator” to burn the jpeg files into the CD-R, ensure that all the selected files have the “.jpg” extensions when copying into the CD layout.
- If the files have “.jpe” or “.jpeg” extensions, please rename them as “.jpg” files.
- File names without the “.jpg” extension will not be able to be read by this DVD/VCR Receiver, even though the files are shown as JPEG image files in windows explorer.

Programmed Playback **CD** **MP3**

Programmed Playback with Audio CDs or MP3 Discs

The Program function enables you to store your favorite tracks from any disc in the player memory.

Program can contain 30 tracks.

1 Press PROGRAM during playback or in Stop mode to enter the Program Edit mode.

The  mark will appear to the right of the word Program on the right side of the menu screen.

Note

Press PROGRAM to exit the Program Edit mode; the  mark will disappear.

2 Select a track, then press MEMORY/ENTER to place the selected track on the Program list.

3 Repeat step 2 to place additional tracks on the Program list.

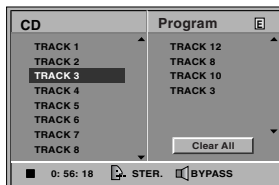

Audio CD Menu

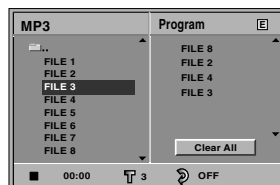

MP3 Menu

4 Press ►.

The programmed track you selected last is highlighted on the program list.

5 Use ▲/▼ to select the track you want to start playing.

Press TITLE to move to the next page.
Press DISC MENU to move to the previous page.

6 Press PLAY or MEMORY/ENTER to start.

Playback begins in the order in which you programmed the tracks and "PROG." appears on the menu screen. Playback stops after all of the tracks on the Program list have played once.

7 To resume normal playback from programmed playback, press PROGRAM. Select a track on the CD (or MP3) list and then press MEMORY/ENTER or PLAY.

"PROG." indicator disappears from the display window.

Repeat Programmed Tracks

- To repeat the track currently playing, press REPEAT. The Repeat icon and "TRACK" appear on the menu screen.
- To repeat all tracks on the program list, press REPEAT a second time. The Repeat icon and "ALL" appear on the menu screen.
- To cancel Repeat mode, press REPEAT a third time. The Repeat icon and "OFF" appear on the menu screen.

Erasing Track from the Program List

1. Press PROGRAM while in playback or Stop mode to enter the Program Edit mode.

The  mark will appear.

2. Press ► to move to the Program list.

3. Use ▲/▼ to select the track that you wish to erase from the Program list.

4. Press CLEAR.

The track will be erased from the Program list.

Erasing the Program List

1. Follow steps 1-2 of "Erasing Tracks from the Program List" as above.

2. Use ▲/▼ to select "Clear All", then press MEMORY/ENTER.

The complete Program for the disc will be erased.

Note

- The programs are cleared if the disc is removed.
- The programs are cleared if another function mode (VIDEO, radio etc.) is selected.

Speaker Setup

Adjust the following settings for the built-in 5.1 channel surround decoder.

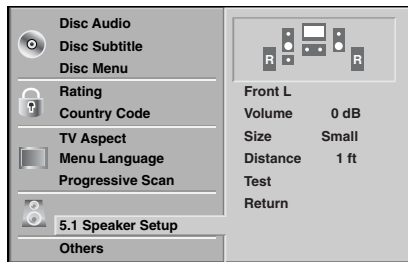

- 1** Select “5.1 Speaker Setup” on the setup menu using the ▲/▼ buttons.
- 2** While “5.1 Speaker Setup” is selected, press ► button.
- 3** Use ► buttons to select the desired speaker.
- 4** Adjust options with the ▲▼◀▶ buttons.

Speaker selection

Select a speaker that you want to adjust. ((Front speakers (Left), Center Speaker, Front speakers (Right), Rear speakers (Left), Rear speakers (Right), or Subwoofer))

Note

Certain speaker settings are prohibited by the Dolby Digital licensing agreement.

Volume

Use ◀/▶ to adjust the output level of the selected speaker. (-6dB ~ 6dB)

Size

Since the speaker settings are fixed, you cannot change the settings.

- Subwoofer’s size is fixed “Large” and the other speaker’s size are fixed “small”.

Distance

If you connected speakers to your DVD/VCR Receiver , setting the Distance lets the speakers know how far the sound has to travel to reach your set listening point. This allows the sound from each speaker to reach the listener at the same time. (1 ft = 0.30 m)

Note

You can not set the distance for the subwoofer speaker.

Test

Press MEMORY/ENTER to test the signals of each speaker. Adjust the volume to match the volume of test signals memorized in the system.

- Front Left (L) → Center → Front Right (R) → Rear Right (R) → Rear Left (L) → Subwoofer

Return

Press MEMORY/ENTER to return to the previous menu.

Radio Operation

Presetting available Radio Stations

You can preset 30 stations for FM and AM. Before tuning, make sure that you have turned down the volume.

- 1 Press **FM/AM** on the remote control or on the front panel until the frequency band appears on the display and TV screen.

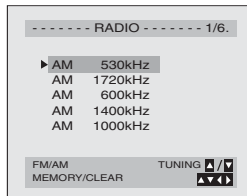

AM 530

- 2 Use **▲/▼** on the remote control or front panel to select the desired Station.

If you select a blank column, R-SKIP appears in the display window.

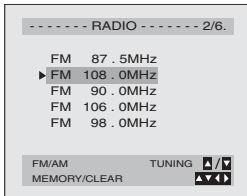

FM 108.0

- 3 Use **FM/AM** on the remote control or front panel to select the desired band.
- 4 Hold down **▼ TUNING ▲** on the front panel or on the remote control for 1 or 2 seconds, a station is searched for automatically.
- 5 Press **MEMORY/ENTER** on the remote control to store the station.
The station is stored.

MEM=108.0

- 6 Repeat steps 2 to 5 to store other stations.

Listening to the Radio

Preset available radio stations into the DVD/VCR Receiver memory first (see "Presetting Radio Stations" on the left).

- 1 Press **FM/AM** on the remote control or on the front panel until the frequency band appears on the display and TV screen.

The last received station is tuned in.

- 2 Press **▲/▼** on the remote control repeatedly to select the preset station you want.

Each time you press the button, the DVD/VCR Receiver tunes in the next preset station.

- 3 Adjust the sound level by rotating **VOLUME** on the front panel or with **VOLUME +** or **-** on the remote control.

To Clear Stored Radio Stations

- 1 Press **FM/AM** on the remote control or on the front panel until the frequency band appears on the display and TV screen.

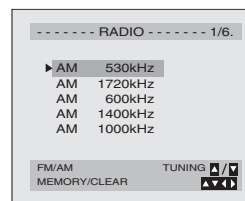

AM 530

- 2 Use **▲/▼** on the remote control to select your desired station.

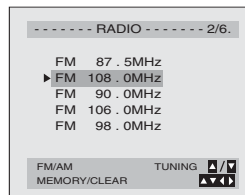

FM 108.0

- 3 Press **CLEAR** the remote control to clear the stored radio station.

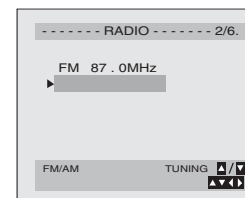

R-SKIP

Note

If in record or record pause modes, the CLEAR function may not be available.

Radio Operation (Continued)

For your reference

To turn the radio off

Press POWER to turn the DVD/VCR Receiver off or select another function mode (DVD, VCR, or AUX).

To improve reception

Realign the antenna.

Tuning into a Station Automatically

- 1** Press FM/AM on the remote control or on the front panel until the frequency band appears on the display and TV screen.
- 2** Use ▲/▼ on the remote control or front panel to select the desired column.
If you select a blank column, R-SKIP appears in the display window.
- 3** Press FM/AM on the remote control or front panel to select the desired band.
- 4** Hold down TUNING(▲/▼) on the remote control for 1 or 2 seconds, and a station is searched for automatically.
- 5** Press MEMORY/ENTER.

Note

The search may not find a station with a very weak signal.

Labeling Stations

- 1** Press ► to move to the station name column.

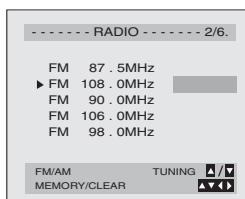

- 2** Use the ▲/▼ buttons to select the character then use the ◀▶ buttons to move to the next or previous character.
- 3** Press MEMORY/ENTER to confirm the station name.
- 4** Press MEMORY/ENTER on the remote control.
The station name is stored.

Troubleshooting

Check the following guide for the possible cause of a problem before contacting service.

Symptom	Cause	Solution
No power.	<ul style="list-style-type: none"> The power cord is disconnected. 	<ul style="list-style-type: none"> Plug the power cord into the wall outlet securely.
The power is on, but the DVD/VCR Receiver does not work.	<ul style="list-style-type: none"> No disc is loaded. No tape is loaded. 	<ul style="list-style-type: none"> Insert a disc or tape. (Check that the disc or tape indicator in the display window is lit.)
No picture.	<ul style="list-style-type: none"> The TV is not set to receive DVD/VCR Receiver signal output. 	<ul style="list-style-type: none"> Select the appropriate video input mode on the TV so the picture from the DVD/VCR Receiver appears on the TV screen.
	<ul style="list-style-type: none"> TV/VCR mode for DVD/VCR Receiver is set to TV MODE. 	<ul style="list-style-type: none"> Press the TV/VCR button on the remote control repeatedly to choose VCR mode. VCR MODE appears in the display window.
	<ul style="list-style-type: none"> The video cable is not connected securely. 	<ul style="list-style-type: none"> Connect the video cable securely.
	<ul style="list-style-type: none"> The connected TV power is turned off. 	<ul style="list-style-type: none"> Turn on the TV.
No sound.	<ul style="list-style-type: none"> The equipment connected with the audio cable is not set to receive DVD/VCR Receiver signal output. 	<ul style="list-style-type: none"> Select the correct input mode on the audio receiver so you can listen to the sound from the DVD/VCR Receiver.
	<ul style="list-style-type: none"> The audio cables are not connected securely. 	<ul style="list-style-type: none"> Connect the audio cable securely.
	<ul style="list-style-type: none"> The power of the equipment connected with the audio cable is turned off. 	<ul style="list-style-type: none"> Turn on the equipment connected with the audio cable.
	<ul style="list-style-type: none"> The audio connecting cord is damaged. 	<ul style="list-style-type: none"> Replace it with new one.
The playback picture is poor.	<ul style="list-style-type: none"> The disc is dirty. 	<ul style="list-style-type: none"> Clean the disc.
	<ul style="list-style-type: none"> Tape heads are dirty. 	<ul style="list-style-type: none"> Clean video heads.
	<ul style="list-style-type: none"> Tape is a rental or was recorded on another VCR. 	<ul style="list-style-type: none"> Use CH/TRK (▲/▼) for manual tracking adjustment while tape is playing.
The DVD/VCR Receiver does not start playback.	<ul style="list-style-type: none"> No disc is loaded. No tape is loaded. 	<ul style="list-style-type: none"> Insert a disc or tape. (Check that the disc or tape indicator in the display window is lit.)
	<ul style="list-style-type: none"> An unplayable disc is inserted. 	<ul style="list-style-type: none"> Insert a playable disc. (Check the disc type, color system, and Regional code.)
	<ul style="list-style-type: none"> The disc is placed upside down. 	<ul style="list-style-type: none"> Place the disc with the playback side down.
	<ul style="list-style-type: none"> The disc is not placed within the guide. 	<ul style="list-style-type: none"> Place the disc on the disc tray correctly inside the guide.
	<ul style="list-style-type: none"> The disc is dirty. 	<ul style="list-style-type: none"> Clean the disc.
	<ul style="list-style-type: none"> The Rating level is set. 	<ul style="list-style-type: none"> Cancel the Rating function or change the rating level.

Troubleshooting (Continued)

Symptom	Cause	Solution
Some channels are skipped over when using CH/TRK (▲/▼)	<ul style="list-style-type: none"> Those channels were deleted with the CH. ADD/DEL option. 	<ul style="list-style-type: none"> Use CH. ADD/DEL to restore channels. See "Channel Selection" on page 18.
Picture and sound of broadcasting channel are weak or missing.	<ul style="list-style-type: none"> Antenna or cables are loose. 	<ul style="list-style-type: none"> Tighten connections or replace cable.
	<ul style="list-style-type: none"> Wrong CHANNEL SOURCE option is being used. 	<ul style="list-style-type: none"> Try all CHANNEL SOURCE options. See "Channel Selection" on page 18 for details.
Camcorder image is not shown.	<ul style="list-style-type: none"> Camcorder is off. 	<ul style="list-style-type: none"> Turn camcorder on and operate properly.
Camcorder image via A/V input to DVD/CD/VCR Receiver is not shown on TV screen.	<ul style="list-style-type: none"> DVD/VCR Receiver INPUT SELECT is not set to LINE1 (L1) or LINE2 (L2). 	<ul style="list-style-type: none"> Use INPUT to select LINE input channel (LINE1 (L1) or LINE2 (L2)).
Timer recording is not possible.	<ul style="list-style-type: none"> Clock in DVD/VCR Receiver is not set to correct time. 	<ul style="list-style-type: none"> Set clock to correct time. See "Setting the Clock" on page 19.
	<ul style="list-style-type: none"> Timer has been programmed incorrectly. 	<ul style="list-style-type: none"> Reprogram Timer. See "Timer Recording" on pages 25 and 26.
	<ul style="list-style-type: none"> TIMER indicator light does not appear after programming timer. 	<ul style="list-style-type: none"> Reprogram Timer and turn DVD/VCR Receiver off to enable timer.
Stereo Audio Record and/or Playback is not present.	<ul style="list-style-type: none"> TV is not Stereo-compatible. 	<ul style="list-style-type: none"> No action is possible.
	<ul style="list-style-type: none"> Broadcast program is not in stereo format. 	<ul style="list-style-type: none"> No action is possible.
	<ul style="list-style-type: none"> DVD/VCR Receiver A/V Out jacks are not connected to TV A/V In jacks. 	<ul style="list-style-type: none"> Make A/V connections. Stereo is available only via A/V output from DVD/VCR Receiver.
	<ul style="list-style-type: none"> DVD/VCR Receiver Audio/Video Out is not selected for viewing at the TV. 	<ul style="list-style-type: none"> Select AUX or A/V source as TV input.
	<ul style="list-style-type: none"> DVD/VCR Receiver BROADCAST TYPE mode is set to SAP or MONO. 	<ul style="list-style-type: none"> Set BROADCAST TYPE mode to STEREO. See "Using the VCR Setup Menu" on page 18.

Troubleshooting (Continued)

Symptom	Cause	Correction
Severe hum or noise is heard.	• The plugs and jacks are dirty.	• Wipe them with a cloth slightly moistened with alcohol.
	• The disc is dirty.	• Clean the disc.
	• The speakers and components are connected poorly.	• Connect the speakers and components securely.
	• The DVD/VCR Receiver is located too close to the TV.	• Move your TV away from the audio components.
Radio stations cannot be tuned in.	• The antenna is positioned or connected poorly.	• Connect the antenna securely. • Adjust the antennas and connect an external antenna if necessary.
	• The signal strength of the stations is too weak (when tuning in with automatic tuning).	• Tune in the station manually.
	• No stations have been preset or preset stations have been cleared (when tuning by scanning preset stations).	• Preset the stations (page 38).
No sound from DIGITAL AUDIO IN (OPTICAL).	• DVD/VCR Receiver source is not set to DIGITAL AUDIO IN (OPTICAL).	• Select OPTICAL by pressing AUX.
The remote control does not work properly.	• The remote control is not pointed at the remote sensor of the DVD/VCR Receiver.	• Point the remote control at the remote sensor of the DVD/VCR Receiver.
	• The remote control is too far from the DVD/VCR Receiver.	• Operate the remote control within 23 ft (7 m).
	• There is an obstacle in the path of the remote control and the DVD/VCR Receiver.	• Remove the obstacle.
	• The batteries in the remote control are exhausted.	• Replace the batteries with new ones.
	• This remote control uses same buttons for VCR and DVD (ex. PLAY).	• When using the VCR, first press the VCR button. When using the DVD, first press the DVD button.

Moisture Condensation

Moisture condensation can occur:	In locations where moisture condensation may occur:
<ul style="list-style-type: none"> • When the DVD/VCR Receiver is moved from a cold place to a warm place. • Under extremely humid conditions. 	<ul style="list-style-type: none"> • Keep the DVD/VCR Receiver plugged into an AC power outlet with POWER On. This will help prevent condensation. • When condensation has occurred, wait a few hours for the DVD/VCR Receiver to dry before using it.

Language Code List

Enter the appropriate code number for the initial settings "Disc Audio", "Disc Subtitle" and/or "Disc Menu"
(See page 21).

Code	Language	Code	Language	Code	Language	Code	Language
6566	Abkhazian	7074	Fiji	7678	Lingala	8373	Singhalese
6565	Afar	7073	Finnish	7684	Lithuanian	8375	Slovak
6570	Afrikaans	7082	French	7775	Macedonian	8376	Slovenian
8381	Albanian	7089	Frisian	7771	Malagasy	8379	Somali
6577	Amharic	7176	Galician	7783	Malay	6983	Spanish
6582	Arabic	7565	Georgian	7776	Malayalam	8385	Sudanese
7289	Armenian	6869	German	7784	Maltese	8387	Swahili
6583	Assamese	6976	Greek	7773	Maori	8386	Swedish
6588	Aymara	7576	Greenlandic	7782	Marathi	8476	Tagalog
6590	Azerbaijani	7178	Guarani	7779	Moldavian	8471	Tajik
6665	Bashkir	7185	Gujarati	7778	Mongolian	8465	Tamil
6985	Basque	7265	Hausa	7865	Nauru	8484	Tatar
6678	Bengali; Bangla	7387	Hebrew	7869	Nepali	8469	Telugu
6890	Bhutani	7273	Hindi	7879	Norwegian	8472	Thai
6672	Bihari	7285	Hungarian	7982	Oriya	6679	Tibetan
6682	Breton	7383	Icelandic	8065	Panjabi	8473	Tigrinya
6671	Bulgarian	7378	Indonesian	8083	Pashto, Pushto	8479	Tonga
7789	Burmese	7365	Interlingua	7065	Persian	8482	Turkish
6669	Byelorussian	7165	Irish	8076	Polish	8475	Turkmen
7577	Cambodian	7384	Italian	8084	Portuguese	8487	Twi
6765	Catalan	7465	Japanese	8185	Quechua	8575	Ukrainian
9072	Chinese	7487	Javanese	8277	Rhaeto-Romance	8582	Urdu
6779	Corsican	7578	Kannada	8279	Romanian	8590	Uzbek
7282	Croatian	7583	Kashmiri	8285	Russian	8673	Vietnamese
6783	Czech	7575	Kazakh	8377	Samoan	8679	Volapük
6865	Danish	7589	Kirghiz	8365	Sanskrit	6789	Welsh
7876	Dutch	7579	Korean	7168	Scots Gaelic	8779	Wolof
6978	English	7585	Kurdish	8382	Serbian	8872	Xhosa
6979	Esperanto	7679	Laothian	8372	Serbo-Croatian	7473	Yiddish
6984	Estonian	7665	Latin	8378	Shona	8979	Yoruba
7079	Faeroese	7686	Latvian, Lettish	8368	Sindhi	9085	Zulu

Country Code List

Enter the appropriate code number for the initial setting "Country Code" (See page 23).

Code	Country	Code	Country	Code	Country	Code	Country
AD	Andorra	ER	Eritrea	LC	Saint Lucia	SC	Seychelles
AE	United Arab Emirates	ES	Spain	LI	Liechtenstein	SD	Sudan
AF	Afghanistan	ET	Ethiopia	LK	Sri Lanka	SE	Sweden
AG	Antigua and Barbuda	FI	Finland	LR	Liberia	SG	Singapore
AI	Anguilla	FJ	Fiji	LS	Lesotho	SH	Saint Helena
AL	Albania	FK	Falkland Islands	LT	Lithuania	SI	Slovenia
AM	Armenia	FM	Micronesia	LU	Luxembourg	SJ	Svalbard and Jan Mayen Islands
AN	Netherlands Antilles	FO	Faroe Islands	LV	Latvia	SK	Slovak Republic
AO	Angola	FR	France	LY	Libya	SL	Sierra Leone
AQ	Antarctica	FX	France (European Territory)	MA	Morocco	SM	San Marino
AR	Argentina	GA	Gabon	MC	Monaco	SN	Senegal
AS	American Samoa	GB	Great Britain	MD	Moldavia	SO	Somalia
AT	Austria	GD	Grenada	MG	Madagascar	SR	Suriname
AU	Australia	GE	Georgia	MH	Marshall Islands	ST	Saint Tome and Principe
AW	Aruba	GF	French Guyana	MK	Macedonia	SU	Former USSR
AZ	Azerbaijan	GH	Ghana	ML	Mali	SV	El Salvador
BA	Bosnia-Herzegovina	GI	Gibraltar	MM	Myanmar	SY	Syria
BB	Barbados	GL	Greenland	MN	Mongolia	SZ	Swaziland
BD	Bangladesh	GM	Gambia	MO	Macau	TC	Turks and Caicos Islands
BE	Belgium	GN	Guinea	MP	Northern Mariana Islands	TD	Chad
BF	Burkina Faso	GP	Guadeloupe (French)	MQ	Martinique (French)	TF	French Southern Territories
BG	Bulgaria	GQ	Equatorial Guinea	MR	Mauritania	TG	Togo
BH	Bahrain	GR	Greece	MS	Montserrat	TH	Thailand
BI	Burundi	GS	S. Georgia & S. Sandwich Isls.	MT	Malta	TJ	Tadjikistan
BJ	Benin	GT	Guatemala	MU	Mauritius	TK	Tokelau
BM	Bermuda	GU	Guam (USA)	MV	Maldives	TM	Turkmenistan
BN	Brunei Darussalam	GW	Guinea Bissau	MW	Malawi	TN	Tunisia
BO	Bolivia	GY	Guyana	MX	Mexico	TO	Tonga
BR	Brazil	HK	Hong Kong	MY	Malaysia	TP	East Timor
BS	Bahamas	HM	Heard and McDonald Islands	MZ	Mozambique	TR	Turkey
BT	Bhutan	HN	Honduras	NA	Namibia	TT	Trinidad and Tobago
BV	Bouvet Island	HR	Croatia	NC	New Caledonia (French)	TV	Tuvalu
BW	Botswana	HT	Haiti	NE	Niger	TW	Taiwan
BY	Belarus	HU	Hungary	NF	Norfolk Island	TZ	Tanzania
BZ	Belize	ID	Indonesia	NG	Nigeria	UA	Ukraine
CA	Canada	IE	Ireland	NI	Nicaragua	UG	Uganda
CC	Cocos (Keeling) Islands	IL	Israel	NL	Netherlands	UK	United Kingdom
CF	Central African Republic	IN	India	NO	Norway	UM	USA Minor Outlying Islands
CG	Congo	IO	British Indian Ocean Territory	NP	Nepal	US	United States
CH	Switzerland	IQ	Iraq	NR	Nauru	UY	Uruguay
CI	Ivory Coast	IR	Iran	NU	Niue	UZ	Uzbekistan
CK	Cook Islands	IS	Iceland	NZ	New Zealand	VA	Vatican City State
CL	Chile	IT	Italy	OM	Oman	VC	Saint Vincent & Grenadines
CM	Cameroon	JM	Jamaica	PA	Panama	VE	Venezuela
CN	China	JO	Jordan	PE	Peru	VG	Virgin Islands (British)
CO	Colombia	JP	Japan	PF	Polynesia (French)	VI	Virgin Islands (USA)
CR	Costa Rica	KE	Kenya	PG	Papua New Guinea	VN	Vietnam
CS	Former Czechoslovakia	KG	Kyrgyzstan	PH	Philippines	VU	Vanuatu
CU	Cuba	KH	Cambodia	PK	Pakistan	WF	Wallis and Futuna Islands
CV	Cape Verde	KI	Kiribati	PL	Poland	WS	Samoa
CX	Christmas Island	KM	Comoros	PM	Saint Pierre and Miquelon	YE	Yemen
CY	Cyprus	KN	Saint Kitts & Nevis Anguilla	PN	Pitcairn Island	YT	Mayotte
CZ	Czech Republic	KP	North Korea	PR	Puerto Rico	YU	Yugoslavia
DE	Germany	KR	South Korea	PT	Portugal	ZA	South Africa
DJ	Djibouti	KW	Kuwait	PW	Palau	ZM	Zambia
DK	Denmark	KY	Cayman Islands	PY	Paraguay	ZR	Zaire
DM	Dominica	KZ	Kazakhstan	QA	Qatar	ZW	Zimbabwe
DO	Dominican Republic	LA	Laos	RE	Reunion (French)		
DZ	Algeria	LB	Lebanon	RO	Romania		
EC	Ecuador			RU	Russian Federation		
EE	Estonia			RW	Rwanda		
EG	Egypt			SA	Saudi Arabia		
EH	Western Sahara			SB	Solomon Islands		

Specifications

General

Power requirements	AC 120V, 60 Hz
Power consumption	72W
Dimensions (approx.)	430 X 97 X 385 mm (17 x 3.9 x 15.3 inches) (w x h x d)
Weight (approx.)	6.3 kg (13.15 lbs)
Operating temperature	5°C to 35°C (41°F to 95°F)
Operating humidity	5 % to 90 %
Signal system	NTSC

Inputs

ANTENNA IN	Antenna or CATV input, 75 ohms
VCR VIDEO IN	1 Vp-p 75 ohms, sync negative, RCA jack x 2
VCR AUDIO IN	-6.0 dBm more than 47 kohms, RCA jack (L, R) x 2
FM ANTENNA IN	FM antenna input, 300 ohms
AM ANTENNA IN	AM antenna input, 300 ohms
DIGITAL AUDIO IN	5 V (p-p), 75 Ω, Optical connector x 1

Outputs

VIDEO OUT	1 Vp-p 75 ohms, sync negative
S-VIDEO OUT	(Y) 1.0 V (p-p), 75 ohms, negative sync, Mini DIN 4-pin x 1 (C) 0.286 V (p-p) 75 ohms
COMPONENT VIDEO OUT (PROGRESSIVE SCAN)	(Y) 1.0 V (p-p), 75 ohms, negative sync, RCA jack x 1 (Pb)/(Pr) 0.7 V (p-p), 75 ohms, RCA jack x 2
Audio output (analog audio)	2.0 Vrms (1 KHz, 0 dB), 600 ohms, RCA jack (L, R) x 1
RF OUT	Channel 3 or 4 (Switchable)

VCR Specifications

Head system	Four head helical scan azimuth system
Timer	12-hour display type with AM, PM
Tape speed	SP: 33.35 mm/sec, LP: 16.67 mm/sec, SLP: 11.12 mm/sec
Tape width	12.7 mm
Maximum recording time	SP: 2 HOURS (T-120), SLP: 6 HOURS (T-120)/8 HOURS (T-160)
Rewind time	About 150 seconds (T-120)
Antenna	75 ohms (VHF/UHF)
Channel coverage	VHF: 2-13, UHF: 14-69, CATV: 1-125 (4A, A-W, W+1 - W+84, A-5 - A-1)
Frequency range	20Hz to 20kHz
Signal-to-noise ratio	More than 43dB
Dynamic range	More than 85 dB (AUDIO OUT jacks)
Channel separation	More than 55 dB (AUDIO OUT jacks)

DVD Specifications

Laser system	Semiconductor laser, wavelength 650 nm
Frequency response	DVD (PCM 48 kHz): 8 Hz to 22 kHz, CD: 8 Hz to 20 kHz
Signal-to-noise ratio	More than 75 dB (AUDIO OUT jacks)
Harmonic distortion	Less than 0.4%
Dynamic range	More than 85 dB (AUDIO OUT jacks)

Specifications (Continued)

FM Tuner

Tuning Range	87.5 - 108.0 MHz
Intermediate Frequency	10.7 MHz

AM Tuner

Tuning Range	530 - 1,720 kHz
Intermediate Frequency	450 kHz

Amplifier

Stereo mode	35W + 35W (8Ω at 1 kHz, THD 10 %)
Surround mode	Front: 35W + 35W (THD 10 %) Center*: 35W Surround*: 35W + 35W (8Ω at 1 kHz, THD 10 %) Subwoofer*: 50W (8Ω at 30 Hz, THD 10 %)
Inputs	*Depending on the sound mode settings and the source, there may be no sound output. LINE 1, LINE 2, OPTICAL IN

Speakers

	Satellite Speaker	Passive Subwoofer
Type	2 Way 2 Speaker	1 Way 1 Speaker
Impedance	8 Ω	8 Ω
Frequency Response	110 - 40,000 Hz	45 - 1,500 Hz
Sound Pressure Level	83 dB/W (1m)	82 dB/W (1m)
Rated Input Power	50W	50 W
Max. Input Power	100 W	100 W
Net Dimensions (W x H x D)	100 x 147 x 127.5 mm (3.9 x 5.8 x 5.0 inches)	200 x 425 x 381 mm (7.9 x 16.7 x 15 inches)
Net Weight	0.92 kg (2.0 lbs)	7.06kg (15.6 lbs)

Accessories:

Video cable	1
Audio cable	1
Ferrite core	1
Super Video cable	1
RF 75-ohm Coaxial Cable	1
Speakers	6
Speaker cables	5
AM loop antenna	1
FM antenna	1
Remote control	1
Batteries	2

- Design and specifications are subject to change without notice.

Manufactured under license from Dolby Laboratories. "Dolby", "Pro Logic", and the double-D symbol are trademarks of Dolby Laboratories.

DTS and DTS Digital Surround are registered trademarks of Digital Theater Systems, Inc.

Notes

REFERENCE

**ZENITH ELECTRONICS CORPORATION
DVD/VCR Receiver Home Theater System XBS344
LIMITED WARRANTY-USA**

Zenith will repair or replace your product, at Zenith's option, if it proves to be defective in material or workmanship under normal use, during the warranty period ("Warranty Period") listed below, effective from the date ("Date of Purchase") of original purchase of the product. This limited warranty is good only to the original purchaser of the product and effective only when used in the United States, excluding U.S. Territories.

<p>WARRANTY PERIOD: LABOR: 90 days from the Date of Purchase. PARTS: 1 Year from the Date of Purchase. * Parts replaced are warranted for the remaining portion of the original warranty period.</p>	<p>HOW SERVICE IS HANDLED: Carry-In Service: Please retain dealer's dated bill of sale or delivery ticket as evidence of the Date of Purchase for proof of warranty, and submit a copy of the bill of sale to the service person at the time warranty service is provided. Please call 1-877-9Zenith (1-877-993-6484) to locate your nearest Zenith Authorized Service Center. Or visit our website at http://www.zenithservice.com</p>
--	---

THIS WARRANTY IS IN LIEU OF ANY OTHER WARRANTIES, EXPRESS OR IMPLIED, INCLUDING WITHOUT LIMITATION, ANY WARRANTY OF MERCHANTABILITY OR FITNESS FOR A PARTICULAR PURPOSE. TO THE EXTENT ANY IMPLIED WARRANTY IS REQUIRED BY LAW, IT IS LIMITED IN DURATION TO THE EXPRESS WARRANTY PERIOD ABOVE. ZENITH WILL NOT BE LIABLE FOR ANY INCIDENTAL, CONSEQUENTIAL, INDIRECT, SPECIAL, OR PUNITIVE DAMAGES OF ANY NATURE, EVEN IF ADVISED OF THE POSSIBILITY OF SUCH DAMAGES, INCLUDING WITHOUT LIMITATION, LOST REVENUES OR PROFITS, LOST OR CORRUPTED PROGRAMMING OR DATA, OR ANY OTHER DAMAGE WHETHER BASED IN CONTRACT, TORT, OR OTHERWISE.

Some states do not allow the exclusion or limitation of incidental or consequential damages or limitations on how long an implied warranty lasts, so the above exclusion or limitation may not apply to you. This warranty gives you specific legal rights and you may also have other rights that vary from state to state.

THIS LIMITED WARRANTY DOES NOT APPLY TO:

- Damage caused in shipping or transit
- Service required as a result of improper installation, including incorrect or insufficient AC supply (Please consult the owner's manual for power supply requirements)
- Installation or repair of other components in a video system
- Set-up or adjustment on consumer controls, or damage caused by improper adjustments
- Damage cause by other system components
- Damage (including cosmetic damage), failure, loss or personal injury due to misuse, abuse, negligence, improper maintenance or storage, or to acts of nature or other causes beyond Zenith's control (Causes beyond Zenith's control include but are not limited to lightning strike, power surges, power outages, and water damage)
- Repair or replacement of warranted parts by other than Zenith Authorized Service Centers
- Units purchased or serviced outside the coverage area
- Product where the original factory serial numbers have been removed, defaced, or changed in any way
- Product sold and labeled as "as is, where is" or similar disclaimer

The costs of repair or replacement under these excluded circumstances shall be borne by the consumer.

CUSTOMER INTER-ACTIVE CENTER NUMBERS:

<p>For nearest Authorized Service Center, Where to buy, Product Assistance, or Customer Assistance</p>	<p>Call 1-877-9Zenith (1-877-993-6484) (Monday - Friday, 7 AM - 8 PM CT; and Saturday, 8 AM - 5 PM CT) and select an appropriate option from the menu. Or visit our website at http://www.zenithservice.com</p>
---	---

ZENITH ELECTRONICS CORPORATION
2000 MILLBROOK DRIVE
LINCOLNSHIRE, IL 60069

Zenith Part No. 206-3871
GS# 3835RM0058Q
Printed in Indonesia
Issue O

Free Manuals Download Website

<http://myh66.com>

<http://usermanuals.us>

<http://www.somanuals.com>

<http://www.4manuals.cc>

<http://www.manual-lib.com>

<http://www.404manual.com>

<http://www.luxmanual.com>

<http://aubethermostatmanual.com>

Golf course search by state

<http://golfingnear.com>

Email search by domain

<http://emailbydomain.com>

Auto manuals search

<http://auto.somanuals.com>

TV manuals search

<http://tv.somanuals.com>