

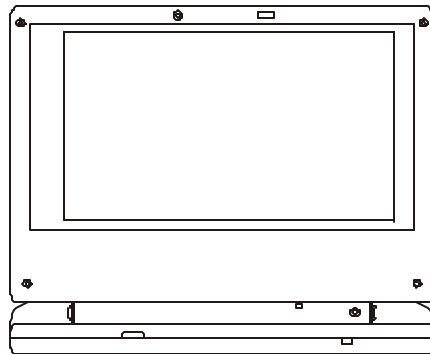

AUDIOVOX[®]
ELECTRONICS CORP.



D1705

PORTABLE 7" LCD MONITOR AND DVD PLAYER



For Customer Service
Visit Our Website At
www.audiovox.com
Product Information, Photos,
FAQ's Owner's Manuals

1286808

Notice:

This Product incorporates copyright protection technology that is protected by method claims of certain patents and other intellectual property rights owned by Macrovision Corporation and other rights owners. Use of this copyright protection technology must be authorized by Macrovision Corporation, and is intended for home and other limited viewing uses only unless authorized by Macrovision Corporation. Reverse engineering or disassembly is prohibited.

A. Introduction

Thank you for selecting the D1705 portable DVD player. The main features include a 7" Wide Screen (16:9 Aspect Ratio) Liquid Crystal Display (LCD) monitor and a DVD player. The unit applies the latest state of the art electronics and is designed for use in hotels, offices or your home. The unit is constructed to provide years of reliable, trouble-free service, and is compact so that you can take it with you anywhere and is designed for quick and easy installation. Please read the entire instruction manual supplied with this product prior to operation. The documentation will assist you in installing the system properly to obtain the best equipment performance. Please retain this manual for later use.

B. Cautions and Warnings

1. Placement

To prevent fire or electric shock, do not expose this appliance to rain or moisture. Do not place the set on an unstable cart, stand, tripod, bracket or table to prevent it from falling. Keep the unit away from strong magnets, heat sources, direct sunlight, excessive dust. If the unit is brought directly from a cold to a warm location, moisture may condense inside the unit. When you move it from a cold to a warm location, wait for about one hour before operating the unit, or remove the disc and leave the unit turned on until the moisture evaporates.

2. Installation

Ensure that the D1705 is installed in accordance with the instructions and illustrations provided in this manual.

3. Object and Liquid

Do not push objects of any kind into the unit through openings; do not spill or spray liquid of any kind on or in the system (this may result in a fire or electric shock). Do not place anything heavy on the unit. To ensure proper ventilation and proper operation, never cover or block the slots and openings with a cloth or other material.

4. Disassemble

Do not attempt to disassemble the cabinet. There is a risk of electric shock and/or exposure to Laser Radiation. Contact qualified service personnel if your system is in need of repair.

5. Cleaning Unit

When cleaning, make sure the system is unplugged from the power source. Do not use liquid cleaners or aerosol cleaners. Use a cloth lightly dampened with water for cleaning the exterior of the system only.

6. Disc

Do not use irregularly shaped discs such as heart or star-shaped discs as they may cause the unit to malfunction. Do not stick paper, tape or glue on the disc. Do not expose the disc to direct sunlight or heat sources such as hot air ducts. Do not touch the surface of disc. Handle the disc by its edge. Clean the disc by wiping the disc from the center out with a cleaning cloth. Remove the disc from the unit and store it in its case after playing. Some playback operations of discs may be intentionally fixed by software producers. Since this unit plays discs according to the disc contents the software producers designed, some playback features may not be available. Also refer to the instructions supplied with the discs.

C. Contents

1. 1 x 7.0" LCD Monitor & DVD Player Combo
2. 1 x AC to DC Adapter
3. 1 x Rechargeable Battery
4. 1 x Remote Control
5. 1 x Instruction Manual
6. 1 x Audio/Video Cable
7. 1 x Cigarette Lighter Adapter

D. Powering and installation

1. Powering the system indoors (Refer to Figure 1)

Plug one end of the AC to DC adapter into the DC 9V jack on the left side of the main unit, then plug the other end into the 110V AC power socket.

2. Powering the system in a car

Plug one end of the cigarette lighter adapter into the DC 9V jack on the unit, then plug the other end into the cigarette lighter socket.

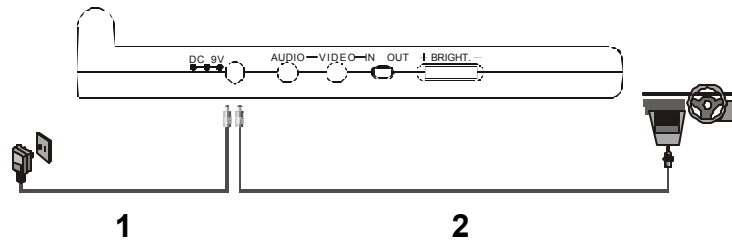

Figure 1

E. Controls, Indicators, and Connectors

1. Unit View (Refer to Figure 2)

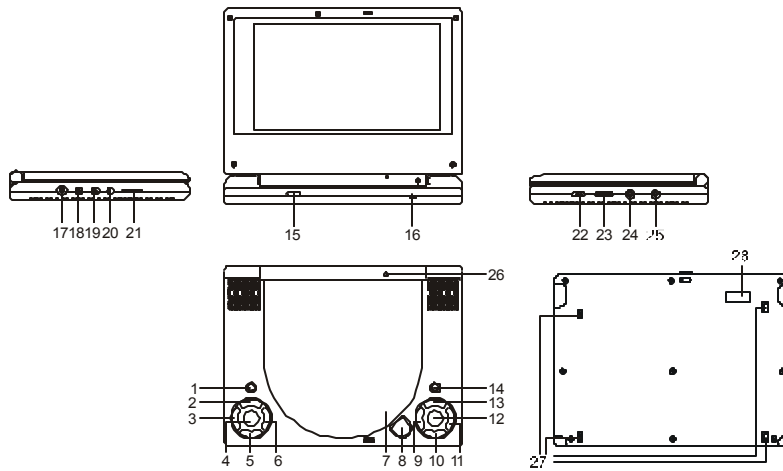

Figure 2

- 1) Menu
- 2) Up button
- 3) Left Button
- 4) OK Button
- 5) Down Button
- 6) Right Button
- 7) Close disc cover point
- 8) Open Button
- 9) Previous Button
- 10) Stop Button
- 11) Next Button
- 12) Play Button
- 13) Pause Button
- 14) Screen Mode (wide) Button
- 15) Remote Control Sensor
- 16) Power LED
- 17) DC 9V Input Jack
- 18) Audio Jack (L+R)
- 19) Video Jack
- 20) AV Input /Output Switch
- 21) Brightness Up/Down Thumbwheel
- 22) Power On/ Off Switch
- 23) Volume Up/Down Thumbwheel
- 24) Hi-Fi Headphone Jack
- 25) Coaxial Jack
- 26) Power Saving Mode Switch (Screen closed shut off switch)
- 27) Battery Catch
- 28) Battery Port

2. Remote Control View (Refer to Figure 3)

- 1) Display Button
- 2) Angle Button
- 3) Subtitle Button
- 4) Audio Button
- 5) Zoom Button
- 6) Up/Down/Left/Right/Enter Buttons
- 7) Return Button
- 8) A-B Button
- 9) Forward Button
- 10) Reverse Button
- 11) Slow Button
- 12) Stop Button
- 13) Number Buttons
- 14) Setup Button
- 15) Menu Button
- 16) Repeat Button
- 17) SKIP-
- 18) SKIP+
- 19) Play Button
- 20) Pause Button

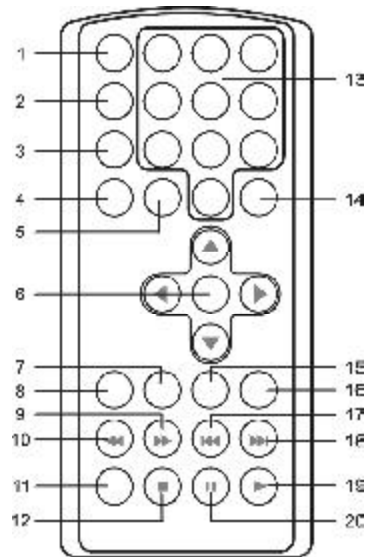

Figure 3

F. Loading and Playing a Disc

- a. After connecting power to the unit, power on "DVD player" with the power switch.
- b. Open the disc tray by pressing OPEN , place a disc into the tray with label side of disc facing up.
- c. Close the tray by pressing "PRESS" button. The unit will load the disc and go to the root menu. Start playback by pressing "PLAY".
- d. Rotate the BRIGHT and VOLUME controls to adjust the picture brightness and the DVD player's volume.
- e. To stop playing a disc, press STOP.

G. SETUP

Press 'SETUP' to display the Main screen of the SETUP Menu on the screen. Press 'SETUP' again to exit the SETUP Menu.

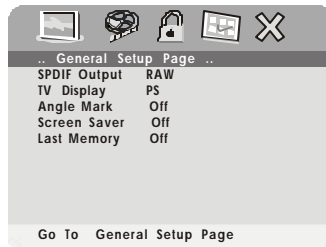

Figure 4. Main SETUP Menu Screen

- 1) Select 'GENERAL SETUP' using the Left /Right buttons, then press 'ENTER' to enter the GENERAL Setup screen.

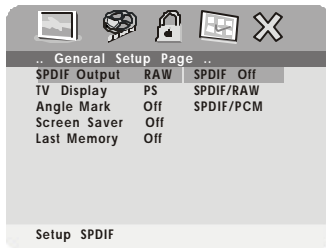

Figure 5. General SETUP Menu Screen

- a) Select "SPDIF Output RAW" use this option to select the audio signal output from "Coaxial" port.
 - * SPDIF OFF: the digital signal Audio output will be off.
 - * SPDIF/RAW: the signal output from "COAXIAL" is RAW.
 - * SPDIF/PCM: the signal output from "COAXIAL" is PCM.
- b) Select TV DISPLAY using UP/DOWN, and then press RIGHT to enter the submenu. Select the TV display mode on the screen using UP/DOWN, and press ENTER to confirm the setting. Press LEFT to return.
 - * NORMAL/PS: When the player is connected to a normal TV, and a wide picture is shown on the full screen.
 - * NORMAL/LB: When the player is connected to a normal TV,

and a wide picture is shown on the screen with a black strip at both the top and bottom of the screen.

* WIDE: When the player is connected to a wide screen TV, a wide picture is shown on the full screen.

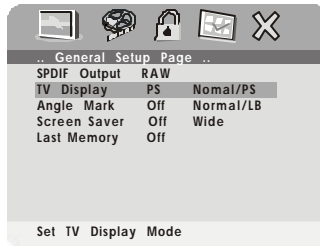

Figure 6. TV DISPLAY Screen Display

c). Select 'ANGLE MARK' using UP/DOWN, and then press the RIGHT button to enter the submenu. Choose Angle Mark on or off displayed on the screen using the UP/DOWN and then press ENTER to confirm the setting. Press the LEFT button to return.

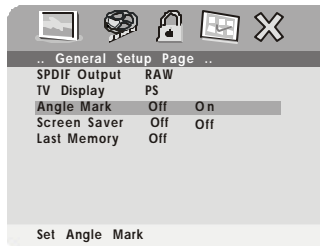

Figure 7. ANGLE MARK Screen Display

* ON: The screen will show angle mark.
(*If angle option is available)

OFF: The screen will not display the Angle Mark

d). Select 'SCREEN SAVER' using UP/DOWN key,

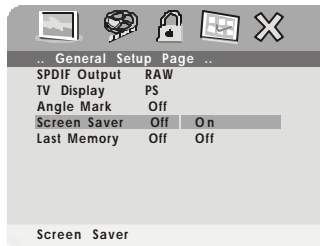

Figure 8. SCREEN SAVER Display

*ON: screen saver on.

*OFF: screen saver off.

***NOTE** The DVD player will enter the Screen Saver mode after 5 minutes if the image on the screen remains the same for more than 5 minutes.

e). Select “ Last Memory’ by Up/Down button

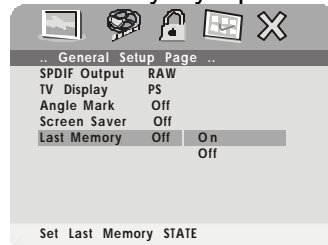

Figure 9. LAST MEMORY Screen Display

*on: The unit will retain the last position of playback in memory. This feature is cancelled when power is turned off.

*off: The unit will not retain the last position of playback.

2) Select “Video quality” set up by using the left/right buttons, press enter to enter the video quality set up page.

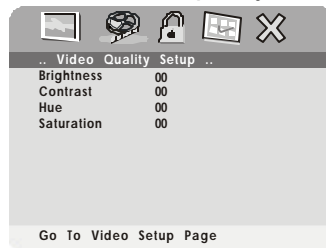

Figure 10. Main SETUP Menu VIDEO QUALITY

a).Select “Brightness by using the Up/Down buttons,then press “Enter”. Adjust can change the Brightness by pressing the left/right arrow buttons. When complete, press “Enter” again to return to the “Video Quality” set up page.



Figure 11. BRIGHTNESS Screen Display

- b). Select "Contrast" using the Up/Down buttons, then press "Enter". You can adjust the Contrast using the left/right buttons.

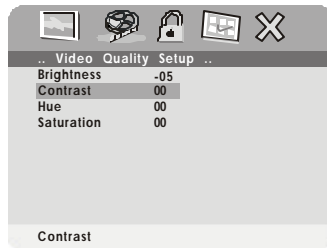

Figure 12. CONTRAST Screen Display

When complete, press "Enter" again return to the "Video Quality" setup page.

- c). Select "Hue" using the Up/Down buttons, then press Enter". You can adjust the Hue using the left/right buttons.

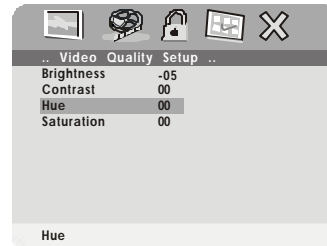

Figure 13. HUE Screen Display

When complete press "Enter" again to return to the "Video Quality" setup page.

- d). Select "Saturation" using the Up/Down buttons, then press "Enter". You can adjust the Saturation by using the left/right buttons.

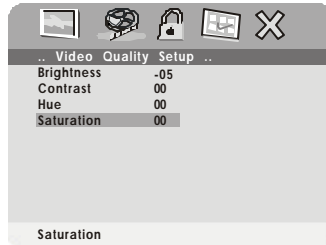

Figure 14. SATURATION Screen Display

When complete, press “Enter” again to return to the “Video Quality” setup page.

- e) Press Setup button to exit “Video Quality” setup page.
- 3). With no disc in the player, select “password” using the left/right buttons; then press Enter to enter the “Change Password” page.

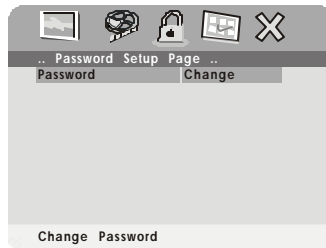

Figure 15. PASSWORD CHANGE Screen Display

- a) Press the right shift button to enter the Password Change Submenu. Input the Old Password or the Default Password, the New Password, and the Confirmed New Password. Press ‘ENTER’ to confirm the change.
- b) Press Setup button to exit “Video Quality” setup page.

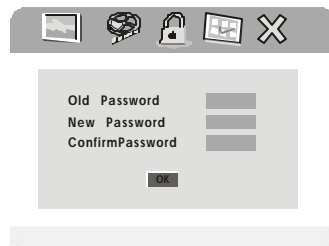

Figure 16. PREFERENCE PAGE Screen Display

NOTE: The Default Password is **3308**. This password is always effective even after you have selected your own password and changed it. To avoid the possibility of others using the default password to set the parental level and change the password, you can record this default password in another area and delete it from this manual. Some discs can be limited depending on the age of users while some discs can not.

4). With no disc in the player, select 'PREFERENCES' using the left/right buttons; then press 'ENTER' to enter the preferences page.

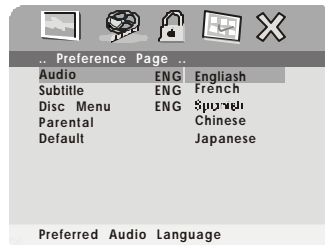

Figure 17. AUDIO Preference Screen Display

- Select 'AUDIO' using UP/DOWN, then press 'RIGHT' to enter the submenu. Select the audio language you desire using UP/DOWN, then press 'ENTER' to confirm the setting. Then press LEFT to return.
- Select 'SUBTITLE' using UP/DOWN, then press RIGHT to enter the submenu. Select the desired subtitle language or SUBTITLE OFF using UP/DOWN, then press 'ENTER' to confirm the setting. Press 'LEFT' to return.

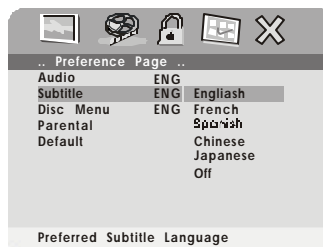

Figure 18. SUBTITLE Preference Screen Display

- c. Select 'DISC MENU' using UP/DOWN, then press 'RIGHT' to enter the submenu. Select the Disc Menu Language you desire using UP/DOWN, then press 'ENTER' to confirm the setting. Press 'LEFT' to return.



Figure 19. DISC MENU Preference Screen Display

Note: Language and subtitle selection is only available for discs that are recorded in the above listed languages. If the selected, language is not available, the player will play and display on the screen the original recorded language contained in the disc.

- d. Select 'PARENTAL' using UP/DOWN, then press RIGHT to enter the submenu.

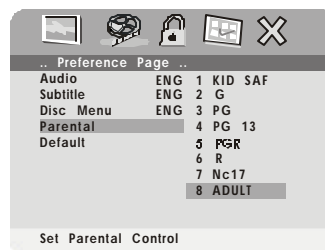

Figure 20. PARENTAL Preference Screen Display

Select the parental level you desire using UP/DOWN for discs with lock-out function or multiple rating levels. These are listed from the lowest level (1 Child) to the highest level (OFF).

NOTE: Level 8 (Adult) is the default.

- e. Select 'DEFAULTS' using UP/DOWN, then press RIGHT to enter the submenu. Press ENTER to make the setting return to the factory-set mode.

NOTE: The parental setting is not affected by the default function.

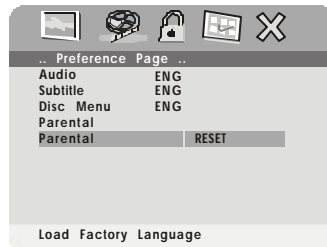

Figure 21. DEFAULT RESET Screen Display

Enter a 4 digit password, then press 'ENTER' to confirm the parental level setting.

NOTE: For 1st time use the default password is 3308.

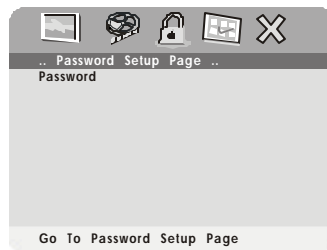

Figure 22. PASSWORD VERIFY Input Screen Display

1. Basic Operation

POWER	Turn the unit on/off
OPEN	Remove/load the disc
PLAY	Start Play/Execute item or setting
SLOW	Play at 1/2, 1/4, 1/8 or 1/16 times speed
PAUSE	Still Picture
STOP	(1 time) Stop at the present playing point / (2 times) Stop playing
NEXT	Go to the next chapter, track or scene during play back
PREVIOUS	Go back to the preceding chapter, track or scene during play back
FORWARD	Scan forward at 2, 4, 8, 16 or 32x times speed
REVERSE	Scan backward at 2, 4, 8, 16 or 32x times speed
UP/DOWN/LEFT /RIGHT	Used for Menu Navigation
ENTER	Execute item or setting
NUMBERS	Select item or setting
RETURN	Return
MENU	Display the root menu of the disc
REPEAT	Repeat playing title, chapter, or track
A-B	Repeat a specific portion from point A to point B of the disc
DISPLAY	Display information (title, chapter, track, time, etc.).
ANGLE	Change the angles on the scene
SUBTITLE	Select the subtitle language and turn it on/off
AUDIO	Select the audio language
ZOOM	Enlarge an image to 2, 3, or 4 times the original
SETUP	Display the setup menu to select and set items, and exit the setup menu.

2. MENU

A DVD is divided into sections called titles and chapters. When you play a DVD, a root menu of the disc will appear on the screen of your TV or Monitor. The contents of the menu vary from disc to disc. Press MENU during playback to display the menu, and press ENTER or PLAY to start playing. Some DVDs only allow you to select disc playback options using the DVD menu.

3. DISPLAY *(Display contents vary from disc to disc.)*

1) PLAYING TIME AND REMAINING TIME

- a. During playback press 'DISPLAY' to display the current Title Number (1), the total Number of Titles (2), the current Chapter Number (3), the total Number of Chapters (4), and the Playing Time for the title (5). The heading will disappear automatically after 3 seconds if no buttons are pressed.

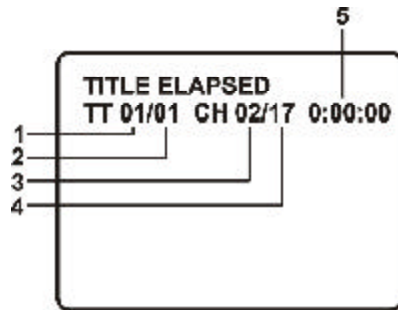

Figure 23. Title, Chapter Number, and Time Screen Display

- b. Press 'DISPLAY' again to display the Remaining Time of the title. The heading will disappear automatically in about 3 seconds.

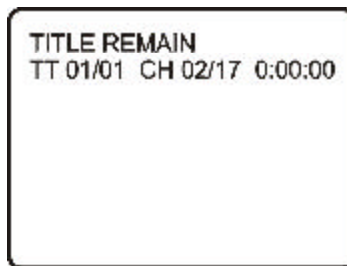

Figure 24. Title Remaining Time Screen Display

- c. Press 'DISPLAY' the 3rd time to display the Elapsed Time for the chapter. The heading will disappear automatically in about 3 seconds.

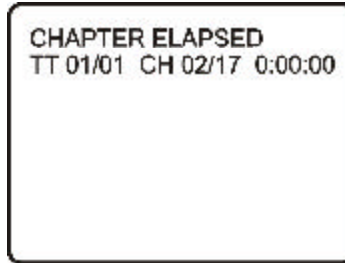

Figure 25. Chapter Elapsed Time Screen Display

- d. Press 'DISPLAY' the 4th time to display the Remaining Time for the chapter. The heading will disappear automatically after 3 seconds.

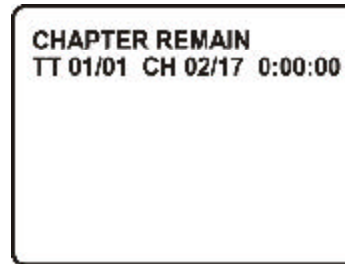

Figure 26. Chapter Remaining Time Screen Display

- e. Press 'DISPLAY' a 5th time to exit. 'DISPLAY OFF' will be displayed and will disappear automatically after 3 seconds.

2) ANGLE

During playback of a disc, press 'ANGLE' to display the available angles for discs containing multi-angles*, with the current angle number (1) and the total number of angles (2) displaying. Press 'ANGLE' to select another angle, then press again to exit and return to the normal viewing angle. The angle display will disappear automatically if the 'ANGLE' button is not pressed again within 3 seconds.

***NOTE:** Not all discs contain this feature

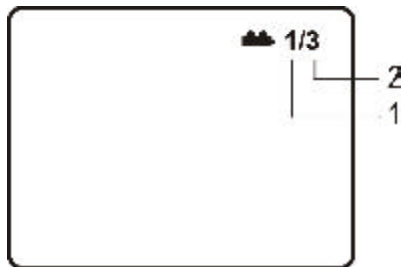

Figure 27. Angle Screen Display

3) SUBTITLE

During disc playback press 'SUBTITLE' to select the subtitle language you desire*, with the current Subtitle Language Number (1) and the total Number of Subtitle Languages (2) displayed. If there are multiple languages press 'SUBTITLE' again to select another subtitle language. To turn subtitles OFF, press the 'SUBTITLE' button until 'SUBTITLE OFF' is displayed. The Subtitle display will disappear automatically if the 'SUBTITLE' button is not pressed again within 3 seconds.

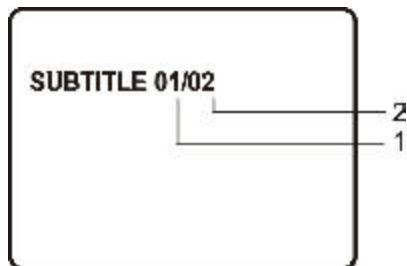

Figure 28. Subtitle Screen Display

*Some DVDs only allow access to this function through the DVD menu.

4) AUDIO

During playback press 'AUDIO' to select the audio language you desire*, with the current Audio Channel Number (1) and the total number of Audio Channels (2) displayed. Press AUDIO again to select another audio language. The audio display will disappear automatically if the 'AUDIO' button is not pressed again for 3 seconds.

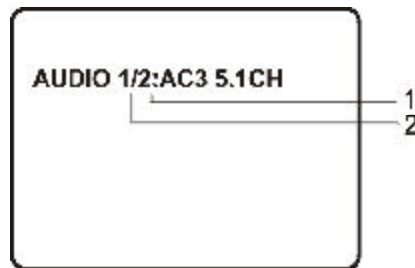

Figure 29 Audio Language Screen Display

* Some DVDs only allow access to this function through the DVD menu.

5) ZOOM

During playback press 'ZOOM' to enlarge the picture by 2x, 3x or 4X with the current zoom multiple. (1) Press "zoom" once; the picture will be enlarged 2X. (2) Press "zoom" a second time; the picture will be enlarged 3X. (3) Press "zoom" a 3rd time; the picture will be enlarged 4X. (4) Press "zoom" a 4th time, the picture will return to normal.

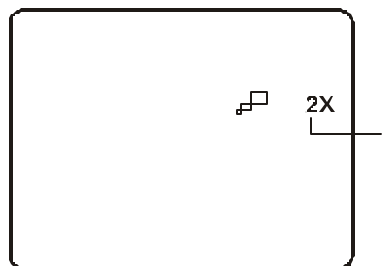

Figure 30. ZOOM Screen Display

- 6) A-B REPEAT
- a. During playback press 'A-B' to set the Starting Point A.



Figure 31. A-B Repeat Starting Point Screen Display

- b. Press 'A-B' a second time to set the Ending Point B and the player will repeatedly play the part between Point A and Point B

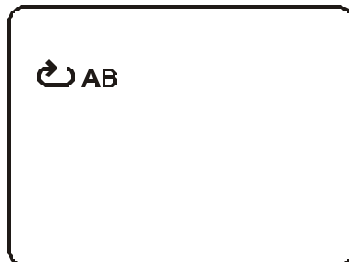

Figure 32. A-B Repeat Ending Point Screen Display

- c) Press A-B a third time to cancel A-B repeat and resume playback from point A.

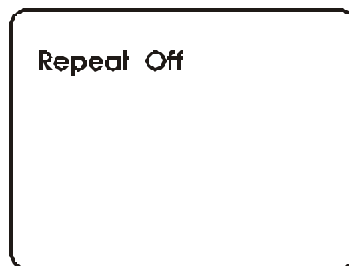

Figure 33. A-B Repeat Cancelled Screen Display

7) REPEAT

- a. During playback press 'REPEAT' once to repeatedly play the current chapter.

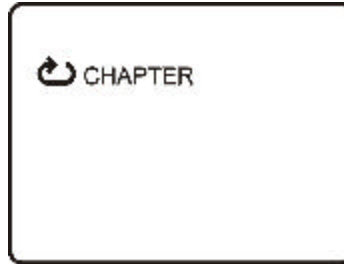

Figure 34. Chapter Repeat ON Screen Display

- b. During playback press 'REPEAT' a second time to repeatedly play the current title.



Figure 35. Title Repeat ON Screen Display

- c. During playback press 'REPEAT' a 3rd time to repeat all Chapters and Titles. The 'REPEAT ALL' screen will disappear automatically if the 'REPEAT' button is not pressed again for 3 seconds.



Figure 36. Title Repeat ON Screen Display

- d. Press "REPEAT" a fourth time to resume normal playback.



Figure 37. Repeat Off Screen Display

4. PLAYING AUDIO CDS

When playing an audio CD. Press the DISPLAY button on the remote to display the DISPLAY Banner. The options below show you what happens when you press the DISPLAY button.

- a. During playback press 'DISPLAY' once and *SINGLE ELAPSED* will appear along with the current track playing and the time of that track.

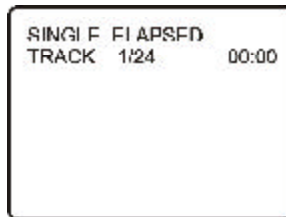

Figure 38. SINGLE ELAPSED Screen Display

- b. Press 'DISPLAY' a second time and *SINGLE REMAIN* appears along with the current track playing the amount of time left on the track.

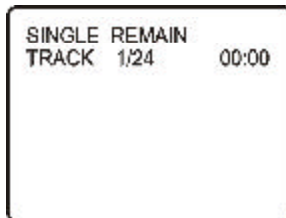

Figure 39. SINGLE REMAIN Screen Display

- c. Press 'DISPLAY' a third time and *TOTAL ELAPSED* appears along with the current track playing and the total time that the CD has been playing.

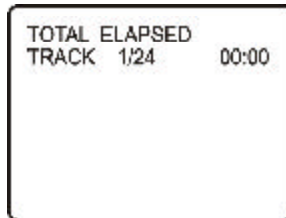

Figure 40. TOTAL ELAPSED Screen Display

- d. Press 'DISPLAY' a fourth time and *TOTAL REMAIN* appears along with the current track playing and the amount of time remaining on the CD.

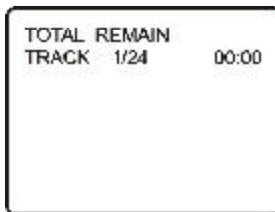

Figure 41. TOTAL REMAIN Screen Display

- e. Press 'DISPLAY' a fifth time and "*DISPLAY OFF*" will appear momentarily then disappear. The CD time information will not be displayed.

1) USING THE REPEAT FEATURE

The default mode for the Repeat feature is OFF. Pressing REPEAT consecutively changes the repeat options:

- *TRACK*- repeats the track that is playing.
- *ALL*- repeats the disc that is playing.
- *OFF*

As you toggle through the options, the repeat option changes. The selected repeat option loops repeatedly until you turn it off.

5. PLAYING MP3 DISCS

MP3 is a format for storing digital audio. An audio CD-quality song is compressed into the MP3 format with very little loss of audio quality while taking up much less disc space. CD-R/RW discs that have been encoded in MP3 format are compatible with this system.

Playback modes:

FOLDER (normal playback)

SINGLE

REPEAT ONE (repeat playback of a song)

REPEAT FOLDER (repeat playback of a specific folder)

1. Insert an MP3 CD, the DVD video player will initialize the disc and the directory will be shown on the monitor.

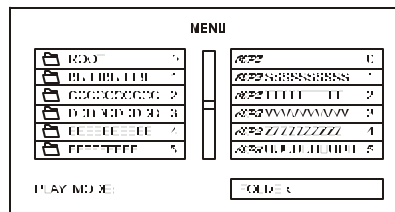

Figure 42. MENU Screen Display

When an MP3 disc is inserted into the unit, the menu screen appears automatically. You can use the menu screen to change folders and songs. The system plays the songs in the order they were burned onto the disc.

1. Press the ▲ or ▼ button to choose a folder from the folder list on the left side of the screen.
2. Press ENTER to select the highlighted folder. The songs available in that folder will be listed on the right side of the screen.
3. Press the Right (▶) button to enter the track list.
4. Press the ▲ or ▼ button to choose a song from the list. Press ENTER to select and begin playback of the highlighted song.

SKIPPING SONGS

Use the ►► (NEXT) button to move to the next song. Press the ◀◀ (PREVIOUS) button to move to the beginning of the previous song.

USING THE REPEAT FEATURE

The default mode for the Repeat feature is OFF. Pressing REPEAT consecutively changes the repeat options:

- FOLDER
- SINGLE
- REPEAT ONE
- REPEAT FOLDER

Press REPEAT a 3rd time to resume normal playback. As you toggle through the options, the repeat option changes. The selected repeat option loops repeatedly until you turn it off.

NOTICE

- The upper left column is a list showing the name of folder. The upper right column is a list showing the name of song and the sub-folder.
- “” sign in front of a file name indicates that this is a folder, not an MP3 file.
- “MP3” sign in front of a file name indicates that this is a MP3 file. During MP3 playback, you cannot access “PLAY MODE”, folders or songs.
- You are allowed a maximum of 11 characters for each folder or/and songs.

6. Playing JPG file

- 1). Load the JPG Disc into tray
- 2). Select the JPG file by pressing the “ Up/Down” buttons.
- 3). You can preview the JPG file by pressing “Play” or “OK”.
- 4). Press the left or right buttons to rotate the image in 90-degree steps.
- 5). Press the up or down buttons to rotate the image 180 degrees.
- 6). While you preview the JPG file, press “display”; there are different refresh modes available.

- | | |
|-----------------------------------|--------------------------|
| 6.1) WIPE TOP | refresh from top side |
| 6.2) WIPE BOTTOM | refresh from bottom side |
| 6.3) WIPE LEFT | refresh from left side |
| 6.4) WIPE RIGHT | refresh from right side |
| 6.5) DIAGONAL WIPE
LEFT TOP | refresh from left top |
| 6.6) DIAGONAL WIPE
RIGHT TOP | refresh from right top |
| 6.7) DIAGONAL WIPE
LEFT BOTTOM | refresh from left bottom |

- 6.8) DIAGONAL WIPE refresh from right bottom
RIGHT BOTTOM
- 6.9) EXTEND FROM CENTER H refresh from center
horizontally to both sides
- 6.10) EXTEND FROM CENTER V refresh from center
vertically to both sides
- 6.11) COMPRESS TO CENTER H refresh compress from
center horizontally
- 6.12) COMPRESS TO CENTER V refresh compress from
center vertically
- 6.13) WINDOW H refresh from four window's left
- 6.14) WINDOW V refresh from four window's right
- 6.15) WIPE FROM EDGE TO CENTER refresh from edge to center

- 7. When previewing the file, pressing "ANGLE, SUBTITLE, AUDIO, NUMBER, AB, RETURN, REW/FF, or SLOW" causes a hand icon (invalid function) to appear on the display.
- 8. When pressing the first time during preview, "SLIDE SHOW MENU" will display on the screen.
- 9. Then press "PLAY" or "OK", the left top photo will be previewed.
- 10. You can return to the root Menu by pressing the Menu button.

7. Playing a Video Game (Refer to Figure 38)

- 1. Slide the AV in/out switch to the "In" position.
- 2. Plug the video output from your game system into the supplied A/V adapter cable and plug the adapter cable into the Audio (black) and video (yellow) jacks on the left side of the unit. Adjust the volume

control and the brightness control on the monitor for individual preference.

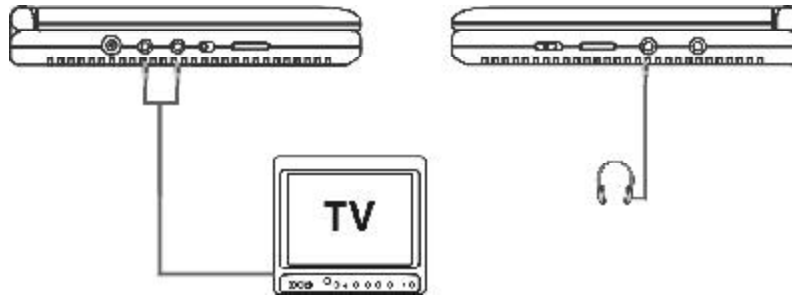

Figure 43

8. Connecting to a TV or another monitor (Refer to Figure 38)

You can also connect the DVD player to a TV to enjoy high quality stereo sound or another monitor.

1. Slide the AV in/out switch to the “out” position.
2. Connect one end of the audio/video cable’s black (1/8” stereo plug) plug into the unit’s DVD AUDIO OUT jack, and connect the other end to the AUDIO INPUT jacks on your TV or Monitor (white = left channel, red = right channel).
3. Connect the audio/video cable’s yellow plug into the VIDEO OUT jack on the side of the unit, and the other yellow plug to the VIDEO INPUT jack on your TV or Monitor.

9. Connecting Coaxial Output

The coaxial output of the unit can be used with an optional cable that has a stereo 1/8 inch male connector and a male RCA connector. The output of cable can be applied to any device which accepts a digital coaxial signal.

10. Specifications

Disc format: DVD/CD/MP3

Color system: NTSC

Screen size: 7.0"

DVD video format: Horizontal 720 pixel, vertical 480 pixel (NTSC)

Frequency response: DVD (PCM 96 kHz/24 bits): 20 Hz to 44 kHz

DVD (PCM 48 kHz): 20 Hz to 22 kHz

CD: 20 Hz to 20 kHz

Video output: 1.0 Vp-p/75 Ohm, unbalanced

Video S/N: Better than 35 dB

Audio output: 2 x 0.4 W

Audio S/N: Better than 35 dB

Power source: DC 9V

Power consumption: 14 W

Operating temperature: 5~40°C (41~104°F)

Storage temperature: -20~60°C (4~140°F)

Operating humidity: 10~75%

Dimensions (W x H x D):8.07 X 5.92 X1.98inches

205 x 150.5 x 35.5mm

Battery Type: Lithium Ion (Li-ION)

11. Rechargeable Battery Installation and Use

The player utilizes a set of long-life NiMH batteries for portable power supply. The Li-ION battery pack is specially designed for your player, please consult your dealer for purchasing the battery pack. Li-ION batteries feature high storage capacity and low level of degradation. This means the Li-ION batteries doesn't have "Memory Effect" and thus can be recharged safely regardless of whether the battery is fully or only partially spent. Please fully charge the battery prior to first use.

NOTE: When the DVD player is used with the battery as a power source, ensure that the battery has been charged for at least eight hours prior to connecting it to the DVD player.

If you plan to not use the battery for an extended period of time (say, one week or longer), we recommend that you first fully charge the battery and store it away properly. For longer periods of storage, please recharge the battery at least once every two months to maintain the battery in its best condition. Please under no circumstances short out the battery, store the battery in a metal container, or leave the battery in a humid or damp environment. Ideally, store the battery in an airtight container with desiccant or other dehumidifying agent. Each full recharge takes approximately five-hours and one full charge can provide power the player for approximately 3 hours.

During recharge, the light next to the DC power input will light up red. Once fully recharged, the light will turn green. At this point you may remove the wall plug and cease charging.

Precautions related to Battery Recharge:

1. Once the battery has been fully spent, please immediately recharge the battery (regardless of whether you plan to use battery power again soon) in order to maximize battery life.
2. To charge the battery, please connect the power jack directly into the LMD-3708 and leave the POWER switch in the off position.

Using and Maintaining your Rechargeable Batteries

1. Please make sure you always use only the AC transformer included with the player to recharge your batteries.
2. Recharge effectiveness will degrade when environmental temperatures drop below 50°F (10°C) or exceed 95°F (35°C).
3. Please remove battery from the player and store properly if the player is not to be used for an extended period of time. For periods of two months or more, please recharge the battery at least once every two months to avoid irreparable damage to the battery. If the battery

left attached to the player for an extended period, please recharge the battery at least once every two weeks.

4. Avoid unnecessarily recharging fully charged batteries.

Installing the Battery Pack:

1. First, make sure the player is in “Stop” mode and that the AC power supply has been disconnected.
2. Close the player cover.
3. Align the battery pack with the player module’s front edge.
4. Push the battery towards the rear of the player until it locks into position. The lock position is indicated by a click. The unit will fit snugly to the player.

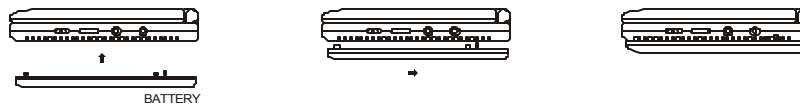

Figure 44. Installing the DVD Player Battery

Removing the Battery Pack:

1. First, make sure the player is in “Stop” mode and that the AC power supply has been disconnected.
2. Press the release button in the down direction.
3. Slide the battery towards the front of the unit.

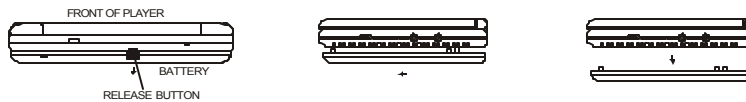

Figure 45. Removing the DVD Player Battery



90 DAY LIMITED WARRANTY

Applies to Audiovox Video Products

AUDIOVOX ELECTRONICS CORP. (the Company) warrants to the original retail purchaser of this product that should this product or any part thereof, under normal use and conditions, be proven defective in material or workmanship within 90 days from the date of original purchase, such defect(s) will be repaired or replaced with reconditioned product (at the Company's option) without charge for parts and repair labor.

To obtain repair or replacement within the terms of this Warranty, the product is to be delivered with proof of warranty coverage (e.g. dated bill of sale), specification of defect(s), transportation prepaid, to the Company at the address shown below.

This Warranty does not extend to the elimination of externally generated static or noise, to correction of antenna problems, to costs incurred for installation, removal or reinstallation of the product, or to damage to tapes, discs, speakers, accessories, or electrical systems.

This Warranty does not apply to any product or part thereof which, in the opinion of the Company, has suffered or been damaged through alteration, improper installation, mishandling, misuse, neglect, accident, or by removal or defacement of the factory serial number/bar code label(s). THE EXTENT OF THE COMPANY'S LIABILITY UNDER THIS WARRANTY IS LIMITED TO THE REPAIR OR REPLACEMENT PROVIDED ABOVE AND, IN NO EVENT, SHALL THE COMPANY'S LIABILITY EXCEED THE PURCHASE PRICE PAID BY PURCHASER FOR THE PRODUCT.

This Warranty is in lieu of all other express warranties or liabilities. ANY IMPLIED WARRANTIES, INCLUDING ANY IMPLIED WARRANTY OF MERCHANTABILITY, SHALL BE LIMITED TO THE DURATION OF THIS WRITTEN WARRANTY. ANY ACTION FOR BREACH OF ANY WARRANTY HEREUNDER INCLUDING ANY IMPLIED WARRANTY OF MERCHANTABILITY MUST BE BROUGHT WITHIN A PERIOD OF 30 MONTHS FROM DATE OF ORIGINAL PURCHASE. IN NO CASE SHALL THE COMPANY BE LIABLE FOR ANY CONSEQUENTIAL OR INCIDENTAL DAMAGES FOR BREACH OF THIS OR ANY OTHER WARRANTY, EXPRESS OR IMPLIED, WHATSOEVER. No person or representative is authorized to assume for the Company any liability other than expressed herein in connection with the sale of this product.

Some states do not allow limitations on how long an implied warranty lasts or the exclusion or limitation of incidental or consequential damage so the above limitations or exclusions may not apply to you. This Warranty gives you specific legal rights and you may also have other rights which vary from state to state.

U.S.A. : AUDIOVOX ELECTRONICS CORPORATION, 150 MARCUS BLVD.,
HAUPPAUGE, NEW YORK 11788 • 1-800-645-4994

CANADA : CALL 1-800-645-4994 FOR LOCATION OF WARRANTY STATION
SERVING YOUR AREA

128-5556C

Free Manuals Download Website

<http://myh66.com>

<http://usermanuals.us>

<http://www.somanuals.com>

<http://www.4manuals.cc>

<http://www.manual-lib.com>

<http://www.404manual.com>

<http://www.luxmanual.com>

<http://aubethermostatmanual.com>

Golf course search by state

<http://golfingnear.com>

Email search by domain

<http://emailbydomain.com>

Auto manuals search

<http://auto.somanuals.com>

TV manuals search

<http://tv.somanuals.com>