

BELKIN®

# OmniView™

## E Series User Manual



F1DB102P  
F1DB104P  
F1DB102P-B

## Table of Contents

Overview	2
Feature Overview	2
Equipment Requirements	3
Operating System	4
Unit Display Diagrams	5
Specifications	7
Installation	8
Pre-Configuration	8
Step-by-Step Installation Guide	9
Powering up the Systems	11
Using your E Series KVM Switch	11
Selecting a Computer Using Front-Panel Selector Buttons	11
Selecting a Computer Using Keyboard Hot Key Commands	12
AutoScan Mode	13
Belkin KVM Switches and Accessories	14
OmniView KVM Switches	14
OmniView KVM Cables	16
OmniView Accessories and Adapters	17
FAQ E Series	18
Troubleshooting	21

## Introduction

Congratulations on your purchase of a Belkin OmniView KVM switch. Our diverse line of quality KVM solutions exemplifies the Belkin commitment to delivering quality and durability at an affordable price. Engineered to give you control over multiple computers/servers from one console, Belkin KVM switches come in a variety of capacities suitable for all configurations, large or small. This compact, affordable Belkin OmniView KVM switch is backed by a Belkin Two-Year Warranty and free technical support.

This manual will provide details about your new OmniView E Series KVM Switch, from installation and operation, to troubleshooting—in the unlikely event of a problem.

For easy installation, please refer to the Quick Installation Guide included with your switch.

Thank you for purchasing the Belkin OmniView E Series KVM Switch. We appreciate your business and have confidence that you will soon see for yourself why over 1 million Belkin OmniView products are being used in server rooms and test labs worldwide.

### Contents of Package:

- OmniView E Series KVM Switch
- User's Manual
- Quick Installation Guide
- 2 KVM Cable Kits (F1DB102P-B Only)

## OVERVIEW

### OVERVIEW

The Belkin OmniView E Series KVM Switch allows you to control up to four computers, depending on the model, with one keyboard, monitor, and mouse. OmniView E Series KVM Switches support PS/2 input devices (keyboard and mouse); VGA, SVGA, XGA, and XGA-II video; and PS/2 output computers. With the use of an OmniView PS/2 MAC Adapter or OmniView PS/2 SUN Adapter, the OmniView E Series can also be used to control Mac and Sun® computers.

### Feature Overview

#### Hot Keys:

Hot keys allow you to select ports using designated key commands. Control up to four computers, depending on the model, using a simple hot key sequence on your keyboard. Full hot key instructions for usage and commands are located in this manual, on page 12.

#### AutoScan:

The AutoScan feature allows you to automatically scan and monitor the activities of all operating computers connected to your OmniView E Series KVM Switch one by one. Usage instructions for AutoScan are located in this manual, on page 13.

#### Video Resolution:

With a 400MHz video bandwidth, the OmniView E Series KVM Switch is able to support video resolutions of up to 2048x1536@85Hz. To preserve signal integrity at high resolutions, 75-Ohm coaxial VGA cabling is required.

#### Front-Panel Push Button:

Push buttons conveniently located on the face of the OmniView E Series KVM Switch allow for simple, manual port selection.

#### LED Display:

LEDs are added to the front of the OmniView E Series KVM Switch for easy status monitoring. A lit LED indicates which computer the console has control of. When using the front-panel push button, the LED will light next to the corresponding active port.

## OVERVIEW

### Equipment Requirements

#### Cables:

For each PS/2 computer to be connected to the OmniView E Series KVM Switch, one VGA cable, one PS/2 keyboard cable, and one PS/2 mouse cable is necessary. Keyboard and mouse cables must have PS/2 male to PS/2 male connectors.

To support resolutions of up to 2048x1536@85Hz, use of a 75-Ohm coaxial VGA cable is required to preserve signal integrity. Cables must have HDDB15 female to HDDB15 male connectors.

The Belkin OmniView All-In-One Cable Kits offer the highest quality possible to ensure that your data is optimally transmitted. All-In-One Cable Kits are molded together for clean and organized setup, and include PC99 color for easier identification and connection. Double-shielded, strain-relief, ferrite-bead, PRO Series Plus cable kits include an industry-standard, 14-pin coaxial VGA cable and nickel-plated connectors for high-resolution applications. The Gold Series Cable Kits have a custom 15-pin coaxial VGA cable and gold-plated connectors for superior clarity and connectivity for maximum resolution. The following cable kits are recommended for your OmniView E Series KVM Switch:

#### F3X1105-XX (PS/2 Style)

#### F3X1835-XX-GLD (PS/2 Style)

(-XX designates the length in feet)



## OVERVIEW

### Operating Systems

OmniView E Series KVM Switches are for use on PS/2-based computers.

#### Platforms:

- Windows® 3.x/95/98/2000/Me/NT®/XP
- DOS
- Linux®
- Novell® NetWare® 4.x/5.x

#### Keyboards:

- Supports 101-102-104-key keyboards

#### Mice:

- Microsoft® compatible PS/2 mice with 2, 3, 4, or 5 buttons
- Microsoft compatible DB9 serial mice (with use of adapter)

#### Monitor:

- VGA
- SVGA
- MultiSync®

#### Optional Power Supply:

An optional 9V 600mA power supply is available. Visit [belkin.com](http://belkin.com) for ordering information.

## OVERVIEW

### Unit Display Diagrams with Explanation

The Front of the OmniView E Series KVM Switch:

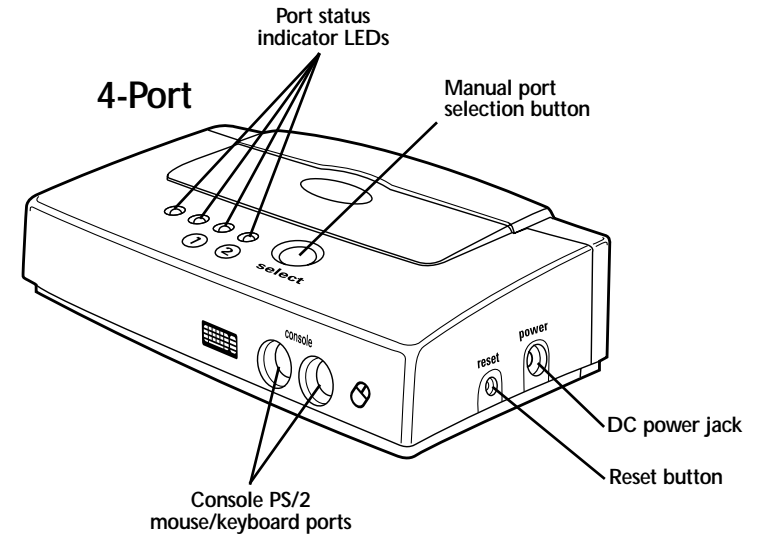

### 2-Port

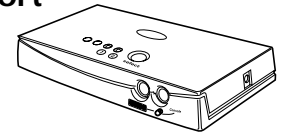

## OVERVIEW

The Rear of the OmniView E Series KVM Switch:

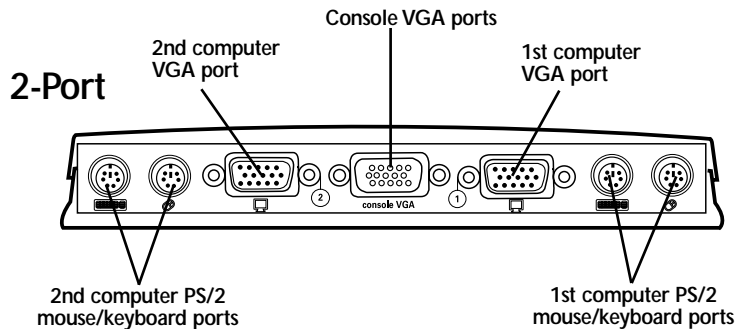
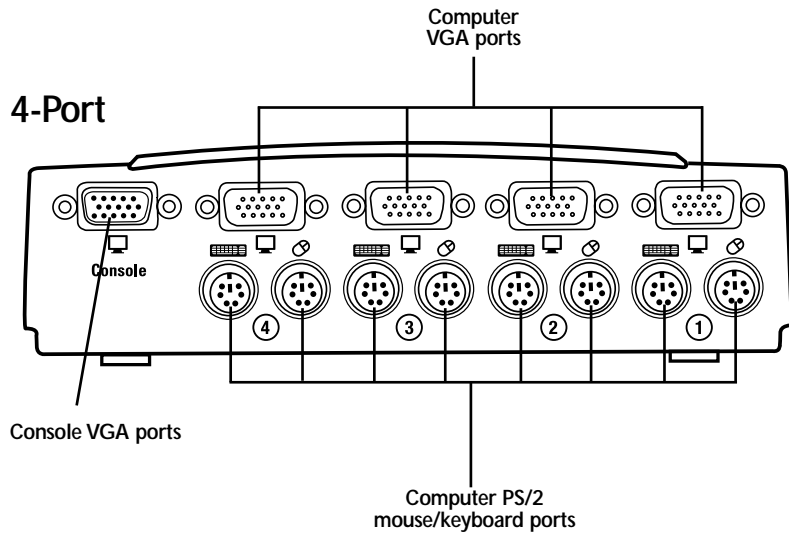

## OVERVIEW

### Specifications

**Part No.:** F1DB102P, F1DB104P

**Power:** By PS/2 keyboard port or optional 9V DC, 600mA AC adapter with center pin positive polarity

**PCs Supported:** 2 (F1DB102P), 4 (F1DB104P)

**Keyboard Emulation:** PS/2

**Mouse Emulation:** PS/2

**Monitor Supported:** VGA and SVGA MultiSync, LCD (with use of adapter cable)

**Max Resolution:** 2048X1536@85Hz

**Keyboard Input:** 6-pin miniDIN (PS/2)

**Mouse Input:** 6-pin miniDIN (PS/2)

**VGA Port:** 15-pin HDBD-type

**LED Indicators:** 2 (F1DS102P), 4 (F1DS104P)

**Enclosure:** Plastic

**Dimensions:**

F1DS102P

(H)1.125 x (W)7.0 x (D)3.75 inches/(H)2.9 x (W)17.8 x (D)9.6 centimeters

F1DS104P

(H)2.0 x (W)7.0 x (D)3.75 inches/(H)5.1 x (W)17.8 x (D)9.6 centimeters

**Weight:**

F1DS102P 9 oz. (0.26kg.)

F1DS104P 12 oz. (0.34kg.)

**Operating Temp:** 32° to 104° F (0° to 40° C)

**Storage Temp:** -4° to 140° F (-20° to 60° C)

**Humidity:** 0-80% RH, non-condensing

**Warranty:** 2 years

**Note:** Specifications are subject to change without notice

## INSTALLATION

### Pre-Configuration

#### Where to Place the KVM Switch:

The OmniView E Series KVM Switch is designed to sit on the desktop. Where you place the KVM Switch will be based on the location of your CPUs and the length of your cables.

#### Cable Distance Requirements:

For PS/2 computers: VGA signals are best retained when transmitted up to 25 feet (7.5m). Beyond 25 feet (7.5m), probability of video degradation increases with an increase in distance. For this reason, your PS/2 computer should be placed within 25 feet (7.5m) of the KVM Switch.

**Note:** If your computer needs to be more than 25 feet (7.5m) from the KVM switch, you can use the Belkin CAT5 Extender to extend your PS/2 keyboard, PS/2 mouse, and monitor up to 500 feet (152.4m) away using standard CAT5 UTP cable.

#### Cautions and Warnings:

Avoid having cables near fluorescent lights, air conditioning equipment, or machines that create electrical noise (e.g., vacuum cleaners).

π

## INSTALLATION

### Step-by-Step Installation Guide

This section provides complete instructions for the hardware setup of a single E Series KVM Switch. (F1DB102P or F1DB104P)

#### Important Note:



Before attempting to connect anything to the E Series KVM Switch or to any computer, make sure that everything is powered off. Plugging and unplugging cables while computers are powered on can cause irreversible damage to your computers and/or KVM switch. Belkin Components will not be responsible for damage caused by these actions.

#### Keyboard, Video, and Mouse Connections for E Series KVM F1DB102P, F1DB104P

#### CONNECT THE CONSOLE:

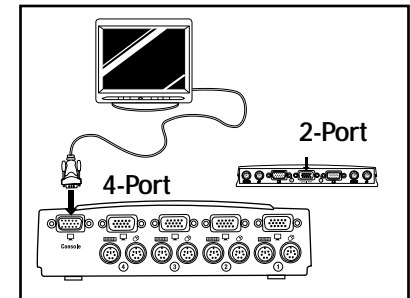
1.  Connect the monitor to the E Series KVM Switch. Using the cable that is included with your monitor, connect it to the HDB15 female port on the top of the E Series KVM Switch with the monitor symbol on the console.



2.  Connect a PS/2 keyboard to the PURPLE port on the CONSOLE.
3.  Connect a PS/2-type mouse to the GREEN port on the CONSOLE.

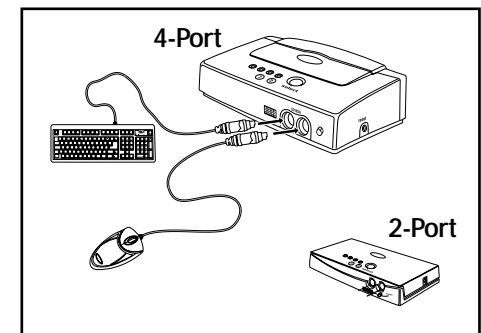



## INSTALLATION

### CONNECT THE COMPUTER:

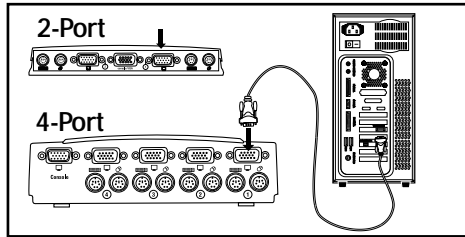
4.  Connect the first computer's VGA cable to the E Series KVM Switch. Using the VGA cable (Belkin Part# F3X1105-XX, F3X1835-XX, or F2N209-XX), connect the male end of the cable to the VGA port on the computer, and the female end to the VGA port on the rear of the E Series KVM Switch labeled CPU1.



5.   Connect the first computer's PS/2 keyboard and PS/2 mouse cable to the appropriate ports on the section labeled CPU1. (Belkin Part# F3X1105-XX, F3X1835-XX, or F2N036-XX).

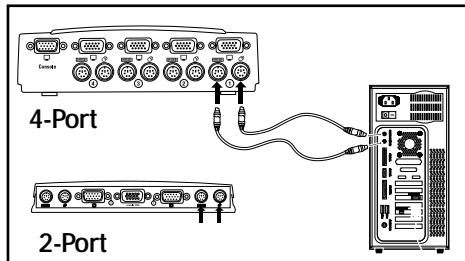

6. Repeat steps 4 and 5 for each additional computer you wish to connect.

## USING YOUR E SERIES KVM SWITCH

### Powering up the Systems

Once all cables have been connected, power up the CPUs that are attached to the E Series KVM Switch. All computers can be powered on simultaneously. The E Series KVM Switch emulates a mouse and keyboard on each port and allows your computer to boot normally. Your Belkin E Series KVM Switch should now be ready for use.

You can select which computer to operate by either the push-button Selector Button located on the top panel of the E Series KVM Switch or through keyboard hot key commands. Note that it will take 1 to 2 seconds for the video to display after switching. This is due to the refresh of the video signal. There is also resynchronization of the mouse and keyboard signal that takes place. This is normal operation and ensures that proper synchronization is established.

### Selecting a Computer Using Front-Panel Selector Buttons

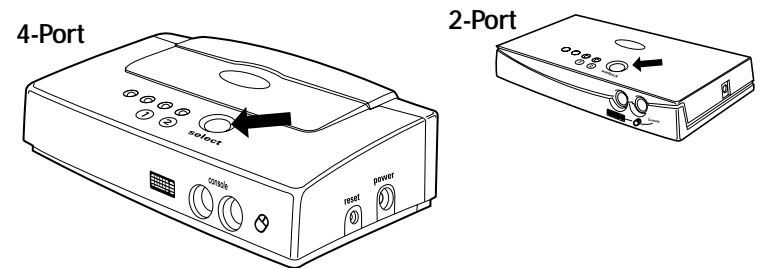

You can directly select a connected computer by pressing the Selector Button on the switch. The LED will be lit above the number to indicate which port is currently selected.

## USING YOUR E SERIES KVM SWITCH

### Selecting a Computer Using Keyboard Hot Key Commands

You can conveniently change ports with the switch through a keyboard command sequence by using the [SCROLL LOCK] key and [UP], [DOWN] arrow keys. To send commands to the E Series KVM Switch, press the [SCROLL LOCK] key twice within two seconds. You will hear a beep for confirmation. Then you can press the [UP], [DOWN] arrow keys to switch between ports.

You can switch directly to any port by entering the E Series KVM Switch port number you wish to use. For example, if you press [SCROLL LOCK], [SCROLL LOCK], [2], the computer on port 2 will be selected.

#### [SCROLL LOCK], [SCROLL LOCK]

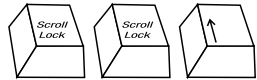

Switch to next active port, [UP] arrow

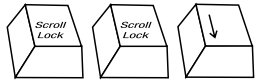

Switch to previous active port, [DOWN] arrow

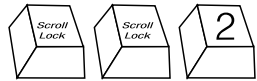

Switch to Port 2 [2], #2 key

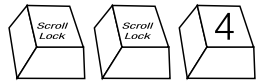

Switch to Port 4 [4], #4 key

## USING YOUR E SERIES KVM SWITCH

### AutoScan Mode

In AutoScan mode, the E Series KVM Switch remains on one port for 10 seconds before switching to the next. This time interval cannot be changed.

To enable AutoScan mode press [SCROLL LOCK], [SCROLL LOCK], [0], [0]

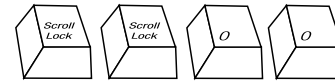

**Note:** There is no mouse or keyboard control in this mode. This is necessary to prevent errors. Otherwise, if the user is moving the mouse or using the keyboard when the KVM switches to the next port, communication between the computer and KVM could be interrupted and cause erratic mouse movement, or wrong characters to display when using the keyboard.

To disable AutoScan mode, press the space bar.



## BELKIN KVM SWITCHES AND ACCESSORIES

### OmniView KVM Switches

**OmniView E Series.** These KVM devices allow you to control two or four computers from one console and make switching between computers more convenient. Designed for compatibility with your PS/2 platform, they reduce desktop clutter and provide a simple, reliable solution at a lower price point. High-quality resolution of up to 2048x1536@85Hz is supported through the E Series KVM Switch when used with coaxial VGA cabling, offering the highest resolution without compromising the quality of the display. Power for the KVM draws off of the keyboard, meaning no power supply is necessary and less cables to hassle with. Other standard features found on this unit include: hot key functionality; keyboard and PS/2 emulations for error-free boot up; and a Belkin Two-Year Warranty.

F1DB102P E Series 2-Port PS/2 KVM Switch  
F1DB104P E Series 4-Port PS/2 KVM Switch

**OmniView SOHO Series with Audio.** This innovative design provides built-in cable management and uses little space while adding a whole new sculpted look to your desktop. The PS/2 KVM devices allow you to control two or four computers from one console. Its convenient PS/2 compatibility makes it ideal for use with PS/2 computers. The greatest interface flexibility is yours with PS/2 and USB switches. They offer you expanded compatibility with either interface, or both, along with the additional convenience of manual push-button port selection on the face of the device. Switch between speakers and microphones without having to unplug and re-plug them when switching computers. The flash feature allows users to download firmware updates to ensure compatibility with the latest computers and devices. The designed enclosure offers cable management in a neat and convenient manner. High-quality resolution of up to 2048x1536@85Hz is supported by the SOHO KVM Switch when used with coaxial VGA cabling, offering the highest resolution without compromising the quality of the display. Power for the KVM Switch draws off of the keyboard, meaning no power supply is necessary and less cables to hassle with. Other standard features found on this unit include: hot key functionality; keyboard and PS/2 emulations for error-free boot up; and a Belkin Five-Year Warranty.

## BELKIN KVM SWITCHES AND ACCESSORIES

F1DS102P SOHO Series 2-Port PS/2 KVM Switch  
F1DS104P SOHO Series 4-Port PS/2 KVM Switch  
F1DS102T SOHO Series 2-Port PS/2 & USB KVM Switch  
F1DS104T SOHO Series 4-Port PS/2 & USB KVM Switch

**OmniView PRO Series.** These OmniView KVM Switches deliver reliability, performance, and centralized control necessary for today's enterprise environment. This series of KVM switches enables you to control multiple platform PS/2 CPU from a single console. Available in desktop-style 4-port and 19-inch rack-mountable 8-port and 16-port models, the OmniView PRO expands easily for full control of as many as 256 CPUs through dedicated daisy-chain ports. Video resolutions of up to 1600x1200@65Hz are supported. On-Screen Display allows you to name and select attached servers using an on-screen interface. Switch between ports by using hot key commands or push-button port selection. The OmniView PRO uses standard cables for easy installation, includes a 12V DC 1A power supply, and is backed by a Belkin One-Year Warranty.

F1D104-OSD PRO Series 4-Port PS/2 KVM Switch  
F1D108-OSD PRO Series 8-Port PS/2 KVM Switch  
F1D116-OSD PRO Series 16-Port PS/2 KVM Switch

**OmniView MATRIX Series.** The OmniView MATRIX 2x8 gives two users control of eight PS/2 computers, separately or simultaneously. Each user operates a separate console following a different bus path for complete independence from the other console. The OmniView MATRIX expands easily for full control of as many as 256 CPUs through dedicated daisy-chain ports and is natively rack-mountable for server room environments. Video resolutions of up to 1600x1200@65Hz are supported. On-Screen Display allows you to name and select attached servers using an on-screen interface. Switch between ports by using hot key commands or push-button port selection. The OmniView MATRIX uses standard cables for easy installation, includes a 12V DC 1A power supply, and is backed by a Belkin One-Year Warranty.

F1D208-OSD MATRIX Series 2x8-Port PS/2 KVM Switch

## BELKIN KVM SWITCHES AND ACCESSORIES

### OmniView KVM Cables

**OmniView All-In-One Cable Kits** provide you with the quality connections necessary to set up your KVM solution. Each kit provides all the cables and proper connectors to complete the installation of the Belkin OmniView Switch of your choice.

All OmniView All-In-One Cable Kits offer full compatibility with Belkin KVM switches. These cables feature sturdy construction with strain-relief and PVC overmolding to prevent data loss. Use of 20-gauge wire delivers the high performance that users identify with Belkin cables. Ferrite-bead construction reduces electromagnetic and radio frequency interference (EMI/RFI). PC99 color connectors and modified thumbscrews have been added for easier installation.

The OmniView All-In-One Cable Kits come in two levels of performance—Gold Series and PRO Series Plus.

**Gold Series** cables are top-of-the-line cables known for their 24K gold-plated connectors and Flextec™ black jackets. The 24K gold-plated connectors maximize longevity and signal integrity, and offer corrosion resistance. The Gold Series includes a custom 15-pin coaxial VGA cable to support image clarity for the highest-resolution applications. The Gold Series is available in PS/2 and USB styles.

**F3X1835-XX-GLD PS/2** (available in lengths of 6', 10', 15', and 25')

**F3X1895-XX-GLD USB** (available in lengths of 6', 10', and 15')

**PRO Series Plus** cables are modestly priced yet built to exacting standards. They receive and transmit data through nickel-plated connectors. The industry-standard 14-pin coaxial VGA cabling was designed to support image clarity for high-resolution applications. The gray jacket bends into the tightest crawl spaces. The PRO Series Plus is available in PS/2- and USB-style cable kits.

**F3X1105-XX PS/2** (available in lengths of 6', 10', 15', and 25')

**F3X1962-XX USB** (available in lengths of 6', 10', and 15')

*(-XX denotes length in feet)*

## BELKIN KVM SWITCHES AND ACCESSORIES

### OmniView Accessories and Adapters

Belkin KVM technology includes various accessories and adapters to complete your KVM solution. The Adapter Series converts Mac®, Sun®, or USB keyboards, video, and mouse signals into PS/2 and VGA.

F1D080 - **The OmniView PS/2 MAC Adapter™** converts a Macintosh® computer with a 4-pin ADB™ (Apple® Desktop Bus) and DB15 connector into a PS/2 keyboard, HDDDB15 VGA monitor, and PS/2 mouse.

F1D082 - **The OmniView PS/2 SUN Adapter™** converts a Sun 8-pin keyboard/mouse and 13W3 video into a PS/2 keyboard, PS/2 mouse, and VGA monitor.

F1D084 - **The OmniView CAT5 Extender** enables you to control a PC or KVM switch up to 500 feet (152.4m) away using standard UTP CAT5 cabling.

F1D087 - **The OmniView Keyboard Extender** allows you to extend your keyboard up to 250 feet (76.2m) away.

F1D088 - **The OmniView VGA Monitor Extender** bridges up to 250 feet (76.2m) of distance between your PC and monitor.

F1D089 - **The OmniView Keyboard Splitter** allows you to work with two kinds of PS/2 keyboards and pointing devices without swapping cables or rebooting the computer.

F1D090 - **The OmniView Mouse Splitter** allows you to work with two kinds of PS/2 mice or trackballs without swapping cables or rebooting the computer.

F1D201 - **The OmniView 2-Port Reverse KVM Switch** gives two users central control of one PC from two sets of keyboards, monitors, and mice.

F5U119 - **The Belkin PS/2-to-USB Adapter** converts PS/2 keyboard and mouse signals to USB format.

F2N017 - **PRO Series AT-to-PS/2 Keyboard Adapter** allows you to connect a keyboard with an AT-style connector to a computer with a PS/2-style connector.

## FAQ E SERIES

### FAQ E SERIES

- Q:** What operating systems does the E Series KVM Switch support?
- A:** The E Series KVM Switch will support any operating system that runs on a PS/2 platform. It will also work with Sun and Mac operating systems using the appropriate adapters (Belkin OmniView™ PS/2 SUN Adapter™ F1D082, OmniView™ PS/2 MAC Adapter™ (F1D080). Operating systems include, but are not limited to, DOS, Windows 3.x/95/98/2000/Me/NT/XP, Linux, and Mac OS.
- Q:** Does the SOHO Series KVM Switch support Microsoft® IntelliMouse®?
- A:** The SOHO Series KVM Switch supports mice from Microsoft®, Logitech®, Kensington®, etc., and Belkin manufactured mice. Please contact Belkin Technical Support for compatibility issues you may experience.
- Q:** How does the E Series KVM Switch allow the user to switch between ports?
- A:** E Series KVM Switch supports two methods of port selection. The user can select computers using specially designated keyboard hot keys, or access the desired port by pressing the front-panel port selector button.
- Q:** How far away can the second user be from the E Series KVM Switch?
- A:** When using PS/2 connections, the E Series KVM Switch can be up to 25 feet (7.5m) away from your computer. If your computer needs to be more than 25 feet (7.5m) from the KVM switch, you can use the Belkin CAT5 Extender to extend your PS/2 keyboard, PS/2 mouse, and monitor up to 500 feet (152.4) away using standard CAT5 UTP cable.
- Q:** What is the maximum video resolution that the E Series KVM Switch supports?
- A:** The advanced video circuit in the E Series KVM Switch supports a maximum resolution of 2048x1536@85Hz. Higher-resolution

## FAQ E SERIES

support is ideal for graphic artists and designers who depend on high-quality video.

- Q:** What video bandwidth does the E Series KVM Switch support?
- A:** The E Series KVM Switch supports up to 400MHz of video bandwidth.
- Q:** What is the difference between the E Series KVM Switch and the SOHO Series KVM Switch?
- A:** The SOHO Series KVM Switch offers additional audio and microphone support; a sculpted, space-saving design; cable management; flash-upgrade capability; and USB option.
- Q:** What are the benefits of the E Series KVM Switch over a similar competitor product?
- A:** The E Series KVM Switch is an affordable solution packed with features that are found in units that are higher in price. The E Series KVM switch offers hot key command switching, resolution support of up to 2048x1536@85Hz, AutoScan, a Belkin Two-Year Limited Warranty, and a price that cannot be matched.
- Q:** Do I have to install any software to use the E Series KVM Switch?
- A:** No, the E Series KVM Switch does not require any drivers or software to be installed on your computers. Simply connect all your computers to the PC ports on the KVM switch, then attach one keyboard, monitor, and mouse to the CONSOLE port and it is ready for use.
- Q:** Does the E Series KVM Switch require an AC adapter?
- A:** The E Series KVM Switch can be powered by the PS/2 keyboard port of your computer. An optional 9V DC, 600mA power adapter with center pin positive polarity may be used for instances where power cannot be drawn from a PS/2 port of a computer.

## FAQ E SERIES

**Q:** Can I use the E Series KVM Switch to switch video signals only?

**A:** Yes, you may use the E Series KVM Switch to switch between video signals only, without having to connect the keyboard and mouse. Keyboard and mouse should be connected directly to the computer that the video signal is taken from to insure that your computer functions properly.

**Note:** *The E Series KVM will require the use of the optional AC power adapter since power cannot be drawn from the computer via the keyboard or through a USB port.*

**Q:** Can I use the E Series KVM Switch on my Sun computer?

**A:** Yes, the E Series KVM Switch works with Sun computers when used with the Belkin OmniView PS/2 SUN Adapter (F1D082).

**Q:** How long is the warranty for the E Series KVM Switch?

**A:** The E Series KVM Switch comes with a Two-Year Limited Warranty.

## TROUBLESHOOTING

### TROUBLESHOOTING

#### VIDEO

***I am getting ghosting, shadowing, or fuzzy images on my monitor.***

- Check that all video cables are inserted properly.
- Check that the monitor you are using supports the resolution and refresh-rate setting on your computer.
- Check that the graphics card you are using supports the resolution and refresh-rate setting on your computer.
- Connect the monitor directly into the computer you are having trouble with to see if the problem still appears.

***I am getting a black screen on my monitor.***

- Check that all video cables are inserted properly.
- If you are not using a power adapter, check that the keyboard cable is connected and inserted properly between the computer and KVM for the appropriate port.
- If you are using the KVM for video switching only and have no keyboard and mouse connection between the KVM and computer, you will need to purchase the Optional 9V DC, 600mA power adapter (F1D065-PWR for your appropriate country).
- Connect your monitor directly to the computer to verify that your monitor is functioning properly.

#### KEYBOARD

***Computer does not detect keyboard and I get a Keyboard Error reported at boot up.***

- Check that the keyboard cable between the KVM switch and the computer is connected properly. Tighten any loose connections.
- Try swapping your keyboard with a different one.
- Try connecting the computer to a different port.

## TROUBLESHOOTING

- If you are using the keyboard software that was included with your keyboard, uninstall it and install the standard Microsoft keyboard driver.

### MOUSE

#### ***Mouse is lost when I switch to a different channel.***

- Check that the mouse you are using is connected properly to the console of the KVM switch.
- If you are using a mouse driver that was included with your mouse, uninstall it and install the standard Microsoft mouse driver.
- Disconnect and reconnect the mouse cable attached to the channel with which you are experiencing problems to resynchronize the mouse connection.
- Attach the mouse directly to the computer you are experiencing mouse problems with.
- Allow up to one minute following the computer's waking from standby mode for mouse function to return.
- Deactivate power-management schemes on the PC that you are experiencing problems with.
- Try swapping the mouse with a different one.

#### ***The mouse is not detected at boot up.***

- Check the cables and make sure that they are inserted properly.

#### ***The computer boots up fine, but the mouse does not work.***

- Make sure it is plugged in properly.
- Make sure the mouse works when directly plugged into the computer. Rebooting may be necessary when trying this.
- Try a different mouse.

## TROUBLESHOOTING

#### ***When I switch from one port to another, mouse movement is completely erratic.***

- Make sure you do not have more than one mouse driver installed. Make sure that the driver is either for a standard PS/2 mouse or a Microsoft compatible PS/2 mouse.
- Make sure you do not have any mouse drivers loaded in your CONFIG.SYS or AUTOEXEC.BAT files.
- Avoid moving the mouse or pressing the mouse button when switching ports on the E Series KVM switch.
- You can reset the mouse and resume proper mouse movement simply by unplugging the mouse from the front of the E Series KVM Switch and waiting about 2-3 seconds before plugging it in again.

### GENERAL

#### ***My computer does not boot when connected to the E Series KVM Switch but works fine when I connect the keyboard, video, and mouse directly to it.***

- Make sure that the keyboard and mouse cables are connected tightly between the KVM Switch and the computer.
- Check that the keyboard and mouse cables are not crossed.

## Warranty, FCC, CE Statement

### FCC Statement

#### DECLARATION OF CONFORMITY WITH FCC RULES FOR ELECTROMAGNETIC COMPATIBILITY

We, Belkin Components, of 501 West Walnut Street, Compton CA 90220, declare under our sole responsibility that the product:

F1DB102P

F1DB104P

to which this declaration relates:

Complies with Part 15 of the FCC Rules. Operation is subject to the following two conditions: (1) this device may not cause harmful interference, and (2) this device must accept any interference received, including interference that may cause undesired operation.

### CE Declaration of Conformity

We, Belkin Components, declare under our sole responsibility that the F1DB102P and F1DB104P, to which this declaration relates, is in conformity with Emissions Standard EN55022 and with Immunity Standard EN55024, LVP EN61000-3-2, and EN61000-3-3.

### Belkin Components Limited Two Year Product Warranty

Belkin Components warrants this product against defects in materials and workmanship for its warranty period. If a defect is discovered, Belkin will, at its option, repair or replace the product at no charge provided it is returned during the warranty period, with transportation charges prepaid, to the authorized Belkin dealer from whom you purchased the product. Proof of purchase may be required.

This warranty does not apply if the product has been damaged by accident, abuse, misuse, or misapplication; if the product has been modified without the written permission of Belkin; or if any Belkin serial number has been removed or defaced.

THE WARRANTY AND REMEDIES SET FORTH ABOVE ARE EXCLUSIVE IN LIEU OF ALL OTHERS, WHETHER ORAL OR WRITTEN, EXPRESSED OR IMPLIED. BELKIN SPECIFICALLY DISCLAIMS ANY AND ALL IMPLIED WARRANTIES, INCLUDING, WITHOUT LIMITATION, WARRANTIES OF MERCHANTABILITY AND FITNESS FOR A PARTICULAR PURPOSE.

No Belkin dealer, agent, or employee is authorized to make any modification, extension, or addition to this warranty.

BELKIN IS NOT RESPONSIBLE FOR SPECIAL, INCIDENTAL, OR CONSEQUENTIAL DAMAGES RESULTING FROM ANY BREACH OF WARRANTY, OR UNDER ANY OTHER LEGAL THEORY, INCLUDING BUT NOT LIMITED TO LOST PROFITS, DOWNTIME, GOODWILL, DAMAGE TO OR REPROGRAMMING, OR REPRODUCING ANY PROGRAM OR DATA STORED IN OR USED WITH BELKIN PRODUCTS.

Some states do not allow the exclusion or limitation of incidental or consequential damages or exclusions of implied warranties, so the above limitations of exclusions may not apply to you. This warranty gives you specific legal rights, and you may also have other rights that vary from state to state.



**Belkin Components**  
501 West Walnut Street  
Compton • CA • 90220 • USA  
Tel: 310.898.1100  
Fax: 310.898.1111

**Belkin Components, Ltd.**  
Unit 13 • Gatelodge Close • Round Spinney  
Northampton • Northants • NN3 8RX • United Kingdom  
Tel: +44 (0) 1604678300  
Fax: +44 (0) 1604678330

**Belkin Components B.V.**  
Belkin Components B.V.  
Starparc Building • Boeing Avenue 333  
1119 PH Schiphol-Rijk • The Netherlands  
Tel: +31 (0) 20 654 7300  
Fax: +31 (0) 20 654 7349

**Belkin Components, Ltd.**  
7 Bowen Crescent • West Gosford  
NSW 2250 • Australia  
Tel: +61 (2) 4325 4666  
Fax: +61 (2) 4325 4277



## Free Manuals Download Website

<http://myh66.com>

<http://usermanuals.us>

<http://www.somanuals.com>

<http://www.4manuals.cc>

<http://www.manual-lib.com>

<http://www.404manual.com>

<http://www.luxmanual.com>

<http://aubethermostatmanual.com>

Golf course search by state

<http://golfingnear.com>

Email search by domain

<http://emailbydomain.com>

Auto manuals search

<http://auto.somanuals.com>

TV manuals search

<http://tv.somanuals.com>