

**BOSE**

# 3•2•1<sup>®</sup> GS SERIES III

## 3•2•1 SERIES III

DVD HOME ENTERTAINMENT SYSTEM

Owner's Guide

Guía de usuario



Notice d'utilisation



# SAFETY INFORMATION



## Please read this owner's guide

Please take the time to follow this owner's guide carefully. It will help you set up and operate your system properly and enjoy all of its advanced features. Save this owner's guide for future reference.

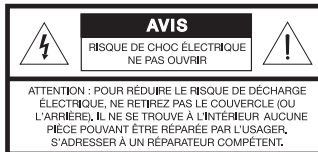
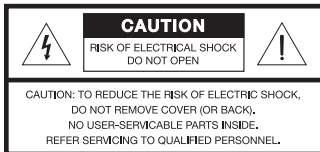
-  **WARNING:** To reduce the risk of fire or electric shock, do not expose the system to rain or moisture.
-  **WARNING:** Do not expose this apparatus to dripping or splashing, and do not place objects filled with liquids, such as vases, on or near the apparatus. As with any electronic product, use care not to spill liquids in any part of the system. Liquids can cause a failure and/or a fire hazard.



The CAUTION marks shown here are located on the bottom of your 3•2•1® home entertainment system media center and the rear panel of the Acoustimass® module:

-  The lightning flash with arrowhead symbol within an equilateral triangle alerts the user to the presence of uninsulated, dangerous voltage within the system enclosure that may be of sufficient magnitude to constitute a risk of electric shock.
-  The exclamation point within an equilateral triangle alerts the user to the presence of important operating and maintenance instructions in this owner's guide.

 **CAUTION:** To prevent electric shock, match wide blade of plug to wide slot, insert fully.

 **CAUTION:** Do not place any naked flame sources, such as lighted candles, on or near the apparatus.

## Class 1 laser product

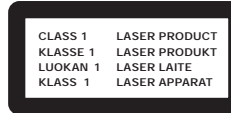

This CD player is classified as a CLASS 1 LASER PRODUCT according to EN 60825-1:1994+A1+A2, IEC60825-1:1993+A1+A2.

-  **CAUTION:** Use of controls or adjustments or performance of procedures other than those specified herein may result in hazardous radiation exposure. The DVD player should not be adjusted or repaired by anyone except properly qualified service personnel.

## Class B emissions limits

This Class B digital apparatus meets all requirements of the Canadian Interference-Causing Equipment Regulations.



## Batteries

Please dispose of used batteries properly, following any local regulations. Do not incinerate.

-  This product conforms to the EMC Directive 2004/108/EC and to the Low Voltage Directive 2006/95/EC. The complete Declaration of Conformity can be found at: [www.Bose.com/static/compliance/index.html](http://www.Bose.com/static/compliance/index.html).

## Additional safety information

See the additional instructions on the *Important Safety Information* sheet enclosed in the shipping carton.

**INTRODUCTION 2**

Before you begin .....	2
For your records .....	3
Unpacking .....	4

**SETUP 6**

<b>1</b> Placing the system components 6	
<b>2</b> Connecting the speakers to the module .....	8
<b>3</b> Connecting the module to the media center ....	10
<b>4</b> Connecting the system video to your TV .....	12
<b>5</b> Connecting a cable box or other component ...	17
To connect another component .....	19
To get digital audio from the component .....	20
To use video pass through .....	21
<b>6</b> Connecting audio from your TV as an option 22	
<b>7</b> Installing the FM and AM radio antennas .....	25
<b>8</b> Connecting the module to a power outlet .....	28
<b>9</b> Setting the remote to control your TV and components .....	30
Inserting the remote batteries .....	30
Setting the remote for your TV .....	31
Controlling another component .....	32

**FIRST-TIME USE 33**

Trying out the DVD .....	33
--------------------------	----

**CONTROLS AND INDICATORS 34**

The remote control .....	34
Power and source buttons .....	35
Menu and movement buttons .....	36
Play and numeric buttons .....	37
Record and A, B, C buttons (not in Europe) .....	38
Colored buttons (in Europe only) .....	38
The media center .....	39
Display .....	39
Disc tray .....	39

**OPERATION 40**

Playing a video disc or CD .....	40
Selecting a play option .....	40
Keeping your discs clean .....	41
Checking for disc compatibility .....	42
For DVDs: Setting Parental Control .....	42
Choosing a password .....	42
Setting a restriction level .....	43
Ratings supplied by the MPAA .....	43

Playing a cable box or other component . . . . .	44
Adjusting for audio delay . . . . .	44
Getting digital audio from a source . . . . .	45
Choosing other options . . . . .	45
Listening to the radio . . . . .	46
Creating a preset . . . . .	46
Removing a station from a preset . . . . .	46
<b>ADJUSTMENTS TO THE PERFORMANCE</b>	<b>47</b>
<hr/>	
Changing system features . . . . .	47
To get to the System menu . . . . .	47
Selecting a new option . . . . .	48
Language choices . . . . .	48
Audio options . . . . .	49
Video options . . . . .	50
Media center options . . . . .	52
Choosing new settings . . . . .	53
To get to the Settings menu . . . . .	53
Settings options . . . . .	54

<b>REFERENCE</b>	<b>59</b>
<hr/>	
Replacing remote batteries . . . . .	59
Protecting the system . . . . .	59
Cleaning the media center . . . . .	59
Cleaning the speakers . . . . .	59
Troubleshooting . . . . .	60
For customer service . . . . .	63
Limited warranty . . . . .	63
Technical information . . . . .	64

<b>COPYRIGHT AND LICENSE PROTECTIONS</b>	<b>69</b>
<hr/>	

<b>DEVICE CODES</b>	<b>A-1</b>
<hr/>	



# INTRODUCTION

---

## Before you begin

---

Thank you for purchasing the 3•2•1® DVD home entertainment system. Using Bose® proprietary signal processing technology, the 3•2•1 system provides improved spaciousness from stereo recordings and bold movie effects for surround-sound sources.

System features include:

- Small, easy-to-place shelf speakers
- Easy-to-hide Acoustimass® module
- Integrated DVD/CD player and AM/FM tuner
- Remote and media center controls
- HDMI video connection to your TV
- Audio In connectors for three components
- Your choice of language for text displays



## INTRODUCTION

# Unpacking

Carefully unpack your system. Save all packing materials, which provide the safest way to transport your system. Make sure your system includes the parts shown.

**WARNING:** To avoid danger of suffocation, keep the plastic bags out of the reach of children.

As you identify them, you may want to place a check mark in the box next to the name of each part.

If any part of the system appears damaged, do not try to use it. Notify Bose or your authorized Bose® dealer right away. For contact information, refer to the address sheet included in the carton.

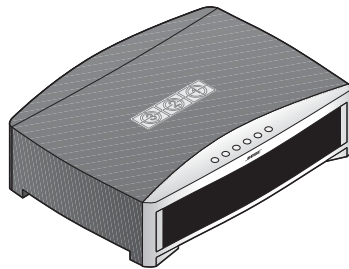

Media center

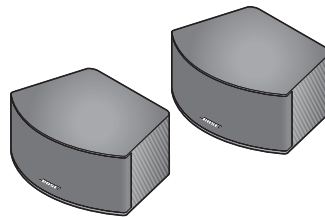

3•2•1® GS speakers

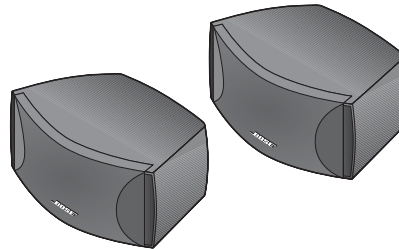

3•2•1 speakers



Acoustimass® module



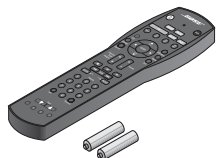

❑ Remote control and batteries



❑ Rubber feet for Acoustimass® module



❑ Rubber feet for speakers

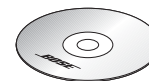

❑ Setup disc

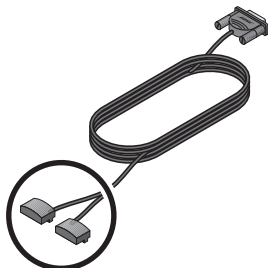

❑ Speaker cable

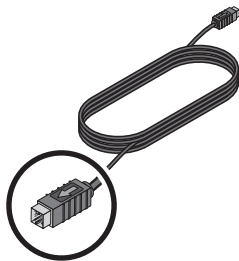

❑ Acoustimass module cable

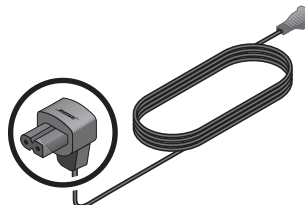

❑ Acoustimass module power cord

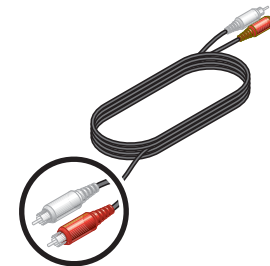

❑ Stereo audio cable



❑ HDMI video cable

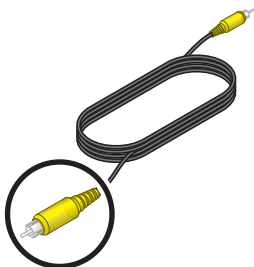

❑ Composite video cable

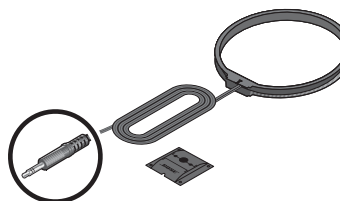

❑ AM antenna and stand

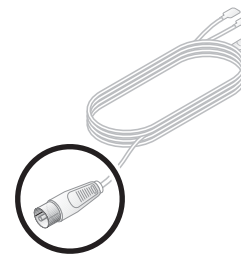

❑ FM antenna

# SETUP

## 1

## Placing the system components

What you need to use:



Media center

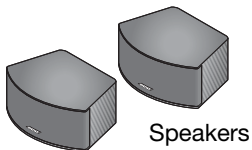

Speakers

OR

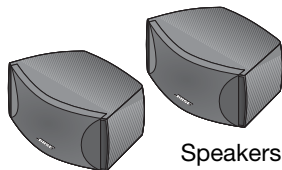

Speakers



Acoustimass® module

The image below shows one of the many ways you can position your new 3•2•1® system.

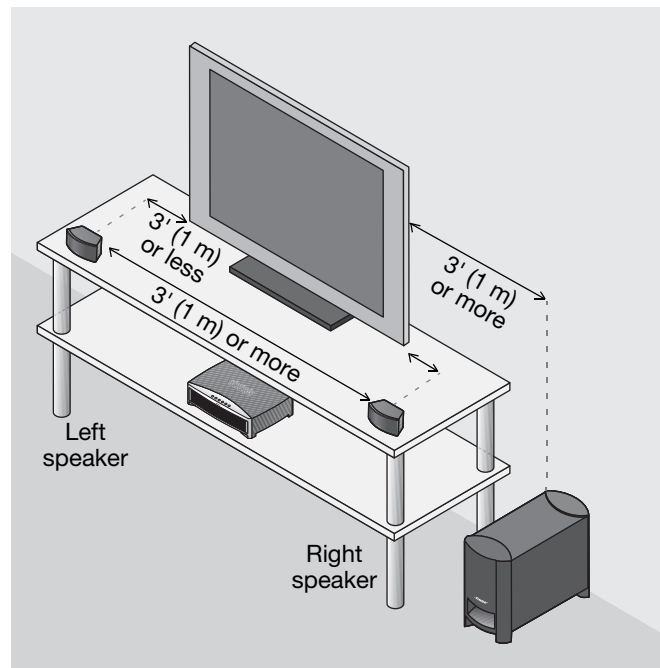

See Steps 1-6 for details.

1. On the bottom of each speaker, attach one set of small rubber feet.

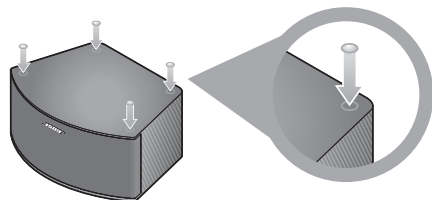

2. Place the left and right speakers:
  - at least 3 feet (1 meter) apart
  - within 3 feet (1 meter) of the TV screen
  - near the front edge of any shelf
  - aimed straight ahead (not angled) to face the listening area
3. On the legs of the Acoustimass® module, attach the large rubber feet.

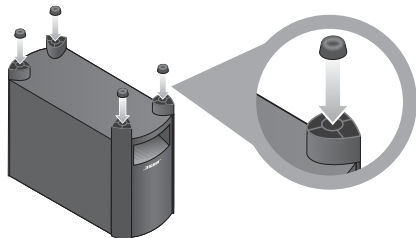

4. Place the Acoustimass module:
  - at the same end of the room as the speakers and your TV
  - at least 3 feet (1 meter) from the TV to prevent interference with the screen
  - several feet (.8 meters) from audio or video tapes to prevent magnetic damage to them
  - standing upright, not lying on a side, the front, or the back
  - with the front port aimed out from or along a wall for balanced performance
  - hidden under a table, behind a sofa or chair, or behind drapes as preferred
  - NOT in an enclosure, on a bed, on a sofa, or on a surface that can block the ventilation openings.

---

**CAUTION:** Do not block ventilation openings on the bottom and rear of the module.

---

5. Place the media center:
  - where nothing obstructs the front panel
  - near any components you will connect
6. Continue with **2** on the next page.



## SETUP

## 2 Connecting the speakers to the module

What you need to use:

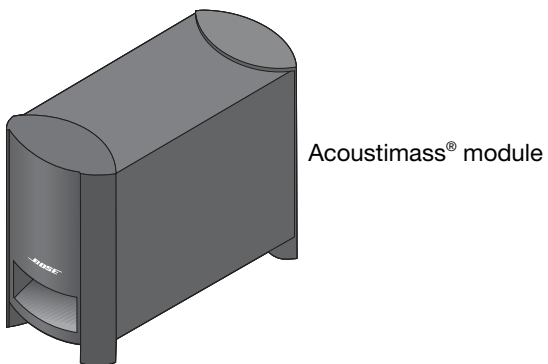
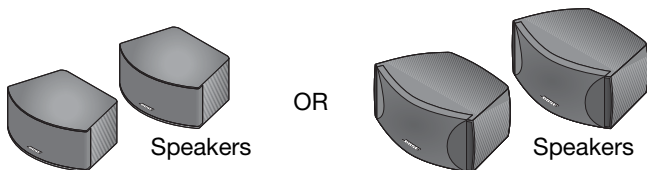

1. Notice the two plugs at one end of the speaker cable.

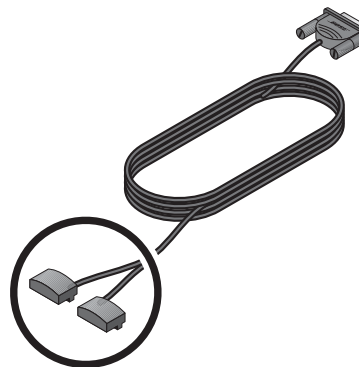

2. Separate the two plugs so each one reaches a speaker.

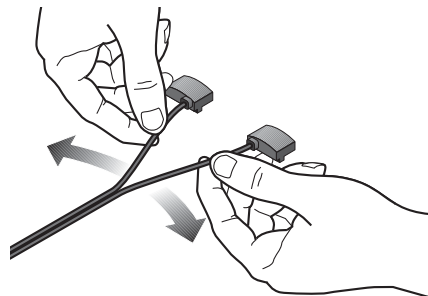

(Refer to **1** for placement guidelines.)

3. Insert each plug into the connector on the proper speaker.

The plug marked RIGHT goes into the speaker placed to the right of your TV.

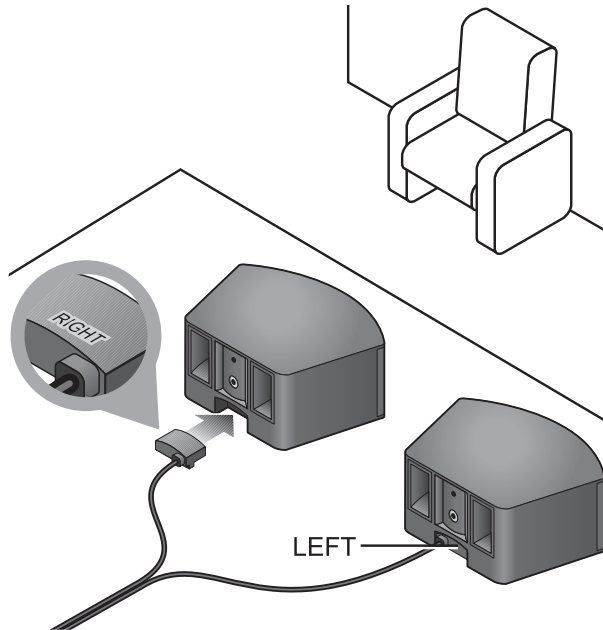

4. Insert the remaining single plug into the connector labeled SPEAKERS on the back of the Acousti-mass® module.

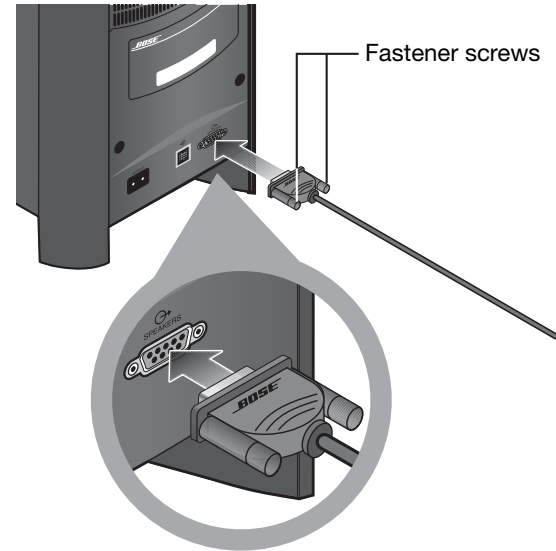

5. Tighten each fastener screw by hand to secure the plug.

---

**CAUTION:** Do not plug the Acousti-mass module into an AC power (mains) outlet until all other components are connected.

---

6. Continue with **3** on the next page.

## SETUP

## 3

## Connecting the module to the media center

What you need to use:

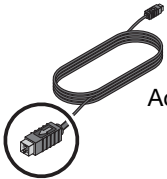

Acoustimass® module cable



Media center



Acoustimass module

1. Notice the arrow on the top of the multi-pin plug at each end of the Acoustimass module cable.

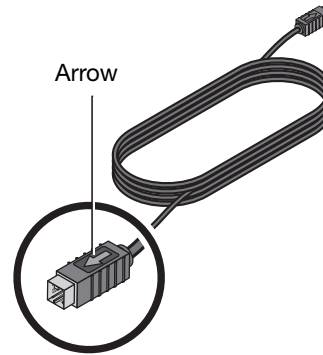

2. Make sure you can see the arrow on top before you insert either end of the cable.

3. Insert this plug into the connector labeled  on the back of the Acoustimass® module.

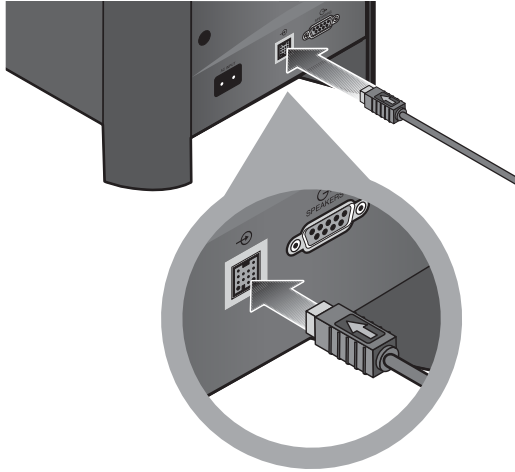

Make sure the arrow on the plug faces up as you insert it.

4. On the other end of the cable, make sure you can see the arrow on top of the plug.
5. Insert this plug into the connector labeled Acoustimass Module on the back of the media center.

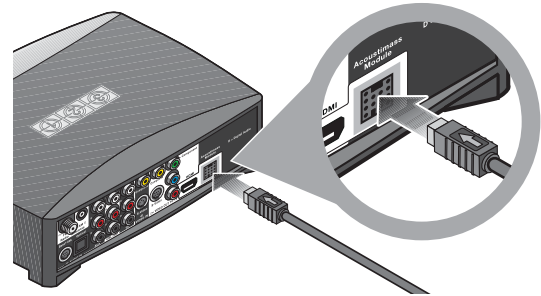

6. Continue with **4** on the next page.

## SETUP

# 4

## Connecting the system video to your TV

What you may need to use:



HDMI  
video cable

OR

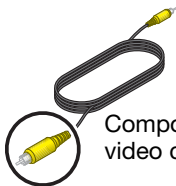

Composite  
video cable



Media center

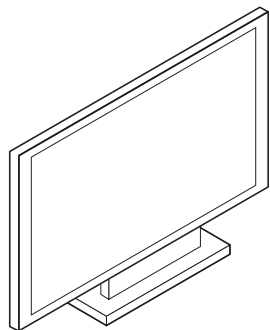

Your TV

This connection allows you to see DVDs and other video from the 3•2•1® system on your TV.

1. Select the HDMI video cable.





2. Check to see if your TV has an unused HDMI connector for VIDEO IN.

This may be located on the side or rear connector panel of the TV.

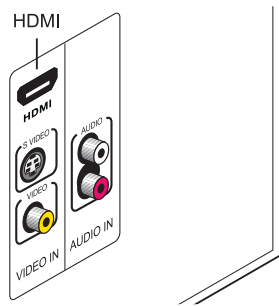

3. Follow the directions that are appropriate for your TV:

**TV with HDMI** on page 14

or

**TV without HDMI** on page 15

## SETUP

TV with HDMI

1. Insert one end of the HDMI cable into the HDMI connector on your TV.

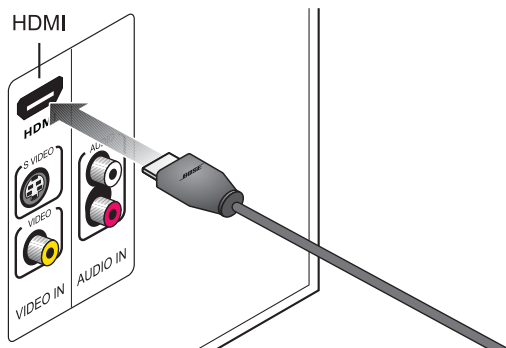

Match the wide side of the plug to the wide side of the connector.

2. Insert the other end of this cable into the HDMI connector on the media center.

Make sure the Bose® logo shows as you insert the plug.

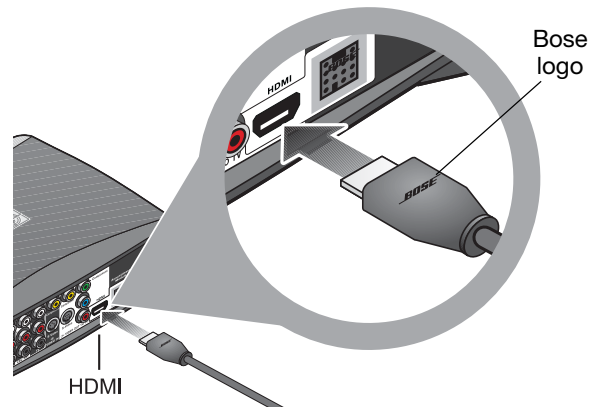

3. Continue with **5** on page 17.

**Note:** If you make this HDMI connection, you do not need the supplied yellow Composite video cable to make any connections.

DO NOT use either of the two ONLY PASS-THROUGH connectors on the back of the media center for video from a component. Neither S-Video nor Composite signals can pass through the HDMI cable to the TV.

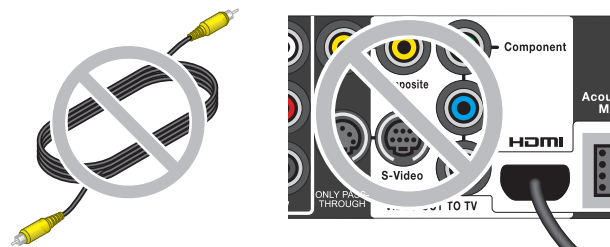

## TV without HDMI

1. Notice the yellow plug at each end of the Composite video cable.

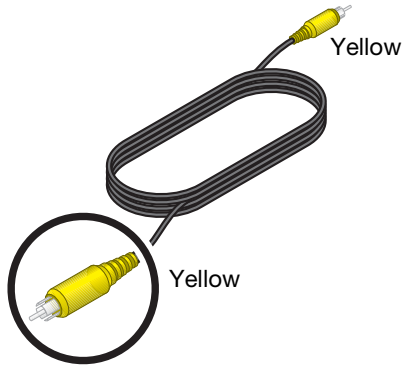

---

**Note:** There may be other kinds of video connectors on your TV that offer higher resolution than Composite. To use either S-Video or Component connectors, you need the appropriate cables. These cables are available at most electronics stores.

---

2. Plug the Composite video cable into the yellow VIDEO IN connector on your TV.

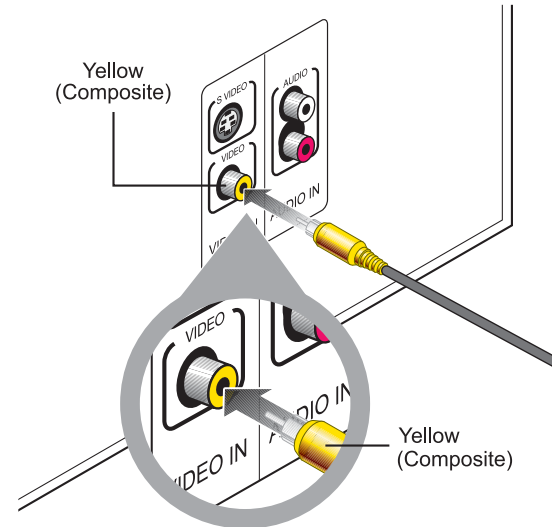

---

**Note:** If there is just one Composite Video In connector on your TV, it may be in use already for another video component. You can disconnect that component from the TV, and see "To use video pass through" on page 21.

---

## SETUP

3. Insert the other end into the yellow Composite VIDEO OUT connector on the back of the media center.

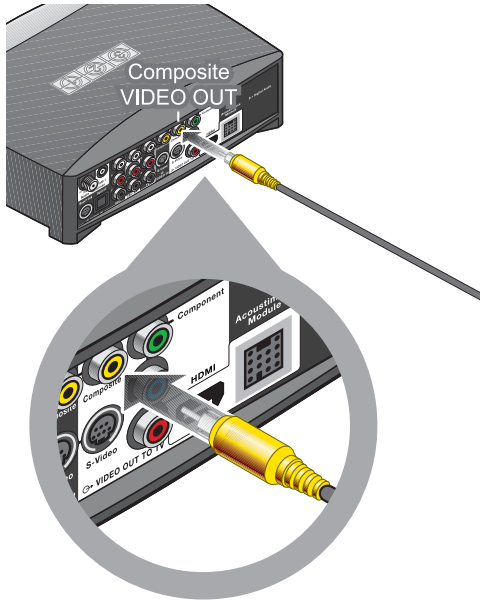

.a

---

**Note:** If you make this Composite connection, you can use the *ONLY PASS-THROUGH* connector on the media center for video from another component. See “To use video pass through” on page 21 for further information.

---

4. Continue with **5** on the next page.

# 5 Connecting a cable box or other component

What you need to use:

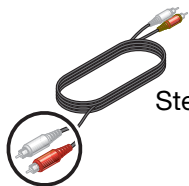

Stereo audio cable

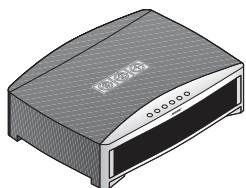

Media center

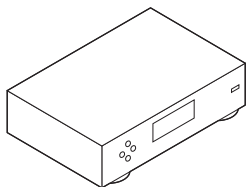

Your cable box, satellite box, or other component

You can listen to another sound source — like a cable or satellite box — through the 3•2•1® speakers instead of your TV.

This requires an audio connection only. Leave the video from your component connected to your TV.

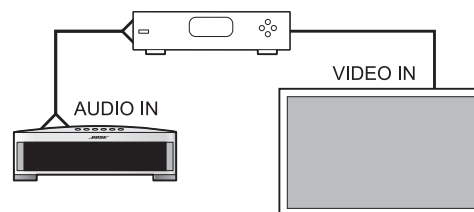

5. Select the audio cable that has red and white plugs at each end.

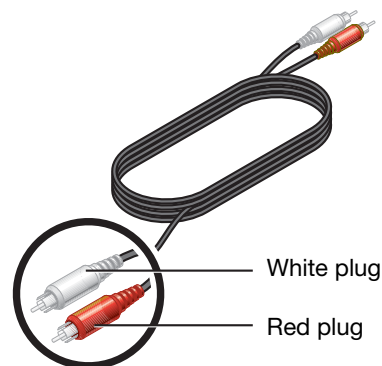

## SETUP

6. Check to see if your cable or satellite box has red and white AUDIO OUT connectors.

A red and white audio cable may (a) or may not (b) already be attached to these connectors.

a.

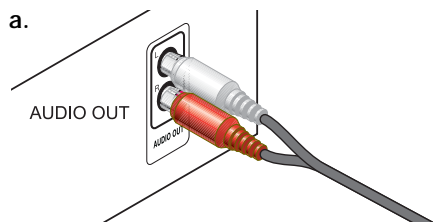

OR

b.

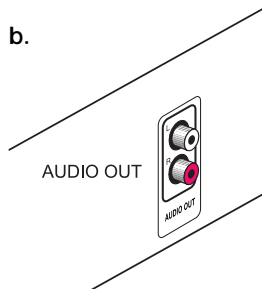

- c. If there are no AUDIO OUT connectors at all, continue with **6** on page 22.

3. To use the AUDIO OUT connectors, follow a or b as appropriate.

**a. If an audio cable is already attached**

Disconnect the cable from the TV only.

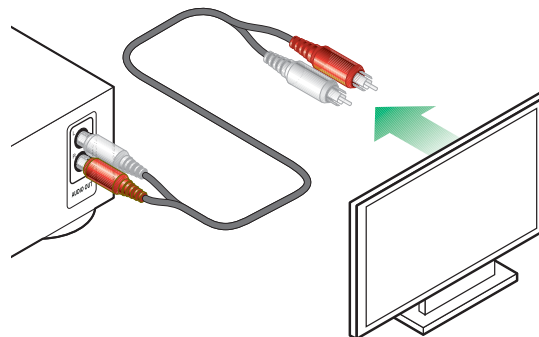

**b. If an audio cable is not yet attached**

Connect the cable to your cable or satellite box. Be sure to connect red to red and white to white.

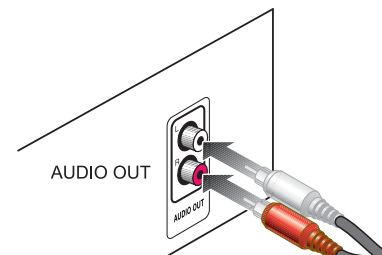

4. Insert the plugs at the other end of the audio cable into the CBL•SAT AUDIO IN connectors on the media center.

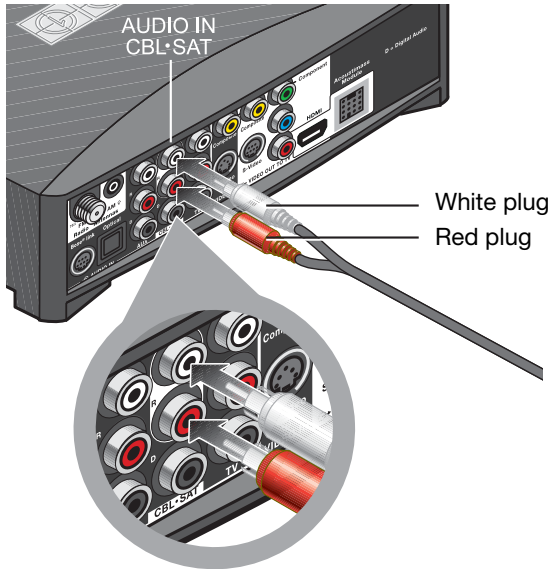

## To connect another component

In addition to your cable or satellite box, you can connect a second component, like a VCR. For this you need another audio cable with red and white plugs, available at most electronics stores.

1. Use this additional cable to connect to the AUDIO OUT on your component. Follow the method used in steps 1-3 on the previous pages.
2. Connect the other end of this cable to the AUDIO IN AUX on the 3•2•1® system media center.

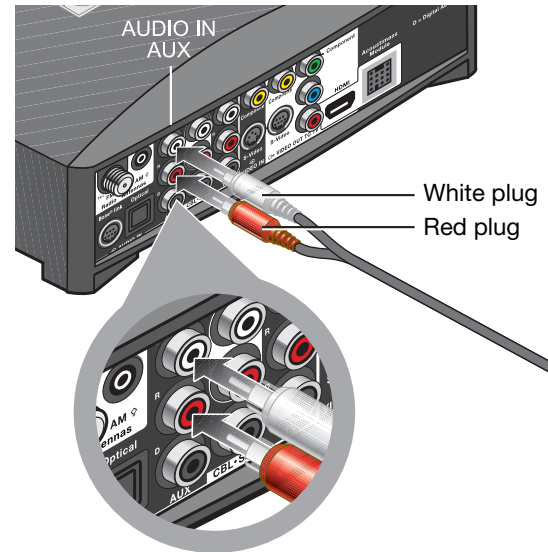

## SETUP

## To get digital audio from the component

For a component that is already connected to the media center, you can make a digital audio connection too.

For this higher quality audio, you need a digital audio cable that works with your component. Such cables are available at most electronics stores.

1. Identify the digital connector on your component as either an Optical or Coaxial connector.

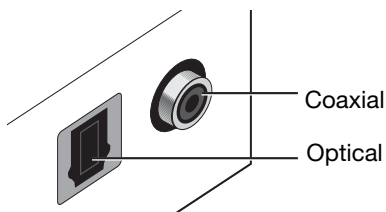

2. Be sure to use the right cable for this connector.

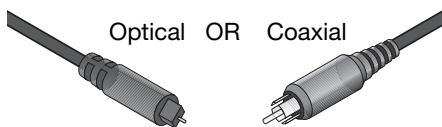

---

**Note:** If your component has an Optical and a Coaxial connector, use either one but not both.

---

3. Connect one end of your digital cable to the digital AUDIO OUT connector on your component.

Be sure to keep the red and white audio cable connected. This allows you to hear the audio if the program audio is not digital or the digital signal is interrupted.

4. Locate the appropriate digital AUDIO IN connector, labeled D, on the system media center.

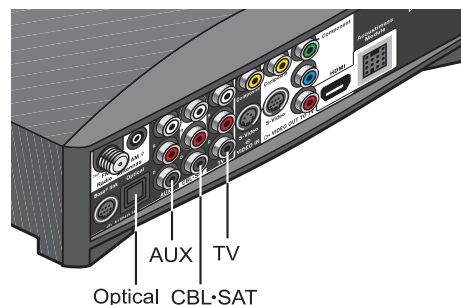

You can make:

- up to 3 coaxial connections
- up to 2 coaxial and one optical connection

---

**Note:** The media center Optical connector is factory set to work with a cable or satellite box. If your Optical component is neither of those, you need to select your component in an on-screen System menu. See “Getting digital audio from a source” on page 45.

---



5. Plug the other end of your digital cable into the appropriate AUDIO IN connector on the media center.

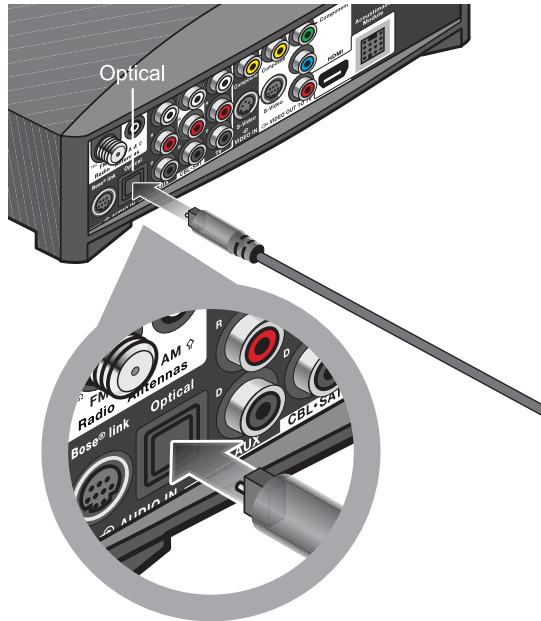

The example here shows an Optical digital connection only.

## To use video pass through

This calls for another composite cable or two S-Video cables, which are available at most electronics stores.

You can make a pass through connection if:

- You have a Composite or S-Video connection between the TV and the media center (not HDMI or Component).

AND:

- You want to connect another video component through the media center to the TV.

Be sure to use one matched pair as shown here:

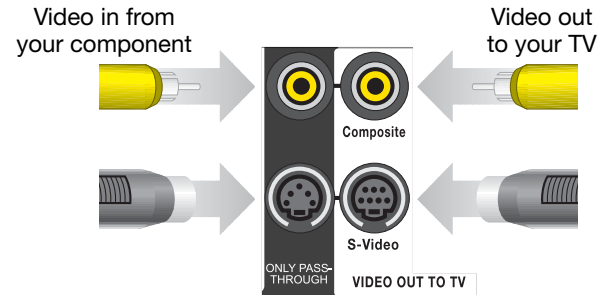

DO NOT use either of the two ONLY PASS-THROUGH connectors (on the left) if you have made an HDMI or Component connection VIDEO OUT TO TV.

Continue with **6** on the next page.

## 6

## Connecting audio from your TV as an option

What you need to use:

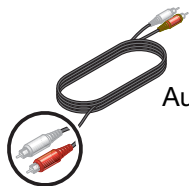

Audio cable



Media center

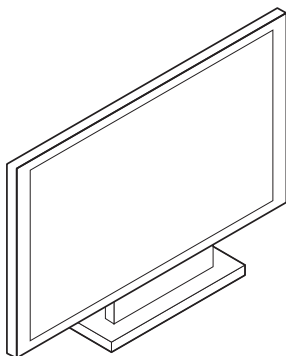

Your TV

For some setups, in order to hear your TV sound from your 3•2•1® speakers, you need to make this connection.

If:

- Your cable box does not provide red and white AUDIO OUT connectors.
- You watch TV programs without using a cable or satellite box.
- You connect a video camera or game console to your TV.

If none of the above apply, continue with **7** on page 25.

---

**Note:** If you have already connected the audio cable provided with the system, you need another cable for this connection. These cables are available at most electronics stores.

---

1. Insert the red and white plugs at one end of the cable into the AUDIO OUT connectors on the TV.

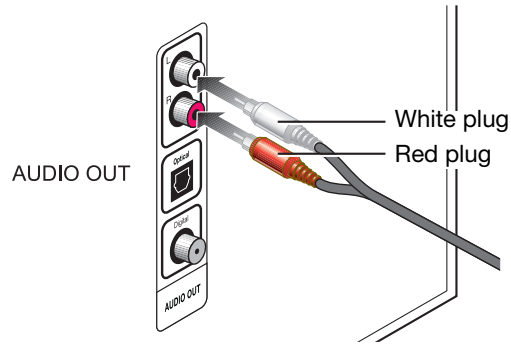

Be sure to match red to red and white to white.

---

**Note:** In addition to this connection, you can make a digital AUDIO OUT connection from the TV to the media center. For more information, review “To get digital audio from the component” on page 20.

---

---

**Note:** If your TV does not provide AUDIO OUT connectors, you cannot connect the TV audio to the 3•2•1® system. Continue to use your TV speakers for TV program audio.

The audio from other components that are connected to the 3•2•1 media center will play through the 3•2•1 speakers.

---

## SETUP

2. Insert the red and white plugs at the other end of this cable into the AUDIO IN TV connectors on the media center.

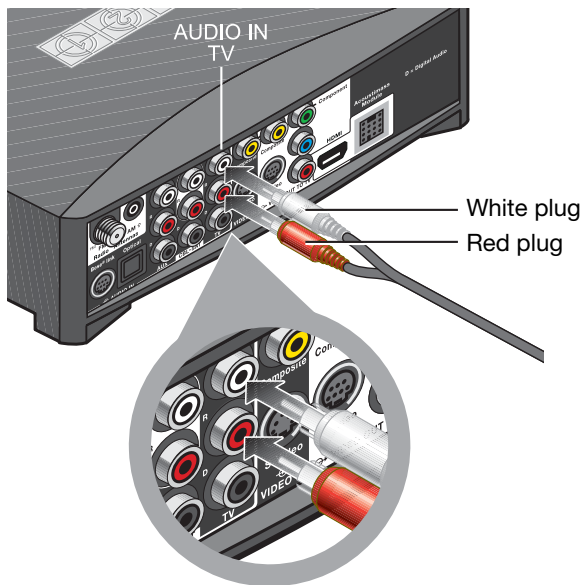

Be sure to match red to red and white to white.

3. Use your TV remote control to turn the TV speakers down to minimum volume.

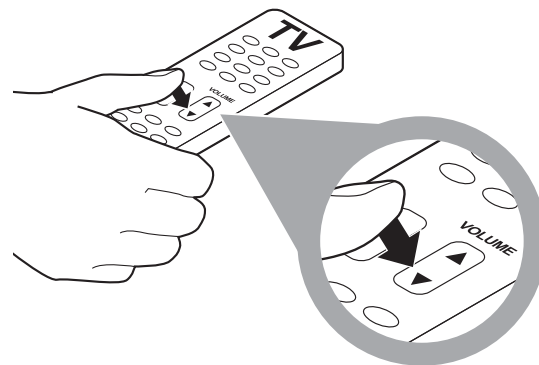

This prevents the echo effect of audio playing through both the TV speakers and your 3•2•1® system speakers.

# 7 Installing the FM and AM radio antennas

What you need to use:

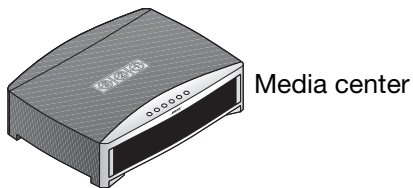
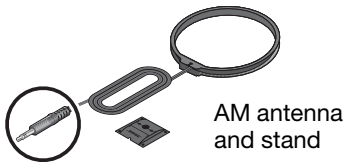

For radio reception of broadcast radio programs, you need to use the supplied antennas.

**For FM:**

1. Select the FM antenna.

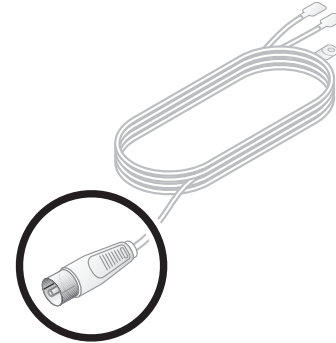

2. Insert the antenna plug into the FM antenna connector.

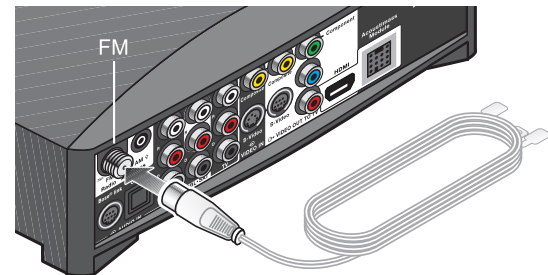

**SETUP**

3. Straighten the antenna cable and spread the two ends far apart.



You may need to raise the ends and adjust the position to get clear reception.

**For AM:**

1. Select the AM antenna and stand.

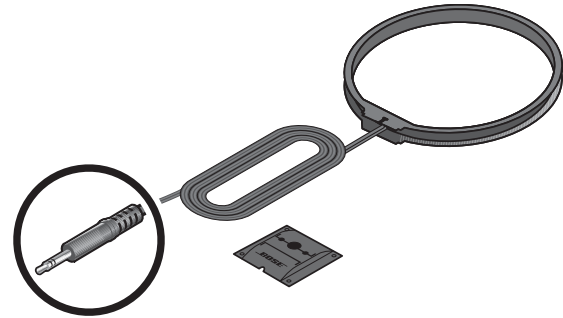

2. Insert the antenna plug into the AM antenna connector.

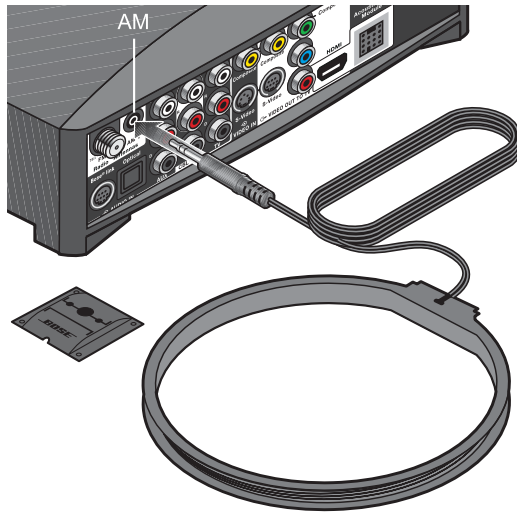

3. Press firmly to attach the antenna loop to the provided stand.

Small tabs on the antenna ring fit into notches on the stand.

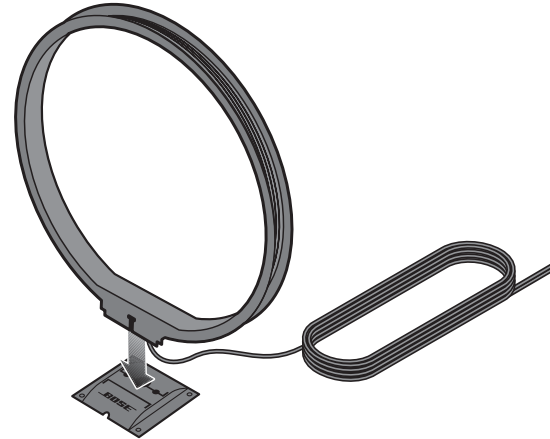

4. Place the antenna in an upright position and at least 20 inches (50 centimeters) from both the media center and the Acoustimass® module.
5. Continue with **8** on the next page.

## SETUP

## 8

## Connecting the module to a power outlet

What you need to use:

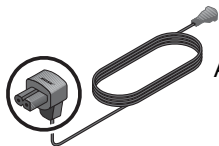

Acoustimass® module power cable

1. Notice the large plug at one end of the Acoustimass module power cable.

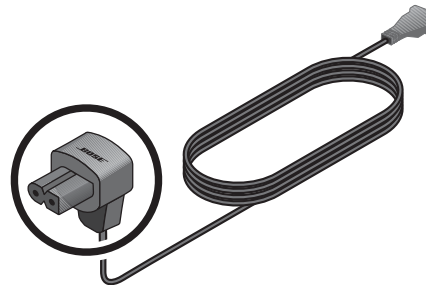

Acoustimass module



2. Insert this plug into the power connector that is marked ~ on the Acoustimass® module.

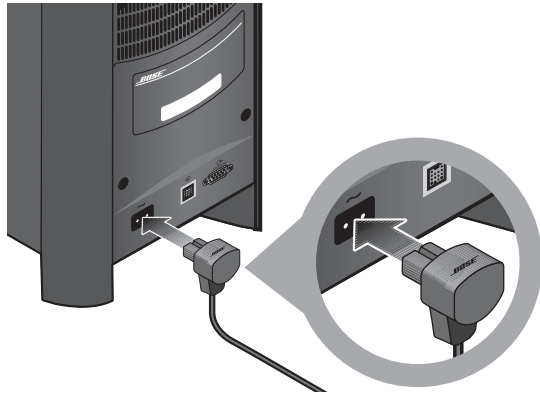

**Note:** On some systems, the Acoustimass module includes one of two controls.

**On 220-240V models only,** turn the POWER switch to on (I).



**On dual-voltage systems only,** set the voltage switch for the power that is appropriate to the region where you use the system.



3. Plug the other cable end into the AC (mains) power.

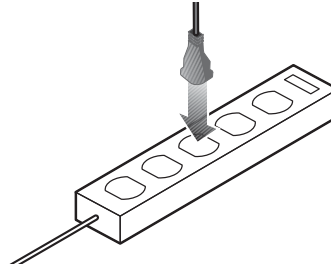

**CAUTION:** Bose recommends using a safety agency-approved surge protector on all electronic equipment. Voltage variations and spikes can damage electronic components in any system.

**Note:** Surge protectors are available at most electronics stores.

4. Continue with **9** on the next page.

## SETUP

# 9 Setting the remote to control your TV and components

What you need to use:



Remote control and batteries

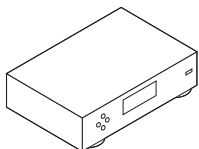

Your component

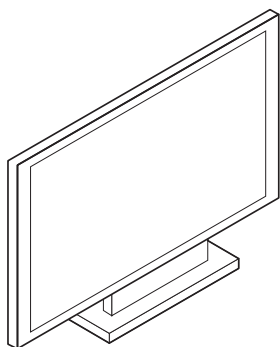

Your TV

When the batteries are installed, you can set the 3•2•1® remote to control your TV and other components connected to the media center.

## Inserting the remote batteries

The two supplied AA batteries go into the compartment on the back of the remote control.

1. Slide the battery compartment cover off.

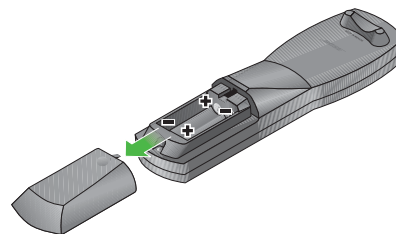

Symbols inside the compartment show how to match the – and + symbols on the batteries.

2. Insert the two batteries, making sure to match the markings.

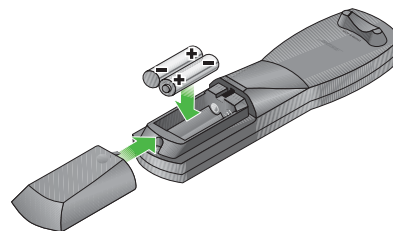

3. Slide the cover back until it clicks into place.

## Setting the remote for your TV

To use the 3•2•1® remote with your TV, you must set the remote for the proper TV device code.

1. Refer to the list of “Device codes” on page A-1.
2. In the list for TVs, find the brand of your TV.
3. Write down several codes for your brand so you can try more than one, if needed.

---

**Note:** *If one code works to turn your TV on and off but does not change channels, you can try other codes to find one that provides more complete TV control.*

---

4. Turn on the TV and your 3•2•1 system.
5. On the 3•2•1 remote, press and hold the TV button for several seconds.



Wait until the red light at the top of the remote turns on.

6. Use the number buttons on this remote to enter the device code for your TV.

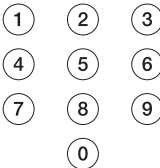

The light turns off briefly as you press each key.

7. Make sure the light turns off completely after all digits are entered.

If the light blinks now, the code is invalid. Return to step 5 and try a different code for your TV.

8. Point the 3•2•1 remote at your TV and press the TV On/Off button.

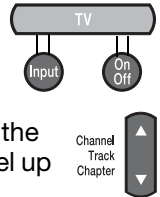

Use the 3•2•1 remote to turn the TV on again and change channels, using the number buttons or by pressing Channel up or down.

If it performs both operations, this code is correct. Write the code numbers below:

If this code does not work, repeat steps 5-8 using a different code for your TV.

---

**Note:** *For a CD changer or combination CD/DVD player and changer, your brand may not be listed in the CD/DVD device codes on page A-21. In some cases, the same brand of DVD or VCR device codes can work with a changer.*

---

## SETUP

## Controlling another component

With your CBL•SAT, VCR, or other component turned on, follow these steps.

1. In the Device Codes list, find the codes for the type and brand of your component.

2. On the 3•2•1® remote, press and hold the button for this component for several seconds.



Wait until the red light at the top of the remote turns on.

3. Enter the device code for your component.

The light turns off briefly as you press each key.

4. Make sure the light turns off completely after all digits are entered.

If the light blinks instead of turning off, the code is invalid. Return to step 2 and try a different code for your component.

5. Point the 3•2•1 remote at your component and press the On/Off button for this source.

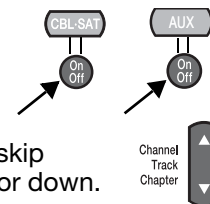

Use the 3•2•1 remote to turn the component on again and to skip forward by pressing channel up or down.

If it performs both operations, this code is correct. Write the code numbers below:

If this code does not work, repeat steps 2-5 using a different code for your component.

## Trying out the DVD

When you first turn on the system, you can play the provided DVD to get a step-by-step review of your setup.

1. Before you continue, make sure that:
  - All of the cables needed for your setup are connected.
  - Batteries are installed in the 3•2•1® system remote control.
  - The system power cord is plugged in at both ends.
2. Turn on your TV.
  - Use the TV On/Off button on the 3•2•1 remote if you have it set up to control your TV.
  - Or use the remote control that came with the TV.
3. Play the provided DVD.
  - a. Point the 3•2•1 remote control at the media center and press CD/DVD.

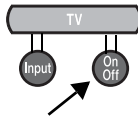

- b. On the media center controls, press Eject.
- c. Insert the disc into the disc tray.
- d. Press Eject again to close the tray and begin automatic play.
- e. If the DVD does not begin playing, press the play button on the remote.

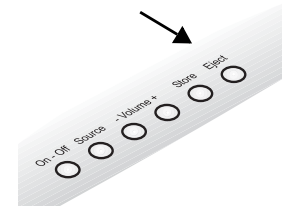

Playing the DVD helps verify that your system setup is correct.

**Note:** If you do not see the DVD video on your TV screen, change the Video Input on the TV.

Use the TV Input button on the 3•2•1 remote if you have it set up to control your TV.

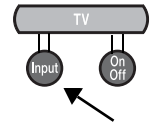

Or use the button for Video Input on your TV remote control. For more information, refer to the owner's manual that came with your TV.

If you STILL do not see the DVD image on your screen, see the problem identified as "Sound, but no picture" under Troubleshooting on page 62.

## CONTROLS AND INDICATORS

### The remote control

Aim the 3•2•1® remote control at the media center or at the component you are controlling with the remote.

1. Press the white On/Off button near the top of the remote control.

The system turns on to the last used source\*, which may be:

- CD•DVD
- FM•AM
- TV
- CBL•SAT
- AUX

If your media center does not respond to the remote:

- Make sure there is nothing blocking the front display where signals are received.
- Aim more directly at the media center.
- Move closer to the system.  
The control range of the remote is roughly 20 feet (6.2 meters).

*\*If your 3•2•1 system is connected by Bose® link cable to a Lifestyle® system in another room, your Lifestyle® system could be the selected source.*

2. Get to know how the remote works:
  - See the brief descriptions on pages 35-38.
  - Try out the various buttons to see how they work.



## Power and source buttons



Turns the 3•2•1® system on and off.  
Play begins with the source last used.



Silences or restores the sound.



Selects the built-in CD/DVD player as source and turns on the system.



Selects the built-in FM/AM radio as source and turns on the system to the station last used.

Switches between FM and AM when the radio is playing.

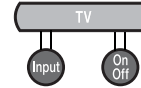



Selects audio from the TV source and turns your 3•2•1 system on if it was off.

If the remote is set up control your TV:

- Input selects a TV Video Input.
- On/Off turns the TV on and off.

Your remote also provides one of the two buttons shown here:

- For adjusting the on-screen aspect ratio of video from cable, satellite, or TV (but not DVD). 
- For displaying teletext information that is provided with broadcast programs (in Europe only). 



Selects the audio from the device connected to CBL•SAT on the media center rear panel.

Turns your 3•2•1 system on if it was off.

If the remote is set up to control this source, On/Off turns the cable or satellite box on and off.



Selects the audio from the device connected to AUX on the media center rear panel.

Turns your 3•2•1 system on if it was off.

If the remote is set up to control this source, On/Off turns the AUX device on and off.

## CONTROLS AND INDICATORS

## Menu and movement buttons



Settings

Enters the Settings menu for the source that is playing.



System

Enters the System main menu.



DVD Menu

Displays the DVD menu for the current disc on your TV screen.



Guide

Displays an on-screen program guide for any connected video devices that provide a guide.



Exit

Exits the 3•2•1® Settings or System menu.  
Exits the on-screen menus or information screens of other connected video sources.



Page

Moves ahead or back by one page in an electronic program guide, if one is available.

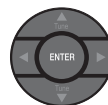

Confirms the selection of a menu item.



Moves up, down, left, or right in a menu or screen.

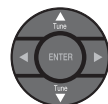

Tunes the FM/AM radio up or down to the next frequency.

Selects the next or previous item in a menu list.



Volume

Raises or lowers the volume.

- Pressing + raises the volume and unmutes the system (if muted).
- Pressing – lowers the volume.

Channel  
Track  
Chapter

Skips backward or forward to the next:

- TV, cable, or satellite channel
- CD track
- DVD chapter



## Play and numeric buttons



Halts play of recorded music or video.



Pauses or resumes paused play of recorded music or video.



Starts or resumes play of recorded music or video.



**For CD or MP3:** Moves to the previous or next track.

- Press and hold scans through a track.

**For DVD and DVR:** Moves backward or forward in video.

- More presses increase the speed.

**For FM/AM:** Moves to the previous or next strong radio station.



**For CD:** Randomly plays the music.

- Pressing again ends random play.

**For DVR:** Moves backwards a few seconds with each press.



**For CD or MP3:** Repeats the current track.

- Pressing again repeats the disc.
- Pressing three times ends the repeat.

**For DVR:** Moves forward a few seconds with each press.



**For CD:** Selects a track.

**For DVD:** Selects a chapter.



**For TV, cable, or satellite:** Selects the channel of the numbers pressed.



**For FM/AM:** Selects a preset radio station.



Info

**For CBL•SAT:** Displays or dismisses an on-screen information window (if one is available).

**For MP3:** Holding down the button displays or dismisses artist and title information on the media center display panel.



Previous





**For TV, cable, or satellite:** Returns to the channel last selected.

## CONTROLS AND INDICATORS

---





### Record and A, B, C buttons (not in Europe)

These buttons can be used with a DVR, VCR, a cable box, or satellite box. This requires that the 3•2•1® remote is set to control the component.

-  Starts DVR or VCR recording of the cable, satellite, or TV program that is playing.
-  Makes a selection from a cable on-screen List A.
-  Makes a selection from a cable on-screen List B.
-  Makes a selection from a cable on-screen List C.

### Colored buttons (in Europe only)

These buttons can be used with Teletext, a cable box, or a satellite box (if the 3•2•1 remote is set to control the box).

-  Red – Selects the screen content labeled red.
-  Green – Selects the screen content labeled green.
-  Yellow – Selects the screen content labeled yellow.
-  Blue – Selects the screen content labeled blue.

## The media center

The front of the media center features:

### Control buttons

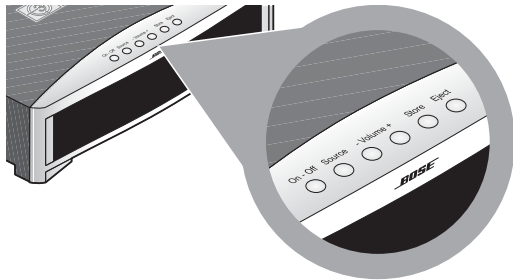

On•Off	Turns the system power on or off.
Source	Displays and sets the choice of play options.
- Volume -	Lowest or raises the volume level.
Enter	Selects the next available radio preset.
Eject	Opens or closes the disc tray.

**Note:** When you use the Source button on the media center to select a connected component for play, your 3•2•1® remote will not control that component. Press the CBL•SAT or AUX button on the remote to control that source.

### Display

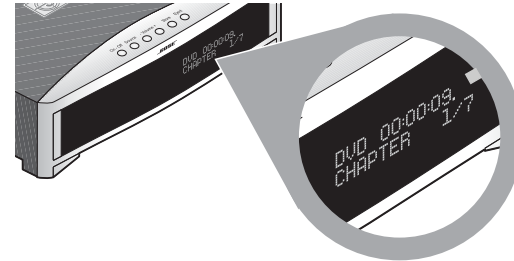

When the system is turned on, the display shows:

- selected source (CD/DVD, for example)
- source status (stopped, for example)
- source data (elapsed DVD time, for example)
- system status (like disc tray OPEN, shown below)

### Disc tray

Use the Eject button to open and close this tray. Do NOT push the tray to close it.

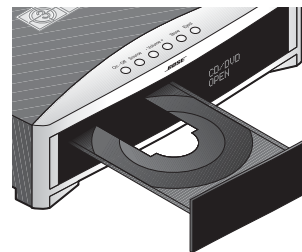

## OPERATION

### Playing a video disc or CD

1. Press CD•DVD on the 3•2•1® remote.

This turns on the 3•2•1 system and selects the CD/DVD source.

For video play, also turn on the TV.

You may need to change the TV Video Input to see the correct video.

---

**Note:** To prevent mid-play video disc problems, be sure the disc is clean. This is particularly important with rented DVDs.

---

2. On the media center control panel, press Eject to open the disc tray.
3. Place the disc (right side up) in the tray.
4. Press Eject again to close the tray.

The disc begins to play automatically.

If not, press Play on the 3•2•1 remote.

The media center display registers disc information and progress as the play continues.

---

**Note:** If the display text is not in your language, see “Language choices” on page 48.

---



---

**Note:** There are several ways to select a TV Video Input:

- If your 3•2•1 remote is set to work with your TV, press the TV Input button.
- If the remote is not set to work with your TV, use the Input button on your TV remote control. Or see your TV owner’s guide for instructions.

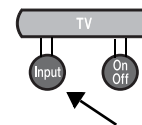

### Selecting a play option

If you want to:

**Interrupt play**, press Pause on the remote control.



- To resume playing a paused disc, press Pause again. Or press Play.



**Halt play**, press Stop.



- To resume playing a stopped disc, press Play.
- To restart the disc at the beginning, press Stop once more and then press Play.



**Skip to the next CD track or DVD chapter**, press Chapter up.



**Skip to the previous CD track or DVD chapter**, press Chapter down.

**Replay** part of the disc, press Repeat.

- Press once to replay the CD track or DVD chapter.
- Press twice to replay a CD disc or DVD title.
- Press three times to end the replay.



**Scan backward** or **forward** through the disc, press and hold Seek reverse or Seek ahead.



Press Play to end the scan.



**Stop** a disc and **open** the disc tray, press Eject on the media center.

## Keeping your discs clean

Scratches or dirt on a disc can prevent it from playing properly.

To avoid this problem:

- Handle discs by their edges to prevent fingerprints and scratches. Return them to their cases after use.
- Avoid exposing discs to:
  - chemical products that can cause damage.
  - writing directly on the disc or on a label attached to the disc.
  - direct sunlight, high temperatures, and humidity
- Use a soft, dry and lint-free cloth to clean the disc. Wipe straight out from the center to the edge.

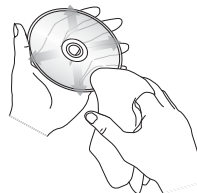



Do not use  
a circular  
motion



## OPERATION

## Checking for disc compatibility

If you have trouble playing a disc, check to be sure it is one of the compatible types below.

- Video DVD 
- Video CD 
- DVD-R, DVD-RW
- Audio CD 
- CD-R
- SACDs (CD-compatible content only)
- MP3 CDs:
  - burned in a single closed session
  - in disc format ISO9660
  - with .mp3 as the extension and no other periods in the file name.

### Region codes

For any DVD player and DVD disc to work together, the code for the region where they were sold must match. A code symbol is marked clearly on the bottom of your system media center and on the DVD cover (where it may be very small). For example, Region 1 is .

### Copy protection

Music and other content may be protected by international and domestic copyright laws and may contain specific restrictions on use and/or reproduction. Please respect the rights of the artists and other copyright holders.

## For DVDs: Setting Parental Control

You can password protect some DVDs that are not appropriate for other family members.

### Choosing a password

1. Turn on your TV and your 3•2•1® system.
  - Be sure to select the same TV Video Input that you use to watch a DVD.
2. Press the System button on your 3•2•1 remote control.
  - The System menu appears on screen.
3. Press the right arrow button to select the DVD Lock icon .
4. Press ENTER.
5. Use the number buttons to create your four-digit password.

### Setting a restriction level

1. Choose a Parental Control Setting from the chart of ratings defined by the Motion Picture Association of America (MPAA).

#### Ratings supplied by the MPAA

Parental Control Setting	MPAA Rating	Audience Restriction
8		None
7	NC-17	Adult audiences
6	R	Mature audiences
5		Mature teenage audiences
4	PG-13	Teenage audiences
3	PG	Mature young audiences
2		Most audiences
1	G	General

The numbers above the one you select will be restricted.

2. In the System menu, select DVD Lock and enter your password.
3. Use the arrow buttons to reach Lock UnRated Discs and select Yes.
4. Move down to Lock Discs Rated Above and right to the numbers.
5. Press the up or down arrow button to select a number.  
Any numbers above this selection will be restricted by password protection.
6. Press ENTER to save this setting and Exit to move out of the System menu.

## Playing a cable box or other component

1. Press the button for the source (CBL•SAT or AUX) you want to play.

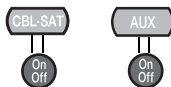

This turns on the 3•2•1® system to the selected source.

2. Turn on your component and, if it is a video source, turn on the TV.

If the 3•2•1 remote is set to control the component, you can press the source On/Off button on the remote.

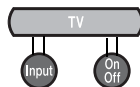

3. Choose the proper Video Input on your TV if the source is a video component.

## Adjusting for audio delay

While playing a DVD, you may notice that the picture and audio are not in perfect sync. For example, you see a person's lips move after you hear the words.

To make small adjustments to this timing, use the audio delay setting on the 3•2•1 system:

1. Press the Settings button on the 3•2•1 remote control.  
The Settings menu appears on screen.
2. Move down to the audio delay icon  and press ENTER.
3. Select an adjustment (1-8) and wait to see if this corrects the problem.  
Each selection makes a minute timing adjustment. It may be difficult to notice the change.



## Getting digital audio from a source

For an Optical digital audio connection to the media center, the connected component must be recognized by the system.

Currently, the system is set to recognize CBL•SAT as the Optical component.

If the Optical connection is for a different component:

1. Display the 3•2•1® system menu on the TV by pressing System.
2. Move right to the Media Center icon  and press ENTER.
3. Move down to Optical Source and press ENTER.
4. Move up or down to select a component from the list and press ENTER.
5. Press Exit to leave the System menu.

---

**Note:** When using your 3•2•1 system with the TV, turn the volume on your TV set all the way down. This prevents an echo effect from two sets of speakers playing.

---

## Choosing other options

The 3•2•1 system provides optional settings and adjustments to meet your specific needs.

For example you can:

- Set a countdown time for the system to turn off automatically.
- Choose another language for text on the media center display and in system menus.
- Adjust the bass or treble audio compensation.
- Change the image format on your TV screen.

---

**Note:** Your TV may provide an on-screen menu to make changes to the video image.

---

For a full list and description of these options, see “Adjustments to the performance” on page 47.

## OPERATION

## Listening to the radio

Your 3•2•1® system includes an FM and AM radio.

1. On the 3•2•1 remote, press FM•AM.



This turns on the 3•2•1 system and plays the radio station last selected.

2. Press the FM•AM button to switch between FM and AM.

3. Press the Channel up or down buttons to tune from one station to another.



To tune to:

- A preset station, press the Preset number button.
- The next clear station, press a Seek button.

### Creating a preset

You can assign a preset number for 20 FM and 20 AM stations. Then, by pressing the preset number, you tune immediately to the particular station:

1. Tune to the station you want to assign to a preset.
2. Choose the number you want to assign to that station.

3. Press and hold the chosen number button:
  - For numbers 1 through 9, press and hold the button.

PRESET:x\* SET appears briefly on the media center display.

- For numbers 10 through 20, press the first number, then press and hold the second number.

PRESET:xx\* SET appears briefly on the display.

### Removing a station from a preset

1. Press the number of the preset.
2. Listen to be sure this is the preset you want to erase.
3. Press and hold zero.

PRESET:xx\* ERASED appears briefly on the display.

*\*x represents the number you select.*

## ADJUSTMENTS TO THE PERFORMANCE

---

### Changing system features

---

If your system operates as you want it to, you may not need any changes.

Some kinds of setup, however, require a change for optimal performance. In most cases, you make a System change just once.

The features that you can change include:

- Audio
- Video
- Media Center
- DVD Lock

Using the DVD Lock feature is described in “Playing a video disc or CD” on page 40.

For details on the other options available, refer to the tables on the pages that follow.

### To get to the System menu

The System menu appears on your TV screen only.

1. Turn on your 3•2•1® system.
2. Turn on your TV and select the TV Video Input that you use to watch a DVD.
3. Press the System button on your 3•2•1 remote.  
The System menu appears on your TV screen.
4. To get into the menu, move right and select an icon (like Media Center, shown on page 48) for one of the system features.  
The list of options appears on the menu screen.

---

**Note:** *Entering the System menu pauses a DVD or CD.*

---

## ADJUSTMENTS TO THE PERFORMANCE

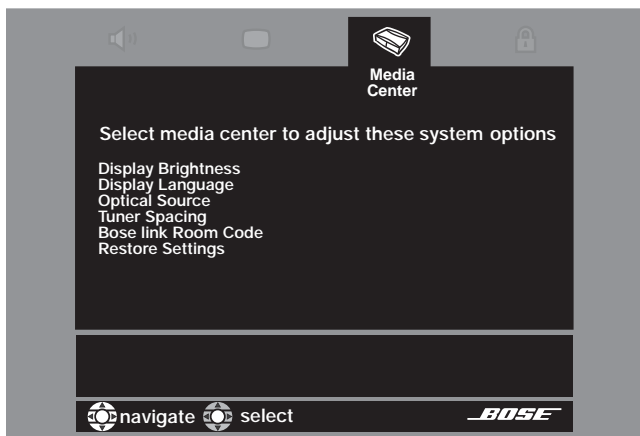

### Selecting a new option

1. Make sure you see the System menu on your TV screen.
2. Move right to select the system feature you want to change and press ENTER.
3. Press the up and down buttons to move to the option you want.  
As explanation for each options appears at the bottom of the menu when you highlight the option by moving up or down.
4. Press ENTER to select the option.
5. Change the option by selecting a new setting (or by pressing number buttons, as needed).
6. Press Exit to leave the System menu.

### Language choices

You can select the language you prefer to see on-screen and on the media center display. To make this change, move to the Display Language option in the Media Center feature of the System menu.



## Audio options

These options affect the way the system sounds in your home.

Option	Default Setting (Options)	Description
Bass Compensation	0 (-14 to +14)	Zero is for standard low-tone performance. – decreases and + increases these low tones.
Treble Compensation	0 (-14 to +14)	Zero is for standard high-tone performance. – decreases and + increases these high tones.
Audio Processing	Automatic (User Adjustable)	Keeps Bose® processing as the standard. Allows some processing options (Movie EQ, Range Compression, Mono Decoding) to appear in Settings menus.
Input Levels: TV Analog Input Level TV Digital Input Level CBL•SAT Analog Input Level CBL•SAT Digital Input Level AUX Analog Input Level AUX Digital Input Level	Normal (-6, -3, +3, +6)	Decreases or increases the volume level setting for the input of a connected component.  This minimizes abrupt volume changes when you switch from DVD or FM•AM audio on the Bose media center to audio from a connected component.  <b>Note:</b> To match AM and FM levels, which can vary depending on the program or station, adjusting the volume on your audio component may be preferable.
DVD Audio <i>(Only for TVs connected to the media center by HDMI cable.)</i>	Bose 3•2•1 (TV Stereo)	Plays the DVD audio from 3•2•1® media center over the 3•2•1 speakers. Sends two channels of DVD audio by HDMI cable to the TV and plays this sound on the TV speakers as well as on the Bose® speakers.

## ADJUSTMENTS TO THE PERFORMANCE

## Video options

These options affect the way the picture looks on your TV.

Option	Default Setting (Options)	Description
<p>Widescreen TV</p> <p><b>Note:</b> If your TV is connected using an HDMI cable, you may not see a choice of settings.</p>	<p>Yes (16:9) (No 4:3)</p>	<p>Yes tells the system that widescreen (16:9) is the TV format.</p> <p>No tells the system that 4:3 is the TV format.</p> <p>For a TV connected using a Composite, S-Video, or Component cable, selecting No also makes available the DVD Image option (below).</p> <p><b>Note:</b> If you are not sure what type of cable is used to connect your TV, check the Video Connector indicator, which is explained on page 51.</p>
<p>DVD Image</p> <p><b>Note:</b> This option is NOT available UNLESS you have selected No in the Widescreen TV option (above) for your TV connected using a Composite, S-Video, or Component cable (not HDMI).</p>	<p>Modified (Original)</p>	<p><u>For a TV connected using an HDMI cable:</u></p> <p>Modified allows the Bose® system to automatically provide the resolution that is preferred for your TV (usually 720 or 1080), so the image fills the screen. You can change this video resolution in the Settings menu.</p> <p>Original tells the Bose® system to keep the image in the original DVD format (in 480 or 576 resolution), regardless of how it fills the screen. No change can be made to this video resolution in the Settings menu.</p> <p>(Some TVs determine automatically how to fill the screen, overriding any choice.)</p> <p><u>For a TV connected using non-HDMI cable:</u></p> <p>Modified allows the Bose system to adjust the images on some <u>widescreen</u> DVDs to fill a 4:3 TV screen. This is done by removing the black bars on top and bottom and by cropping the sides of the image. (Many DVD images, even widescreen, will still appear with black bars on top and bottom.)</p> <p>Original tells the Bose system to keep the image in the original format of the DVD. A <u>widescreen</u> DVD image will have black bars on top and bottom.</p>

Option	Default Setting (Options)	Description
Video Connector <i>(Only an indicator.)</i>	(HDMI) (Composite + S-Video) (Component)	Identifies the type of video connection made on the back panel of the media center. This is not an adjustable setting.
Video Black Level <i>(Appears on screen only if the TV connects to the media center using a Composite or S-Video cable.)</i>	Normal (Extended)	Screen black level generally appropriate for most TVs. Darkens the intensity of the black on screen.
TV Video Format	NTSC - US (PAL - EUROPE) (MULTISTANDARD)	Correct for NTSC (U.S. standard) monitors. Correct for PAL (European standard) monitors. Only for a TV that supports multiple formats (NTSC and PAL).
Progressive Scan <i>(Appears on screen only if the TV connects to the media center using a Component cable. It is not needed with HDMI.)</i>	Off (On)  <b>Note:</b> <i>If selecting On distorts your screen, press the remote up arrow to reselect Off.</i>	Screen image repaints in standard style. Screen image repaints in advanced style (if your TV provides this option).  <b>Note:</b> <i>With an HDMI connection, you will not see the On option. The HDMI cable automatically senses your TV capabilities and applies progressive scan as appropriate.</i>

## ADJUSTMENTS TO THE PERFORMANCE



## Media center options

These options affect general operation of the system.

Option	Default Setting (Options)	Description
Display Brightness	4 (1 to 4)	Media center display shows text at its brightest. Choosing a lower number darkens text on the display.
Display Language	English (Dansk, Deutsch, Español, Français, Italiano, Nederlands, Svenska)	On-screen display menus appear in the selected language.
Optical Source	CBL•SAT  (TV, AUX)	Set for a component connected by Optical cable to the CBL•SAT AUDIO IN on the 3•2•1® media center. Identifies a different component connected by Optical cable to the media center.
Tuner Spacing	US  (European)	Applies the regional standard for incremental spacing between AM and FM stations.
Bose Link Room Code	B  (C, D, E, F, G, H, I, J, K, L, M, N, or O)	Links the 3•2•1 system to a unique code so it works with Bose® link as a second room sound source. Bose link expansion is a Lifestyle® system feature.
Restore Settings	No  (Yes)	Maintains your established changes in the Settings menu. Returns all of your selections in the Settings menu to the original factory settings.



## Choosing new settings

You can use the 3•2•1® Settings menus for quick adjustments while you watch a video or listen to music.

For example, if you want to change the screen resolution for DVDs, you will find that option in the TV Settings menu.

To see these options, enter the Settings menu for the selected source. Symbols and definitions for the options that are offered appear on screen.

---

**Note:** *Some of the settings made while you are playing a particular source are temporary. When you change sources or turn off the system, these settings revert to the factory selections.*

---



## To get to the Settings menu



1. Use the 3•2•1 remote to select the audio or video source that you want to change.
2. Press the Settings button.  
The Settings menu that affects this source appears on your media center display.  
It also appears on screen if your TV is on and you select the proper TV Video Input.
3. Move up or down to the option you want and press ENTER.
4. Move right to select a new setting for that option and press ENTER.
5. Press Exit to leave the Settings menu.

The Settings menu appears as a vertical bar of icons. To familiarize yourself with the icons, see “Settings options” on pages 54-59.







## ADJUSTMENTS TO THE PERFORMANCE



## Settings options

	Features	Default Setting (Options)	Effect
	<p>Audio Delay</p> <p><i>Available only for DVDs and connected video components.</i></p>	<p>0</p> <p>(0, 1, 2, 3, 4, 5, 6, 7, 8)</p>	<p>Each number change adjusts the delay by about 30 milliseconds.</p> <p>The most noticeable mismatch in the video and audio synchronization (caused by the video processing in some TVs), occurs in scenes with people talking.</p> <p>If they appear to finish sentences before their lips stop moving, select a different Audio Delay setting to correct this condition.</p>
	<p>Movie EQ</p> <p><i>Available only if Audio Processing is set to Adjustable in the Audio System menu. (Not available for CD or FM-AM.)</i></p>	<p>Off</p> <p>(On)</p>	<p>Leaves the equalization of the movie soundtrack as originally recorded.</p> <p>Adjusts the equalization of the movie soundtrack to better suit some home theater installations.</p> <p><b>Note:</b> To turn on Movie EQ, the Audio Processing option in the System menu must be set as User Adjustable.</p>
	<p>Range Compression</p> <p><i>Available only if Audio Processing is set to Adjustable in the Audio System menu. (Not available for CD or FM-AM.)</i></p>	<p>Off</p> <p>(On)</p>	<p>Leaves the volume range of the movie soundtrack as originally recorded.</p> <p>Reduces the volume range of sounds on a movie soundtrack.</p> <p>Late at night or at other quiet times, the startling difference between the quietest and loudest audio passages in a movie can be a problem. Turning this feature On moderates those effects.</p> <p><b>Note:</b> To turn on Range Compression, the Audio Processing option in the System menu must be set as User Adjustable.</p>



	Features	Default Setting (Options)	Effect
	<p>Mono Decoding</p> <p><i>Available only if Audio Processing is set to Adjustable in the Audio System menu. (Not available on CD or FM-AM.)</i></p>	<p>Off</p> <p>(On)</p>	<p>When one-channel (mono) is the audio input, this mono signal is sent to both speakers.</p> <p>Processes the signal from one-channel (mono) audio input (if it is detected) for right and left channel output.</p>
	<p>Audio 1 + 1</p> <p><i>Available only if a dual mono signal is detected on a video CD or digital broadcast.</i></p>	<p>1</p> <p>(2, Both)</p>	<p>Allows you to decode and play bilingual audio from a VCD or single-channel digital broadcast.</p> <p>When the digital audio content is on two channels, each channel carries a unique mono soundtrack (1 + 1).</p> <p>Changing this setting allows you to hear the audio on mono channel 2, or both mono channels at the same time.</p>
	<p>Video Resolution</p> <p><i>Adjustable only for a TV connected by HDMI AND only if the DVD Image setting in the System menu is Modified.</i></p>	<p>_____ * Default</p> <p>(1080p, 1080i, 720p, 480/576p, 480/576i)</p>	<p>Your 3•2•1® system sets its DVD video resolution to match the default that is communicated to it by the TV. You can experiment with other settings to see which one provides the best picture.</p> <p>HDTVs can accept different resolutions as input, and in some cases the highest number does not result in the best picture.</p> <p><b>Important note:</b> When you change resolution, your TV screen takes several seconds to make the transition. Allow for this adjustment before pressing other buttons.</p>

## ADJUSTMENTS TO THE PERFORMANCE

	Features	Default Setting (Options)	Effect
	Time <i>(For DVD only.)</i>	_: _ (0:00)	Changing the elapsed time moves to a different point in the DVD.
	Title <i>(For DVD only.)</i>	_ of _	Changing the first number moves to a different title on the current disc. Some DVDs do not allow direct access to titles.
	Chapter <i>(For DVD only.)</i>	_	Changing this number moves to a different chapter on the current disc. Some DVDs do not allow direct access to chapters.
	Audio Track <i>(For DVD only.)</i>	Dependent on disc	Gives you a choice of audio tracks on the current disc.
	Subtitle Language <i>(For DVD only.)</i>	Dependent on disc	Gives you a choice of subtitle languages (if several are included on the disc).
	Camera Angle <i>(For DVD only.)</i>	1 of _	Gives you a choice of camera angles (if several are included on the disc).

	Features	Default Setting (Options)	Effect
	A-B Repeat <i>(For DVD only.)</i>	A, B	Repeats a segment of the DVD after the start and end points are defined. To begin: <ol style="list-style-type: none"> <li>1. Move backward or forward to the point in the DVD where you want the segment to start.</li> <li>2. Press ENTER.</li> <li>3. Move to the point where you want it to end.</li> <li>4. Press ENTER.</li> </ol> Repeats until you select this setting option again and press ENTER.
	Track <i>(For CD only.)</i>	__ of __	Changing this first number moves to a different track on the current disc.

## ADJUSTMENTS TO THE PERFORMANCE

	Features	Default Setting (Options)	Effect
	Sleep Timer	Off (10-90)	Setting countdown minutes causes your 3•2•1® system to turn off when the time reaches 0. The choices, from 10 to 90 minutes, are divided into 10-minute increments. To cancel the timer, select Off.
	Output Mode <i>(For FM only.)</i>	Auto (Mono-Stereo)	Allows you to choose stereo or monaural (mono) audio performance by selecting: <ul style="list-style-type: none"> <li>• Auto – The FM tuner will automatically play in stereo if that is available. Otherwise, it will play in mono (single channel).</li> <li>• Mono – The FM tuner will always play in mono.</li> <li>• Stereo – The FM tuner will always play in stereo if available. Otherwise, it plays mono.</li> </ul> When you change the tuner frequency, the setting resets to Auto.
	RDS Info <i>(For FM and only on some systems.)</i>	On (Off)	Displays any station and program information that is available from the Radio Data System.

## Replacing remote batteries

Replace both batteries when the remote control stops operating or its range seems reduced. Alkaline batteries are recommended.

1. Slide open the battery compartment cover on the back of the remote.

2. Remove both batteries.

Be sure to dispose of the batteries according to the regulations in your area.

3. Insert two AA (IEC-R6) 1.5V batteries, or the equivalent. Match the + and – symbols on the batteries with the + and – markings inside the compartment.
4. Slide the battery compartment cover back into place.

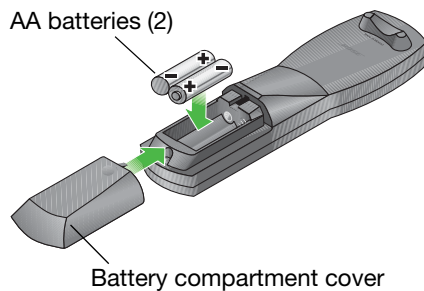

## Protecting the system

Follow the guidelines below for keeping the system in good working order.

- Do not allow liquids to spill into any openings.
- Do not use any solvents, chemicals, or cleaning solutions containing alcohol, ammonia, or abrasives.
- Do not use any sprays near the system.

### Cleaning the media center

Use only a soft, dry cloth to clean the outside surfaces of the media center.

### Cleaning the speakers

Use a soft, damp cloth. Or use an ammonia-free window cleaner on a soft cloth to maintain the finish.

## REFERENCE

## Troubleshooting

System issues	What to do
System doesn't turn on	<ul style="list-style-type: none"> <li>• Make sure the Acoustimass® module power cord is inserted securely into the AC (mains) power outlet and into the power connector on the Acoustimass module.</li> <li>• Be sure to press a source button (CD•DVD, CBL•SAT, etc.) on the 3•2•1® remote.</li> <li>• Unplug the power cord for 60 seconds, then plug it in again. This allows the unit to reset itself after a power surge or power interruption.</li> <li>• For a 230-240V system (used typically in Europe), make sure the power switch on the Acoustimass module is turned on ( I ).</li> <li>• For a dual voltage 3•2•1 system only, make sure the voltage setting is correct for your region. If it is set to 115V, the system may not operate in a 230V region.</li> </ul> <p><i><b>CAUTION:</b> Do not change the voltage switch from 230V to 115V unless you are certain it is appropriate for the power supply in your location.</i></p>
No sound	<ul style="list-style-type: none"> <li>• Increase the volume.</li> <li>• Check to see if MUTE is lit on the display. If it is, press the Mute button on the remote control to unmute the sound.</li> <li>• Be sure that you have pressed the correct source button (CD•DVD, CBL•SAT, etc.) on the 3•2•1 remote.</li> <li>• Check the audio connections for the component you want to play.</li> <li>• Connect the FM and AM antennas.</li> <li>• Make sure that the cable between the Acoustimass module and the media center is connected securely.</li> <li>• Check connections between the speakers and the Acoustimass module.</li> <li>• Turn off the media center for 60 seconds, then on again, to restore communication between the media center and the speakers.</li> </ul>
Sound is distorted	<ul style="list-style-type: none"> <li>• Make sure speaker cables are not damaged and the connections are secure.</li> <li>• Reduce the volume level on the external device playing through the 3•2•1 system speakers.</li> </ul>
Sound is marred by a loud hum or buzz	<ul style="list-style-type: none"> <li>• Try plugging your system into a different AC outlet.</li> <li>• Check to see if your media center and its audio input cable are within 3 ft (1 m) of any other electronic or electrical device. Some examples are a TV, cable box, VCR, wireless internet router, dimmer switches, blinking lights, or microwaves.</li> <li>• Move the media center farther away and notice if the humming still occurs.</li> </ul>



System issues	What to do
No sound from TV only	<ul style="list-style-type: none"> <li>• If your TV has Variable instead of Fixed audio output, you need to turn off the TV speakers internally. Refer to your TV owner's guide and follow the instructions provided there.</li> </ul>
Speech and lip movement on screen are not in sync	<ul style="list-style-type: none"> <li>• Adjust the Audio Delay using the Settings menu on screen. For details, refer to "Choosing new settings" on page 53.</li> </ul>
Radio does not work or has poor reception	<ul style="list-style-type: none"> <li>• Make sure the antennas are connected and positioned as shown in "Installing the FM and AM radio antennas" on page 25.</li> <li>• Adjust the FM antenna position to reduce interference.</li> <li>• Move antennas farther from the media center, TV, or other electronic equipment.</li> <li>• Select another station. You may be in an area of weak signal coverage for some stations.</li> </ul>
Volume level changes when another sound source is selected	<ul style="list-style-type: none"> <li>• Change the Audio Level for the source input so its volume matches the volume of the radio and DVD in the Bose® system. Refer to "Audio options" on page 49.</li> </ul>
Remote issues	What to do
3•2•1® remote does not control your TV, CBL•SAT, or AUX component	<ul style="list-style-type: none"> <li>• Make sure that the remote is set to control the component. Refer to "Setting the remote for your TV" on page 31.</li> <li>• Make sure that the front of the component is not obstructed.</li> <li>• Reset the remote using a different device code for the component you want to control. Refer to "Device codes" located at the back of the book. There may be several codes that can turn the component on and off, but only one that provides further control (channel changing, for example).</li> </ul>
3•2•1 remote behaves erratically or does not work	<ul style="list-style-type: none"> <li>• Aim the remote at the front of the media center.</li> <li>• Make sure the battery polarity (+ and -) matches the polarity marked in the battery compartment.</li> <li>• Install new batteries. Refer to "Replacing remote batteries" on page 59.</li> </ul>

## REFERENCE

Video issues	What to do
Sound, but no picture	<ul style="list-style-type: none"> <li>• Make sure the TV is on.</li> <li>• Make sure the TV is set to the correct Video Input to see the video from DVDs on the Bose® system.</li> <li>• Make sure a DVD is in the disc tray.</li> <li>• If the TV is connected to the media center using the HDMI cable: <ul style="list-style-type: none"> <li>– Switch from one Video Input to another and then back to the original input.</li> <li>– Turn everything off, then: <ul style="list-style-type: none"> <li>A. Turn on the TV and set the TV Video Input for the Bose system video.</li> <li>B. Turn on the 3•2•1® system and press DVD.</li> </ul> </li> <li>– Turn off both the TV and the 3•2•1 system and then: <ul style="list-style-type: none"> <li>A. Unplug the HDMI cable from both ends.</li> <li>B. Disconnect the power cables from both your TV and the 3•2•1 Acoustimass® module.</li> <li>C. Re-connect power to the television and to the Acoustimass module.</li> <li>D. When the 3•2•1 startup message disappears from the display, re-connect the HDMI cable.</li> <li>E. Turn on the TV first, then turn on the 3•2•1 system.</li> </ul> </li> <li>– Disconnect the HDMI cable that connects the TV to the 3•2•1 media center. Reconnect the two using a Component cable, an S-Video cable, or the Composite cable provided with the system.</li> </ul> </li> </ul>
Incorrect picture for the selected source	<ul style="list-style-type: none"> <li>• Make sure the TV is set to the correct Video Input.</li> </ul>
Picture is black and white, flickers, gets dark, or rolls	<ul style="list-style-type: none"> <li>• Check the video cable connections.</li> <li>• If the media center is connected to the TV using a Component cable, make sure the colored cable plugs (red, green, and blue) match the connector colors on the media center and on the TV.</li> <li>• Check the Video Format setting (NTSC or PAL) and change it. Refer to “Video options” on page 50.</li> </ul>
Picture is not clear or is unstable	<ul style="list-style-type: none"> <li>• Use the Settings menu to lower the output resolution of the system. Your 3•2•1 system sets its DVD video resolution to match the default that is communicated to it by the TV. You can experiment with other settings to see which one provides the best picture.</li> </ul> <p>HDTVs can accept different resolutions as input, and in some cases the highest number does not result in the best picture.</p>

Disc issues	What to do
DVD or CD does not play  <i>Note: If you are using the HDMI cable between the TV and media center, there are other possible solutions in "Sound, but no picture" on the previous page.</i>	<ul style="list-style-type: none"> <li>• Make sure the Acoustimass® module power cord is inserted securely into the AC (mains) power outlet and into the power connector on the Acoustimass module.</li> <li>• Check to see if the Play symbol in the display is lit.</li> <li>• After pressing the CD•DVD button, wait a few seconds and press Play.</li> <li>• Make sure the disc is properly inserted (label-side up).</li> <li>• Eject the disc and try loading it again.</li> <li>• Clean the disc to remove fingerprints, dust, or dirt. Refer to "Keeping your discs clean" on page 41.</li> <li>• Try another disc. Some discs are defective and will not play.</li> <li>• Make sure the disc is compatible with the media center disc player. Also make sure the region codes match. Refer to "Checking for disc compatibility" on page 42.</li> </ul>
Disc won't eject	<ul style="list-style-type: none"> <li>• Follow these steps:               <ol style="list-style-type: none"> <li>1. Turn off the unit.</li> <li>2. Unplug the Acoustimass module power cord from the outlet for 60 seconds, then reconnect it. This allows the unit to reset itself.</li> <li>3. Before powering on, press and hold Eject on the media center.</li> </ol> </li> </ul>
Lock DVD password lost	<ul style="list-style-type: none"> <li>• Enter the password 2673 to gain entry to the Lock DVD screen.</li> </ul>

## For customer service

For additional help in solving problems, contact Bose® Customer Service. Refer to the address sheet included in the carton.

## Limited warranty

This system is covered by a transferable limited warranty. Details of the limited warranty are provided on the *Product Registration Card* that came with your system.

## REFERENCE

## Technical information

---

### Power rating

USA/Canada: 120V~ 60Hz 300W

International: 220-240V~ 50/60Hz 300W

Dual voltage: 115/230V~ 50/60Hz 300W

### Antennas

**FM** 75Ω – external FM antenna

**AM** – external AM antenna

### Maximum ambient temperature

104°F (40°C)

### Dimensions

Media center: 3¼"H x 13¾"W x 10"D  
(8.3 cm x 34.9 cm x 25.4 cm)

Remote control: 1⅞"H x 2½"W x 9"D  
(3.0 cm x 6.5 cm x 22.9 cm)

Speakers: 2½"H x 5½"W x 4"D  
(6.4 cm x 14 cm x 10.5 cm)

Acoustimass® module: 14½"H x 8¾"W x 19⅞"D  
(36.7 cm x 22.2 cm x 48.5 cm)

### Weights

Media center: 6.7 lb (3.0 kg)

Speakers: 1 lb (.45 kg) each

Acoustimass module: 23.3 lb (10.6 kg)

### Finish

Media center: polymer

Speakers: polymer

Acoustimass module: polymer

**4:3** – See “Aspect ratio.”

**16:9** – See “Aspect ratio.”

**A Analog audio** – The sounds that we hear with our ears, unlike digital audio that is encoded as bits of information.

**Aspect ratio** – An expression for the width of the picture relative to the height. For example, if the aspect ratio is 4:3 (considered a normal screen), the shape of that picture is 4 units wide by 3 units high. The standard TV aspect ratios are 4:3 and 16:9 (called widescreen).

4:3 screen



16:9 screen

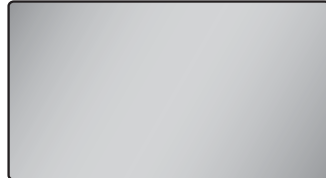

**C CD** – The abbreviation for a compact disc that stores digitally encoded music that is read by the laser beam in a compact disc player. This provides high-quality playback.

**Chapter** – A main division of contents in a DVD title.

**Coaxial cable** – Can carry digital audio signals between a source device and the 3•2•1® system.

**Component video** – Also called YPbPr for its three-part video signals that include luminance and two color signals. Component video requires the use of a Component cable. This provides considerably better resolution than is possible from either Composite or S-Video signals.

**Composite video** – The simplest of video signals, which combines black and white with color information. Its low- resolution signal is compatible with the broadest range of televisions and other video components and requires a simple RCA video cable.

## GLOSSARY

**D Digital audio** – Audio in digital form, which is encoded as bits of information.

**Dolby Digital** – A means of encoding multi-channel audio, developed by Dolby Laboratories and accepted as an international standard.

 – The logo representing Dolby Digital.

**DTS** – An abbreviation for Digital Theater Systems. DTS encoding provides a type of multi-channel surround sound format used on certain CDs and many DVDs.

 – The logo representing DTS.

**DVD** – An abbreviation most commonly known to mean digital video disc or digital versatile disc. A DVD looks like a CD but contains high-quality video and multi-channel audio for movies.

**DVD-R, DVD-RW** – Abbreviations for Recordable (R) and ReWriteable (RW) Digital Video (or Versatile) Disc (DVD). Data can be added to a DVD-R once only, and to a DVD-RW more than once.

**DVD-ROM** – The abbreviation for Read Only Memory (ROM) on a Digital Video (or Versatile) Disc (DVD), which allows no data to be added.

**DVD video** – A standard for storing and reproducing audio and video on DVD-ROM discs, based on MPEG video, Dolby Digital audio, and other proprietary data formats.

**DVR** – An abbreviation for Digital Video Recording (otherwise known as PVR for Personal Video Recording). With a hard drive, an electronic program guide, and internal processing, a DVR simplifies recording and playback of programs.

**H HDCP** – An abbreviation for High-bandwidth Digital Content Protection. HDCP is a form of Digital Rights Management licensed by Digital Content Protection, LLC, to control digital audio and video content as it travels across Digital Visual Interface (DVI) or High-Definition Multimedia Interface (HDMI) connections. (It prevents unauthorized copying of programs.)

**HDMI** – An abbreviation for High-Definition Multimedia Interface. HDMI is a de-facto standard interface that delivers clear, all-digital audio and video via a single cable.

**HDTV** – An abbreviation for High-Definition TV, a digital television format that delivers sharper picture quality with more lines of resolution. HDTV offers a much better picture quality than standard television.

**I IR** – An abbreviation for infrared. Pertains to the type of remote that sends/receives commands on an infrared light beam.

**L Letterbox** – A video format that has an aspect ratio wider than 4:3 (refer to Aspect ratio) and is shown with black bars above and below the picture.

**M MP3** – This is a compressed audio format (MPEG-1 Layer III) that allows the recording of many hours of music on a single CD.

**MPEG** – An abbreviation for Moving Picture Experts Group, the committee of experts from the audio, video, and computer industries involved in setting standards for compression of moving images.

**N NTSC** – An abbreviation for National Television System Committee and the label for its video format standard used for televisions in the U.S. and other countries.

**O Optical cable** – Carries digital audio via optical fiber between a source device and your 3•2•1® system.

**P PAL** – An acronym for the Phase Alternate Line video format used extensively in Western Europe.

**PCM** – An abbreviation for Pulse Code Modulation. A common form of digital audio signal.

**Progressive scan** – A video format that displays all lines of the picture frame in a single pass and refreshes the TV image 30 times per second. Not compatible with all video displays.

**PVR** – Refer to DVR.

**R RDS** – A system that displays radio broadcast station and programming information. This feature is available on European systems only.

**Resolution** – The sharpness of a video image, signal, or display, generally described either in terms of lines of resolution or pixels.

GLOSSARY

---

**S SCART** – A type of connector commonly found on consumer electronics products manufactured for use in Western Europe.

**Screen ratio** – See Aspect ratio.

**Source** – Any device that provides audio or video signals for use with the 3•2•1® system. The AUDIO OUT from such a device connects to the AUDIO IN on the media center

**S-Video** – A video signal that separates the black and white from the color information. S-Video provides higher resolution than Composite video, but not as high as Component video. This type of connection requires use of an S-Video cable.

**T Teletext** – An information retrieval service provided by television broadcast companies in Europe and some other countries, not including the U.S.

**Title** – A main component of contents on a DVD. There can be several titles on a DVD, one of which may be a movie.

**V Video CD** – A compact disc (CD) that contains video.

**W Widescreen** – A TV having an aspect ratio of 16:9 with a picture shape that is 16 units wide by 9 units high. (Refer to Aspect ratio.)

**Y YPbPr** – See Component video.



©2008 Bose Corporation. No part of this work may be reproduced, modified, distributed, or otherwise used without prior written permission.

The distinctive design of the 3•2•1® media center is also a registered trademark of Bose Corporation.

Manufactured under license from Dolby Laboratories. "Dolby" and the double-D symbol are trademarks of Dolby Laboratories. Confidential Unpublished Works. ©1992-1997 Dolby Laboratories. All rights reserved.

This product contains one or more programs protected under international and U.S. copyright laws as unpublished works. They are confidential and proprietary to Dolby Laboratories. Their reproduction or disclosure, in whole or in part, or the production of derivative works therefrom without the express permission of Dolby Laboratories is prohibited. ©1992-1996 by Dolby Laboratories, Inc. All rights reserved.

MPEG Layer-3 audio compression technology licensed by Fraunhofer IIS and THOMSON multimedia.



Manufactured under license under U.S. Patent #'s: 5,451,942; 5,956,674; 5,974,380; 5,978,762; 6,487,535 & other U.S. and worldwide patents

issued & pending. DTS and DTS Digital Surround are registered trademarks and the DTS logos and Symbol are trademarks of DTS, Inc. ©1996-2007 DTS, Inc. All Rights Reserved.

This product incorporates copyright protection technology that is protected by method claims of certain U.S. patents and other intellectual property rights owned by Macrovision Corporation and other rights owners. Use of this copyright protection technology must be authorized by Macrovision Corporation, and is intended for home and other limited viewing uses only unless otherwise authorized by Macrovision Corporation. Reverse engineering or disassembly is prohibited.

Consumers should note that not all high definition television sets are fully compatible with this product and may cause artifacts to be displayed in the picture. In case of 525 or 625 progressive scan picture problems, it is recommended that the user switch the connection to the "standard definition" output. If there are ques-

tions regarding your TV set compatibility with this model 525p and 625p DVD player, please contact our customer service center.

Designed with UEI Technology™ Under License from Universal Electronics Inc. ©UEI 2000-2002.

This product incorporates copyright protected technology and other intellectual property rights owned by Cirrus Logic, Inc. and subject to the copyright protection of the U.S. as well as other licensing restrictions and protections. Use of this copyright protected technology is limited solely to use with the Cirrus Logic integrated circuits incorporated in this product. Reverse engineering or disassembly is prohibited.

The Simplay™ logo and the 'Simplay™,' and 'Simplay Labs™,' trademarks are owned by Silicon Images, Inc. and are used under license from Silicon Images, Inc. and/or Simplay Labs, LLC.

HDMI, the HDMI logo and High-Definition Multimedia Interface are trademarks or registered trademarks of HDMI Licensing, LLC.

# DEVICE CODES

---

---

**TV** ..... **A-2**

**CBL** ..... **A-15**  
Cable box

**SAT** ..... **A-16**  
Satellite receiver

**CD/DVD** ..... **A-21**

**DVD** ..... **A-21**

**VCR** ..... **A-26**

**A-ACC** ..... **A-32**  
Audio accessory

**V-ACC** ..... **A-32**  
Video accessory

**R-ACC** ..... **A-32**  
Audio receiver

## TV

888 .....	0264, 0412	Aiwa.....	0264, 0032, 0701, 1180, 1904, 1911, 1916	Amplivision .....	0370, 0217	ART .....	1037
A-Mark .....	0047, 0054, 0003, 0009, 0020, 0032, 0039, 0165	Akai.....	0000, 0060, 0812, 0702, 0178, 0030, 0145, 0556, 0037, 0548, 0714, 0606, 0361, 0264, 0218, 0433, 0696, 0729, 0745, 0753, 1935, 0826, 1259, 1537, 1675, 1676, 1903, 0672, 0648, 0602, 0480, 0473, 0412, 0371, 0217, 0208, 0163, 0151, 0056, 0038, 0035, 0009	Ampro .....	0751	Arthur Martin ....	0163
A.R. Systems ...	0556, 0037, 0455, 0352, 0374	Akashi .....	0009, 0860	Amstrad .....	0000, 0171, 0037, 1037, 0264, 0218, 0433, 0163, 0039, 0177, 0033, 0011, 0362, 0371, 0412, 0648, 0009, 1982	ASA .....	0070, 0105
Abex.....	0032	Akiba .....	0037, 0218, 0455, 0282	Amtron .....	0000, 0180, 0019	Asberg .....	0037
Accent .....	0037, 0009	Akira .....	0418	Anam .....	0250, 0180, 0037, 0003, 0009, 0628, 0700	Asora .....	0009
Accuscan .....	0047, 0018, 0135	Akito .....	0037	Anam National .	0250, 0037, 0650, 0055	Astar .....	1531, 1548
Acec.....	0012	Akura .....	0171, 0037, 0714, 0668, 1037, 0264, 0218, 0009, 0163, 0282, 0412, 1498, 1556, 1982	Andersson .....	1149, 1163	Astra .....	0037
Acer.....	1339	Alaron .....	0170, 0179	Anglo .....	0264, 0009	Asuka .....	0264, 0218, 0217, 0282
Acoustic Research	1269	Alba .....	0037, 0714, 0668, 1037, 0487, 0370, 0218, 0036, 1935, 0474, 0443, 0418, 0371, 0163, 0038, 0032, 0009	Anhua .....	0051	ATD.....	0698
Action .....	0030, 0650, 0003, 0019, 0052, 0185	Alfide .....	0672	Anitech.....	0037, 0264, 0009, 0282, 0474	Atlantic .....	0037
Acura .....	0009	All-Tel.....	0865, 1269	Ansonic.....	0037, 0668, 0370, 0009, 0012, 0163, 0374, 0411	Atori .....	0009
Addison.....	0653, 0108, 0092, 1150	Alleron .....	0030, 0170	AOC .....	0451, 0093, 0180, 0060, 0178, 0030, 0108, 1365, 1150, 1089, 0628, 0474, 0185, 0179, 0157, 0092, 0052, 0039, 0038, 0032, 0019, 0018, 0009, 0003	Auchan .....	0163
ADL .....	1217	Allorgan .....	0217	Aolimpike .....	0264, 0412	Audinac .....	0180
Admiral.....	0047, 0054, 0017, 0051, 0093, 0463, 0180, 0264, 0016, 0018, 0019, 0163, 0165, 0179, 0418	Ambassador ....	0150, 0177	Apex Digital.....	0156, 0748, 0765, 0185, 0767, 0879, 0890, 1217, 1943	Audio-Technica	0019
Advantz .....	0282	American Action	0180	Apollo .....	0473	Audiosonic .....	0037, 0714, 0486, 0264, 0370, 0218, 0009, 0109, 0217, 0374, 0820, 1308
Advent .....	0761, 0783, 0815, 0817, 0842, 1933	American High..	0000, 0060	AR .....	0556, 0352	Audioton.....	0486, 0264, 0370, 0217
Adventura .....	0046			Arc En Ciel.....	0109	Audiovox .....	1564, 0451, 0180, 0003, 0092, 0179, 0623, 0802, 0875, 1937
Adventuri .....	0000			Arcam .....	0217	Aumark .....	0060
Adyson .....	0032, 0217			Archer .....	0003	Autovox.....	0217, 0247, 0544
AEG .....	1163, 1556			Ardem .....	0037, 0714	Aventura .....	0171
Agashi .....	0264, 0217			Aristocrat .....	0163	AVP .....	0000
Agna.....	0150			Aristona.....	0556, 0037, 0012	Awa .....	0451, 0606, 0264, 0036, 0108, 0009, 0011, 0157, 0217, 0374, 1376
Aiko.....	0037, 0361, 0264, 0433, 0009, 0035, 0092, 0217, 0371					Axion .....	1937
Aim.....	0706, 0037, 0455, 0753					Axxent .....	0009
						Axxon .....	0714
						Baihe .....	0264, 0009, 0412
						Baile .....	0009, 0374, 0661

Baird .....	0037, 0109, 0179, 0208, 0217, 0343, 1196	Black Diamond .	1909, 1037, 0614, 0753, 0820, 1163		0355, 0335, 0282, 0217, 0208, 0163, 0009	Changfei .....	0009, 0374, 0817
Bang & Olufsen	0565, 0619, 1620	Black Star .....	0247	Byd:sign .....	1309, 1311	Changfeng .....	0264, 0412, 0696, 0753, 0817
Baohuashi .....	0264, 0412	Blackway .....	0218, 0282	C-Tech .....	0891, 0896	Changhai .....	0009, 0817
Baosheng .....	0009, 0817	Blaupunkt .....	0195, 0036, 0455, 0170, 0200, 0327, 0535, 0554	Caihong .....	0009, 0817	Changhong .....	0156, 0765, 0264, 0508, 0009, 0767, 0783, 0817, 0820, 1156
Barco .....	0556, 0163	Blue Sky .....	0556, 0037, 0714, 0668, 1037, 0487, 0218, 0455, 0282, 0499, 1254, 1314, 1363, 1916	Cailing .....	0748	Chengdu .....	0009, 0817
Basic Line .....	0556, 0037, 0668, 1037, 0218, 0455, 0009, 0163, 0217, 0282, 0339, 0374, 1163	Blue Star .....	0282	Candle .....	0030, 0039, 0046, 0056, 0186	Ching Tai .....	0003, 0009, 0092, 0179, 0474
Bastide .....	0217	Bondstec .....	0247	Canton .....	0218	Chun Yun .....	0000, 0180, 0003, 0009, 0033, 0092, 0179, 0474, 0700, 0843, 1150
Baur .....	0037, 0195, 0361, 0455, 0146, 0512, 0535, 0544, 0554	Boots .....	0009, 0217	Capehart .....	0017, 0178, 0030, 0036, 0003, 0019, 0032, 0046, 00052, 0092	Chunfeng .....	0264, 0009
Baycrest .....	0032, 0046, 0186	Boxlight .....	0893	Capetronic .....	0030, 0003	Chung Hsin .....	0180, 0053, 0036, 0108, 0033, 0474, 1150
Baysonic .....	0236, 0463, 0180	BPL .....	0037, 0208, 0282, 0896	Capsonic .....	0264	Chungfeng .....	0412
Bazin .....	0217	Bradford .....	0180	Carad .....	0668, 1037, 0610	Chunsun .....	0009, 0817
Beaumark .....	0017, 0178, 0030, 0019, 0179	Brandt .....	0625, 0714, 0560, 0109, 0287, 0335	Carena .....	0037, 0455	Cimline .....	0218, 0009
Beijing .....	0812, 0264, 0226, 0009, 0208, 0374, 0412, 0661, 0817	Brick .....	0039	Carnivale .....	0030	Cinema .....	0672
Beko .....	0037, 0714, 0195, 1037, 0486, 0606, 0370, 0418, 0808	Brinkmann .....	0037, 0668, 0486, 0418, 0519	Carrefour .....	0037, 0036, 0070	Cineral .....	0451, 0092
Belcor .....	0030, 0019	Briovega .....	0037, 0362	Carver .....	0054, 0170	Cinex .....	0648, 1556
Bell & Howell ...	0054, 0017, 0154, 0093, 0016, 0179	Britannia .....	0217	Cascade .....	0037, 0009	Citek .....	0047, 0032
Belson .....	0698	Brockwood .....	0178, 0030, 0019, 0056	Casio .....	0037	Citizen .....	0054, 0000, 0451, 0463, 0180, 0060, 0030, 0171, 1935, 1928, 0535, 0003, 0016, 0282, 0280, 0186, 0019, 0092, 0020, 0056, 0046, 0039, 0035, 0032
Belstar .....	1037	Broksonic .....	0236, 0463, 0180, 0003, 0039, 0177, 1911, 1929, 1935, 1938	Cathay .....	0037, 0218, 0032, 0474	City .....	0009
BenQ .....	1032, 1315, 1562, 1756	Brother .....	0264	CCE .....	0037, 0217	Civet .....	0185
Beon .....	0037, 0218, 0032, 0039, 0163, 0418	BSR .....	0163	Celebrity .....	0000	Clairtone .....	0185
Berthen .....	0668	BTC .....	0218	Celera .....	0765	Clarion .....	0180
Best .....	0370	Bush .....	0556, 0037, 0714, 0668, 1037, 0698, 0487, 0361, 0264, 0218, 0036, 1259, 1556, 1900, 0661, 0660, 1954, 0614, 0519, 0374, 0371,	Celestial .....	0767, 0820	Clarivox .....	0037, 0070, 0418
Bestar .....	0037, 0370, 0374			Centrex .....	0706, 0780, 0826, 0891	Classic .....	0030, 0019, 0056, 0092, 0499
Bestar-Daewoo	0374			Centrum .....	1037		
Binatone .....	0217			Centurion .....	0037		
				Century .....	0247		
				CGE .....	0370, 0074, 0163, 0247, 0418		
				Changcheng ...	0051, 0264, 0009, 0374, 0412, 0661, 0817		

Clatronic .....	0037, 0714, 0264, 0370, 0218, 0009, 0217, 0247, 0371	Curtis Mathes ...	0047, 0054, 0154, 0000, 0051, 0451, 0093, 0180, 0060, 0702, 0178, 0030, 0145, 0166, 0037, 0179, 0466, 1147, 1347, 1919, 0056, 0044, 0039, 0038, 0035, 0032, 0019, 0018, 0016	0019, 0032, 0039, 0056, 0092, 0374	Dream Vision ....	1704	
Clayton.....	1037	CXC .....	0180	Dayu.....	0374, 0661	Drean .....	0037
CMS Hightec....	0217	Cybertron .....	0218	De Graaf.....	0548, 0044, 0163, 0208	DSE .....	0698, 0820, 1556
Colortyme .....	0047, 0054, 0017, 0060, 0178, 0030, 0018, 0019, 0032	Cytron .....	1326	DEC.....	0891	DTS .....	0009
Colt .....	0019	Cytronix .....	1298	Decca .....	0037, 0033, 0217	Dual .....	0037, 1037, 1137, 0217, 0343, 0352, 0394, 0519, 0544
Commercial Sols	0047, 1447	D-Vision .....	0556, 0037, 1982	Degraff .....	0163, 0208	Dual Tec .....	0217
Concerto .....	0056	Daenyx .....	0180, 0179, 0672	Deitron .....	0374	Dumont .....	0017, 0180, 0178, 0016, 0019, 0032, 0070, 0217
Concorde .....	0009	Daewoo .....	0154, 0451, 0180, 0178, 0030, 1661, 0556, 0037, 0634, 1909, 0264, 0218, 0036, 0108, 1928, 0661, 0672, 0700, 1902, 0860, 0865, 1756, 1755, 0880, 1150, 1307, 1598, 0003, 0009, 0019, 0020, 0032, 0039, 0056, 0092, 0109, 0170, 0217, 0374, 0474, 0499, 0623, 0627, 0628	Dell.....	1080, 1178, 1264	Durabrand .....	0463, 0180, 0178, 0171, 0003, 1034, 1463
Condor .....	0037, 0264, 0370, 0009, 0247, 0282, 0411, 0418	Dainichi.....	0218	Delphi .....	0829	Dux .....	0037, 0012
Conia .....	0754, 0820, 1498	Dansai .....	0037, 0036, 0009, 0032, 0035, 0208, 0217	Delta .....	1369	DVX .....	0891
Conic .....	0178, 0032	Dansette .....	0412	Denko .....	0264	Dwin .....	0093, 0720, 0774
Conrac .....	0808	Dantax .....	0714, 0486, 0370	Denon .....	0145, 0038, 0055, 0511, 0576	Dynatech .....	0217
Conrowa.....	0156, 0145, 0698, 0264, 0009, 0412, 0696, 0753, 1156	Datsura.....	0208	Denstar .....	0628	Dynatron.....	0037, 0012
Contec .....	0180, 0037, 0036, 0009, 0157, 0185	Dawa .....	0037, 0009	Denver .....	0037, 0587, 1189	Easy Living .....	1248
Continental Ed.	0487, 0109, 0287	Daytek .....	0672, 1376	Desmet .....	0037, 0009	Eaton .....	0060
Cosmel .....	0037, 0009	Dayton .....	0009, 0092	Dewo.....	0628	Ecco .....	0773
Craig .....	0180, 0171, 0179, 0282	Daytron.....	0180, 0178, 0030, 0037, 0036, 0009,	Diamant .....	0037	ECE .....	0037
Crosley .....	0054, 0000, 0180, 0030, 0171, 0370, 0074, 0096, 00163, 0187, 0247	DL .....	0587, 0780, 0872, 0891	Diamond .....	0706, 0698, 0009, 0371, 0672, 0820, 0825, 0860, 0896	Edison-Minerva	0487
Crown .....	0093, 0180, 0053, 0037, 0714, 1037, 0486, 0487, 0606, 0712, 0370, 0412, 0418, 0339, 0208, 0672, 00056, 0039, 0009	Domeos .....	0668	Dick Smith Elec.	0698, 1556	Elbe .....	0037, 0610, 0218, 0217, 0362, 0411
Crown Mustang	0672	Domland .....	0394	Digatron .....	0037	Elcit .....	0163, 0247
CS Electronics	0218, 0247	Dongda .....	0009	Digiline .....	0037, 0668, 0105	Electroband.....	0000, 0185
CTC.....	0247	Donghai .....	0009	Digital Life.....	0780, 0872, 0891	Electrograph....	1755
CTX .....	1756			Digitex.....	0820	Electrohome.....	0154, 0000, 0463, 0150, 0178, 0030, 0019, 0032, 0039, 0056, 0151, 0185, 0381

Elin .....	0037, 0548, 0361, 0009	Feilu .....	0009, 0817	Fujimaro .....	0865, 1498	General Tech. ...	0009
Elite .....	0037, 0218	Feiyue .....	0264, 0412	Fujitsu .....	0009, 0179, 0186, 0217, 0352, 0683, 0809, 0853, 1181	Genesis .....	0037, 0009
Elta .....	0264, 0009, 0474	Fenner .....	0009, 0817	Fujitsu General	0009, 0186, 0217, 0683	Genexxa .....	0037, 0218, 0009, 0163, 0412
Emco .....	0247	Fer0 .....	0009, 0374	Fujitsu Siemens	0808, 0809, 1163, 1298	Gericom.....	0808, 0865, 0880, 1217, 1298
Emerald.....	0178, 0177	Ferguson.....	0053, 0037, 0625, 0548, 0560, 0195, 1037, 0003, 0109, 0287, 0335, 0343, 0443, 1935	Funai .....	0000, 0180, 0171, 0668, 0264, 0039, 0179, 0342, 1271, 1904	Giant .....	0009, 0217
Emerson.....	0047, 0017, 0154, 0451, 0236, 0463, 0180, 0150, 0178, 0171, 0037, 0714, 0668, 0195, 1909, 0486, 0361, 0370, 0036, 0282, 0371, 0623, 1394, 1911, 1928, 1929, 0280, 0247, 0185, 0179, 0177, 0170, 0146, 0135, 0111, 0070, 0044, 0039, 0038, 0032, 0019, 0012	Fidelity .....	0171, 0037, 0361, 0264, 0163, 0217, 0371, 0412, 0423, 0474, 0512, 0544	Furi.....	0145, 0264, 0412, 0817	Gibraltar .....	0017, 0000, 0030, 0019
Emperor .....	0282	Filsai .....	0217	Furichi .....	0860	Gintai .....	0474, 1150
Envision.....	0030, 0019, 0032, 0039, 0813, 1365	Finlandia .....	0548, 0361, 0105, 0163, 0208, 0346	Futronic .....	0264, 0860	Go Video.....	0060, 0886
Enzer .....	0753, 0860	Finlux .....	0556, 0037, 0714, 0070, 0105, 0163, 0179, 0217, 0346, 0411, 0473, 0480, 0492, 0808, 1556	Futuretech.....	0180	Go Vision .....	1937
Epson .....	0833, 0840, 1290, 1322, 1122	Firstar .....	0236, 0009, 0033	Galaxi .....	0037	Goldfunk.....	0668
Erres .....	0037, 0012	Firstline .....	0556, 0037, 0714, 0668, 1037, 0361, 0009, 0208, 0217, 0247, 0374, 0411, 0544, 0808, 1363	Galaxis .....	0037, 0370	GoldStar .....	0047, 0054, 0154, 0178, 0030, 0037, 0714, 0606, 0361, 0036, 0455, 0247, 0474, 1150, 1154, 1378, 1926, 0217, 0163, 0109, 0056, 0044, 0039, 0032, 0019, 0018, 0009
ESA .....	0812, 0171	Fisher .....	0047, 0054, 0154, 0000, 0361, 0370, 0036, 0157, 0159, 0208, 0217, 0544	Ganxin .....	0817	Gooding.....	0487
ESC .....	0037, 0217, 0474	Flint .....	0037, 0610, 0264, 0218, 0455	Gateway.....	1755, 1756	Goodmans.....	1163, 0000, 0556, 0037, 0625, 0714, 0560, 0668, 0634, 1909, 1037, 0487, 0264, 0218, 0036, 0587, 0009, 1900, 1376, 1308, 1259, 0335, 0880, 0808, 0011, 0032, 0661, 0035, 0343, 0179, 0217, 0499, 0360, 0480, 0374, 0371
Ether .....	0030, 0003, 0009	Force .....	1149	GBC .....	0218, 0009, 0163, 0374	GE.....	0047, 0000, 0051, 0451, 0093, 0180, 0060, 0178, 0030, 1447, 1454, 0625, 0560, 1922, 1919, 1917, 11347, 1147, 0018, 0335, 0282, 0135, 0021, 0092, 0055, 0052, 0027, 0046, 0044, 0038, 0035
Etron .....	0009, 0163, 0820	Formenti .....	0037, 0163	GEC .....	0037, 0361, 0163, 0217	Geloso .....	0009, 0163, 0247, 0374
Eurofeel.....	0264, 0217	Fortress .....	0093	Gemini .....	0047	General .....	0109, 0186, 0287
Euroman.....	0037, 0264, 0370, 0217	Fraba .....	0037, 0370	General Elec. ...	0047, 0021, 0027, 0055		
Europa .....	0037	Friac .....	0037, 0610, 0370, 0009, 0499				
Europhon.....	0037, 0109, 0217	Frontech .....	0264, 0009, 0163, 0217, 0247, 0474				
Evesham .....	1248						
Evolution .....	1756						
Expert .....	0163						
Exquisit .....	0037, 0247						
Feilang.....	0009						

Gran Prix .....	0179, 0648		0394, 0499, 0519, 0544, 0661, 0808		0009, 0208, 0696, 0753, 0780, 0860, 1156, 1208, 1314,	Huanghe .....	0009, 0817				
Granada .....	0037, 0548, 0560, 0036, 0108, 0226, 0012, 0032, 0146, 0163, 0208, 0217, 0339, 0343, 0473	Hantarex.....	0037, 0009, 0829, 0865	Hitachi .....	1445, 0047, 0054, 0017, 0000, 0156, 0051, 0150, 0178, 0030, 1145, 0145, 1256, 0037, 0548, 0634, 1037, 1137, 0036, 0108, 0225, 0508, 0719, 0744, 0578, 0576, 0499, 0492, 0481, 0480, 0797, 0877, 1045, 1149, 1150, 1156, 1225, 1245, 1378, 1481, 1576, 1904, 0009, 0016, 0018, 0019, 0027, 0032, 0035, 0038, 0039, 0044, 0055, 0056, 0092, 0105, 0109, 0151, 0157, 0163, 0165, 0179, 0185, 0186, 0217, 0282, 0343, 0381, 0473, 0474					Huanglong .....	0009
Grandin .....	0037, 0714, 0668, 1037, 0610, 0218, 0455, 0009, 0163, 0282, 0374, 0865, 0880	Hantor .....	0037			Huangshan .....	0264, 0009, 0412, 0817				
Gronic .....	0217	Harley Davidson	0000, 0180, 0060, 0178, 0030, 0019, 0179, 1904			Huanyu .....	0264, 0217, 0374, 0817				
Grundig .....	0706, 0556, 0037, 0195, 0487, 0036, 0587, 1954, 1935, 1916, 1376, 1308, 0683, 0672, 0554, 0535, 0443, 0163, 0070, 0009	Harman/Kardon	0054			Huaqiang .....	0264, 0412				
Grundy .....	0180, 0195, 0179	Harsper .....	0865			Huari .....	0145, 0264, 0412				
Grunkel.....	1163	Harvard .....	0180			Hugoson .....	0890, 1217				
Grunpy .....	0180, 0179	Harwa .....	0773, 1196, 1269			Huodateji .....	0051				
H & B .....	0808	Harwood .....	0037, 0487, 0009, 0032, 0412			Hygashi.....	0217				
Haaz.....	0706	Hauppauge .....	0037			Hyper .....	0009, 0217, 0247				
Haier .....	0037, 0698, 0587, 0508, 0768, 0891, 0896, 1034	Havermy.....	0093			Hypersonic .....	0361				
Haihong.....	0009	HCM.....	0037, 0264, 0218, 0009, 0217, 0282, 0412, 0418			Hypson .....	0556, 0037, 0714, 0668, 1037, 0486, 0264, 0455, 0217, 0282				
Haiyan .....	0264, 0412, 0817	Heathkit.....	0017			Hyundai .....	0753, 0849, 0860, 0865, 1376, 1531, 1556, 1598				
Halifax .....	0264, 0217	Helios .....	0865			Iberia .....	0037				
Hallmark.....	0236, 0180, 0178, 0019, 0135, 0179, 0187	Hello Kitty.....	0451			ICE.....	0037, 0264, 0218, 0217, 0371				
Hampton .....	0217	Hema.....	0009, 0217			ICeS.....	0218				
Hanimex.....	0218	Hemmermann ..	0544	Hitachi Fujian ...	0150, 0108, 0860	IIsonic.....	1376				
Hankook.....	0180, 0178, 0030, 0019, 0056, 0628	Hewlett Pkd ....	1494, 1502, 1088, 1089, 1642	Hitec .....	0698	Iiyama .....	0877, 0890, 1217				
Hannspree .....	1348, 1351	Hicon .....	1467	Hitsu .....	0610, 0218, 0455, 0009	iLo.....	1603, 1684				
Hanseatic .....	0556, 0037, 0714, 0634, 0361, 0370, 0009, 0217, 0282,	Hifivox .....	0109	Hoehner .....	0714, 0865, 1163, 1556	Ima.....	0236, 0180, 0178, 0179				
		Highline .....	0037, 0264	Home Elec. ....	0606	Imperial.....	0037, 0370, 0074, 0247, 0418				
		Hikona .....	0218, 0474	Hongmei.....	0093, 0264, 0009, 0817	Imperial Crown	0264, 0009, 0374, 0412, 0661				
		Hikone .....	0218	Hongyan .....	0264, 0412, 0817	Indiana.....	0037				
		Himitsu .....	0180, 0628	Hornlyphon .....	0037, 0012	Infinity .....	0054				
		Hinari .....	0037, 0264, 0218, 0036, 0009, 0032, 0096, 0163, 0179, 0208, 0282, 0352, 0355, 0443	Hoshai .....	0218, 0455, 0282	Ingelen.....	0714, 0610, 0487, 0163				
		Hisawa .....	0714, 0610, 0218, 0455, 0282	HP .....	1088, 1089, 1494, 1502, 1642	Ingersol.....	0009				
		Hisense .....	1363, 0156, 0748, 0145, 0556, 0508,	Hua Tun .....	0009, 1150	Initial .....	1603				
				Huaafa .....	0145, 0009						
				Huanghaimei ....	0009						

Inno Hit.....	0218, 0009, 0217, 0247, 0282, 1163	JBL .....	0054	Kamp .....	0017, 0180, 0019, 0185, 0217	Kolin .....	0180, 0150, 0053, 0036, 0108, 0033, 0474, 1150, 1331
Innova .....	0037	JCB.....	0000	Kanghua.....	0896	Kolster .....	0037, 0218, 0247
Innovation .....	0519	JDV.....	1982	Kangli .....	0264, 0009, 0374, 0661, 0817	Kongque.....	0264, 0009, 0817
Innowert .....	0865, 1298	Jean.....	0156, 0051, 0236, 0036, 0003, 0009, 0092, 0179, 0474	Kangyi .....	0264, 0009, 0412	Konichi .....	0009
Inotech .....	0773, 0820	JEC .....	0035	Kapsch .....	0361, 0163	Konig .....	0037
Insignia.....	1564, 0171, 1204, 1326, 1517, 1641, 2002	Jensen .....	0761, 0815, 0817, 1933	Karcher .....	0714, 0610, 0606, 0264, 0370, 0282, 1556	Konka .....	0180, 0037, 0714, 0218, 0587, 0817, 0754, 0720, 0719, 0707, 0703, 0638, 0632, 0628, 0418, 0371, 0282, 0080
Inteq .....	0017, 0145	Jiahua .....	0051	Kathrein.....	0556	Kontakt.....	0487
Interbuy .....	0037, 0264, 0009, 0247	JiaLiCai.....	0264, 0009, 0412	Kawa .....	0371	Korpel .....	0037
Interfunk .....	0037, 0361, 0012, 0109, 0163, 0200, 0247, 0327, 0512	JIL.....	0030, 0019	Kawasho .....	0030, 0019, 0185	Korting.....	0370, 0039
Internal .....	0037, 1909	Jinfeng.....	0051, 0226, 0208, 0817	Kaypani .....	0052	Kosmos .....	0037
Intervision.....	0037, 0486, 0487, 0264, 0218, 0455, 0009, 0217, 0247, 0282, 0394, 0519	Jinque .....	0264, 0009, 0412, 0817	KB Aristocrat....	0163	Kost .....	1262
Irradio .....	0037, 0218, 0009, 0247, 0371	Jinta .....	0264, 0009, 0412	KDS.....	1498	Kotron .....	0412
IRT.....	0451, 1661, 0698, 0628	Jinxing .....	0054, 0156, 0145, 0556, 0037, 0698, 0264, 0009, 0817	KEC.....	0180, 0060	Koyoda .....	0009
Isukai .....	0037, 0218, 0455, 0282	JMB .....	0556, 0634, 0443, 0499	Ken Brown .....	0236, 0463	Kriesler .....	0012
ITC.....	0217	JNC.....	1964	Kendo .....	0037, 1037, 0610, 0370, 0247, 0362, 0411, 0519, 0648	KTV.....	0463, 0180, 0030, 0039, 0185, 0217, 0280
ITS.....	0037, 0264, 0218, 0282, 0371	Jocel .....	0712	Kenia .....	0030, 0019	Kuaile .....	0264, 0009, 0412
ITT .....	0548, 0610, 0361, 0163, 0179, 0208, 0339, 0346, 0473, 0480, 0544	Johnson.....	0455	Kenmore .....	0146	Kulun .....	0009
ITT Nokia .....	0180, 0548, 0195, 0610, 0606, 0361, 0070, 0163, 0179, 0208, 0339, 0346, 0473, 0480	Jubilee.....	0556	Kennedy.....	0163	Kunlun .....	0051, 0264, 0226, 0208, 0374, 0661, 0817
ITV.....	0037, 0264, 0247, 0374	Juhua .....	0264, 0412, 0817	Kennex .....	0668, 1037	Kyoshu .....	0032, 0412, 0418
IX.....	0877	Jutan .....	0030, 0019	Kenwood.....	0180, 0030, 0019	Kyoto .....	0032, 0163, 0217
Janeil .....	0046	JVC.....	1253, 0054, 0093, 0463, 0053, 0030, 0606, 0218, 0036, 0650, 0653, 0508, 0055, 0070, 0371, 0418, 0683, 0731, 1172, 1923	Khind .....	0706, 0896	L&S Electronic .	0714, 0808, 0865
		Kaige .....	0264, 0009, 0412, 0817	KIC .....	0217	Lark .....	0154, 0386
		Kaisui .....	0037, 0218, 0455, 0009, 0217, 0282	Kiota .....	0455, 0371	LaSAT .....	0486
		Kambrook.....	0217	Kioto .....	0054, 0706, 0556	Lavis .....	1037
				Kiton .....	0037, 0668	Leader .....	0009
				KLH .....	0156, 0180, 0765, 0767	Lecson .....	0037
				KLL.....	0037	Legend .....	0009
				Kloss .....	0030, 0024, 0046	Lemair .....	0032, 0411
				KMC .....	0003, 0032		
				Kneissel.....	0556, 0037, 0610, 0370, 0362, 0374, 0411, 0499		
				Kobra .....	1467		



Lenco .....	0037, 1037, 0587, 0374, 0474	Logix .....	0668, 0519	Magnavox .....	0047, 0054, 0154, 0000, 0250, 0051, 0180, 0060, 0030, 0171, 1454, 0706, 0037, 0036, 1931, 1904, 1755, 1525, 1365, 1254, 1198, 0802, 0780, 0729, 0386, 0282, 0011, 0187, 0186, 0019, 0179, 0020, 0111, 0096, 0092, 0024, 0035	Matsuiama.....	0587
Lenoir .....	0009	Longjiang .....	0264, 0412, 0817			Maxdorf .....	0773
Lesa .....	0247	Luker .....	1982			Maxent .....	0762, 1211, 1755, 1756, 1757
Lexsor .....	1196	Luma .....	1037, 0009, 0163, 0362, 0374, 0411			Maxim .....	1556, 1982
Leyco .....	0037, 0264	Lumatron .....	0556, 0037, 0361, 0264, 0163, 0217			MCE .....	0009
LG .....	1423, 0054, 1265, 0060, 0178, 0030, 0556, 0037, 0714, 0698, 0361, 0370, 0108, 1305, 1325, 1378, 1178, 1154, 0856, 0829, 1637, 1758, 0700, 1926, 0644, 0474, 0442, 0247, 0217, 0163, 0109, 0056, 0039, 0038, 0032, 0019, 0009, 0003	Lux May .....	0037, 0009			Meck .....	0698, 0891
Liesenk & Tter .	0037	Luxman .....	0056			Mediator .....	0556, 0037, 0012
Liesenkotter .....	0037, 0012, 0327	Luxor .....	0548, 1037, 0361, 0163, 0179, 0208, 0217, 0346, 0473, 0480, 1163			Medion .....	0556, 0037, 0714, 0668, 1037, 0698, 1137, 0512, 0808, 0880, 1248, 1900
Lifetec .....	0037, 0714, 0668, 1037, 1137, 0218, 0009, 0374, 0519, 0683	LXI .....	0047, 0054, 0017, 0154, 0000, 0156, 0051, 0093, 0060, 0053, 0178, 0030, 0171, 0166, 0037, 0036, 0135, 0146, 0159, 0165, 0179, 0208, 0280, 0096, 0056, 0055, 0016, 0018, 0039, 0038, 0035, 0032, 0024, 0021, 0020, 0019			Megapower .....	0700
Lihua .....	0817	M & S .....	0054			Megas .....	0610
Lloyd's .....	0236, 0180, 0030, 0009, 0032, 0039, 0056, 0179, 1904	M Electronic .....	0037, 0714, 0634, 0195, 0661, 0512, 0492, 0480, 0411, 0374, 0346, 0343, 0287, 0247, 0217, 0163, 0109, 0105, 0009			Megatron .....	0047, 0178, 0145, 0003, 0009, 0056, 0151
Lloytron .....	0032					MEI .....	1037, 0185
Local Chennai TV	0009					Meile .....	0264, 0412, 0817
Local India TV .	0264, 0009, 0208, 0371, 0602					Memorex .....	0154, 0250, 0463, 0180, 0150, 0060, 0178, 0030, 0037, 0195, 1037, 1926, 1911, 0877, 0179, 0165, 0056, 0039, 0035, 0032, 0016, 0009
Local Malaysia TV	0698					Manhattan .....	0037, 0668, 1037
Lodos .....	1037					Marqma .....	1467
Loewe .....	0693, 0037, 0370, 0136, 0512, 0633, 0790					Marantz .....	0054, 0030, 1454, 0556, 0037, 0412, 0704, 0854, 0855, 1154, 1398
Logik .....	0236, 0180, 0060, 1037, 0698, 0009, 0011, 0016, 0033, 0056, 0179, 0371, 0773, 0880, 1217					Mark .....	0037, 0714, 0009, 0217, 0374
		Macy .....	0039, 0046, 0186			Maruman .....	0627
		Madison .....	0037			Master's .....	0499
		MAG .....	1498			Mastro .....	0053, 0706, 0698, 0780
		Magnadyne .....	0054, 0024, 0163, 0187, 0247, 0544			Masuda .....	0037, 0264, 0218, 0009, 0217, 0371
		Magnasonic .....	0054, 0000, 0156, 0093, 0030, 0003, 0019, 0056, 0092, 0109, 0179, 1928			Matsui .....	1163, 0556, 0037, 0714, 0195, 1037, 0487, 0036, 0455, 0433, 1916, 0744, 0544, 0443, 0371, 0355, 0352, 0335, 0217, 0208, 0177, 0163, 0056, 0039, 0035, 0033, 0011, 0009
						Matsushita .....	0250, 0051, 0650

Microstar .....	0808	Multitech .....	0180, 0037, 0486, 0264, 0370, 0009, 0179, 0217, 0247	Neufunk.....	0556, 0037, 0714, 0610, 0218, 0009	Oceanic .....	0548, 0361, 0163, 0208, 0473
MicroTEK .....	0820, 0860			New Tech .....	0556, 0037, 0009, 0056, 0217, 0343	Odeon .....	0264
Midland .....	0047, 0017, 0051, 0018, 0019, 0032, 0039, 0056, 0135	Murphy .....	0032, 0039, 0163, 0474	New World .....	0218	Okano .....	0037, 0264, 0370, 0009
Mikomi .....	1037, 1149	Musikland .....	0218, 0247	Newave .....	0093, 0178, 0009, 0092, 1150	Olevia .....	1144, 1240, 1331, 1610
Minato .....	0556, 0037	Mx Onda.....	1498	Nextier.....	1598	Olidata .....	1376
Minerva .....	0195, 0487, 0108, 0070, 0535, 0554	Myryad .....	0556	Nicam .....	0544	Omega .....	0264
Minoka .....	0037, 0412	NAD .....	0156, 0178, 0166, 0037, 0361, 0019, 0056, 0866, 1156	Nikkai .....	0037, 0264, 0218, 0036, 0009, 0032, 0035, 0163, 0179, 0217	Omni.....	0748, 0698, 0780, 0826, 0872, 0891
Mintek .....	1603	Naiko .....	0037, 0606, 1982	Nikkei .....	0714	Onida .....	0053, 1253
Minutz .....	0021	Nakimura .....	0037, 0374	Nikko .....	0178, 0030, 0092	Onimax .....	0714
Mirror .....	1900	Nanbao .....	0264, 0009, 0412	Nikkodo.....	0178, 0030, 0092	Onking .....	0280
Mitsubishi.....	0150, 0868, 0154, 0250, 0093, 0236, 0180, 1250, 0178, 0030, 0556, 0037, 0195, 1037, 0036, 0108, 1171, 1150, 1182, 0836, 0817, 1917, 0535, 0512, 0474, 0381, 0179, 0056, 0033, 0019, 0011	Nansheng .....	0264, 0412, 0817	Nintaus.....	0891	Onwa .....	0180, 0218, 0433, 0371, 0602
Mivar .....	0217, 0609	Narita .....	1982	Nishi .....	0030, 0018	Opera .....	0037
Monaco .....	0009	NAT .....	0226	Noblex .....	0154, 0037, 0264, 0018, 0052	Optimus.....	0154, 0250, 0093, 0180, 0150, 0178, 0030, 0166, 0650, 0016, 0032, 0039, 0056, 0165
Monivision .....	0700, 0843	National .....	0051, 0226, 0508, 0055, 0208	Noblisko.....	0070	Optoma .....	0887, 1348
Morgan's .....	0037	NEC .....	1398, 0047, 0154, 0156, 0051, 0053, 0178, 0030, 0264, 0036, 0455, 0653, 0508, 0499, 0603, 0661, 0704, 0817, 0882, 1150, 1182, 1378, 1456, 1704, 0497, 0474, 0412, 0381, 0374, 0217, 0186, 0170, 0165, 0056, 0046, 0019, 0016, 0011, 0009	Nogamatic .....	0109	Orbit .....	0037
Motorola.....	0054, 0051, 0093, 0150, 0055	Neckermann .....	0556, 0037, 0370, 0200, 0247, 0327, 0411, 0418, 0554	Nokia .....	0180, 0548, 0610, 0606, 0361, 0163, 0179, 0208, 0339, 0346, 0374, 0473, 0480, 0492	Origo .....	0003
MTC .....	0180, 0060, 0030, 0370, 0011, 0019, 0032, 0039, 0056, 0092, 0185, 0282, 0512	NEI.....	0037, 0163, 0371	Norcent .....	0748, 0824, 1089, 1365, 1590	Orion .....	0443, 0017, 0236, 0463, 0180, 0178, 0556, 0037, 0714, 0264, 1954, 1929, 1916, 1911, 1463, 1196, 0880, 0544, 0474, 0443, 0412, 0355, 0179, 0177, 0019, 0011
MTEC .....	0032	Neovia .....	0865, 1376, 1964	Nordic .....	0217	Orline .....	0037, 0218
MTlogic .....	0714	Nesco .....	0179, 0247	Nordmende .....	0037, 0714, 0560, 0195, 0109, 0287, 0343, 0891	Ormond .....	0668, 1037
Mudan .....	0051, 0264, 0226, 0009, 0208, 0412, 0817	Netsat .....	0037	Normerel .....	0037	Osaki .....	0556, 0037, 0264, 0218, 0032, 0217, 0355, 0374, 0412, 0474
Multitec .....	0037, 0668, 1037, 0486, 1556	NetTV .....	0762, 1755	Nu-Tec .....	0698, 0455, 0820	Osio.....	0037
		Network .....	0032	Nyon.....	0000		



Quadral .....	0051, 0218		0165, 0157, 0135, 0092	Saba.....	0250, 0625, 0548, 0714, 0560, 0361, 0109, 0163, 0287, 0335, 0343, 0498	Sanky .....	0060, 0030, 0019, 0038, 0039, 0280
Qualcraft .....	0039	Realistic .....	0047, 0154, 0180, 0150, 0178, 0030, 0003, 0016, 0019, 0032, 0039, 0056, 0165	Sagem .....	0610, 0455, 0618, 0830	Sansei .....	0451, 0092
Quartz .....	0150, 0178, 0046	Recor .....	0037, 0418	Saige .....	0009, 0817	Sansui .....	0463, 0060, 0030, 0706, 0037, 0714, 0455, 1935, 1929, 1911, 1904, 1537, 1531, 0826, 0753, 0729, 0602, 0371, 0165, 0019
Quasar .....	0250, 0051, 0650, 0009, 0016, 0024, 0035, 0055, 0165, 0247, 0474, 0865, 1919	Rectiligne.....	0037	Saisho .....	0264, 0009, 0011, 0033, 0163, 0177, 0217, 0544	Santon .....	0009
Quelle .....	0037, 0668, 0195, 1037, 0361, 0554, 0544, 0535, 0512, 0327, 0247, 0200, 0109, 0074, 0070, 0032, 0011	Rediffusion.....	0548, 0361, 0036, 0163, 0346	Saivod .....	0037, 0668, 1037, 0712, 1163, 1556, 1982	Sanyo .....	0047, 0054, 0154, 0000, 0156, 0463, 0180, 0145, 0171, 0037, 0264, 0370, 0036, 0108, 0508, 0412, 0424, 0474, 0544, 0704, 0798, 0799, 0893, 1755, 1208, 1142, 1150, 1154, 1179, 0381, 0376, 0339, 0280, 0217, 0208, 0170, 0163, 0159, 0157, 0146, 0105, 0088, 0046, 0011, 0009
Questa .....	0036, 0032	Redstar .....	0037	Sakai .....	0163	Sanyong .....	0037
Questar .....	0036	Reflex .....	0037, 0668, 1037	Sakyno .....	0455	Sanyuan .....	0093, 0009, 0817
R-Line .....	0037	Relisys .....	0865, 0877, 0878, 1211, 1298	Salora .....	0548, 0361, 0163, 0208, 0480	Saville .....	0060
Rabbit .....	0047	Remotec .....	0250, 0093, 0145, 0171, 0037, 0376, 0424, 0509, 0627	Salsa .....	0335	SBR .....	0556, 0037, 0012
Radialva .....	0218, 0163	Reoc .....	0714	Salora .....	0335	Sceptre.....	0878, 1217, 1360, 1599
Radiola .....	0556, 0037, 0012, 0217	Revox .....	0037	Sampo .....	0047, 0154, 0093, 0178, 0030, 0171, 0036, 0650, 1756, 1755, 0762, 0700, 0474, 0092, 0052, 0039, 0032, 0009	Schaub Lorenz .	0548, 0714, 0486, 0606, 0361, 0374
Radiomarelli ....	0037, 0247	Rex .....	0264, 0163, 0247, 0411	Samsung.....	1249, 1619, 0060, 0054, 0017, 0154, 0156, 0093, 0047, 0812, 0702, 0178, 0030, 0556, 0037, 0264, 0370, 0036, 0587, 0618, 0226, 1060, 0817, 1150, 0814, 1235, 0774, 0766, 1312, 0718, 1584, 0644, 1630, 1903, 0009, 0019, 0032, 0035, 0039, 0055, 0056, 0090, 0092, 0163, 0179, 0208, 0217, 0362, 0371, 0474, 0519	Schneider .....	0556, 0037, 0714, 0668, 1037, 0361, 1137, 0218, 1982, 1904, 0648, 0544, 0519, 0394, 0371, 0352, 0343, 0247, 0217, 0163, 0070, 0012
RadioShack.....	0047, 0154, 0180, 0150, 0178, 0030, 0037, 0019, 0032, 0039, 0056, 0165, 1904	RFT .....	0037, 0264			Scimitsu.....	0019
Radiotone .....	0037, 0668, 1037, 0264, 0370, 0009, 0412, 0418, 0648	Rhapsody .....	0185			Scotch .....	0178
Rank.....	0070	Rinex .....	0773				
Rank Arena.....	0036, 0602, 0753	Road Authority .	0282				
RBM .....	0070	Roadstar .....	0037, 0714, 0668, 1037, 0264, 0218, 0009, 0282, 0418, 1189, 1900				
RCA.....	0047, 0054, 0000, 0051, 0093, 0060, 0178, 0030, 1447, 1454, 0625, 0560, 0618, 2002, 1922, 1919, 1917, 1547, 0018, 0019, 1347, 1247, 1147, 1047, 0774, 0753, 0679, 0021, 0038, 0090,	Rover .....	0036, 0877				
		Rowa .....	0748, 0037, 0698, 0712, 0264, 0587, 0009, 0817				
		Royal .....	0825				
		Royal Lux .....	0370, 0335, 0412				
		Runco .....	0017, 0060, 0030, 0016, 0497, 0603, 1398				
		Ruyi.....	0817				
				Samsux .....	0038, 0039		
				Sandra .....	0217		
				Sanjian .....	0264, 0412		

Scotland.....	0163	Sharp .....	1393, 0818, 0093, 1602, 0054, 0180, 0053, 0030, 0668, 0036, 0650, 0653, 1193, 0688, 0689, 0720, 0787, 0851, 1165, 1917, 0491, 0474, 0386, 0256, 0200, 0179, 0165, 0157, 0039, 0032, 0019, 0009	Silver .....	0361, 0036, 0455, 0019, 0179	Sonolor.....	0548, 0361, 0163, 0208, 0282
Scott .....	0236, 0180, 0178, 0030, 0019, 0039, 0177, 0179, 1189	Shen Ying .....	0003, 0009, 0092, 0179, 0474	SilverCrest .....	1037	Sontec .....	0037, 0370, 0009
Sears .....	0047, 0054, 0017, 0154, 0000, 0156, 0051, 0093, 0060, 0053, 0178, 0030, 0171, 0166, 0037, 0036, 0159, 0165, 0179, 0208, 0280, 1904, 1926, 0146, 0135, 0096, 0056, 0055, 0039, 0038, 0035, 0032, 0024, 0021, 0020, 0019, 0018, 0016	Shencai.....	0145, 0264, 0009, 0412	Simpson.....	0178, 0030, 0011, 0186, 0187	Sony .....	0000, 0834, 1599, 0017, 0154, 1100, 0150, 0053, 0037, 1505, 0036, 0650, 1925, 1904, 1751, 1685, 1651, 1619, 0011, 1317, 1300, 1167, 0074, 0810, 0080, 0632, 0353, 0157, 0111
Seaway .....	0634	Sheng Chia.....	0093, 0236, 0009, 0033, 0179, 0474, 1150	Singer .....	0060, 0037, 0433, 0009, 0092, 0247, 0335, 0371, 0891, 1537	Sound & Vision	0218, 0374
Seelver .....	1037	Shenyang .....	0264, 0009, 0696, 0753, 0817	Sinotec.....	0773	Soundesign .....	0180, 0178, 0019, 0056, 0179, 0186
SEG.....	0037, 0668, 1037, 0487, 0264, 0218, 0036, 0009, 0217, 0247, 0362, 1163	Sherwood.....	0009	Sinudyne.....	0037, 0361, 0163, 0177, 0544	Soundwave .....	0037, 0032, 0418
SEI.....	0037, 0163, 0177, 0544	Shintoshi .....	0037	Skantic.....	0163	Sowa .....	0156, 0051, 0060, 0178, 0036, 0226, 0092, 0474, 1150
Sei-Sinudyne....	0037, 0544	Shivaki.....	0178, 0556, 0037, 0374, 0443	SKY.....	0037, 0282, 0880	Soyea .....	0773
Seimitsu .....	0019	Shogun .....	0019	Sky Brazil.....	0880	Spectra.....	0009
Seleco .....	0264, 0163, 0346, 0362, 0371, 0411, 1351	Shorai .....	0179	Sky-North .....	0037	Spectravision ...	0156, 0178, 0159, 0179, 0186
Semivox .....	0236, 0463, 0180	Show .....	0009, 0418	Skygiant.....	0180	Spectricon.....	0003, 0032
Semp.....	0156, 1356	Siam .....	0037	Skysonic .....	0696, 0753	Spectroniq.....	1498
Sencora.....	0009	Siarem .....	0163	Skyworth.....	0748, 0037, 0698, 0264, 0009, 0696, 0753, 0817, 0825	Squareview.....	0171
Sentra .....	0035	Siemens.....	0145, 0037, 0195, 0032, 0146, 0157, 0200, 0327, 0535, 0554	Sliding.....	0865, 0880	SR2000 .....	0154, 0171
Serie Dorada....	0156, 0180, 0178, 0030, 0019, 0056	Siera .....	0556, 0037, 0012	SLX .....	0668	Ssangyong .....	0009, 0032
Serino .....	0093, 0610, 0455	Siesta .....	0370	Smaragd .....	0487	SSS .....	0180, 0019
Shancha.....	0264, 0412, 0817	Signature .....	0047, 0093, 0030, 0016, 0165, 0179, 0187	Solar Drape.....	0000, 0032	Stag.....	0032
Shanghai.....	0264, 0226, 0009, 0208, 0412, 0817	Signet .....	1262	Solavox .....	0037, 0548, 0361, 0032, 0163	Staksonic .....	0009
Shaofeng.....	0145, 0817	Silva .....	0037, 0361, 0648	Sole.....	0813	Standard.....	0037, 1037, 0218, 0009, 0217, 0374
		Silva Schneider	0037, 1556	Sonawa .....	0218	Standard Comps	0218, 0009
		Silvano.....	0587	Songba .....	0009	Starlite.....	0236, 0180, 0037, 0264, 0009, 0019, 0163
				Soniko .....	0037	Stenway .....	0218, 0282
				Soniq .....	1467	Stern .....	0264, 0163, 0411
				Sonitron .....	0370, 0208, 0217, 0339	Stevison .....	1982
				Sonix .....	1376		
				Sonneclair.....	0037		
				Sonoko .....	0037, 0264, 0009, 0217, 0282		

Strato .....	0037, 0264, 0009	Synco .....	0000, 0451, 0093, 0060, 0178, 0036, 0092, 0474	Tech Line .....	0037, 0668, 1163		0754, 0820, 0896, 1556
Strong .....	1149, 1163	Syntax .....	1144, 1240, 1331	Tech Lux.....	1189	Telefusión .....	0037
Studio Experience	0843	Sysline .....	0037	Technica.....	0218	Telegazi.....	0037, 0264, 0218, 0163
Stylandia .....	0217	T+A .....	0447	Technica.....	1982	Telemeister .....	0037
Sunkai .....	0610, 0487, 0218, 0455, 0355, 0865	Tacico .....	0178, 0009, 0092, 0179, 0474, 1150	Technics.....	0054, 0250, 0051, 0556, 0650, 0226, 0046, 0055	Telesonic .....	0037
Sunstar .....	0037, 0264, 0009, 0371	Tai Yi .....	0009, 1150	TechniSat .....	0556	Telestár .....	0556, 0037, 0009
Sunwatt .....	0455	Taishan .....	0009, 0374, 0817	Technisson .....	0714, 1289	Teletech .....	0037, 0668, 1037, 0009, 0247
Sunwood .....	0037	Talent .....	0178	Technol Ace .....	0179	Teleton .....	0036, 0179, 0186, 0217
Superla .....	0217	Tandberg.....	0361, 0109, 0367	Technosonic .....	0556, 0499	Televideon .....	0163
Superscan .....	0093, 0864	Tandy .....	0093, 0218, 0039, 0163, 0165, 0217, 0247	Technotrend .....	1531	Television .....	0037
Supersonic .....	0455, 0009, 0208, 1189	Tashiko .....	0036, 0650, 0032, 0033, 0092, 0146, 0163, 0170, 0217, 1150	Technovox .....	0030, 0217	Tempst .....	0264, 0455, 0009
SuperTech .....	0556, 0037, 0218, 0009	Tatung .....	0054, 0154, 0000, 0156, 0051, 0060, 0037, 0036, 0038, 0033, 0055, 0011, 0009, 0003, 0217, 0474, 1150, 1156, 1248, 1254, 1556, 1756	Techview .....	0847	Tennessee .....	0037
Supra .....	0178, 0009, 0039, 0056, 0374	TCC .....	0826	Techwood .....	0250, 0051, 0060, 0003, 0055, 0056, 1163	Tensai .....	0037, 1037, 0218, 0009, 0105, 0217, 0247, 0371, 00374
Supre-Macy .....	0039, 0046, 0186	TCL .....	0706, 0698, 0412, 0826, 1537	Tecnimagen.....	0556	Tenson .....	0009
Supreme.....	0000	TCM.....	0714, 0808, 1289	Teco .....	0051, 0093, 0178, 0264, 0218, 0036, 0653, 0009, 0092, 0280, 0474	Tera.....	0030, 0092, 0466, 0474
Susumu .....	0218, 0287, 0335, 0474	Teac .....	0706, 0154, 0178, 0171, 0037, 0714, 0668, 1909, 1037, 0698, 0712, 0264, 0455, 0418, 0512, 0544, 0412, 0689, 0282, 0217, 0170, 0159, 0146, 1149, 1755, 1904, 0009	Tedelex.....	0698, 0606, 0009, 0208, 0217, 0418, 0891, 1537	Tevion .....	0556, 0037, 0714, 0668, 1037, 1137, 0648, 0767, 0808, 1248, 1259, 1289, 1298, 1498, 1556
Sutron .....	0009	Tec .....	0037, 0009, 0163, 0217, 0247, 0335, 0474	Teiron .....	0009	Texet .....	0218, 0009, 0217, 0374
SV2000 .....	0054			Tek.....	0820	Texla .....	0780
SVA.....	0748, 0587, 0768, 0865, 0870, 0871, 0872			Teknika.....	0054, 0463, 0180, 0150, 0060, 0178, 0016, 0019, 0032, 0039, 0046, 0056, 0092, 0179, 0186	ThemeScene ....	0887
Svasa .....	0455			Teleavia .....	0287, 0343	Thomas .....	0047, 0178, 0019, 0039, 0056, 1904
Swisstec.....	0880			Telecolor .....	0017	Thomson .....	0047, 1447, 0037, 0625, 0560, 0109, 0287, 0335, 0343
Sydney .....	0217			Telecor .....	0037, 0218, 0163, 0217, 0394	Thorn .....	0037, 0361, 0264, 0036, 0035, 0074, 0109, 0163, 0335, 0343, 0499, 0512, 0535
Sylvania.....	1271, 0047, 0054, 0154, 0000, 0051, 0178, 0030, 0171, 0037, 0036, 0381, 1314, 1394, 1904, 1926, 1931, 0187, 0186, 0179, 0159, 0096, 0092, 0056, 0024, 0020			Telefunken.....	0702, 0037, 0625, 0714, 0560, 0486, 0698, 0712, 0587, 0498, 0346, 0343, 0335, 0287, 0109, 0074, 0056, 0753,	Thorn-Ferguson	0335, 0343, 0499

Tiane .....	0093, 0817	Toyoda .....	0264, 0009, 0371	0544, 0554, 1163,	Waltham .....	0037, 0668, 1037,	
Tiny .....	1269	Toyomenka .....	0178	0346, 0327, 0247,		0109, 0217, 0418,	
Tiny Digital .....	0660	Trakton.....	0264, 0217	0217, 0200, 0177,		0443	
TMK .....	0236, 0180, 0178,	Trans Continens	0037, 0668, 1037,	0170, 0157, 0146,	Wards .....	0047, 0054, 0017,	
	0056, 0177		0217	0109, 0105, 0074,		0154, 0000, 0156,	
TML.....	1756	TRANS-conts ..	0556, 0865	0070, 0032, 0011,		0051, 0093, 0236,	
TNCi.....	0017			0009		0180, 0060, 0178,	
Tobishi.....	0218	Transonic .....	0037, 0698, 0712,	Univox .....		0030, 0166, 0037,	
Tobo .....	0748, 0264, 0009,		0264, 0455, 0587,	V.....		0195, 0020, 0019,	
	0412		0009, 0418, 0512,			0165, 0179, 0018,	
			0780	V2max .....		0186, 0187, 0016,	
Tocom .....	0156	Triad .....	0556, 0218			0866, 1147, 1156,	
Tokai .....	0037, 0668, 1037,	Trical .....	0157	V7 Videoseven .		1347, 0151, 0135,	
	0009, 0163, 0217,	Trident.....	0217			0111, 0096, 0021,	
	0374	Trio.....	1498	Vector Research		0080, 0024, 0056,	
Tokaido.....	1037	Tristar.....	0264, 0218	Vestel .....		0055, 0027, 0033,	
Tokyo .....	0035	Triumph .....	0556, 0037, 0177,			0046, 0039, 0038,	
Tomashi.....	0218, 0282		0346	Vexa .....		0035	
Tongguang .....	0264, 0412	Truetone .....	0250, 0051, 0055	Victor .....		Warumaia .....	0374, 0661
Tongtel .....	0587, 0780	Tsoschi .....	0282			Watson .....	0037, 0714, 0668,
Tophouse .....	0180, 0672	Tuntex .....	0030, 0009, 0092,	Videocon.....			1037, 0218, 0009,
Topline.....	0668, 1037		0474	Videologic .....			0163, 0394, 0519,
Toshiba.....	1163, 1256, 1508,	TVS.....	0463	Videologique....		Watt Radio .....	0163, 0544
	1306, 0156, 1524,	TVTEXT 95 .....	0556	Videomac.....		Waycon .....	0156
	0154, 0093, 0150,	Uher.....	0037, 0486, 0370,	Videosat.....		Wega .....	0037, 0036
	1265, 0060, 1145,		0019, 0374, 0418,	VideoSystem....		Wegavox .....	0009
	0145, 0166, 0195,		0480	Videotechnic....		Weipai .....	0009
	1037, 0264, 0036,	Ultra .....	0019, 0039, 0092	Videoton.....		Welltech.....	0714
	0618, 0650, 0508,	Ultravox .....	0037, 0163, 0247,	Vidikron.....		Weltblick .....	0217
	1325, 1289, 1343,		0374	Vidtech.....		Welton .....	0178, 0019
	1356, 1360, 1369,	Unic Line .....	0037, 0455, 0473	Viewsonic .....		Weltstar .....	1037
	1456, 1556, 1635,	Unitech.....	0039			Westinghouse...	0885, 0000, 0451,
	1656, 1704, 1918,	United .....	0037, 0714, 1037,	Viking .....			0003, 0889, 0890,
	1935, 1936, 0009,		0587, 1916, 1982	Vision .....			1092, 1282, 1577
	0011, 0035, 0070,	Universal .....	0047, 0037, 0714,			Wharfedale .....	0556, 0037, 0519,
	0109, 0217, 0381,		0021, 0027, 0135	Vizio .....			0860, 0891, 0896,
	0412, 0423, 0509,	Universum .....	0037, 0668, 0195,			White Westinghs	0451, 0236, 0463,
	0644, 0718, 0832,		1037, 0361, 0264,	Vortex .....			0037, 1909, 0179,
	0845, 1150, 1156,		0370, 0036, 0618,	Voxson .....			0186, 0623, 0889
	1169, 1173		0362, 0411, 0418,			Winco .....	0412
Tosonic.....	0185		0473, 0474, 0480,			Windsor.....	0668, 1037
Totevision.....	0051, 0039		0492, 0512, 0535,				
Towada .....	0217						

Windstar ..... 0282  
 Windy Sam ..... 0556  
 Wintel ..... 0714  
 World ..... 0451, 0236, 0463,  
 0180  
 World-of-Vision ..... 0865, 0877, 0880,  
 0890, 1217, 1289,  
 1298  
 Worldview ..... 0455  
 Wyse ..... 1365  
 Xenius ..... 0634, 0661  
 Xiahua ..... 0698, 0264, 0009,  
 0412, 0773, 0817  
 Xianghai ..... 0009  
 Xiangyang ..... 0264, 0412  
 Xiangyu ..... 0009  
 Xihu ..... 0264, 0412, 0817  
 Xinaghai ..... 0412  
 Xingfu ..... 0009  
 Xinghai ..... 0264  
 XLogic ..... 0698, 0860  
 Xoro ..... 1196, 1217  
 XR-1000 ..... 0154, 0180, 0171,  
 0016, 0096, 0179  
 Xrypton ..... 0037  
 Yamaha ..... 0030, 0650, 0019,  
 0769, 0797, 0833,  
 0838, 0839, 1576  
 Yamishi ..... 0037, 0218, 0455,  
 0217, 0282  
 Yapshe ..... 0250  
 Yingge ..... 0009  
 Yokan ..... 0037  
 Yoko ..... 0037, 0264, 0370,  
 0218, 0009, 0217,  
 0247, 0339  
 Yonggu ..... 0009  
 Yorx ..... 0030, 0218  
 Youlanasi ..... 0817  
 Yousida ..... 0009

Ytaiwai ..... 1531  
 Yuhang ..... 0009  
 Zanussi ..... 0264, 0163, 0217  
 Zenith ..... 0047, 0017, 0000,  
 0093, 0463, 1265,  
 0812, 0178, 0030,  
 1145, 0145, 0171,  
 0037, 1909, 0146,  
 0092, 0039, 0016,  
 1305, 1904, 1911,  
 1929  
 Zenor ..... 0339  
 ZhuHai ..... 0009, 0374  
 Zonda ..... 0698, 0003

## CBL

3M ..... 0033  
 A-Mark ..... 0144, 0277, 0008,  
 0040  
 ABC ..... 0237, 0014, 0003,  
 0008, 0007, 0011,  
 0013, 0017, 0033  
 Accuphase ..... 0014, 0003, 0007,  
 0011, 0013, 0017  
 Acorn ..... 0237  
 Action ..... 0237  
 Active ..... 0237  
 ADB ..... 1082, 1230, 1269,  
 1927  
 Aichi Denshi ..... 1512  
 Aim ..... 0015  
 Allegro ..... 0153, 0315  
 American ..... 0060  
 Americast ..... 0899  
 Amstrad ..... 1222  
 Archer ..... 0237, 0153, 0797  
 Auna ..... 0277, 1230, 1269  
 Austar ..... 0276, 0012  
 BCC ..... 0276  
 Bell & Howell ..... 0014  
 Bell South ..... 0899  
 Birmingham  
 Cable Comms .. 0276  
 British Telecom ..... 0003  
 Cable & Wireless ..... 1068  
 Canal+ ..... 0443  
 Century ..... 0008, 0153, 0315  
 Citation ..... 0017  
 Citizen ..... 0153, 0242, 0315  
 Clearmaster ..... 0883  
 ClearMax ..... 0883  
 Colour Voice ..... 0025, 0031  
 Comcor ..... 1522  
 Comcrypt ..... 0443  
 Comtec ..... 0019  
 Comtronics ..... 0040, 0060  
 Contec ..... 0019  
 Cool Box ..... 0883  
 Coolmax ..... 0883  
 Curtis Mathes ..... 0015, 0242  
 Daeryung ..... 0877, 1877, 0477,  
 0277, 0008  
 Dalvi ..... 1522  
 Digeo ..... 1187  
 Digi ..... 0637  
 Director ..... 0476  
 Dumont ..... 0637  
 DX Antenna ..... 1500, 1502  
 Eastern ..... 0002, 0418  
 Emerson ..... 0014, 0015, 0797  
 Encon ..... 0008  
 Everquest ..... 0015, 0040  
 Fastweb ..... 1630  
 Filmnet ..... 0443  
 Focus ..... 0400

Force ..... 1798  
 Fosgate ..... 0276  
 Foxtel ..... 1222  
 France Telecom ..... 0817  
 Freebox ..... 1482  
 Fujitsu ..... 1497  
 Funai ..... 0019  
 Galaxi ..... 0008  
 Garrard ..... 0153  
 GC Electronics ..... 0040  
 GE ..... 0237, 0144, 0021  
 Gehua ..... 0476  
 Gemini ..... 0015, 0070, 0242,  
 0400, 0797  
 General Instr. .... 0476, 0810, 0014,  
 0276, 0003, 0012,  
 0011, 0015, 0024  
 Getterson ..... 0040  
 Gibraltar ..... 0003  
 GMI ..... 0015, 0797, 0883  
 Golden Channel ..... 1110  
 GoldStar ..... 0144, 0040  
 Goodmind ..... 0797  
 Hamlin ..... 0009, 0273, 0015  
 Hitachi ..... 0009, 0014, 0003,  
 0008, 0011, 0033  
 Houston ..... 0011  
 Humax ..... 1813  
 Hytek ..... 0007  
 Hytex ..... 0007  
 Insight ..... 0476, 0810  
 Jasco ..... 0015, 0153, 0315  
 Jebsee ..... 0014, 0400  
 Jerrold ..... 0476, 0810, 0014,  
 0276, 0003, 0012,  
 0011, 0015, 0024,  
 0031  
 Kabel Deutschld ..... 1981  
 Kabelvision ..... 0003



Kloss ..... 0277  
 KNC ..... 0008  
 Kuang Yu..... 0024  
 Leon..... 0015  
 LG ..... 0144, 0040  
 Macab ..... 0817  
 Macom ..... 0033  
 Madritel ..... 1230  
 Magnavox ..... 0014, 0797  
 Maspro ..... 1510  
 Matav ..... 1082  
 Melita ..... 0003  
 Mellenium ..... 0153  
 Memorex..... 0000  
 Mitsubishi..... 0003  
 MNET ..... 0019, 0443  
 Mood..... 1386  
 Motorola..... 1376, 0476, 0810,  
 1187, 1254, 0014,  
 0276, 1106, 0400,  
 1540  
 MS..... 0015  
 Multichoice..... 0019, 0443  
 Multitech ..... 0883  
 MultiVision..... 0012  
 NEC..... 1496  
 Nikkai ..... 0153  
 Nokia ..... 1569  
 Noos..... 0817, 1624  
 Nova Vision ..... 0277, 0008  
 Novaplex..... 0277, 0008, 0017  
 NSC..... 0012, 0070, 0400,  
 0637  
 NTL ..... 1068, 1060, 0276,  
 0003, 0277  
 Oak ..... 0019, 0007, 0017  
 Ono ..... 1068  
 Optimus ..... 0021  
 Optus ..... 1060, 0276

Pace ..... 0877, 1877, 0237,  
 1068, 1060, 0008,  
 1577  
 Panama ..... 0107, 0021  
 Panasonic ..... 0000, 0144, 0107,  
 0008, 0021, 0040,  
 0375, 1488  
 Panther..... 0637  
 Paragon..... 0000, 0525, 0008  
 Penney ..... 0000, 0637  
 Philips..... 0317, 0817, 0013,  
 0025, 0031, 0060,  
 0153, 0242, 0290,  
 1305  
 Pioneer ..... 0877, 1877, 0144,  
 0533, 0023, 1021,  
 1500  
 Popular Mechs . 0400  
 Prism ..... 0012, 0013  
 Pulsar ..... 0000, 0040  
 Pulser ..... 0040  
 PVP Stereo VM. 0003  
 Quasar ..... 0000  
 R-Line ..... 0040  
 RadioShack..... 0015, 0153, 0315,  
 0797, 0883  
 RCA ..... 1256, 0021, 0060,  
 0797  
 Realistic ..... 0153  
 Recoton..... 0153, 0400  
 Regal ..... 0279, 0273, 0276  
 Regency ..... 0002  
 Rembrandt ..... 0011, 0040, 0070,  
 0153  
 Runco ..... 0000  
 Sagem ..... 0817, 1624  
 Salora ..... 0000  
 Samsung ..... 0000, 0144, 1060,  
 0003, 0023, 0040,  
 0070, 1666  
 Satbox ..... 0375

Scientific Atlanta 0877, 1877, 0477,  
 0237, 0000, 0003,  
 0277, 0008, 0012,  
 0017, 0021, 0025,  
 1510  
 Sigma ..... 0019  
 Signal ..... 0011, 0015, 0040  
 Signature ..... 0011  
 SL Marx ..... 0040  
 Sony..... 1006, 1460  
 Sprucer ..... 0144, 0021  
 Starcom ..... 0014, 0003, 0015  
 Stargate ..... 0014, 0015, 0040,  
 0797  
 StarHub..... 0276, 1927  
 Starquest ..... 0015  
 Storm ..... 0637  
 Suena Madritel 1230  
 Sumitomo ..... 1500, 1503, 1504  
 Supercable..... 0276  
 Supermax ..... 0883  
 Tadiran ..... 0040  
 Tele+1 ..... 0443  
 Teleavia ..... 0040  
 Telenet ..... 1920  
 Telepiu..... 0443  
 Teletronik..... 1522  
 Teleview ..... 0040  
 Telewest..... 1068  
 Telsey ..... 1630  
 Thomson..... 1256, 1110, 1582  
 Time Warner cbl 1877  
 Timeless..... 0040, 0418  
 Tocom ..... 0019, 0012, 0013  
 Torx ..... 0003  
 Toshiba ..... 0000, 1509  
 Trans PX..... 0276, 0153, 0315  
 TransACT ..... 1106, 1386  
 Tristar ..... 0883

TS..... 0003, 0024  
 Tusa..... 0015  
 TV Comm ..... 0019  
 TV86 ..... 0040  
 Unika ..... 0153  
 United Artists .. 0007, 0024  
 United Cable .... 0014, 0276, 0003,  
 0011  
 Universal ..... 0153, 0315  
 UPC..... 1582  
 US Electronics . 0276, 0003, 0008,  
 0017  
 V2 ..... 0883  
 Videoway..... 0000  
 Viewmaster..... 0883  
 Viewstar..... 0060  
 Vision ..... 0883  
 Visiopass ..... 0817  
 Vortex View ..... 0883  
 Zenith ..... 0000, 0525, 0899,  
 0008, 0015, 0017,  
 0060, 0153, 0315  
 Zentek ..... 0400

## SAT

@sat ..... 1300, 1831  
 @Sky ..... 1334  
 ABSat ..... 0713  
 ADB..... 0642, 0887, 0241,  
 1259, 1367, 1418,  
 1473, 1491  
 Aiwa ..... 1514, 1515  
 Akai ..... 0200  
 Alba ..... 0455, 0713, 1284,  
 1659, 1811  
 Allsat ..... 0200, 0364, 1017

Allsonic.....	0369	Axis.....	1111, 0369	CityCom.....	0299, 0607, 0818, 1075, 1176, 1232	DiPro .....	1367, 1543
Alltech .....	0713	B@ytronic .....	1412	Classic .....	1672	DirecTV.....	1377, 0392, 0566, 0639, 1639, 1142, 0247, 0749, 1749, 0724, 0819, 1856, 1076, 1108, 0099, 1109, 1392, 1414, 1442, 1443, 1444, 1609, 1640
Allvision .....	1232, 1334, 1412	Bauckhage .....	1331	Clatronic .....	0332, 1413	Discoverer .....	0605
AlphaStar .....	0772	Beko .....	0455	Clemens Kamphus	0396	Dish Network Sys	1505, 1005, 0775, 1170, 1775
Amitronica.....	0713	Bell ExpressVu .	0775	CNS .....	1367	Dishpro.....	1505, 1005, 0775, 1775
Ampere .....	0132, 0396	Bentley Walker .	1017	Cobra .....	0396	Distratel .....	0885, 1283, 1704
Amstrad.....	0847, 1175, 0132, 0338, 0396, 0713, 0885, 1113, 1693, 1801	Best .....	0369	Colombia.....	0132	DMT.....	1075
Anglo .....	0713	Big Sat.....	1457	Columbia.....	0132	DNT .....	0200, 0396
Ankaro .....	0369, 0713, 1279	Black Diamond .	1284	Comag .....	0132, 1232, 1366, 1412, 1413, 1579	Dream Multimedia	1237
AntSat .....	1017, 1083	Blaupunkt .....	0173	Condor .....	0369, 0607	DSE .....	1375
Apollo .....	0455	Blue Sky .....	0713	Connexions.....	0369, 0396	DSTV .....	0879, 0642, 1433
Arcon .....	0332, 1075, 1279	Blue Star .....	1279	Conrad .....	0132, 0369, 0607	Dune.....	0369
Arcus .....	1143	Boca .....	0132, 0713, 1232, 1366	Coship .....	1457	Durabrand .....	1284
Arion .....	1115	Bose .....	1616	Crossdigital.....	1109	DX Antenna .....	1530
Armstrong .....	0200	Boston .....	1251	Crown .....	1284	Echostar .....	1505, 1005, 0775, 0853, 0167, 0610, 1200, 1775, 1767, 1473, 1418, 1409, 1323, 1170, 0713, 0455, 0396
Arnion .....	1300	Brainwave .....	0332, 0658, 1294, 1672	Cryptovision.....	0455	Einhell.....	0132, 0713
Asat.....	0200	British Sky Bcasting	0847, 1175, 1656, 1662	Cyfra+ .....	1076	Elap .....	0713, 1129, 1567
ASCI.....	0114, 1334	Broco .....	0713	Cyrus .....	0200	Electron .....	1279
ASLF .....	0713	BskyB .....	0847, 1175, 1662	D-box .....	0723, 1114	Elsat .....	0713
AssCom .....	0853	BT.....	1296	Daeryung.....	0396	Elta .....	0200, 0364, 0369, 1659
AST .....	0321	Bubu Sat.....	0713	Daewoo .....	1111, 0713, 1296, 1743	Emme Esse .....	0369
Aston .....	1129, 1261	Bush .....	1284, 1471, 1645, 1672, 1743, 1811	Deltasat.....	1075	Energy Sistem ..	1631
Astra .....	0607, 0713	Canal .....	0853	Dgtec .....	1242, 1542, 1631	Engel .....	0713, 1017, 1251
Astratec.....	1743	Canal Digital ....	0853, 1622, 1780	Digatron .....	1294	EP Sat .....	0455
Astro .....	0173, 0369, 0607, 0658, 1099, 1100, 1113	Canal Satellite ..	0853, 0292, 1339, 1853	Digenius .....	0299, 1161	Esat .....	0879
Atsat .....	1300, 1831	Canal+ .....	0853	Digitality .....	0607	Eurieult .....	0885
AtSky .....	1334	Centrex .....	1457	Digifusion .....	1645, 1743		
Audioline .....	1672	Century.....	0856	DigiLogic .....	1284		
Audioton.....	0364	CGV .....	1413	DigiQuest .....	1300, 1457, 1473		
Aurora .....	0879, 0642, 1433	Chaparral .....	0216	DigiSat .....	1232		
Austar .....	0879, 0642, 0494, 1176, 1259	Chess .....	0114, 0713, 1334, 1626	Digisky .....	1457		
Avalon .....	0396	Chili .....	1718	DigitAll World ..	1227		
Axil .....	1457, 1659			Digiturk.....	1076		
				Digiwave .....	1631		
				Dijam .....	1296		

Eurocrypt ..... 0455  
 EuroLine ..... 1251  
 Europa ..... 0607  
 Europhon ..... 0132, 0299, 0607  
 Eurosky ..... 0132, 0114, 0299,  
 0369, 0607  
 Eurostar ..... 0607, 0818  
 Eutelsat ..... 0713  
 Expressvu ..... 0775, 1775  
 Eycos ..... 1279  
 Fagor ..... 0364  
 Fenner ..... 0369, 0605, 0713  
 Ferguson ..... 0711, 0455, 1291,  
 1743  
 Finepass ..... 1593, 1780  
 Finlandia ..... 0455  
 Finlux ..... 0455  
 Flair Mate ..... 0713  
 FMD ..... 0114, 1251, 1413,  
 1457  
 Fortec Star ..... 1017, 1083  
 Foxtel ..... 0879, 0720, 0455,  
 1176, 1356  
 Fracarro ..... 0125  
 Freecom ..... 0335  
 Fresat ..... 0885  
 FTEmaximal .... 0369, 0713  
 Fuba ..... 0173, 0299, 0369,  
 0396, 1161, 1214,  
 1251, 1801  
 Fugionkyo ..... 0125  
 Funai ..... 1377, 0338  
 Galaxis ..... 0853, 1111, 0879,  
 0364, 0369, 1557  
 Galaxisat ..... 0321  
 Gardiner ..... 0818  
 Garnet ..... 1075  
 GbSAT ..... 1214  
 GE ..... 0392, 0566

Gecco ..... 1412  
 General Instr. ... 0869  
 General Satellite 1176  
 Globo ..... 1251, 1334, 1412,  
 1429, 1626  
 GOD Digital ..... 0200  
 GOI ..... 0775, 1775  
 Gold Box ..... 0853, 0292  
 Gold Vision ..... 1017, 1631  
 Golden Interstar 1283  
 GoldStar ..... 0335  
 Goodmans ..... 0455, 1246, 1284,  
 1291  
 Gradiente ..... 0856, 0099, 0887  
 Granada ..... 0455  
 Grothusen ..... 0335  
 Grundig ..... 0847, 0853, 0173,  
 0879, 1291  
 Haensel & Gretel 0132  
 Handan ..... 1622, 1780  
 Hanseatic ..... 0605, 1099, 1100  
 Hantor ..... 0332  
 Hauppauge ..... 1294, 1672  
 HB ..... 1214, 1801  
 HDT ..... 1159  
 HE@D ..... 1279  
 Heliocom ..... 0607  
 Helium ..... 0607  
 Hills ..... 1232  
 Hirschmann ..... 1111, 0173, 0125,  
 0299, 0369, 0396,  
 0607, 1232, 1412  
 Hisawa ..... 0332  
 Hisense ..... 1535  
 Hitachi ..... 0749, 0819, 0214,  
 0455, 0489, 0491,  
 1250, 1284, 1518,  
 1523, 1525  
 HNE ..... 0132

Homecast ..... 1214, 1680  
 Hornet ..... 1300  
 Houston ..... 0775, 0396  
 HTS ..... 0775, 1775  
 Hughes Net Sys 1142, 0749, 1749,  
 1442, 1443, 1444  
 Humax ..... 1176, 1427, 1670,  
 1675, 1743, 1790,  
 1882, 1915  
 Hung Chang ..... 0732  
 Huth ..... 0132, 0332, 0335,  
 0364, 0607, 1017,  
 1075, 1143  
 Hwalin ..... 0885  
 Hyundai ..... 1075, 1159  
 iCan ..... 1367  
 ID Digital ..... 1176  
 IEEC ..... 0605  
 ILLUSION sat... 1557, 1631  
 iLo ..... 1535  
 Imperial ..... 1334, 1429, 1672  
 Indovision ..... 0887  
 Ingelen ..... 0114, 0396  
 Innova ..... 0099  
 International .... 0132  
 Interstar ..... 1017, 1214  
 Intervision ..... 0364, 0607  
 Irradio ..... 1331  
 ISkyB ..... 0887  
 ITT Nokia ..... 0723, 0455  
 Jadeworld ..... 0642  
 Jaeger ..... 1334  
 Jerrold ..... 0869  
 JiWon ..... 0364  
 Johansson ..... 0332, 0364  
 Jolly ..... 0364  
 JSR ..... 0364

JVC ..... 0775, 0492, 1170,  
 1507, 1531, 1532,  
 1775  
 K-SAT ..... 0713  
 Kamm ..... 0713  
 Kaon ..... 1300, 1583  
 KaTelco ..... 1111  
 Kathrein ..... 0173, 0200, 0114,  
 0480, 0504, 0553,  
 0658, 0713, 0818,  
 1416, 1561, 1567,  
 1706, 1707, 1709  
 Kennex ..... 0125  
 Kenwood ..... 0853  
 Key West ..... 0132  
 Kiton ..... 0114  
 Konig ..... 0607  
 Kosmos ..... 0335  
 Kreatel ..... 1385  
 Kreiling ..... 0114, 0658  
 Kreiselmeyer ..... 0173  
 L&S Electronic . 0132, 0369, 1334  
 Labgear ..... 1296  
 LaSAT ..... 0173, 0132, 0299,  
 0369, 0607  
 Lava ..... 1631  
 Legend ..... 1718  
 Legrand ..... 1718  
 Lemon ..... 1334  
 Lenco ..... 0335, 0369, 0607,  
 0713  
 Lennox ..... 0369  
 Lenoxx ..... 1611  
 LG ..... 0335, 1075, 1226,  
 1414  
 Lifesat ..... 0132, 0299, 0369,  
 0605, 0713  
 Lodos ..... 1284  
 Logik ..... 1284  
 Logix ..... 1017, 1075

Lorenzen .....	0132, 0299, 0607, 1161, 1294, 1579	Microtec.....	0713	Optex .....	0114, 0364, 0713, 1283, 1611	Pioneer .....	1142, 0853, 0292, 0329, 0352, 1308, 1442
Lorraine .....	0335	Mitsubishi .....	0749, 0455, 0491	Optimus .....	0724	Planet .....	0396
Lupus .....	0369	Morgan's.....	0200, 0132, 0364, 0713, 1232, 1412	Optus .....	0879, 1143	PMB .....	0713, 1611
M Electronic ....	0818	Motorola .....	0869, 0856, 1473	Orbis .....	1232, 1334, 1412	Polytron .....	0396
M vision.....	1557	MTEC.....	1214	Orbitech .....	0114, 1099, 1100	Portland.....	1296
M&B .....	0605	Multibroadcast .	0879, 0642	P/Sat .....	1232	Power Sky .....	1279
Magnavox .....	0724, 0722	Multichoice .....	0879, 0642, 1433, 1559, 1560	Pace.....	0847, 0853, 0200, 0887, 0720, 1175, 0791, 0455, 0329, 0241, 1323, 1356, 1423, 1623, 1693, 1717, 1848, 1850	Predki .....	0332
Manata .....	0132, 0713	Muratto .....	0321, 0335	Pacific .....	1284, 1375	Preisner .....	0132, 0396, 1113, 1366
Manhattan .....	0332, 0364, 0455, 1017, 1083	Mx Onda.....	1659	Packard Bell.....	1111	Premier.....	0853, 0723, 0292, 1429
Marantz .....	0200	Myryad .....	0200	Palcom .....	0299, 1161, 1331, 1409	Primacom .....	1111
Maspro .....	0173, 0713, 1520, 1530	Mysat .....	0713	Palladium .....	0396	Primestar .....	0869
Matsui .....	0173, 0332, 1284, 1743	MySky .....	1693, 1848, 1850	Panarex .....	1159	Promax .....	0455
Matsushita.....	0214, 0340, 0500	Navex .....	0332	Panasat .....	0879, 1433	Proscan .....	0392, 0566
Max .....	0607	NEC .....	0496, 1270, 1519, 1617	Panasonic .....	0247, 0701, 0847, 0214, 0340, 0455, 0500, 1304, 1404, 1508, 1526, 1527, 1528	Proton .....	1535
Maximum .....	1075, 1334	NEOTION.....	1334	Panda .....	0173, 0455, 0607	QNS.....	1367, 1404
McIntosh .....	0869	Netgem .....	1322	Pansat .....	1159, 1807	Quadral.....	0369
Mediabox .....	0853, 0292	Netsat .....	0099, 0887	Patriot .....	0132	Quali-TV .....	1955
Mediacom .....	1206	Neuf TV.....	1322	Paysat .....	0724	Quelle .....	0299, 0607
MediaSat .....	0853, 0292	Neuhaus .....	0607, 0713	peekTOn.....	1457	Radiola .....	0200
Medion .....	0132, 0299, 0369, 0713, 1075, 1161, 1232, 1334, 1412, 1626	Neuling .....	0132, 1232	Philips .....	1142, 0749, 1749, 0775, 0724, 0819, 0856, 1076, 0722, 0099, 0847, 0853, 0173, 0200, 1114, 0887, 0292, 0818, 0455, 0133, 1442, 1543, 1672	RadioShack.....	0566, 0775, 0869
Medison .....	0713	Neusat .....	0713, 1279, 1331	Phonotrend .....	1200, 0364, 1017	Radix .....	0396, 1113, 1317
Mega .....	0200	Neveling.....	1161	Pilotime .....	1339	RCA.....	0392, 0566, 1142, 0775, 0855, 0143, 1291, 1392, 1442
Memorex .....	0724	Nevir .....	1659	Pino.....	1334	Rebox .....	1214
Metronic .....	0132, 0713, 0818, 0885, 1279, 1283, 1334, 1375, 1704	Newton .....	0396			Redstar.....	0369
Metz .....	0173	Next Level.....	0869			Regal .....	1251
MiCO .....	1811	NextWave .....	0732, 1017, 1143			RFT.....	0200
Micro .....	0607, 0713, 1294	Nikko .....	0723, 0200, 0713			Roadstar.....	0853, 0713
Micro Elektronik	0713	Noda Electronic	0885, 1704			Rollmaster .....	1413
Micro Technology	0713	Nokia .....	0853, 0723, 0455, 1023, 1223, 1311, 1723			Rover .....	0369, 0713
Micromaxx .....	0299, 0369	Nordmende .....	0455, 1611			Rownsonic .....	1567
Microstar .....	1075	Novis .....	0332			S-ZWO .....	1207
		OctalTV.....	1505, 1294			SAB .....	1251
		Omega .....	0887			Saba .....	0820, 0607, 0885
		Opentel.....	1232, 1412				

Sabre .....	0455	Sharp .....	0494, 1489, 1513, 1517, 1955	Stream .....	1848	Telestar .....	0114, 1099, 1100, 1251, 1334, 1610, 1626
Sagem .....	0820, 1114, 1253, 1690, 1692	Siemens.....	0173, 0396, 1334, 1429, 1657	Strong .....	0853, 0820, 0879, 0132, 0125, 0369, 0713, 1159, 1284, 1300, 1409, 1626, 1765	Telesystem .....	1801
Samsung.....	1377, 1142, 1276, 1108, 1109, 0853, 1017, 1206, 1293, 1442, 1458, 1570, 1609, 1795, 1916	Silva .....	0299, 0335	Sunny .....	1300	Teletech.....	0114
Sanyo .....	0493, 1219	Skantin .....	0713	Sunny Sound ...	0369	Televés .....	0132, 0455, 1214, 1300, 1334, 1742
SAT.....	0321	SKR .....	0713	Sunsat .....	0713	Televisa.....	0887
Sat Control.....	1300	SKY .....	0856, 1856, 0099, 0847, 0887, 1175, 0711, 1656, 1662, 1693, 1848, 1850	Sunstar .....	0642, 0132, 0369	Telewire .....	0364, 1232
Sat Cruiser .....	1143	Sky Brazil.....	0856, 0887	Supermax .....	1143, 1283	Tempo .....	1143
Sat Partner.....	0332, 0335	SKY Italia.....	0853, 1693, 1848	Supernova .....	0887	Tensai .....	0332
Sat Team .....	0713	Sky XL .....	1251, 1412	Systec .....	1334	Tevion .....	0713, 1409, 1593, 1622, 1672
SAT+ .....	1409	Sky+ .....	1175	Tagra .....	0364	Thomson .....	0392, 0566, 0847, 0853, 0820, 1175, 0292, 0711, 0713, 0607, 0455, 0885, 1046, 1291, 1534, 1543, 1662
Satcom .....	0605, 0607	Skymaster .....	1200, 0605, 0713, 1075, 1334, 1409, 1567, 1611	Tantec .....	0455	Thorn .....	0455
Satec .....	0713	Targa .....	1807	Tatung .....	0455	Tiny.....	1672
Satelco.....	0369, 1232	Tatung .....	0455	TBoston .....	1659	Tioko .....	0132
Satplus.....	1100	TCL .....	1143	Teac .....	1227, 1251, 1322	Tivo.....	1142, 1442, 1443, 1444
Satstation.....	1083	Tecatel.....	1200	Tecatel.....	1200	Tokai .....	0200
Schaub Lorenz.	1214	Techniland.....	0364	TechniSat .....	0114, 0396, 0455, 1099, 1100, 1195, 1197, 1322	Tonna .....	0364, 0455, 0713, 1611
Schneider .....	1206, 1251	Technomate .....	1283, 1610	Technosonic.....	1672	Topfield.....	1206, 1207, 1208, 1545, 1783, 1824
Schwaiger .....	1111, 0132, 0504, 0605, 0607, 0732, 0885, 1075, 1083, 1317, 1334, 1412, 1457	Technoson.....	1429	Technotrend.....	1429	Toshiba.....	0749, 1749, 0790, 0819, 0455, 0486, 1285, 1446, 1501, 1516, 1530
SCS.....	0299, 1331	Technowelt.....	0132, 0607	Technoson.....	1672	TPS.....	0820, 1253
Sedea Electro. .	0132, 0125, 1206, 1279, 1283, 1626	Techsan.....	1017	Technosonic.....	1672	Triad .....	0321, 0335
Seemann.....	0396	Techwood .....	0114, 1284, 1626	Technotrend.....	1429	Triax .....	0853, 0200, 0132, 0114, 0396, 0713, 1113, 1227, 1251, 1291, 1296, 1626, 1742
SEG.....	0114, 0332, 0369, 0605, 1075, 1251, 1626	tekComm .....	1017	Technowelt.....	0132, 0607	Trio .....	1075
Seleco .....	0364	Telasat.....	0605, 0607	Techsan.....	1017	TT-micro .....	1429
Septimo.....	0885, 1375	Tele System Elec.	0396, 1251, 1409, 1611, 1801	Technowelt.....	0132, 0607		
Serd.....	1412	TeleClub.....	1367	Techsan.....	1017		
Serino .....	0610	Teleka .....	0396, 0607	Technowelt.....	0132, 0607		
Servimat.....	1611	Telesat.....	0605, 0607	Technowelt.....	0132, 0607		
ServiSat.....	0713, 1251			Technowelt.....	0132, 0607		
		SR.....	0132	Technowelt.....	0132, 0607		
		Star.....	0887	Technowelt.....	0132, 0607		
		Star Choice.....	0869	Technowelt.....	0132, 0607		
		Star Trak .....	0772, 0869	Technowelt.....	0132, 0607		
		Starland .....	0713	Technowelt.....	0132, 0607		
		Starlite .....	0200	Technowelt.....	0132, 0607		
		Starring.....	0332	Technowelt.....	0132, 0607		

Turnsat ..... 0713  
 Twinner ..... 0713, 1611, 1742  
 UEC ..... 0879, 1356  
 UltimateTV ..... 1392, 1640  
 Uniden ..... 0724, 0722, 1521  
 Unisat ..... 0200, 0132  
 United ..... 1251  
 Unitor ..... 0332  
 Universum ..... 0173, 0114, 0299,  
 0607, 1099, 1251  
 US Digital ..... 1535  
 USDTV ..... 1535  
 Van Hunen ..... 1161  
 Variosat ..... 0173  
 Vega ..... 0369  
 Ventana ..... 0200  
 Versatel ..... 1795  
 Vestel ..... 0114, 1251  
 VH Sat ..... 0299  
 Viasat ..... 1682  
 Victor ..... 0492  
 Vidtech ..... 0321  
 ViewSat ..... 1232  
 Visionic ..... 0125, 1279, 1283  
 VisionNet ..... 1557  
 Visiosat ..... 0114, 0713, 1129,  
 1413, 1457, 1718,  
 1742, 1807  
 Viva ..... 0856  
 Voom ..... 0869  
 VTech ..... 0321, 0818  
 Wavelength ..... 1232, 1413  
 Wetekom ..... 0605  
 Wewa ..... 0455  
 Wharfedale ..... 1284  
 Winbox ..... 1801  
 Winersat ..... 0332  
 Wintel ..... 0299, 1161

Wisi ..... 0173, 0132, 0299,  
 0321, 0396, 0455,  
 0607  
 World ..... 0332  
 Worldsat ..... 0114, 1214, 1251,  
 1543  
 XMS ..... 1075  
 Xoro ..... 1807  
 Xrypton ..... 0369  
 Xsat ..... 0847, 0713, 1214,  
 1323  
 Xtreme ..... 1300  
 Yakumo ..... 1413  
 Yamada ..... 1718  
 Yes ..... 0887  
 Zehnder ..... 0114, 0321, 0369,  
 0504, 0818, 1075,  
 1232, 1251, 1616  
 Zenith ..... 0856, 1856  
 Zeta Technology ..... 0200  
 Zodiac ..... 0396, 1801

## CD/DVD

RCA ..... 0522  
 Sharp ..... 0037  
 Sony ..... 0878, 1033  
 Universum ..... 0053

## DVD

3D LAB ..... 0503, 0539  
 4Kus ..... 1158  
 A-Trend ..... 0714  
 Accurian ..... 1072, 1416

Acoustic Solutions 0730, 0713, 1228,  
 1242, 1316  
 Adcom ..... 1094  
 Advent ..... 1016  
 AEG ..... 0770, 0790, 0788  
 AFK ..... 1051, 1152  
 Afreedy ..... 0698  
 Aim ..... 0672, 0699, 0778,  
 0833, 1165, 1177  
 Airis ..... 0672, 0826, 1005,  
 1107, 1224, 1321,  
 1345  
 Aiwa ..... 0533, 0641  
 Akai ..... 0770, 0695, 0790,  
 0690, 0705, 0716,  
 0766, 0779, 0788,  
 0884, 0898, 0899,  
 1089, 1115, 1233  
 Akashi ..... 0838  
 AKI ..... 1005  
 Akira ..... 0699, 1321  
 Akura ..... 0898, 1051, 1140,  
 1171, 1233, 1367  
 Alba ..... 0672, 0539, 0717,  
 0695, 0730, 0699,  
 0713, 0783, 0884,  
 1140, 1530, 1610  
 Albatros ..... 1001  
 Alco ..... 0790  
 Alize ..... 1151  
 All-Tel ..... 0835, 1451  
 Allegro ..... 0869  
 Altacom ..... 1224  
 Amisos ..... 0782  
 Amitech ..... 0784, 0770, 0850  
 Amoi ..... 0852  
 Amoisonic ..... 0835  
 Amphion Media Works 0872, 1245  
 Amstrad ..... 0770, 0713, 1151,  
 1173, 1367, 1407

Amuseer ..... 1351  
 AMW ..... 0872, 1245  
 Ansonic ..... 0831, 0759, 1316,  
 1351  
 Apex Digital ..... 0533, 0672, 0717,  
 0755, 0794, 0796,  
 0797, 0830, 1004,  
 1020, 1056, 1061,  
 1100, 1126  
 Aria ..... 0893  
 Arianet ..... 0818, 0893  
 Aristona ..... 0539, 0646  
 Arrgo ..... 1023  
 Asono ..... 1224  
 Aspire Digital ... 1168, 1407  
 Astar ..... 1489  
 Atacom ..... 1224  
 Audiologic ..... 0736  
 Audiosonic ..... 0690, 1265  
 Audiovox ..... 0717, 0790, 1041,  
 1071, 1072, 1121,  
 1122  
 Audioworld ..... 0790  
 Autovox ..... 0713  
 Auvio ..... 0843  
 Aviovis ..... 1165  
 Awa ..... 0730, 0872  
 Axion ..... 0730, 1071, 1072,  
 1193  
 B & K ..... 0655, 0662  
 Bang & Olufsen 1696  
 Base ..... 1451  
 Basic Line ..... 0713  
 Baze ..... 0898, 1165  
 BBK ..... 0862, 1224  
 Beep ..... 1163  
 Bel Canto Design 1571  
 Bellagio ..... 1004, 1245  
 Belson ..... 1086

Best Buy .....	1089	Centrum.....	0713, 0779, 0789, 1005, 1227		1117, 1129, 1173, 1502, 1537	digiRED .....	0717
Black Diamond.	0713, 0766, 0833, 0884	CGV.....	0751, 1115	Cydectin.....	1074	Digital i .....	0893
Blaupunkt .....	0717	Changhong .....	0627, 1061	Cytron .....	0651, 0705, 0716, 1347	DigitalMax .....	1738
Blu:sens .....	1233, 1321, 1489	Cinea .....	0831, 0841	D-Link .....	1881	Digitor.....	0651, 0690, 0833, 1005, 1423
Blue Nova Intn .	1321	Cinego .....	1399	D-Vision .....	1115, 1367	Digitrex .....	0672, 1004, 1056, 1100
Blue Parade .....	0571	Cineral .....	0730	Daenyx .....	0872	Digix Media .....	0826
Blue Sky.....	0672, 0651, 0695, 0790, 0699, 0713, 0778, 0804, 0843, 1423	Cinetec.....	0713, 0872	Daewoo .....	0490, 0784, 0770, 1483, 1443, 1441, 1436, 1242, 1234, 1172, 1169, 1072, 0872, 0869, 0833, 0714, 0705	DiK .....	0831
Boghe .....	1004	cineULTRA .....	0699			Dinamic .....	0788
Boman .....	0783, 0898, 1005	CineVision.....	0876, 0833, 0869, 1483	Dalton .....	1036, 1107	Disney .....	0831, 0675, 1270
Bose.....	2023	Citizen .....	1003, 0695, 1277	Dansai .....	0770, 0783, 1115	DiViDo .....	0705
Brainwave .....	0770, 1115	Clairtone .....	0571	Dantax .....	0539, 0790, 0713, 0723, 1089	DK Digital .....	0831
Brandt .....	0503, 0651, 0551	Classic.....	0730, 1730	Daytek .....	0872, 1005	DMTech .....	0783, 1072
Broksonic .....	0695, 0868, 1419	Clatronic .....	0672, 0675, 0788, 0818, 1165, 1177, 1233	Dayton.....	0872	Dragon .....	0831
Buffalo.....	1882	Clayton.....	0713	DCE.....	0831	DreamX .....	1151
Bush.....	0672, 0717, 0730, 0831, 1483, 1436, 1419, 1351, 1177, 1165, 1140, 1128, 1051, 0884, 0879, 0833, 0778, 0758, 0723, 0713, 0699, 0690, 0516	Coby.....	0730, 0778, 0852, 1077, 1086, 1107, 1165, 1177, 1321, 1351	Decca .....	0770, 1115	DSE .....	0833, 1152, 1483, 1730
Byd:sign .....	0872	Codex .....	1233	Denon .....	0490, 0634, 1282, 1634	DTS .....	0799
C-Tech .....	0798, 1152	Commax .....	1321	Denver .....	0672, 0699, 0778, 0788, 0898, 1056, 1104, 1107, 1165, 1177, 1265, 1316, 1321	Dual.....	0651, 0730, 0831, 0790, 0665, 0675, 0713, 0779, 0783, 1023, 1068, 1085, 1436
Calif Aud Labs..	0490	Compacts.....	0826, 1107, 1265				
Cambridge Aud	0751, 1109, 1589	Conia .....	0672, 0516, 0835, 0852, 1321	Denzel .....	0665	Durabrand .....	1003, 0831, 0713, 1023, 1127, 1502
Cambge Sndwks	0690	Contel .....	0788	Desay .....	0800, 0843, 1407, 1455	DVD2000 .....	0521
Campomatic Dig.	1051	Continental Ed.	0831, 0872	Dgtec .....	0672	DVX .....	0768
Cary Audio Des	1477	Craig .....	0831	Diamond .....	0651, 0768, 0790, 0751, 0778	E:max .....	1233, 1321
Cat .....	0699, 0789, 1421	Creative .....	0503, 0539	Diamond Vision	1316, 1609, 1610	EagleTec.....	0714
CAVS.....	1057	CrossWood .....	1446	Dick Smith Elec	0833, 1152, 1483, 1730	eBench .....	1152
CCE.....	0730	Crown .....	0770, 0690, 0713, 0769, 1115	Digihome.....	0713	ECC.....	0730
Celestial .....	1020	Crypto .....	1228	DigiLogic .....	0713	Eclipse.....	0723, 0751
cello .....	1730	Curtis Mathes ...	1087			Electrohome.....	1003, 0893
Centrex .....	0672, 1004	Cybercom.....	0831			Elfunk .....	0713, 0850, 0884
Centrios.....	1577	CyberHome .....	0714, 0816, 0874, 1017, 1023, 1024,			Elin .....	0770

	1115, 1151, 1173, 1233	GoldStar .....	0591, 0741, 0801, 0869	Hoehner .....	0651, 0831, 0713, 0826, 1004, 1224	Kansas Tech. ....	1233, 1530
Eltax .....	0766, 1233, 1321	Goodmans .....	0651, 0730, 0790, 0690, 0713, 0723, 0783, 0833, 0879, 1004, 1140, 1177, 1316, 1423, 1530, 1730	Home Elec. ....	0770, 0730	Karcher .....	0783
Emerson .....	0591, 0675, 0705, 0821, 1268	GP Audio .....	1140	Home Tech Indus.	1107, 1224	Kawasaki .....	0790
Encore .....	0698	GPX .....	0741, 0699, 0769	Hoyo .....	0665	Kendo .....	0672, 0831, 0699, 0713
ENTERprise .....	0591	Gradiente .....	0490, 0651	Humax .....	0646, 1588	Kennex .....	0770, 0713, 0898
Entivo .....	0503, 0539	Graetz .....	0665	Hyundai .....	0766, 0783, 0850, 1061, 1228	Kenwood .....	0490, 0534, 0682, 0737, 1063
Enzer .....	0784, 0770, 0766, 1228	Gran Prix .....	0831, 0898	I-O Data .....	1405	Kiiri .....	0770
ESA .....	0821, 1268, 1443	Grandin .....	0713, 0716, 1173, 1233	iLo .....	1348, 1472	King DHome .....	0799
EuroLine .....	0675, 0788, 1115, 1233, 1351	Greenhill .....	0717	Ingelen .....	0788	Kingavon .....	0818
Fenner .....	0651	Grundig .....	0539, 0651, 0551, 0695, 0790, 0670, 0705, 0713, 0775, 1004, 1036, 1128, 1177, 1436, 1730	Ingersol .....	1023	Kiss .....	0665, 0841, 1523
Ferguson .....	0651, 0695, 0713, 0884, 0898, 1730	Grunkel .....	0770, 0831, 0790, 1316	Initial .....	0839, 0717, 1472	KLH .....	0815, 0717, 0790, 1020, 1149, 1261
Finlux .....	0672, 0591, 0741, 0770, 0751, 0783, 1165	GVG .....	1169	Inno Hit .....	0713	Kloss .....	0533
Fintec .....	1169	H & B .....	0713, 0818, 0841, 0850, 1233, 1421	Innovative Tech.	1542	Koda .....	1230
Firstline .....	0651, 0713, 0799, 0843, 0869, 1530	Haaz .....	0751, 1152	Insignia .....	1013, 1268	Konka .....	0711, 0719, 0720, 0721
Fisher .....	0670	Haier .....	0843	Integra .....	0571, 0627, 1634	Konka .....	0711, 0719, 0720, 0721
Funai .....	0695, 0675, 1268, 1334	Hanseatic .....	0741, 0790, 0783	Irradio .....	0869, 1115, 1224, 1233	Koss .....	0651, 0769, 0896, 1061, 1423
Fusion .....	0862	Harman/Kardon	0582, 0702	IRT .....	0783, 1489	Kreisen .....	1421
Gateway .....	1073, 1077, 1158, 1194	HCM .....	0788	ISP .....	0695	KXD .....	0857, 1321
GE .....	0522, 0815, 0717	HDT .....	0705	Jamo .....	1036	Landel .....	0826
General Electric	0717	HE .....	0730, 1163	Jaton .....	0665, 1078	Lasonic .....	0627, 0798, 0789, 1173
Germatic .....	1051	Helios .....	2080	Jay-tech .....	1265	Lawson .....	0768, 0716
Global Link .....	1224	Henss .....	0713	JBL .....	0702	Lecson .....	1533
Global Solutions	0768	Himage .....	1089	JDB .....	0730	Leiker .....	0872
Global Sphere ..	1152	HiMAX .....	0843	JDV .....	1367	Lenco .....	0651, 0770, 0699, 0713, 0778, 1165, 1177
Go Video .....	0573, 0744, 0717, 0741, 1730, 1483, 1443, 1304, 1158, 1144, 1099, 1075, 1044, 0869, 0833, 0783, 0715	Hitachi .....	0573, 0664, 0695, 0665, 0713, 0857, 1247, 1664	Jeken .....	0699	Lenoir .....	1228
Go Vision .....	1071, 1072	Hiteker .....	0672	Jensen .....	1016	Lenoxx .....	0690, 0838, 1127
				Jeutech .....	0766	Lexia .....	0768, 0699
				JMB .....	0695	LG .....	0591, 0741, 0790, 0801, 0869, 1526
				JNC .....	0672	Lifetec .....	0651, 0831, 1347
				JSI .....	1423	Limit .....	0768, 0716, 1104
				JVC .....	0503, 0539, 0558, 0623, 0867, 1164, 1241, 1275, 1597, 1602	LiteOn .....	1058, 1158, 1416, 1440, 1656, 1738
				jWin .....	1049, 1051		
				Kansai .....	1107		



Lodos .....	0713	0783, 0879, 1006,	Neufunk .....	0665	Packard Bell .....	0831
Loewe .....	0539, 0741, 0511,	1107, 1165, 1270,	NeuNeo .....	0509, 1454	Palladium .....	0695, 0713, 0779
	0885	1345, 1347, 1423	Nevir .....	0770, 0831, 1197	Palsonic.....	0672, 0835, 0852,
Logik .....	0713, 0884	MEI .....	Next Base .....	0826		1056, 1321
Logix .....	0705, 0783	Memorex .....	NexxTech .....	1402	Panasonic .....	0503, 0490, 0571,
Luker .....	1367		NFREN .....	0826		0632, 0703, 1010,
Lumatron.....	0741, 0695, 0705,	Metronic .....	Nikenny.....	1089		1011, 1282, 1362,
	0713, 0833, 1115,	0690	Nintaus.....	1051		1462, 1490, 1579,
	1321	Metz.....	Norcent.....	1003, 0719, 0872,	Panda .....	1762, 1641
Lunatron.....	0741	Micromedia.....		1107, 1265, 1457		0717, 0789
Luxman .....	0573	Micromega .....	Nordmende ....	0831, 1316	Paramount Picts	0779
Luxor .....	0713, 1004, 1730	0539, 1005	Noriko .....	0752	peeKTon .....	0898, 1224
Magnasonic ....	0651, 0675, 0769	Microsoft .....	Nowa.....	0843	Philco .....	0790, 0690, 0788,
Magnavox .....	0503, 0539, 0646,	0522, 1708, 2083	Nu-Tec .....	0516, 1228		0862
	0675, 0713, 0821,	Microstar .....	Okano .....	0752	Philips.....	0503, 0539, 0646,
	0885, 1140, 1177,	0831	Olidata .....	0672		0675, 0854, 0885,
	1268, 1472, 1506	Minato .....	Omni .....	0690, 0698, 0778,		1158, 1260, 1267,
Magnex .....	0723, 1165, 1489	Minax .....		0782, 0833, 0838,		1340, 1354, 1506,
Magnum .....	1436	Minerva.....		0862, 1104		1755, 2056
Majestic.....	1107, 1345	Minoka .....	Onix .....	0838	Philo .....	1345
Malata .....	0782, 1159	Minowa .....	Onkyo .....	0503, 0627, 0792,	Phonotrend .....	0699, 1165, 1177
Manhattan .....	0705, 0713	Mintek .....		1417, 1418, 1612,	PianoDisc .....	1024
Marantz .....	0503, 0539, 0675,	Mirror .....		1627	Pioneer .....	0490, 0525, 0571,
	1627	Mitsubishi.....	Oopla .....	1158		0142, 0631, 0632,
Mark .....	0713	1521, 0521, 0713,		1224, 1525		0638, 1460, 1531,
Marquant.....	0770	1403	Oppo.....	0843		1571, 1900
Matsui .....	0672, 0651, 0695,	Mizuda .....	Optim .....	0525, 0571	Playgo .....	1265
	0713, 0884, 1004,	1451	Optimus .....	0896	Plu2 .....	0850
	1316, 1730	Momitsu .....	OptoMedia Elec.	0818	Pointer.....	0784
Maxdorf.....	0788	1082		0818	Polaroid.....	1020, 1061, 1086,
Maxent .....	1347	Monyka .....	Orava .....	0872		1245, 1316, 1478,
Maxim .....	0713, 0872, 1242,	MPX.....	Orbit .....	0872		1480, 1482
	1367	0843	Orion .....	0695, 1128, 1233,	Polk Audio.....	0539
Maya .....	1345	MTlogic.....		1419	Portland.....	0770
MBO.....	0730, 0690, 1730	Mustek .....	Oritron.....	0651	Powerpoint.....	0758, 0872, 1005
McIntosh.....	1533, 1273	0730, 1730	Ormond .....	0713	Presidian .....	0675, 1072, 1738
MDS.....	0713, 0778	Mx Onda.....	Otic .....	0826, 1455	Prima .....	0766, 1016, 1228
Mecotek .....	0770	0651, 0751, 1223	P&B.....	0818, 1451	Prima Elec .....	0766
Medion .....	0651, 0630, 0831,	Myryad .....	Pacific .....	0695, 0831, 0768,	Primare.....	1467
	0652, 0716, 0758,	0894		0790, 0713, 0759,	Princeton .....	0674
		0831		0804	Prinz .....	0831
		Nesa .....				
		0717, 1603				

Prism .....	0831, 0705, 1089	1051, 1177, 1227, 1446	SEG.....	0798, 0665, 0713, 0763, 0872, 0884, 1173, 1483, 1530	Sony .....	0533, 1533, 0864, 0573, 0630, 1017, 1033, 1069, 1070, 1431, 1432, 1433, 1516, 1536, 1548, 1633	
Pro2.....	1107, 1345	Rocksonic .....	0789	Semp.....	0503	Sound Color .....	1233
ProCaster .....	1004	Ronin .....	0710, 0872	Sensory Science	1158	Sound Mobile...	1298
Proceed .....	0672	Rotel .....	0558, 0623, 1178	Shanghai.....	0672	Soundmaster....	0768
Proline .....	0672, 0651, 0710, 0833, 1004, 1068, 1483	Rowa .....	0717, 0516, 0759, 0823, 0872, 1004	Sharp .....	0630, 0675, 0713, 0752, 1256, 1419, 1642	Soundmax .....	0768
Proscan .....	0522	Rownsonic .....	0789	Sharper Image .	1117	Soundwave .....	0783
Proson .....	0713	S&V.....	1165	Sherwood.....	0717, 0741, 0770, 0633, 1043, 1077	Sova .....	1122
Prosonic .....	0699, 0752, 1169, 1441	Saba .....	0651, 0551, 0769	Shinco .....	0717, 1472	Spectra.....	0872
ProVision .....	0730, 0699, 0778, 1107, 1163, 1321	Saivod .....	0831, 0759, 1367	Shinsonic .....	0533, 0839	Standard.....	0651, 0831, 0768, 0788, 0898
Pye .....	0539, 0646	Salora .....	0741, 1446	Siemssen .....	1382	Star Clusters.....	1152, 1227
QONIX .....	1051, 1177	Sampo .....	0698, 0752, 1321, 1347, 1501	Sigma Designs.	0674	Starlogic .....	1005
Qwestar.....	0651	Samsung .....	0490, 0573, 0744, 0199, 0820, 0899, 1044, 1075, 1635	Sigmatek.....	1005, 1224	Starmedia .....	0818, 1005, 1224
Radionette.....	0741, 0869	Sansui .....	0784, 0695, 0768, 0716, 0751, 0763, 1051, 1228, 1230, 1316	Siltex .....	1224	Stevison.....	1367
RadioShack.....	0571	Santosh .....	1115	Silva .....	0788, 0898	Strong .....	0713
Raite .....	0665	Sanyo .....	0695, 0670, 0675, 0713, 0873, 1228, 1334	Silva Schneider	0831, 0898	Sungale .....	1074, 1532
RCA.....	0522, 0571, 0717, 0790, 0769, 0822, 1013, 1022, 1132, 1193, 1769	Santosha .....	1115	SilverCrest.....	1152	Sunkai .....	0770, 0850
Realistic .....	0571	Schaub Lorenz .	0770, 0788, 1115, 1151, 1165	Simaudio.....	0885	Sunstech .....	0831, 1072
REALmagic .....	0674	Schneider .....	0539, 0646, 0651, 0831, 0790, 0705, 0713, 0779, 0783, 0788, 0804, 0869, 1367	Singer .....	0768, 0690, 0716, 0751	Sunwood .....	0788, 0898
REC .....	0490, 0766	Scan .....	0705, 0835, 0850	Sinudyne .....	1316	Superscan .....	0821
Recco .....	0698	ScanMagic .....	0730, 1730	Sistemas .....	0672	Supervision.....	0768, 1152
Redstar.....	1003, 0770, 0759, 0763, 0788, 0898, 1107, 1345	Schaub Lorenz .	0770, 0788, 1115, 1151, 1165	Skantic .....	0539, 1003, 0713	Supratech .....	0893
Relisys.....	1347	Schneider .....	0539, 0646, 0651, 0831, 0790, 0705, 0713, 0779, 0783, 0788, 0804, 0869, 1367	Skymaster .....	0730, 0768	SVA.....	0672, 0717, 0752, 0860, 1105
Reoc.....	0768, 0752	Schwaiiger .....	0752	Skysonic .....	0766	Sylvania.....	0630, 0675, 0821, 1268
Revoy .....	0699, 0841	Scientific Labs .	0768	Skyworth.....	0766, 0898	Symphonic .....	0675, 0821, 1268, 1334
Rex .....	0838	Scott .....	0672, 0651, 1005, 1036, 1233, 1423	Sliding .....	1115	Synn .....	0768
Richmond.....	1233	Seeltech.....	1224, 1451	Slim Art .....	0784	TAG McLaren....	0894
Rio .....	0869			SM Electronic...	0730, 0768, 0690, 1152	Tandberg .....	0713
RJTech .....	1360			Smart .....	0705, 0713	Tangent.....	1321
Roadstar.....	0672, 0730, 0690, 0699, 0713, 0818, 0833, 0879, 0898,			Sonai .....	0755	Targa .....	1227
				Sonashi .....	0831, 0716	Tatung .....	0770
				Sonic Blue.....	0573, 0715, 0783, 0869, 1099	Tchibo .....	0741

TCM ..... 0741, 0790  
 Teac..... 0571, 0717, 0741,  
 0768, 0790, 1483,  
 1227, 1197, 1165,  
 1006, 0833, 0809,  
 0759, 0758, 0692,  
 0675, 0516  
 Tec..... 0898  
 Technica..... 1367  
 Technics ..... 0490, 0703  
 Technika..... 0770, 0831, 1115,  
 1165, 1489  
 Technissson ..... 1115  
 Technosonic..... 0730, 1051, 1115  
 Techwood..... 0692, 0713, 1530  
 Tedalex..... 0768, 0690, 1004,  
 1228  
 Telefunken..... 0790, 0758, 0789,  
 0833, 1483  
 Teletech..... 0768, 0713  
 Tensai ..... 0651, 0770, 0690  
 Terapin ..... 1031  
 Tevion ..... 0651, 0798, 0768,  
 0652, 0833, 0898,  
 1036, 1227, 1347,  
 1382, 1483, 1730  
 Theta Digital .... 0571  
 Thomson ..... 0522, 0551, 0511  
 Tiny ..... 1489  
 Tivo ..... 1503, 1588  
 Tokai ..... 0784, 0790, 0665,  
 0698, 0788, 0898  
 Tokaido..... 0698  
 Tokiwa ..... 0716  
 Tom-Tec ..... 0789  
 Top Suxess ..... 1224  
 Toshiba..... 0503, 0573, 0539,  
 0695, 1045, 1154,  
 1503, 1510, 1588,  
 1769  
 Trans Continens 0826

TRANS-contrs .. 0831, 0826, 0872,  
 1165, 1321, 1327  
 Transonic ..... 0730, 1165  
 Tredex ..... 0799, 0800, 0803,  
 0804, 0843  
 TruVision ..... 0857, 1451  
 TSM..... 1224  
 TYT..... 0705  
 Umax ..... 0690, 1151  
 Unimax ..... 0770  
 United ..... 0695, 0730, 1489,  
 1446, 1367, 1351,  
 1228, 1173, 1165,  
 1152, 1115, 1072,  
 0884, 0826, 0788,  
 0713, 0699, 0675  
 Universum ..... 0591, 0741, 0790,  
 0713, 0779, 0869,  
 1227, 1530  
 Uptek ..... 0763  
 upXus ..... 1345  
 Urban Concepts 0503, 0539  
 US Logic..... 0839  
 V ..... 1064, 1126, 1226  
 Valor ..... 1298  
 Venturer ..... 0790  
 Vestel ..... 0713, 0884, 1530  
 Vialta ..... 1509  
 Victor ..... 1241, 1597  
 Vieta ..... 0705, 1265  
 Viewmaster..... 0862, 1224  
 Vizio ..... 1064, 1126, 1226  
 Vocopro ..... 1027, 1360  
 Voxson ..... 0730, 0831, 0690  
 Vtrek ..... 1228  
 Waitec ..... 1151, 1224, 1233  
 Walkvision ..... 0717  
 Waltham ..... 1530  
 Welkin ..... 0831  
 Wellington..... 0713

Weltstar..... 0713  
 Wesder ..... 0699  
 Wharfedale..... 0790, 0698, 0751,  
 0752  
 Wilson ..... 0831, 1233  
 Windsor..... 0713  
 Windy Sam .... 0573  
 WIZE ..... 1115  
 Woxter ..... 1005, 1151, 1224  
 Xbox..... 0522, 1708, 2083  
 Xenius ..... 0790  
 XLogic ..... 0768, 1152, 1228  
 XMS ..... 0770, 0788  
 Xoro ..... 1173, 1183  
 Xwave ..... 1001  
 Yakumo ..... 0652, 1004, 1056  
 Yamada ..... 0652, 0872, 1004,  
 1056, 1151, 1158,  
 1416, 1489  
 Yamaha ..... 0490, 0539, 0646,  
 0545, 1282, 1354  
 Yamakawa ..... 0665, 0710, 0872,  
 1104, 1489  
 Yukai ..... 0730, 1730  
 Zenith ..... 0503, 0591, 0741,  
 0869  
 Zennox ..... 1265  
 Zeus..... 0784  
 Zoece ..... 1265

### VCR

A-Mark ..... 0037, 0240, 0000,  
 0278, 0046  
 ABS..... 1972  
 Accent ..... 0072

Admiral ..... 0060, 0048, 0039,  
 0047, 0104, 0121,  
 0209, 0020, 0062,  
 0065, 0479  
 Adventura ..... 0037, 0240, 0000  
 Adyson ..... 0072  
 Aiko ..... 0278  
 Aim ..... 0278, 0348, 0642,  
 0020  
 Aiwa ..... 0037, 0032, 0000,  
 0209, 0041, 0348,  
 0307, 0352, 0124,  
 0479, 0742, 1137,  
 1284, 1291, 1332,  
 1336  
 Akai ..... 0037, 0240, 0041,  
 0348, 0642, 0352,  
 0315, 0020, 0053,  
 0061, 0175, 0242  
 Akiba ..... 0072  
 Akitan ..... 0295  
 Akura ..... 0041, 0072, 0271  
 Alba ..... 0081, 0000, 0209,  
 0072, 0278, 0348,  
 0352, 0315, 0020,  
 0295  
 Alienware ..... 1972  
 Allegro ..... 0039, 1137  
 Allorgan ..... 0240  
 Allstar ..... 0081  
 Ambassador..... 0020  
 America Action 0278  
 American High.. 0035, 0081  
 Amoisonic ..... 0479  
 Amstrad..... 0000, 0072, 0278  
 Anam ..... 0162, 0037, 0240,  
 0278, 0579, 1037  
 Anam National.. 0162, 1562, 0454,  
 0579, 1162  
 Anitech ..... 0072  
 Ansonic ..... 0000

DVD

VCR

Arion .....	1787	Broksonic .....	0184, 0121, 0209, 0002, 0348, 0208, 0211, 0295, 0361, 0479, 1479, 1815	Crosley.....	0035, 0081, 0000, 0149, 0110	Dual.....	0081, 0000, 0041, 0278, 0348
Aristona.....	0081	Bush .....	0081, 0000, 0209, 0072, 0278, 0348, 0642, 0352, 0315, 0742	Crown .....	0037, 0072, 0278, 0020, 0271	Dumont .....	0081, 0000, 0104, 0105
ASA.....	0037, 0081	Calix .....	0037	Curtis Mathes ..	0060, 0035, 0162, 0240, 0000, 0041, 0278, 0432, 0277, 0454, 0643, 0760, 1035	Durabrand .....	0039, 0038, 0642, 0593
Asha.....	0240	Candle .....	0037, 0038	Cybernex .....	0240, 0051	Dynatech .....	0240, 0000
Astra .....	0035, 0240, 0051	Canon .....	0035, 0034	CyberPower.....	1972	Elbe .....	0278, 0038
Asuka .....	0037, 0081, 0000, 0072, 0038	Capehart.....	0002, 0020, 0062	Cyrus .....	0081	Elcatech .....	0072
Audio-Technica	0058	Carena .....	0081, 0209	Daewoo .....	0037, 0045, 0104, 0209, 0278, 0642, 0352, 0020, 0046, 0210, 0212, 0368, 0561, 0844, 1137, 1278	Electrohome.....	0060, 0037, 0240, 0000, 0043, 0209, 0061
Audiolab.....	0081	Carrefour .....	0045	Dansai .....	0072, 0278	Electroponic ...	0037
Audiosonic .....	0278	Carrera.....	0240	Dantax .....	0352	Elin .....	0240, 0051
Audioton.....	0020	Carver .....	0035, 0081	Daytron .....	0037, 0278, 0020	Elsay .....	0072
Audiovox .....	0037, 0278, 0038, 0054	Casio .....	0000	De Graaf.....	0048, 0081, 0042, 0104, 0046	Elta .....	0072, 0278
AVA Tech. ....	0615	Cathay .....	0278	Decca .....	0081, 0000, 0067, 0209, 0041, 0352, 0008	Emerald .....	0184, 0121, 0211
Avis .....	0000, 0072	Catron .....	0020	Degraff .....	0048, 0081, 0042, 0104	Emerex .....	0032
AVP .....	0000, 0352	CCE .....	0072, 0278	Deitron .....	0278	Emerson .....	0035, 0037, 0184, 0039, 0240, 0045, 0000, 0121, 0043, 0209, 0072, 0002, 0278, 0348, 0561, 0510, 0593, 0479, 0378, 1278, 1479, 0361, 1593, 0343, 0295, 0294, 0212, 0211, 0208, 0202, 0088, 0068, 0061, 0036
Awa .....	0037, 0043, 0278, 0642, 0075, 0579	Centrum.....	0593	Dell.....	1972	ESA .....	1137
Baird .....	0000, 0104, 0041, 0278, 0046	CGE .....	0000, 0041	Denko .....	0072	ESC .....	0240, 0278, 0020
Basic Line .....	0104, 0072, 0278, 0020, 0046	Changhong .....	0048, 0081	Denon .....	0081, 0042	EuroLine .....	1593
Beaumar.....	0240	Cimline .....	0209, 0072	Derwent .....	0041	Europhon.....	0020
Beko.....	0104	Cineral .....	0278	Diamant .....	0037	Fenner .....	0020
Bell & Howell....	0035, 0048, 0039, 0000, 0104, 0046, 0479	CineVision.....	1137	Diamond .....	0348	Ferguson .....	0000, 0041, 0278, 0348, 0320, 0053
Bestar .....	0278, 0020	Citizen .....	0035, 0037, 0240, 0000, 0209, 0278, 0036, 0479, 1278	Dick Smith Elec	0642, 0579	Fidelity.....	0240, 0000, 0072, 0352, 0432
Black Diamond.	0642	Classic.....	0037	Digitor .....	0642, 0579	Finlandia .....	0037, 0048, 0081, 0000, 0042, 0104,
Black Panther...	0278	Clatronic .....	0000, 0072, 0020, 1593	DiracTV .....	0739, 2033		
Blaupunkt .....	0162, 0081, 0034, 0227, 0513	Colortyme .....	0060, 0035, 0045, 0278	Domland .....	0209		
Blue Sky.....	0037, 0209, 0072, 0278, 0348, 0642, 0352, 0742, 1137	Combitech .....	0352	DSE.....	0642, 0579		
Bondstec.....	0072, 0020	Condor .....	0278, 0020				
BPL .....	0046	Craig .....	0037, 0047, 0240, 0072, 0271				
Brandt .....	0041, 0320	Criterion .....	0000, 0072				
Brandt Elec. ....	0041						
Brinkmann .....	0209, 0348						

	0043, 0384, 0046, 0110	GoldStar .....	0035, 0037, 0039, 0000, 0209, 0278, 0038, 0018, 0054, 0225, 1137, 1237	Hischito .....	0045	JMB .....	0209, 0348, 0352, 0742
Finlux .....	0081, 0000, 0042, 0104, 0105			Hitachi .....	0035, 0037, 0081, 0240, 0045, 0000, 0042, 0041, 0384, 1326, 1286, 1037, 0593, 0544, 0105, 0089, 0082, 0065, 0046	Joyce .....	0000
Firstline .....	0037, 0045, 0042, 0043, 0209, 0072, 0278, 0348, 0088, 1137	Goodmans .....	0037, 0081, 0240, 0000, 0209, 0072, 0278, 0348, 0642, 0352, 0020, 0062, 0343, 0579, 0742			JVC .....	0184, 0081, 0045, 0067, 0041, 0384, 1707, 1329, 1299, 1283, 1279, 1162, 0486, 0366, 0207, 0061, 0058, 0008
Fisher .....	0039, 0047, 0000, 0104, 0020, 0046, 0054, 0066	GPX .....	0037	Hoehner .....	0278, 0642	Kaisui .....	0072
Flint .....	0209, 0348	Gradiente .....	0000, 0008, 1137	Hornophon .....	0081	Kambrook .....	0037
Frontech .....	0072, 0020	Graetz .....	0240, 0104, 0041	Howard Comps .....	1972	Karcher .....	0081, 0278, 0642
Fuji .....	0035, 0033	Granada .....	0035, 0037, 0048, 0081, 0240, 0000, 0042, 0104, 0011, 0046	HP .....	1972	Kathrein .....	1802, 1868, 1869, 1870
Fujitsu .....	0037, 0045, 0000, 0366			Hughes Net Sys .....	0042, 0739	KEC .....	0037, 0278
Fujitsu General .....	0037	Grandin .....	0037, 0000, 0209, 0072, 0278, 0020, 0742	Humax .....	0739, 1711, 1845, 1853	Keen .....	0693
Funai .....	0037, 0000, 0072, 0278, 0294, 0593, 1333, 1593	Grundig .....	0081, 0072, 0348, 0320, 0352, 0034, 0207, 0347, 0378, 0742	Hush .....	1972	Kendo .....	0037, 0209, 0072, 0278, 0348, 0642, 0315, 0053
Galaxi .....	0000			Hypson .....	0037, 0000, 0209, 0072, 0278, 0352	Kenwood .....	0067, 0041, 0038, 0384, 0046
Galaxis .....	0278	Haaz .....	0348	Hytek .....	0047, 0000, 0072, 0036	KIC .....	0000
Garrard .....	0000	Hanimex .....	0352, 0295	iBUYPOWER ... ..	1972	Kimari .....	0047
Gateway .....	1972	Hanseatic .....	0037, 0081, 0209, 0038	Imperial .....	0000	Kimari .....	0047
GBC .....	0020	Hantor .....	0020	Ingersol .....	0240, 0209	Kioto .....	0348
GE .....	0060, 0035, 0048, 0240, 0000, 0149, 0320, 0065, 0077, 0202, 0277, 0760, 0761, 0807, 1035, 1060	Haojie .....	0240	Inno Hit .....	0072, 0020	KLH .....	0072
GEC .....	0081	Harley Davidson .....	0000	Interbuy .....	0037, 0072	Kneissel .....	0037, 0209, 0278, 0348, 0352
Gemini .....	0060	Harman/Kardon .....	0081, 0038, 0075	Interfunk .....	0081, 0104	Kodak .....	0035, 0037
General .....	0045, 0020, 0366	Harvard .....	0072, 0068	Internal .....	0278	Kolin .....	0043, 0041
General Technic .....	0348	Harwood .....	0072, 0068	International .....	0037, 0278, 0642	Kolster .....	0209
Genexxa .....	0037, 0000, 0104, 0278	HCM .....	0072	Intervision .....	0037, 0000, 0209, 0278, 0348	Korpel .....	0072
Go Video .....	0240, 0432, 0232, 0526, 0614, 0643, 1137	Headquarter .....	0046	Irradio .....	0037, 0081, 0072, 1137	KTV .....	0000
GoldHand .....	0072	Hewlett Packard .....	1972	ITT .....	0240, 0104, 0041, 0384, 0046, 0378	Kuba .....	0047
		HI-Q .....	0035, 0047, 0000	ITT Nokia .....	0240, 0104, 0041	Kuba Electronic .....	0047
		Hinari .....	0240, 0209, 0041, 0072, 0278, 0352, 0088, 0208, 0343	ITV .....	0037, 0278, 0020	Kyoto .....	0072
		Hisawa .....	0209, 0352	Janeil .....	0240	Lenco .....	0278
				JBL .....	0278	Leyco .....	0072
				Jensen .....	0067, 0041	LG .....	0037, 0240, 0045, 0000, 0042, 0209, 0278, 0038, 0051,

	0053, 0225, 1037, 1137, 1237	Master's.....	0278		0642, 1343, 0807, 0443, 0242, 0214, 0173, 0075, 0061	Nu-Tec .....	0209
Lifetec .....	0209, 0348	Matsui .....	0037, 0240, 0209, 0278, 0348, 0352, 0036, 0088, 0208, 0295, 0742	Motorola.....	0035, 0048	Oceanic.....	0048, 0081, 0000, 0104, 0041, 0046
Linksys .....	1972			Movie Walker ...	0072	Okano .....	0209, 0072, 0278, 0348, 0315
Lloyd's .....	0240, 0000, 0072, 0038, 0036, 0208	Matsushita.....	0035, 0162, 0081, 0227, 0367, 0454, 1162	MTC .....	0240, 0000, 0072	Olympus.....	0035, 0162, 0104
Loewe .....	1062, 0162, 0037, 0081, 1562, 0105, 0454, 1262	Media Center PC	1972	MTX .....	0000	Onimax .....	0642
Logik .....	0240, 0000, 0209, 0072, 0011	Mediator .....	0081	Multitec.....	0037	Onkyo .....	0222
Luker .....	0579	Medion .....	0209, 0348, 0642, 0352	Multitech .....	0039, 0000, 0072, 0020	Optimus.....	1062, 0035, 0162, 0037, 0048, 0047, 0240, 0000, 0104, 0432, 0062, 0058, 0054, 0454, 0593, 1048, 1162, 1262
Lumatron.....	0278, 0593, 1137	MEI .....	0035	Murphy .....	0000	Optonica.....	0062
Lunatron.....	1137	Memorex .....	0035, 0162, 0037, 0048, 0039, 0047, 0240, 0000, 0104, 0209, 0072, 0278, 0348, 0307, 0569, 1262, 1237, 1162, 1048, 1037, 0579, 0479, 0454, 0046, 0062, 0054	Myryad .....	0081	Orbit .....	0072
Lux May .....	0072			NAD .....	0240, 0104, 0058	Orion .....	0184, 0240, 0000, 0104, 0121, 0209, 0002, 0278, 0348, 0352, 1815, 1479, 0742, 0479, 0343, 0295, 0294, 0211, 0208, 0088, 0036
Luxor .....	0048, 0047, 0104, 0043, 0072, 0315, 0046, 0062	Memphis.....	0072	Naiko .....	0348, 0642	Orson .....	0000
LXI .....	0037, 0000, 0042, 0067, 0054	Mercury .....	0020	NAP .....	0039	Osaki .....	0037, 0000, 0072
M Electronic.....	0037, 0240, 0000, 0038	Metronic .....	0081	Nebula Elec. ....	0033	Osume .....	0072
Magnadyne .....	0081, 0212	Metz.....	1062, 0162, 0037, 0081, 1562, 0227, 0347, 0454, 0836, 1162, 1262	NEC .....	0035, 0037, 0048, 0104, 0067, 0041, 0278, 0038, 0008, 0082, 0370, 1137, 1287, 1288	Otake .....	0209
Magnasonic .....	0037, 0240, 0000, 0072, 0278, 0020, 0082, 0593, 1278	MGA .....	0060, 0240, 0043, 0061	Neckermann ....	0081, 0041, 0208	Otto Versand ....	0081
Magnavox .....	0035, 0037, 0048, 0039, 0081, 0240, 0000, 0149, 0642, 1781, 1593, 0618, 0593, 0563, 0110, 0054, 0011	MGN Tech. ....	0240	Nesco .....	0000, 0072	Pace .....	0352
Magnin .....	0240	Micormay.....	0348	New Funk .....	0209	Pacific .....	0000, 0348, 0642, 0742
Magnum .....	0642	Micromaxx .....	0209	New Tech .....	0072	Packard Bell.....	1972
Manesth .....	0081, 0045, 0209, 0072	Microsoft .....	1972	Newave .....	0037	Palladium .....	0037, 0209, 0041, 0072, 0348
Marantz .....	0035, 0081, 0209, 0038, 0062, 0295, 1381	Midland.....	0240, 0051	Nikkai .....	0072, 0278, 0020	Palsonic.....	0000, 0072, 0642
Mark.....	0000, 0278, 0020	Migros .....	0000	Nikko .....	0037, 0278	Panama .....	0035
Marta .....	0037	Mind .....	1972	Nikkodo .....	0037, 0278	Panasonic .....	1062, 0035, 0162, 0000, 1562, 1807, 1393, 1317, 1308, 1293, 1292, 1262, 1244, 1162, 1035, 0836, 0616, 0615,
Mastec .....	0642	Minolta.....	0042, 0105	Nikon .....	0011, 0034		
		Mitsubishi.....	0060, 0048, 0047, 0081, 0000, 0042, 0067, 0043, 0041,	Nishi .....	0240		
				Niveus Media...	1972		
				Noblex .....	0240		
				Nokia .....	0048, 0081, 0240, 0042, 0104, 0041, 0278, 0315, 0036, 0046, 0378		
				Nordmende .....	0067, 0041, 0320, 0384, 0207		
				Northgate .....	1972		

	0614, 0513, 0454, 0378, 0367, 0246, 227, 0225, 0077, 0051, 0020	Protech..... 0081, 0072	Rex..... 0041, 0384	Schneider ..... 0037, 0081, 0240, 0000, 0042, 0072, 0278, 0348, 0642, 0352, 0110, 1137
Pathe Cinema ..	0043, 0036	ProVision ..... 0278	RFT ..... 0072, 0020	Scientific Atlanta 0008
Pathe Marconi..	0041	Pulsar ..... 0039, 0240, 0278, 0051	Ricavision ..... 1972	Scott ..... 0184, 0045, 0121, 0043, 0036, 0208, 0210, 0211, 0212, 0593
Penney .....	0035, 0162, 0037, 0047, 0081, 0240, 0000, 0042, 0067, 0038, 0054, 0077, 1035, 1237	Pulser ..... 0240, 0051	Ricoh ..... 0034	Sears ..... 0060, 0035, 0162, 0037, 0048, 0039, 0047, 0033, 0045, 0000, 0042, 0104, 0067, 0043, 0209, 0041, 0072, 1237, 0105, 0066, 0065, 0011, 0058, 0054, 0018, 0034, 0046, 0036
Pentax .....	0042, 0065, 0105	Pye ..... 0081, 0000	Rio ..... 1137	Seaway ..... 0278
Perdio .....	0000, 0209	Qisheng ..... 0060	Roadstar ..... 0037, 0081, 0240, 0072, 0278, 0038, 0742	SEG ..... 0081, 0240, 0072, 0278, 0642, 0561
Philco .....	0035, 0081, 0000, 0209, 0072, 0038, 0110, 0479, 0561	Quarter ..... 0046	Royal ..... 0072	SEI..... 0081
Philips .....	0035, 0162, 0048, 0081, 0045, 0000, 0209, 0384, 0110, 0062, 0034, 0563, 0593, 0616, 0618, 0739, 1081, 1181, 1381	Quartz ..... 0035, 0047, 0046	Runco ..... 0039	Sei-Sinudyne.... 0081
Phoenix .....	0278	Quasar ..... 0035, 0162, 0002, 0278, 0077, 0454, 1035, 1162	Saba..... 0041, 0278, 0320, 0384, 0062, 0207	Seleco ..... 0037, 0041, 0384, 0008, 0020
Phonola.....	0081	Quelle ..... 0081, 0208	Saisho ..... 0209, 0348, 0036, 0088, 0208	Semivox ..... 0045, 0209
Pilot .....	0037	Questar..... 0020	Salora ..... 0104, 0043, 0046, 0075, 0443	Semp ..... 0045
Pioneer.....	0162, 0081, 0042, 0067, 0058, 1337, 1388, 1390	Radialva..... 0037, 0048, 0081, 0072	Sampo ..... 0037, 0048	Sentra ..... 0072, 0278, 0020
Polk Audio.....	0081	Radiola ..... 0081	Samsung..... 0060, 0240, 0045, 0000, 0038, 0432, 0051, 0053, 0077, 0210, 0212, 0739, 0760, 1014	Setron ..... 0072
Portland ..... 0278, 0020		Radionette..... 0037, 1137	Samtron ..... 0240, 0643	Sharp ..... 0037, 0048, 0047, 0032, 0000, 0209, 0569, 0062, 0065, 0363, 0807, 0848, 1048, 1285, 1400, 1815
Precision ..... 0058		RadioShack..... 0035, 0162, 0037, 0048, 0047, 0240, 0000, 0104, 0046, 0062, 0066, 1037, 1162	Samurai..... 0020	Shinco ..... 0000
Presidian ..... 1593		Radix ..... 0037	Sanky ..... 0048, 0039	Shintom..... 0039, 0240, 0000, 0104, 0072, 0208
Prinz ..... 0000, 0088		Randex ..... 0037	Sansei ..... 0048	Shivaki..... 0037
Profitronic..... 0081, 0240		Rank ..... 0041	Sansui ..... 0240, 0000, 0067, 0209, 0041, 0072, 0002, 0348, 0082, 0271, 0479, 1479	Shogun ..... 0240, 0051
Proline..... 0000, 0278, 0642, 0320, 0615		Rank Arena..... 0041	Sanyo ..... 0048, 0047, 0240, 0000, 0104, 0067, 0209, 0348, 0046, 0159, 0368, 0369, 0479, 1137, 1330, 1331	Shorai ..... 0088
Proscan..... 0060, 0202, 0760, 0761, 1060		RCA..... 0060, 0035, 0048, 0240, 0045, 0000, 0042, 0149, 0320, 0065, 0077, 0105, 0058, 0202, 0211, 0054, 0277, 0760, 0761, 0807, 0880, 1035, 1060	Saville ..... 0240, 0278, 0352	
Proscow ..... 0278, 0844		Realistic ..... 0035, 0162, 0037, 0048, 0047, 0240, 0000, 0104, 0121, 0278, 0046, 0062, 0065, 0066, 1162	SBR..... 0081	
Prosonic..... 0209, 0278		Reoc ..... 0348	ScanSonic ..... 0240	
Protec ..... 0000, 0072		ReplayTV..... 0614, 0616	Schaub Lorenz. 0000, 0104, 0041, 0348, 0315	

Siemens .....	0037, 0081, 0104, 0320, 0046, 0054, 0347, 0510	Sunstar .....	0000	Tedalex.....	0037, 0209, 0348, 0642		1290, 1289, 1145, 1008, 0845, 0828, 0742, 0544, 0366, 0212, 0210, 0066, 0062, 0054, 0008	
Siera .....	0081	Suntronic .....	0000	Teknika.....	0035, 0037, 0000			
Signature .....	0060, 0035, 0037, 0048, 0000, 0149, 0046, 0065, 0066, 0479	Sunwood .....	0072	Teleavia.....	0041			
Silva .....	0037	Supra .....	0037, 0278, 0348	Telecorder .....	0240			
Silver .....	0278	Susumu .....	0037	Telefunken.....	0209, 0041, 0278, 0642, 0320, 0384, 0208, 0593		Tosonic.....	0278
SilverCrest.....	0642	SV2000 .....	0000, 0072	Telenet .....	1784		Totevision .....	0037, 0240
Singer .....	0037, 0240, 0045, 0072, 0348, 0271	SVA.....	0000	Telestar .....	0037		Touch .....	1972
Sinudyne .....	0081, 0209, 0352	Sylvania.....	0035, 0081, 0000, 0043, 0110, 0593, 1593, 1781	Teletech.....	0000, 0072, 0278		Towada .....	0072
Smaragd .....	0348	Symphonic .....	0240, 0000, 0002, 0593, 1593	Tempest .....	0020		Toyoda .....	0278
Solavox .....	0020, 0034	Systemax.....	1972	Tenosal.....	0072		Tradex .....	0081
Sonic Blue.....	0614, 0616, 0643, 1137	T+A.....	0162	Tensai .....	0037, 0000, 0072, 0278		Trakton .....	0020
Sonneclair .....	0072	Tagar Systems..	1972	Tevisai .....	0037, 0000, 0072, 0278		Triad .....	0278
Sonographe .....	0046	Taisho .....	0209, 0088	Tevion .....	0209, 0348, 0642, 0479		Triumph .....	0208
Sonolor.....	0048, 0046, 0062	Tandberg .....	0278	Texet .....	0278, 0020		Trix.....	0037
Sontec .....	0037, 0278	Tandy .....	0000, 0104	Thomas .....	0000, 0002		Uher.....	0240
Sonwa .....	0642	Tashiko .....	0037, 0048, 0081, 0240, 0000	Thomson.....	0060, 0067, 0041, 0278, 0320, 0384, 0202		Ultra .....	0045, 0278, 0020
Sony.....	0035, 0048, 0047, 0032, 0033, 0000, 0067, 1972, 1636, 1448, 1447, 1297, 1296, 1295, 1232, 1032, 0640, 0639, 0636, 0586, 0046, 0034, 0011	Tatung .....	0048, 0081, 0045, 0000, 0067, 0043, 0209, 0041, 0348, 0352, 0008, 0053, 0366	Thorn .....	0037, 0104, 0041, 0320, 0036, 0443		Ultravox.....	0278
Soundmaster ...	0000	Tchibo .....	0348	Tisonic .....	0278		Unitech.....	0240, 0051
Soundwave .....	0037, 0209, 0348	TCM.....	0348	Tivo .....	0618, 0636, 0739, 1337, 1996		United .....	0348, 0742, 1593
Ssangyong .....	0072	Teac.....	0037, 0000, 0067, 0041, 0072, 0278, 0307, 0642, 0526, 0593, 0844, 1593	TMK .....	0240, 0000, 0036, 0208		Universum .....	0037, 0081, 0240, 0000, 0104, 0209, 0348, 1137
Stack 9.....	1972	Tec.....	0072, 0020	TNIX .....	0037		Vector .....	0045
Standard .....	0278	Tech Line .....	0072	Tocom .....	0240		Vector Research	0184, 0038
Stern .....	0278	Technics .....	0035, 0162, 0037, 0081, 0000, 0246, 1162	Tokai .....	0037, 0104, 0041, 0072		Vextra .....	0072
Strong .....	0271	TechniSat .....	0348	Topfield .....	1959, 2045		Victor .....	0067, 0041, 0384, 0008, 0370, 1283, 1299
STS .....	0042, 0105	Technosonic .....	0352	Topline .....	0348		Video Concepts	0045, 0061, 0210, 0242
Sunkai .....	0209, 0278, 0348, 0295	Teco.....	0035, 0037, 0048, 0041, 0038	Toshiba .....	0081, 0240, 0045, 0000, 0042, 0067, 0043, 0209, 0041, 0384, 0352, 0432, 1384, 1386, 1972, 1325, 1323, 1996,		Video Pro .....	0020



Wards ..... 0060, 0035, 0037,  
0048, 0039, 0047,  
0081, 0033, 0240,  
0045, 0000, 0042,  
0043, 0041, 0072,  
0038, 0149, 0046,  
0058, 0018, 0062,  
0065, 0011, 0212,  
0479, 0760

Watson ..... 0081, 0642, 0352

Weltblick ..... 0037

Wharfedale..... 0642, 0593, 0615

White Westinghs 0000, 0209, 0072,  
0278, 0479

World ..... 0209, 0002, 0348,  
0479

XR-1000 ..... 0035, 0240, 0000,  
0072, 0208

Yamaha ..... 0041, 0038

Yamishi..... 0072, 0278

Yokan ..... 0072

Yoko ..... 0037, 0240, 0072,  
0020

Yoshita ..... 0072

Zenith ..... 0037, 0039, 0033,  
0000, 0209, 0041,  
0278, 0011, 0034,  
0479, 1137, 1139,  
1479

ZT Group..... 1972

ZX..... 0209, 0348, 0352

## A-ACC

Accurian ..... 2502

Altec Lansing ... 2500, 2501

Apple ..... 2503, 2505

DLO..... 2504, 2509

Griffin ..... 2508

iPort ..... 2506, 2507

NaviPod..... 2505

Sonance ..... 2506, 2507

TEN Technology 2505

## V-ACC

ABS ..... 1272

Accurian ..... 1653

Alienware ..... 1272

Amino ..... 1481

Axonix ..... 1447

Buffalo ..... 1739

CyberPower..... 1272

D-Link ..... 1554, 1731

Dgtec ..... 1363

Epson ..... 1563, 1650

Gateway ..... 1272

Hewlett Packard 1272, 1267

Howard Comps 1272

HP..... 1272, 1267

Hush ..... 1272

iBUYPOWER ... 1272

Keyspan ..... 1344

KoolConnect ... 1481

LG..... 1415

Linksys ..... 1272, 1365

Macro Image Tech.1383

Media Center PC 1272

Microsoft ..... 1272, 1805, 2049

Mind ..... 1272

Motorola ..... 1363

MyHD ..... 1383

Niveus Media.... 1272

Northgate ..... 1272

Packard Bell .... 1272

Panasonic ..... 1120

Philips ..... 1218

Pinnacle Systems 1447

Pioneer..... 1010

ReQuest..... 1245

Ricavision ..... 1272

Roku ..... 1486

Samsung..... 1190, 1490

Sensory Science 1126

Sharp ..... 1010

Sony..... 1272, 1324, 1364

Stack 9..... 1272

SureWest ..... 1481

Sylvania ..... 1563

Systemax ..... 1272

Tagar Systems . 1272

Toshiba ..... 1272

Touch ..... 1272

Viewsonic ..... 1272, 1329

Vizio ..... 1126

Voodoo ..... 1272

Xbox..... 1805, 2049

Zinwell..... 1363

ZT Group..... 1272

## R-ACC

Bose..... 1629





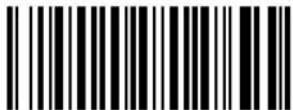

312515

***BOSE***<sup>®</sup>  
*Better sound through research*<sup>®</sup>

©2008 Bose Corporation, The Mountain,  
Framingham, MA 01701-9168 USA  
AM312515 Rev.01

## Free Manuals Download Website

<http://myh66.com>

<http://usermanuals.us>

<http://www.somanuals.com>

<http://www.4manuals.cc>

<http://www.manual-lib.com>

<http://www.404manual.com>

<http://www.luxmanual.com>

<http://aubethermostatmanual.com>

Golf course search by state

<http://golfingnear.com>

Email search by domain

<http://emailbydomain.com>

Auto manuals search

<http://auto.somanuals.com>

TV manuals search

<http://tv.somanuals.com>