

Professional Weather Center

model 01502BPDI

ACURITE®



Weather Stations



Temperature & Humidity



Weather Alert Radio



Kitchen Thermometers & Timers



Clocks



It's More than Accurate, it's ACURITE®.

AcuRite offers an extensive assortment of precision instruments, designed to provide you with information you can depend on to Plan your day with confidence™.

www.AcuRite.com

CONTENTS

Unpacking Instructions.....	2	5-in-1 Sensor Installation.....	11
Package Contents.....	2	Using the Weather Center.....	12
Product Registration.....	2	Programmable Alarms.....	12
Features & Benefits.....	3	Troubleshooting.....	14
Setup.....	6	Care & Maintenance.....	16
5-in-1 Sensor Setup.....	6	Calibration.....	16
Display Unit Setup.....	7	Specifications.....	18
Set the Time & Date.....	8	FCC Information.....	18
Measurement Units.....	9	Customer Support.....	19
Placement Guidelines.....	10	Warranty.....	19

Questions? Contact Customer Support at (877) 221-1252 or visit www.AcuRite.com.

SAVE THIS MANUAL FOR FUTURE REFERENCE.

Congratulations on your new AcuRite product. To ensure the best possible product performance, please read this manual in its entirety and retain it for future reference.

Unpacking Instructions

Remove the protective film that is applied to the LCD screen prior to using this product. Locate the tab and peel off to remove.

Package Contents

1. Display unit with tabletop stand
2. 5-in-1 sensor
3. Sensor mounting bracket
4. Mounting hardware
5. Snap-in debris filter for rain collector
6. Instruction Manual

IMPORTANT

PRODUCT MUST BE REGISTERED TO RECEIVE WARRANTY SERVICE

PRODUCT REGISTRATION

Register online to receive 1-year warranty protection

www.AcuRite.com

SHOP NOW

SUPPORT

Support Forum

Archived Products

▶ Register a Product

Features & Benefits

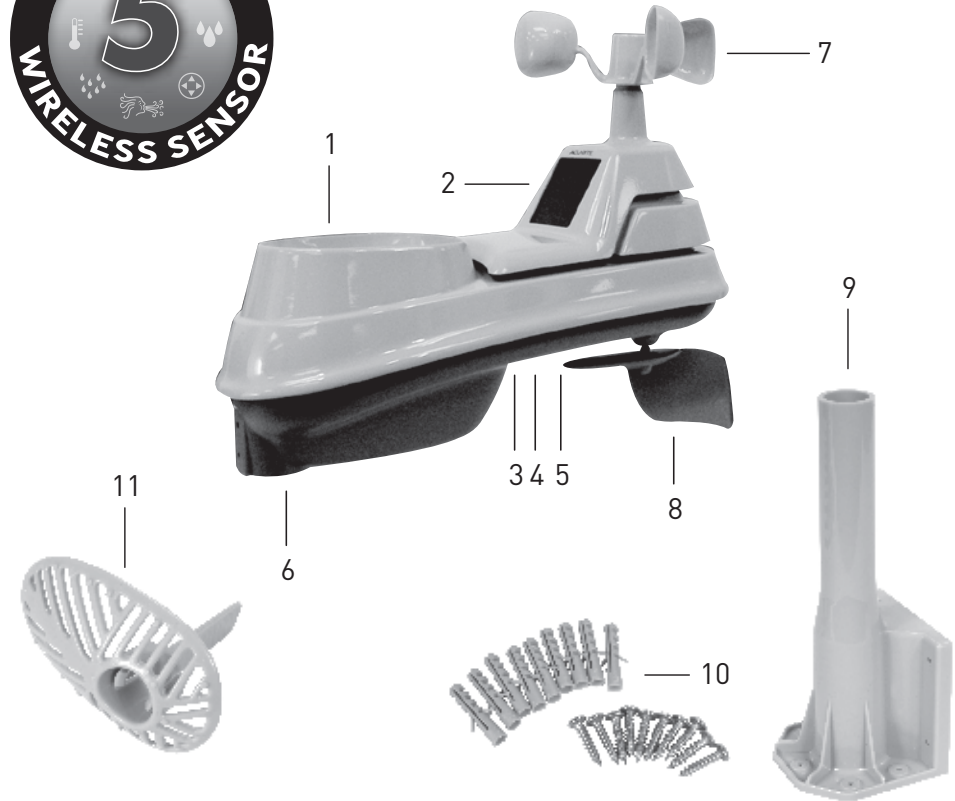

5-IN-1 SENSOR

1. Rainfall Collector Funnel

2. Solar Cell Panel

Converts sunlight into power to run internal aspirating fan.

Internal Aspirating Fan (not shown)

Draws ambient air into sensor to reduce solar radiation heating, resulting in more accurate temperature measurement.

3. A-B-C Switch

ID code that must match display's A-B-C switch to ensure units synchronize.

4. Battery Compartment

5. Temperature & Humidity Sensors (internal)

6. Mounting Point

7. Wind Speed Anemometer

8. Wind Direction Vane

9. Mounting Bracket

10. Mounting Hardware

Includes anchors and screws.

11. Debris filter

Snaps into rain collector to filter out twigs, leaves, etc.

Features & Benefits

Display Unit

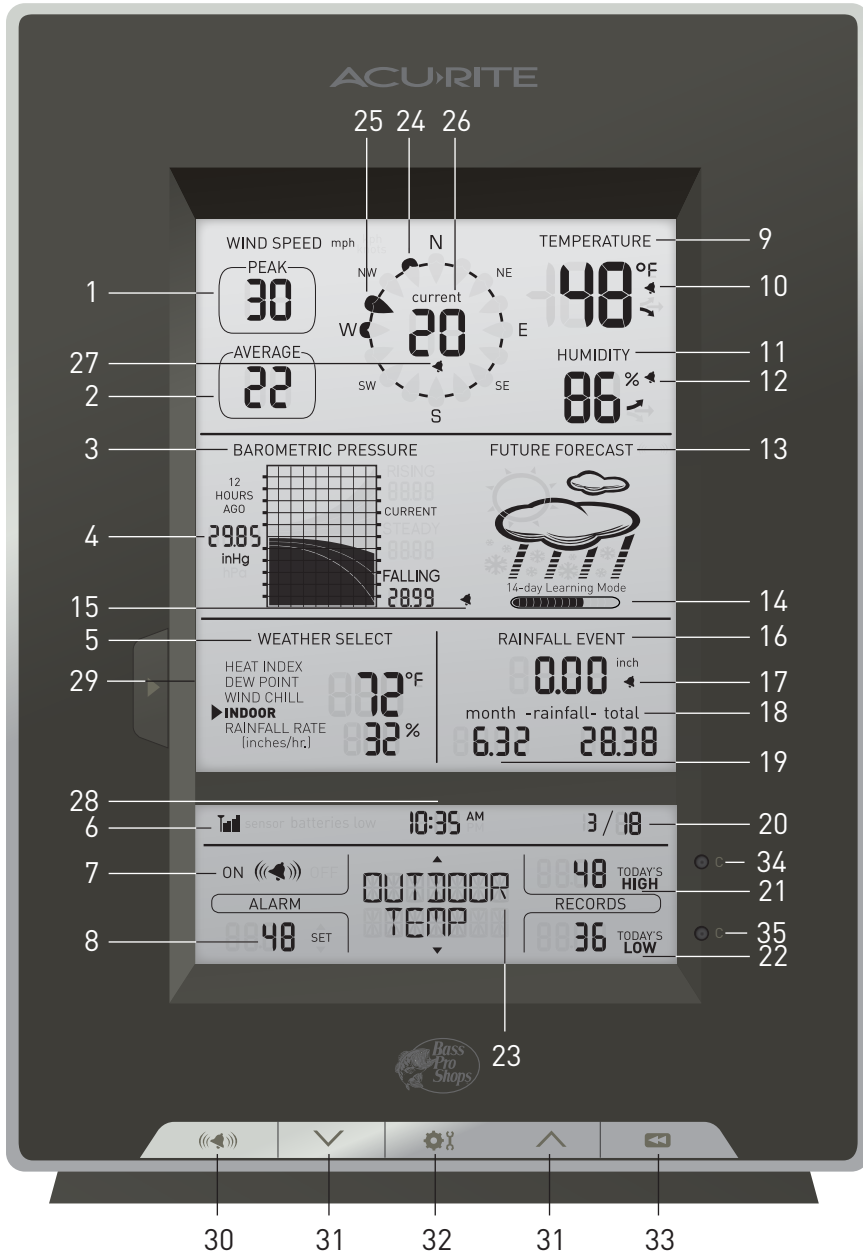

DISPLAY UNIT

- 1. Peak Wind Speed**
Highest speed from past 60 minutes.
- 2. Average Wind Speed**
of all speeds from past 2 minutes.
- 3. Pressure History Graph**
Current pressure on right with trend (Rising, Steady or Falling).
- 4. Historical Barometric Pressure**
Pressure reading 12 hours ago.
- 5. Weather Select**
Heat index, dew point, wind chill, indoor temperature / humidity, and rainfall rate (inches of rain per hour)
- 6. Wireless Sensor Signal Strength**
- 7. Alarm On/Off Indicator**
for Selectable Category (23)
- 8. Programmable Alarm Settings**
- 9. Current Outdoor Temperature**
Arrow icon indicates direction the temperature is trending.
- 10. Outdoor Temperature Alarm On Indicator**
- 11. Current Outdoor Humidity**
Arrow icon indicates the direction the humidity is trending.
- 12. Outdoor Humidity Alarm On Indicator**
- 13. 12 to 24 Hour Weather Forecast**
Self-Calibrating Forecasting pulls data from your 5-in-1 sensor to generate your personal forecast.
- 14. Learning Mode Icon**
Disappears after weather forecast self-calibration is complete.
- 15. Storm Alert Alarm On Indicator**
- 16. Current Rainfall**
Accumulates data during rainfall.
- 17. Rainfall Alarm On Indicator**
- 18. All-Time Rainfall**
- 19. Current Month Total Rainfall**
- 20. Date**
- 21. Record Highs**
Shown for current category selected on the display (23).
- 22. Record Lows**
Shown for current category selected on the display (23).
- 23. Selectable Category**
- 24. Previous 2 Wind Directions**
- 25. Current Wind Direction**
- 26. Current Wind Speed**
- 27. Wind Speed Alarm On Indicator**
- 28. Clock**
- 29. Weather Select Button**
Press to change the Weather Select category data being display.
- 30. Alarm On/Off Button**
Activate alarm; press and hold to adjust alarm values.
- 31. Select Category (shown in 23) & Change Settings**
- 32. Settings Button**
- 33. All-Time Records Button**
Press for all-time low and date recorded for current category selected on display (23). Press twice for all-time high and date recorded.
- 34. Clear Button**
Deletes record high (21) shown.
- 35. Clear Button**
Deletes record low (22) shown.

BACK OF DISPLAY UNIT (in battery compartment)

- 36. A-B-C Switch (not shown)**
ID code that must match 5-in-1 sensor's A-B-C switch to ensure units synchronize.
- 37. Clear Today (not shown)**
Clears data recorded since 12:00am.
- 38. Clear All (not shown)**
Clears all data recorded.
- 39. Reset (not shown)**
Full reset to factory defaults.

5-in-1 Sensor Setup

1 Install or Replace Batteries

Batteries **MUST** be installed for this product to operate. AcuRite recommends high quality alkaline or lithium batteries for the best product performance. Heavy duty or rechargeable batteries are not recommended.

The 5-in-1 sensor requires lithium batteries in low temperature conditions. Cold temperatures can cause alkaline batteries to function improperly. Use lithium batteries in the 5-in-1 sensor for temperatures below -4°F / -20°C.

1. Slide off the battery compartment cover.
2. Insert 4 x AA batteries into the battery compartment, as shown.

Follow the polarity (+/-) diagram in the battery compartment.

3. Replace the battery cover.

2 Remove Rain Gauge Stabilizer

Locate and remove the rain gauge stabilizer (plastic tab) taped into the bottom of the sensor. The rain gauge will not function until this is removed.

3 Set the A-B-C Switch

Locate the A-B-C switch inside the battery compartment. Set the A-B-C switch to A, B or C. You must select the same letter choices for both the sensor and the display unit in order for the units to synchronize.

LITHIUM BATTERIES -40°F (-40°C) (70°C) 158°F

ALKALINE BATTERIES -4°F (-20°C) (70°C) 158°F

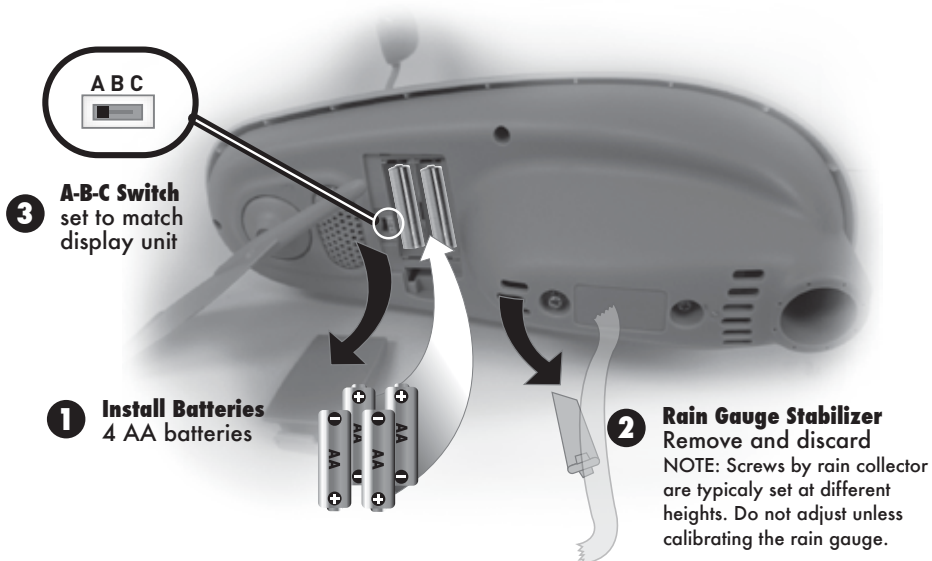

Display Unit Setup

1 Install or Replace Batteries

1. Slide off the battery compartment cover.
2. Insert 3 x AA alkaline batteries into the battery compartment, as shown. Follow the polarity (+/-) diagram in the battery compartment.
3. Replace the battery cover.

2 Set the A-B-C Switch

Locate the A-B-C switch inside the battery compartment. Set the A-B-C switch to A, B or C. You must select the same letter choices for both the display unit and the sensor in order for the units to synchronize.

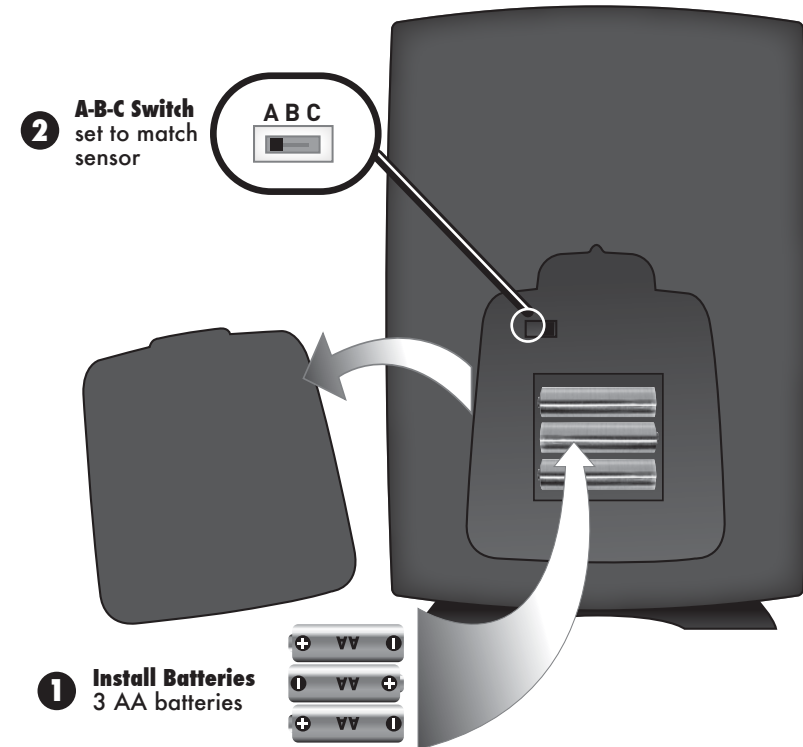

PLEASE DISPOSE OF OLD OR DEFECTIVE BATTERIES IN AN ENVIRONMENTALLY SAFE WAY AND IN ACCORDANCE WITH YOUR LOCAL LAWS AND REGULATIONS.

BATTERY SAFETY: Clean the battery contacts and also those of the device prior to battery installation. Remove batteries from equipment which is not to be used for an extended period of time. Follow the polarity (+/-) diagram in the battery compartment. Promptly remove dead batteries from the device. Dispose of used batteries properly. Only batteries of the same or equivalent type as recommended are to be used. DO NOT incinerate used batteries. DO NOT dispose of batteries in fire, as batteries may explode or leak. DO NOT mix old and new batteries or types of batteries (alkaline/standard). DO NOT use rechargeable batteries. DO NOT recharge non-rechargeable batteries. DO NOT short-circuit the supply terminals.

Set the Time & Date

The clock and calendar are utilized to time stamp history records and other data, so it is important to set the time and date soon after you power on the display unit.



Note: The "?" stays in Selectable Categories, even after setup.



Set the Time

1. Press the up or down arrow buttons until "SET CLOCK?" is displayed on the Selectable Category part of the display unit.
2. Press the "⚙️" button to set the clock.
3. Press the up or down arrows to adjust the hour. Note the "AM" and "PM" indicators.
4. Press the "⚙️" button to confirm hour selection.
5. Press the up or down arrows to adjust minutes.
6. Press the "⚙️" button to confirm minute selection.

The clock is now set.

Set the Date

1. Press the up or down arrow buttons until "SET DATE?" is displayed on the Selectable Category part of the display unit.
2. Press the "⚙️" button to set the date.
3. Press the up or down arrows to adjust the month.
4. Press the "⚙️" button to confirm month selection.
5. Press the up or down arrows to adjust the day.
6. Press the "⚙️" button to confirm day selection.
7. Press the up or down arrows to adjust the year.
8. Press the "⚙️" button to confirm year selection.

The date is now set.

Select Measurement Units

To select between standard units (mph, °F, etc.) or metric units (kph, °C, etc.):

1. Press the up or down arrow buttons until "SET UNITS?" is displayed on the Selectable Category part of the display unit.
2. Press the "⚙️" button to set the unit preference.
3. Press the up or down arrows to select "STAND" for standard or "METRIC" for metric units.
4. Press the "⚙️" button to confirm your selection.
5. Next, you will see "WIND MPH". Press the up or down arrows to select MPH, KPH, or KNOTS for wind speed units.
6. Press the "⚙️" button to confirm your selection.

Units are now set.

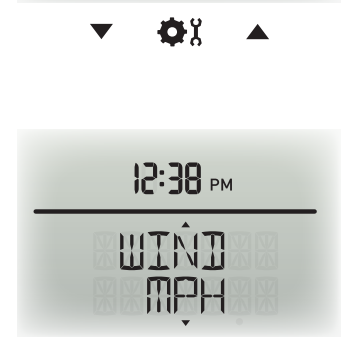

Placement for Maximum Accuracy

AcuRite sensors are sensitive to surrounding environmental conditions. Proper placement of both the display unit and the sensor are critical to the accuracy and performance of this product.



Display Unit Placement

Place the display unit in a dry area free of dirt and dust. To ensure accurate temperature measurement, place out of direct sunlight and away from heat sources or vents. Display unit stands upright for tabletop use or is wall-mountable.



5-in-1 Sensor Placement

The 5-in-1 sensor is designed to remain outdoors all year long. Choose an open location with no obstructions above or around the sensor for the most accurate measurements.

Important Placement Guidelines

Display unit and sensor must be within 330ft (100m) of each other.

MAXIMIZE WIRELESS RANGE

Place units away from large metallic items, thick walls, metal surfaces, or other objects that may limit wireless communication.

PREVENT WIRELESS INTERFERENCE

Place both units at least 3ft (.9m) away from electronic devices (TV, computer, microwave, radio, etc.).

LOCATE AWAY FROM HEAT SOURCES

Position sensor away from heaters, air conditioners, chimneys, exhaust vents, asphalt and concrete (surfaces that radiate heat).

LOCATE AWAY FROM HUMIDITY SOURCES

Avoid installing the sensor near pools, spas, or other bodies of water. Water sources may impact humidity accuracy.

LOCATE AWAY FROM SPRINKLER HEADS

DO NOT install the sensor where it will be sprayed by a sprinkler system. This impacts rainfall measurement accuracy and may force water inside the sensor.

LOCATE AWAY FROM WIND & RAIN OBSTRUCTIONS

DO NOT mount the sensor with obstructions above it, as this will impact rainfall measurement. Consider a location that is a wide open area, with few structures around to ensure accurate wind speed and direction measurements.

Visit us online to view installation photos and video, or learn more about AcuRite technology:

www.AcuRite.com/5in1



View Video

5-in-1 Installation Guidelines

INSTALLATION HEIGHT Mount the sensor at least 5 feet (1.5 meters) off the ground (higher is better for wind measurement) in an open area. Secure to fence post, 2'x4' wood, 3/4" pipe, etc. (not included)

LEVEL INSTALLATION Use the bubble level on the top of the sensor to ensure level installation for accurate wind and rain measurement.

SOLAR CELL ORIENTATION Install the sensor with the **solar cell facing SOUTH**. This ensures the cell receives as much sun as possible, and orients wind direction.

5-in-1 Sensor Installation

1. Fasten mounting base (included) to a post or pole (not included) using the 4 longer screws included in the hardware bag.
2. Insert the mounting base into the hole on the bottom of the sensor.
3. Make sure the arrows on the top of the sensor are pointed in the proper direction and the bubble level is centered. The solar cell should be facing south to properly orient the wind direction vane.
3. Fasten the sensor into the mounting base using the 2 shorter screws included in the hardware bag.

The 5-in-1 sensor is now ready to use.

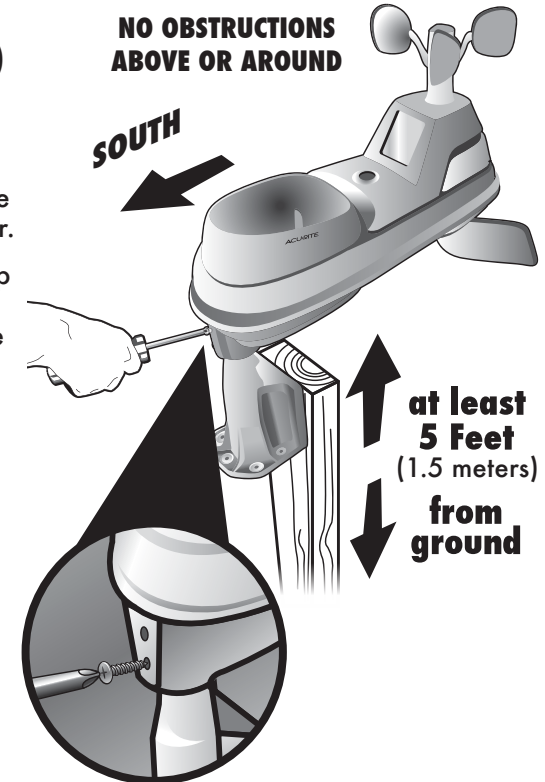

Clear Data Collected During Installation

When installation is complete, clear erroneous data from the display unit by pressing the "CLEAR TODAY" button, on the back of the display unit inside the battery compartment. This button will clear data recorded since 12:00am.

Basic Setup is Complete

The 5-in-1 sensor will now synchronize with the display unit. It may take a few minutes for synchronization to complete. If both or one of the units appear to be functioning improperly, please refer to the troubleshooting section.

Using the Professional Weather Center

Weather Forecast

AcuRite's patented Self-Calibrating Forecasting provides your personal forecast of weather conditions for the next 12 to 24 hours by collecting data from the sensor in your backyard. It generates a forecast with pinpoint accuracy - personalized for your exact location.

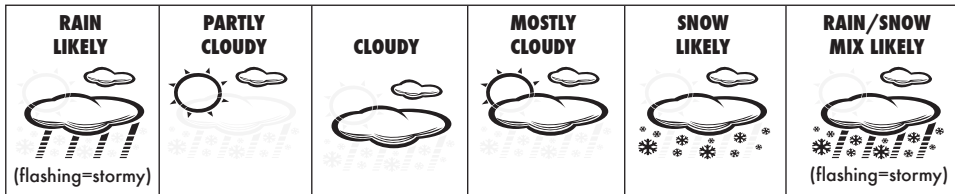

View the complete list of icons at www.AcuRite.com/acurite-icons

"Learning Mode"

Self-Calibrating Forecasting use a unique algorithm to analyze changes in pressure and temperature over a time period (called Learning Mode) to determine your altitude. After 14 days, the Learning Mode icon disappears from the display screen. At this point, the self-calibrated pressure is tuned in to your location and the unit is ready for superior weather prediction.

Barometric Pressure

Subtle variations in barometric pressure greatly affect the weather. This weather forecaster displays the current pressure, direction it's trending (FALLING, STEADY, or RISING) and a pressure chart. The chart tracks and displays the change in pressure so you can monitor the rate of change over time.

Rainfall Event

The rainfall feature tracks rain accumulation over all-time, the current month, and current rainfall event. Current event clears when no rain registers for 8 hours OR no rain registers for 1 hour and pressure rises by .03inHg or more.

Programmable Weather Alarms

Each Selectable Weather Category features an alarm option. When an alarm sounds, the display unit emits an audible beeping and flashes the affected category, its alarm settings, and any other relevant data.

Some alarms can be customized to alert you when your programmed value is reached. Alarms include: outdoor temperature, outdoor humidity, wind speed, heat index, dew point, wind chill, indoor temperature and indoor humidity.

The rain alarm does not require a preset numerical value, but instead sounds as soon as rain is recorded. Similarly, the storm alarm sounds when a large atmospheric pressure drop occurs, which usually indicates an oncoming storm.

Note: The storm alarm is NOT intended to be a safety device or warning system.

Set a Weather Alarm

1. Choose the weather category for which you wish to set an alarm by pressing the up or down arrow buttons until the category is displayed on the Selectable Category part of the display unit.
2. To program a value (only applies to alarms that require a value), press AND HOLD the "🔊" button until the "SET" indicator appears in the area of the display labeled "ALARM" (left of the selected weather category) and the alarm setting flashes.
3. Adjust the alarm value by pressing the up or down arrow buttons.
4. Press the "⚙️" button to confirm a value.
5. Next, press the "🔊" button to activate the alarm. The alarm ON indicator will highlight on the display.

Alarm is now programmed and turned on.

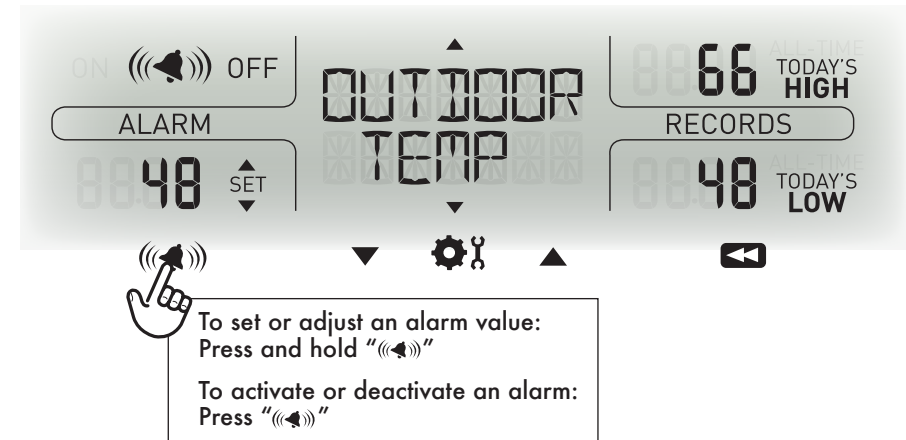

Silence a Sounding Alarm

The alarm sounds initially for a few minutes, then silences itself. The alarm then sounds every few minutes afterwards until one of the following happens:

1. "SNOOZE" - Press any button. Alarm silences, but sounds again if the alarm condition reoccurs.
2. Turn the alarm "OFF" - Deactivates the alarm.

Troubleshooting

Problem	Possible Solution
<p>No outdoor sensor reception</p> 	<ul style="list-style-type: none"> Relocate the display unit and/or the 5-in-1 sensor. The units must be within 330ft (100m) of each other. Make sure both units are placed at least 3 feet (.9m) away from electronics that may interfere with the wireless communication (such as TVs, microwaves, computers, etc). Use standard alkaline batteries (or lithium batteries in sensor when temperature is below -4°F/-20°C). Do not use heavy duty or rechargeable batteries. NOTE: It may take up to 20 minutes for display unit and sensor to synchronize after batteries are replaced. Synchronize the units: <ol style="list-style-type: none"> Bring both the sensor and display unit indoors and remove at least one battery from each. Reinstall the battery in the outdoor sensor. Reinstall battery into the display unit. Let the units sit within a couple feet of each other for about 20 minutes to gain a strong connection.
<p>Outdoor temperature is flashing or showing dashes</p>	<p>Flashing of the outdoor temperature may be an indication of wireless interference.</p> <ul style="list-style-type: none"> Make sure the A-B-C switch in the battery compartments of both the display unit and sensor are switched to the same letter. You may choose A, B or C; but both units must match for successful synchronization.
<p>Display screen not working</p>	<ul style="list-style-type: none"> Check that the batteries are installed correctly. Batteries may need to be replaced. Reset the display by pressing the reset button, located on the back of the display unit. Date and time will need to be entered after a reset.
<p>Inaccurate forecast (Continued on p.15)</p>	<ul style="list-style-type: none"> The Weather Forecast icon is a prediction of conditions for the next 12 to 24 hours. It is not showing current conditions.

Troubleshooting

Problem	Possible Solution
<p>Inaccurate forecast (Continued from p.14)</p>	<ul style="list-style-type: none"> Has Learning Mode icon disappeared from the display unit? Learning Mode must be completed before the forecast and pressure will be accurate. Allow the unit to run continuously for 33 days. Battery removal or resetting the display unit restarts Learning Mode. After 14 days, forecast should be fairly accurate, however Learning Mode continues to calibrate for a total of 33 days.
<p>Inaccurate temperature or humidity</p>	<ul style="list-style-type: none"> Make sure both the display unit and 5-in-1 sensor are placed out of direct sunlight and away from any heat sources or vents (see page 10). Make sure both units are positioned away from moisture sources (see page 10). Make sure 5-in-1 sensor is mounted at least 5ft off of the ground. Calibrate indoor and outdoor temperature and humidity (see page 17).
<p>No rainfall</p>	<ul style="list-style-type: none"> Check to ensure the rain gauge stabilizer (plastic tab) has been removed from the bottom of the sensor (see page 6). Clear debris, such as leaves, out of the rain collector funnel and debris screen. See Calibrate the Rain Gauge on page 17.
<p>Inaccurate wind readings</p>	<ul style="list-style-type: none"> What is wind reading being compared to? Pro weather stations are typically mounted at 30ft high or more. Make sure to compare data using a sensor positioned at the same mounting height. Check location of the sensor. Ensure it's mounted a minimum of 5ft in the air with no obstructions around it (within several feet). Ensure wind cups are spinning freely. If they hesitate or stop try lubricating with graphite powder or WD-40.

If your AcuRite product does not operate properly after trying the troubleshooting steps, visit www.AcuRite.com or call (877) 221-1252 for assistance.

Care & Maintenance

Display Unit Care

Clean with a soft, damp cloth. Do not use caustic cleaners or abrasives. Keep away from dust, dirt and moisture. Clean ventilation ports regularly with a gentle puff of air.

5-in-1 Sensor Care

Clean The Sensor

Clean with a soft damp cloth. Do not use caustic cleaners or abrasives that will mar the polished surfaces of the rain collection funnel or the solar cell. Scratches will result in decreased performance and reliability.

Insect Prevention

Insects may cause obstructions and interrupt data by nesting in or on the 5-in-1 sensor. To limit this problem, spray sensor with a household insect repellent. Consult the insect repellent instructions prior to use.

Snow & Freezing Weather

The 5-in-1 sensor will not be damaged by freezing conditions. NOTE: If the rain collector cup fills with snow and then melts, it will register as rain on the display unit.

Clean The Rain Collector Cup

Remove and empty rain collector debris filter. The debris filter is located in the rain collector funnel. Remove from the top by gently squeezing and pulling out.

Clean the Wind Vane & Anemometer

Remove foreign matter from the outside of the sensor for free movement of the wind vane and anemometer. If needed, use a small amount of spray lubricant, clear silicone or graphite powder on the anemometer for improved movement.

Calibration

Calibrate Temperature & Humidity

The indoor / outdoor temperature and humidity readings can be calibrated on the display unit to improve accuracy. Calibration improves accuracy when 5-in-1 sensor placement or environmental factors impact your data accuracy.

1. Choose the weather category you wish to calibrate by pressing the up or down arrow buttons until the category is displayed on the Selectable Category part of the display unit.

2. Press AND HOLD the up and down arrow buttons and the "⚙️" button all at the same time for 15-20 seconds.
 - The display unit beeps, and all display data is hidden except for the value being calibrated.
 - "CAL" (calibrate) and arrows appear next to the value being calibrated.
3. Press the up or down arrow buttons to calibrate the data value higher or lower from the actual reading.
4. Press the "⚙️" button to confirm the calibration adjustment. Note: The "CAL" icon remains illuminated next to calibrated values.

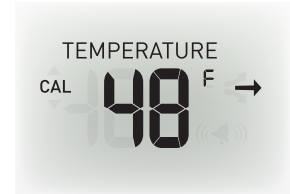

Calibrate the Rain Gauge

The rain gauge on the 5-in-1 sensor can be calibrated to improve accuracy.

Items Needed: 5-in-1 sensor, display unit, plastic cup, pin, screw driver

1. First, ensure 5-in-1 sensor is perfectly level using built-in bubble level.
2. Place display unit close so you can monitor it during calibration.
3. Make a pin hole in the bottom of a plastic cup. Hold the cup over the rain gauge and fill it with exactly 1 cup (8oz.) of water, allowing the water to drip into the rain gauge. You should hear the internal buckets tip and see water drain through the rain gauge.
4. A few seconds after each bucket tip, the display unit displays rainfall in approximately 0.01" or more increments.
5. The cup of water should take more than 10 minutes to empty; a quicker period will result in inaccurate calibration. Try to simulate a normal steady rainfall. When cup is empty of water, display unit should register 1.06"

Tips

- There should be nearly an equal number of water drops (about 25 water drops) between bucket tips. If not, adjust the calibration screws on the bottom of the 5-in-1 sensor until an equal number of water drops are tipping the buckets. Then, restart the calibration procedure.
- If you don't hear the buckets tipping and see water dripping alternately out of each drain, there may be an issue with the rain gauge or its adjustment. See Troubleshooting on page 15.

Adjustment

If the rain gauge doesn't register close to 1.06", make an EQUAL adjustment to the two calibration screws on the bottom of the 5-in-1 sensor. Turning screws clockwise increases rainfall; counter clockwise decreases rainfall.

- To adjust the rainfall reading by 2% turn both screws 1/8 of a turn.
- To adjust the rainfall reading by 4% turn both screws 1/4 of a turn.
- To adjust the rainfall reading by 8% turn both screws 1/2 of a turn.

Specifications

TEMPERATURE RANGE	Outdoor: -40°F to 158°F; -40°C to 70°C
	Indoor: 32°F to 122°F; 0°C to 50°C
HUMIDITY RANGE	Outdoor: 1% to 99%
	Indoor: 16% to 98%
WIND SPEED	0 to 99 mph; 0 to 159 kph
WIND DIRECTION INDICATORS	16 points
RAINFALL	0 to 99.99 in
WIRELESS RANGE	330ft / 100m depending on home construction materials
OPERATING FREQUENCY	433mhz
POWER	7 x AA alkaline or lithium batteries (not included)
DATA REPORTING	Wind Speed: 18 seconds; Direction: 30 seconds
	Outdoor temperature & humidity: 36 sec. updates
	Indoor temperature & humidity: 60 sec. updates

FCC Information

This device complies with part 15 of FCC rules. Operation is subject to the following two conditions:

- 1- This device may NOT cause harmful interference, and
 - 2- This device must accept any interference received, including interference that may cause undesired operation.
- This equipment has been tested and found to comply with the limits for a Class B digital device, pursuant to Part 15 of the FCC rules. These limits are designed to provide reasonable protection against harmful interference in a residential installation. This equipment generates, uses and can radiate radio frequency energy and, if not installed and used in accordance with the instructions, may cause harmful interference to radio communications. However, There is no guarantee that interference will not occur in a particular installation. If this equipment does cause harmful interference to radio or television reception, which can be determined by turning the equipment off and on, the user is encouraged to try to correct the interference by one or more of the following measures:
- Reorient or relocate the receiving antenna.
 - Increase the separation between the equipment and the receiver.
 - Connect the equipment into an outlet on a circuit different from that to which the receiver is connected.
 - Consult the dealer or an experienced radio/TV technician for help.

NOTE: The manufacturer is not responsible for any radio or TV interference caused by unauthorized modifications to this equipment. Such modifications could void the user authority to operate the equipment.

Customer Support

AcuRite customer support is committed to providing you with best-in-class service. **For assistance**, please have the model number of this product available and contact us in any of the following ways:



(877) 221-1252



info@chaney-inst.com

24/7 support at www.AcuRite.com

- › Installation Videos
- › Register your Product
- › Instruction Manuals
- › Support User Forum
- › Replacement Parts
- › Submit Feedback & Ideas

IMPORTANT

PRODUCT MUST BE REGISTERED TO RECEIVE WARRANTY SERVICE

PRODUCT REGISTRATION

Register online to receive 1-year warranty protection

www.AcuRite.com

SUPPORT

Support Forum

Archived Products

▶ Register a Product

Limited One Year Warranty

At AcuRite, we proudly uphold our commitment to quality technology. Chaney Instrument Co. warrants that all products it manufactures to be of good material and workmanship, and to be free of defects when properly installed and operated for a period of one year from the date of purchase.

We recommend that you visit us at www.AcuRite.com for the fastest way to register your product. However, product registration does not eliminate the need to retain your original proof of purchase in order to obtain warranty benefits.

Chaney Instrument Co. warrants that all products it manufactures to be of good material and workmanship, and to be free of defects when properly installed and operated for a period of one year from the date of purchase. Remedy for breach of this warranty is limited to repair or replacement of the defective item(s). Any product which, under normal use and service, is proven to breach the warranty contained herein within ONE YEAR from date of sale will, upon examination by Chaney, and at its sole option, be repaired or replaced by Chaney. Transportation costs and charges for returned goods shall be paid for by the purchaser. Chaney hereby disclaims all responsibility for such transportation costs and charges. This warranty will not be breached, and Chaney will give no credit for products it manufactures which have received

normal wear and tear, been damaged (including by acts of nature), tampered, abused, improperly installed, damaged in shipping, or repaired or altered by others than authorized representatives of Chaney.

The above-described warranty is expressly in lieu of all other warranties, express or implied, and all other warranties are hereby expressly disclaimed, including without limitation the implied warranty of merchantability and the implied warranty of fitness for a particular purpose. Chaney expressly disclaims all liability for special, consequential or incidental damages, whether arising in tort or by contract from any breach of this warranty. Some states do not allow the exclusion or limitation of incidental or consequential damages, so the above limitation or exclusion may not apply to you. Chaney further disclaims all liability from personal injury relating to its products to the extent permitted by law. By acceptance of any of Chaney's products, the purchaser assumes all liability for the consequences arising from their use or misuse. No person, firm or corporation is authorized to assume for Chaney any other liability in connection with the sale of its products. Furthermore, no person, firm or corporation is authorized to modify or waive the terms of this paragraph, and the preceding paragraph, unless done in writing and signed by a duly authorized agent of Chaney. This warranty gives you specific legal rights, and you may also have other rights which vary from state to state.

For in-warranty claims:
Chaney Instrument Co. | 965 Wells St. | Lake Geneva, WI 53147

Free Manuals Download Website

<http://myh66.com>

<http://usermanuals.us>

<http://www.somanuals.com>

<http://www.4manuals.cc>

<http://www.manual-lib.com>

<http://www.404manual.com>

<http://www.luxmanual.com>

<http://aubethermostatmanual.com>

Golf course search by state

<http://golfingnear.com>

Email search by domain

<http://emailbydomain.com>

Auto manuals search

<http://auto.somanuals.com>

TV manuals search

<http://tv.somanuals.com>