



# NF7 Series

**(NF7/NF7-M/NF7-S/NF7-S2/NF7-S2G)**

---

*Socket 462 System Board*

*User's Manual*

4200-0316-10  
Rev. 1.01

---

---

## **Copyright and Warranty Notice**

The information in this document is subject to change without notice and does not represent a commitment on part of the vendor, who assumes no liability or responsibility for any errors that may appear in this manual.

No warranty or representation, either expressed or implied, is made with respect to the quality, accuracy or fitness for any particular part of this document. In no event shall the manufacturer be liable for direct, indirect, special, incidental or consequential damages arising from any defect or error in this manual or product.

Product names appearing in this manual are for identification purpose only and trademarks and product names or brand names appearing in this document are the property of their respective owners.

This document contains materials protected under International Copyright Laws. All rights reserved. No part of this manual may be reproduced, transmitted or transcribed without the expressed written permission of the manufacturer and authors of this manual.

If you do not properly set the motherboard settings, causing the motherboard to malfunction or fail, we cannot guarantee any responsibility.

---

---

# Table of Contents

---

<b>Chapter 1. Introduction .....</b>	<b>1-1</b>
1-1. Features & Specifications .....	1-1
1-2. Layout Diagram (NF7/NF7-S).....	1-4
1-3. Layout Diagram (NF7-M).....	1-5
1-4. Layout Diagram (NF7-S2/NF7-S2G, Ver. 0.22) .....	1-6
<b>Chapter 2. Hardware Setup.....</b>	<b>2-1</b>
2-1. Install The Motherboard.....	2-1
2-2. Install CPU and Heatsink .....	2-1
2-3. Install System Memory .....	2-3
2-4. Connectors, Headers and Switches .....	2-4
(1). ATX Power Input Connectors.....	2-4
(2). FAN Connectors.....	2-5
(3). CMOS Memory Clearing Header .....	2-6
(4). Wake-up Header.....	2-7
(5). Front Panel Switches & Indicators Headers .....	2-9
(6). Infrared Device Header (NF7/NF7-S/NF7-M) .....	2-10
(7). Additional USB Port Headers .....	2-11
(8). Additional IEEE1394 Port Headers (NF7-S).....	2-12
(9). Front Panel Audio Connection Header .....	2-13
(10). Internal Audio Connectors .....	2-15
(11). Accelerated Graphics Port Slot.....	2-16
(12). Floppy Disk Drive Connector .....	2-17
(13). IDE Connectors.....	2-18
(14). Serial ATA Connectors (NF7-S/NF7-S2/NF7-S2G) .....	2-20
(15). Status Indicators .....	2-21
(16). System Management Bus Headers.....	2-22
(17). Back Panel Connectors .....	2-23
<b>Chapter 3. BIOS Setup.....</b>	<b>3-1</b>
3-1. SoftMenu Setup.....	3-2
3-2. Standard CMOS Features.....	3-6
3-3. Advanced BIOS Features.....	3-10
3-4. Advanced Chipset Features.....	3-13
3-5. Integrated Peripherals .....	3-16

---

---

3-6.	Power Management Setup .....	3-25
3-7.	PnP/PCI Configurations.....	3-28
3-8.	PC Health Status .....	3-32
3-9.	Load Fail-Safe Defaults .....	3-33
3-10.	Load Optimized Defaults .....	3-33
3-11.	Set Password .....	3-33
3-12.	Save & Exit Setup .....	3-33
3-13.	Exit Without Saving.....	3-33
<b><i>Appendix A. Install NVIDIA nForce Chipset Driver .....</i></b>		
<b><i>Appendix B. Install Integrated GPU Driver (NF7-M).....</i></b>		
<b><i>Appendix C. Install USB 2.0 Driver .....</i></b>		
<b><i>Appendix D. Install LAN Driver (NF7-S2G) .....</i></b>		
<b><i>Appendix E. Install Serial ATA Driver (NF7-S).....</i></b>		
<b><i>Appendix F. BIOS Setup for NVRAID (NF7-S2/NF7-S2G).....</i></b>		
<b><i>Appendix G. ABIT EQ (The Hardware Doctor Utility).....</i></b>		
<b><i>Appendix H. FlashMenu (BIOS Update Utility).....</i></b>		
<b><i>Appendix I. Troubleshooting (Need Assistance?).....</i></b>		
<b><i>Appendix J. How to Get Technical Support.....</i></b>		

---

# Chapter 1. Introduction

---

## 1-1. Features & Specifications

---

### 1. CPU

- Supports AMD-K7 Duron/Athlon/Athlon XP/Barton Socket A 200/266/333/400 MHz FSB

### 2. Chipset

- NVIDIA nForce2 Ultra 400 chipset with MCP (*NF7*)
- NVIDIA nForce2 IGP chipset with MCP (*NF7-M*)
- NVIDIA nForce2 Ultra 400 chipset with MCP-T (*NF7-S*)
- NVIDIA nForce2 Ultra 400 chipset with RAID MCP (*NF7-S2/NF7-S2G*)
- Integrated 128-bit memory controller
- Supports Advanced Configuration and Power Interface (ACPI)
- AGP (Accelerated Graphics Port) connector supports AGP 8X/4X (0.8V/1.5V)

### 3. Dual DDR

- Dual DDR architecture combines two independent 64-bit memory controllers
- Dual DDR 400 provides up to 6.4GB/s bandwidth for system memory

### 4. Memory

- Three 184-pin DIMM slots
- Supports 3 DIMMs DDR 200/266/333 (Max. 3GB)
- Supports 2 DIMM DDR 400 (Max. 2GB)
- Supports DDR 400 only when using an add-on VGA card (*NF7-M*)

### 5. Audio

- Onboard 6-Channel AC 97 CODEC
- Professional digital audio interface supports optical S/PDIF OUT (*NF7/NF7-S/NF7-M*)
- NVIDIA SoundStorm™ Technology with real-time Dolby Digital 5.1 encoder (*NF7-S*)

### 6. LAN

- Onboard 10/100M LAN Controller (*NF7/NF7-S/NF7-M/NF7-S2*)
- Onboard 10/100/1000M LAN Controller (*NF7-S2G*)

### 7. ABIT Engineered

- ABIT SoftMenu™ Technology
- ABIT FanEQ™ Technology
- ABIT CPU ThermalGuard™ Technology
- ABIT FlashMenu™

## 8. Internal I/O Connectors

- 1 x 8X/4X AGP slot
- 5 x PCI slots
- 1 x floppy port supports up to 2.88 MB
- 2 x Ultra DMA 33/66/100/133 connectors
- 2 x USB 2.0 headers
- 1 x CD-IN header
- 1 x IrDA (*NF7/NF7-S/NF7-M*)
- 2 x IEEE 1394a headers (*NF7-S*)
- 2 x Serial ATA 150 connectors (*NF7-S/NF7-S2/NF7-S2G*)

## 9. Back Panel I/O

- 1 x PS/2 keyboard, 1 x PS/2 mouse
- Audio connectors (Front Speaker, Line-in, Mic-in, Center/Sub, Surround Speaker)
- 1 x S/PDIF Out connector (*NF7/NF7-S/NF7-M*)
- 1 x Serial port connector, 1 x Parallel port connector (*NF7-S2/NF7-S2G*)
- 2 x Serial port connectors, 1 x Parallel port connector (*NF7/NF7-S*)
- 1 x Serial port connector, 1 x Parallel port connector, 1 x VGA Connector (*NF7-M*)
- 4 x USB, 1 x RJ-45 LAN connector (*NF7-S2/NF7-S2G*)
- 2 x USB, 1 x RJ-45 LAN connector (*NF7/NF7-S/NF7-M*)

## 10. SATA 150 RAID (*NF7-S/NF7-S2/NF7-S2G*)

- Onboard Silicon Image Sil 3112A SATA PCI Controller (*NF7-S*)
- Supports SATA 150 NV RAID (*NF7-S2/NF7-S2G*)
- Supports 2 channels of Serial ATA 150MB/s data transfer rate with RAID function (0/1)

## 11. IEEE 1394 (*NF7-S*)

- Supports IEEE 1394a at 400/200/100 Mb/s transfer rate

## 12. Graphics (*NF7-M*)

- NVIDIA GeForce4 MX class graphics processor

## 13. Miscellaneous

- ATX form factor
- Hardware Monitoring – Including Fan speed, Voltages, CPU and System temperature

#### 14. Order Information

Model	Chipset	Features
NF7-S	nForce2 Ultra 400 + MCP-T	SATA RAID, IEEE1394, 6-ch Audio with SoundStorm™, S/PDIF Out, 10/100M, SERILLEL2
NF7	nForce2 Ultra 400 + MCP	10/100M, 6-ch Audio, S/PDIF Out
NF7-M	nForce2 IGP + MCP	Integrated GeForce4 MX, 10/100M, 6-ch Audio, S/PDIF Out
NF7-S2	nForce2 Ultra 400 + RAID MCP	NV SATA RAID, 6-ch Audio, 10/100M
NF7-S2G	nForce2 Ultra 400 + RAID MCP	NV SATA RAID, 6-ch Audio, GbE

- \* **The Serial ATA controller only supports Ultra DMA/ATA100 or higher hard drive. Do not use hard drives under this specification, or it won't work.**
- \* **This motherboard supports the standard bus speeds of 66 MHz/100 MHz/133 MHz that are used by specific PCI, processor and chipset specifications. Exceeding these standard bus speeds is not guaranteed due to the specific component specifications.**
- \* **Specifications and information contained herein are subject to change without notice.**

## 1-2. Layout Diagram (NF7/NF7-S)

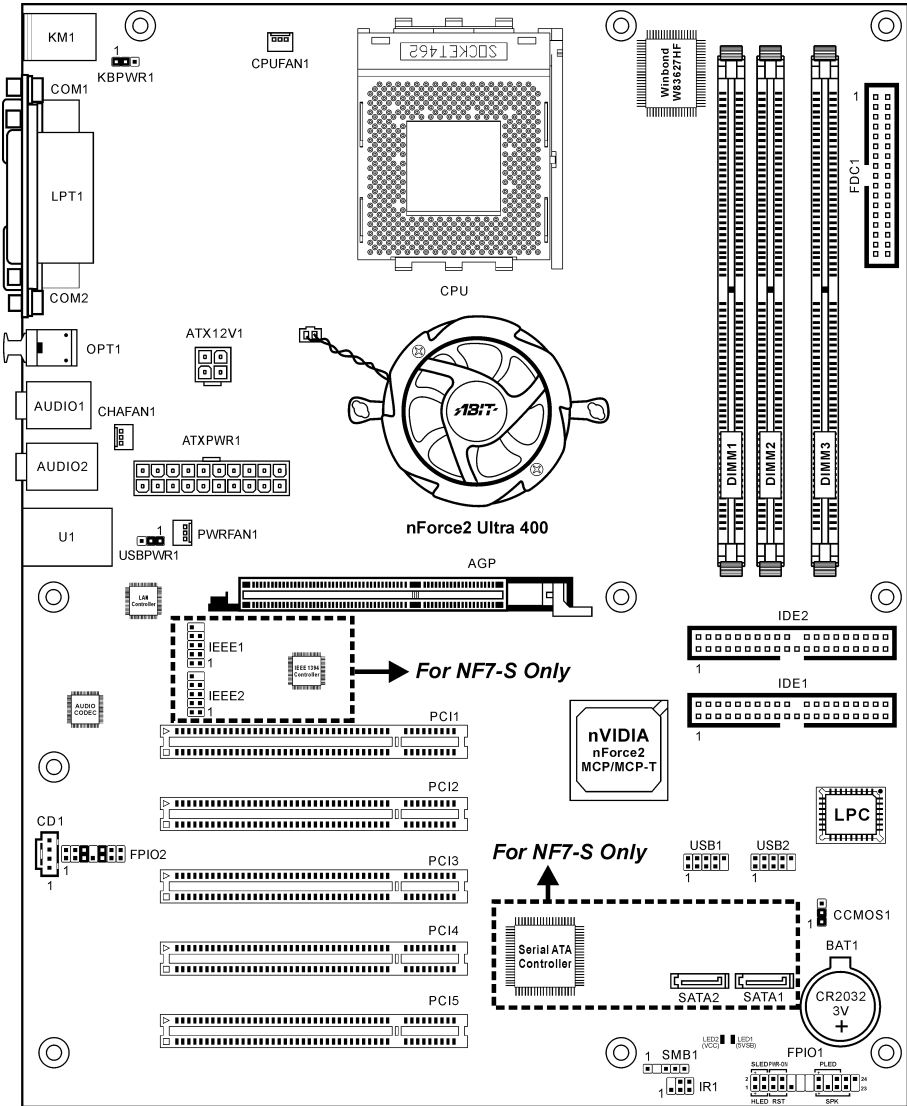



### 1-3. Layout Diagram (NF7-M)

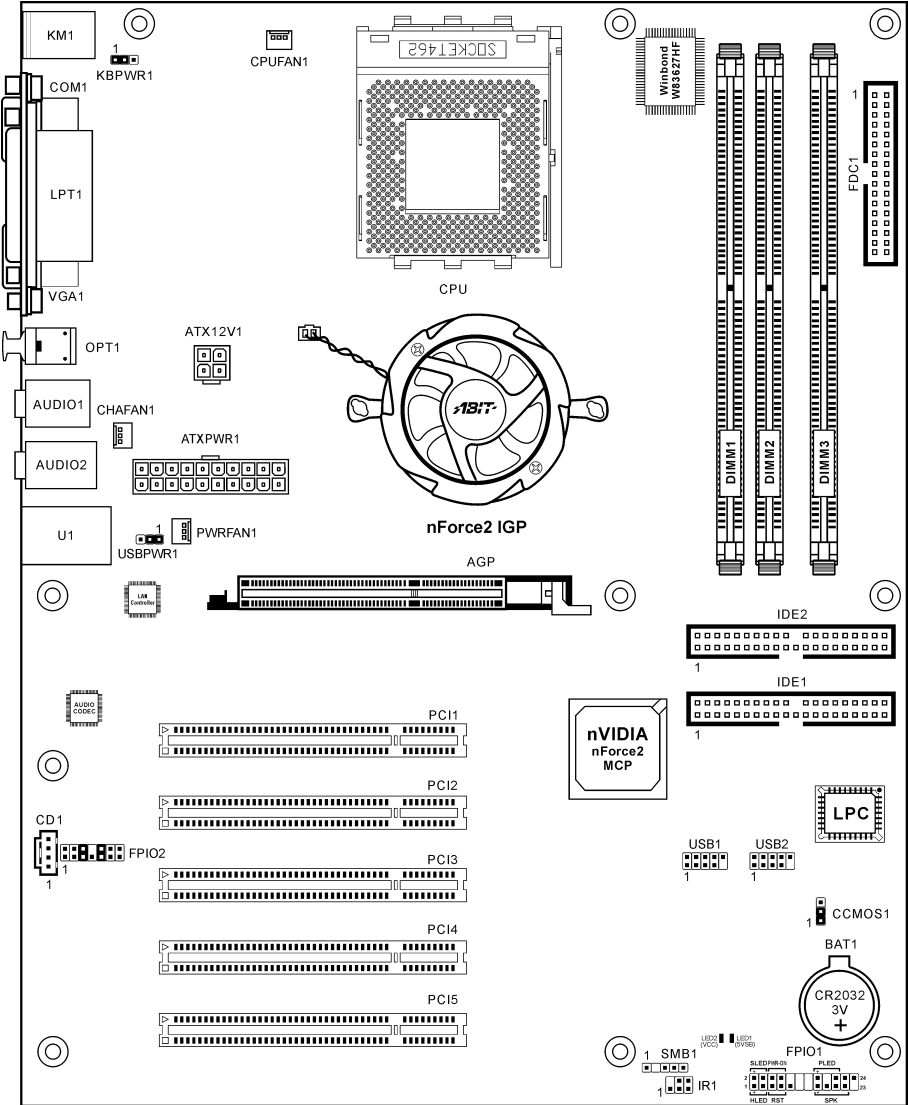

### 1-4. Layout Diagram (NF7-S2/NF7-S2G, Ver. 0.22)

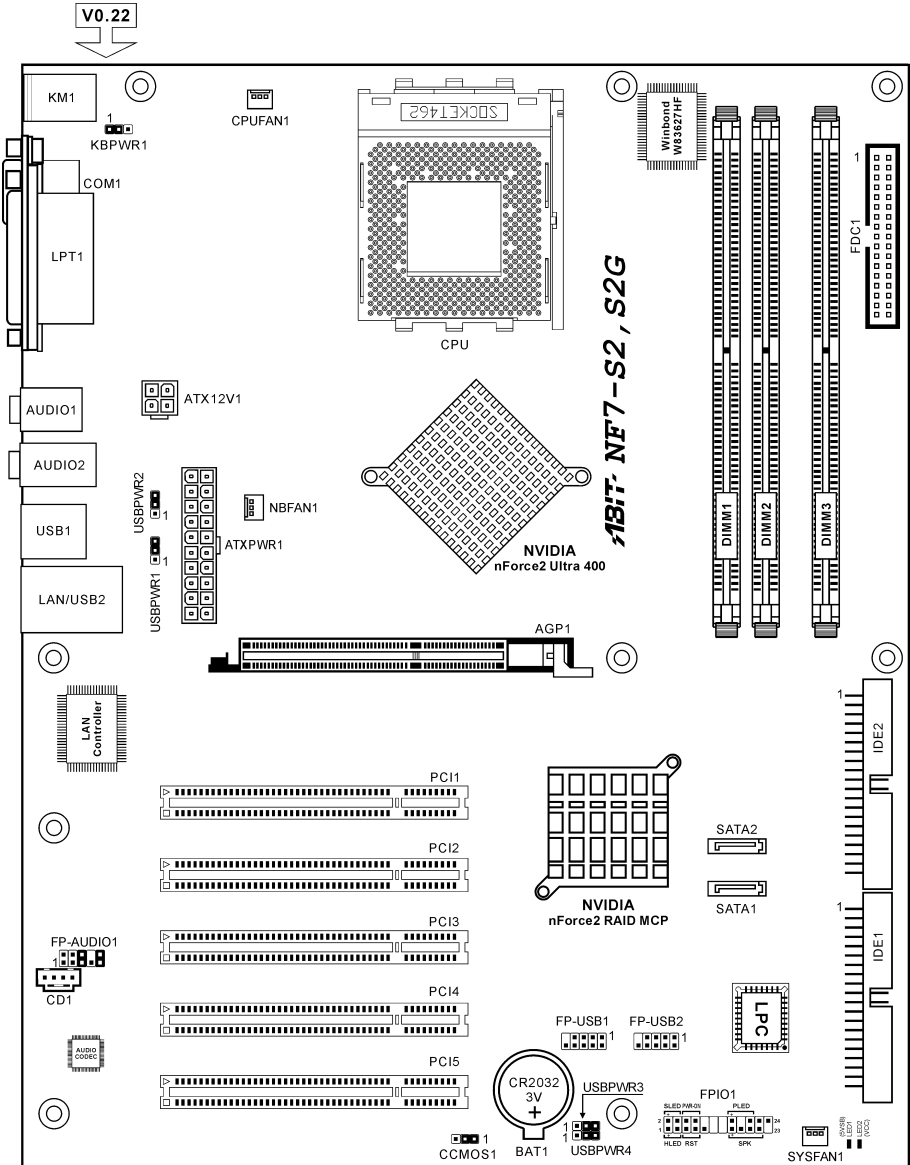

## Chapter 2. Hardware Setup

**Before the Installation:** Turn off the power supply switch (fully turn off the +5V standby power), or disconnect the power cord before installing or unplugging any connectors or add-on cards. Failing to do so may cause the motherboard components or add-on cards to malfunction or damaged.

### 2-1. Install The Motherboard

Most computer chassis have a base with many mounting holes to allow motherboard to be securely attached on and at the same time, prevented from short circuits. There are two ways to attach the motherboard to the chassis base:

1. use with studs
2. or use with spacers

In principle, the best way to attach the board is to use with studs. Only if you are unable to do this should you attach the board with spacers. Line up the holes on the board with the mounting holes on the chassis. If the holes line up and there are screw holes, you can attach the board with studs. If the holes line up and there are only slots, you can only attach with spacers. Take the tip of the spacers and insert them into the slots. After doing this to all the slots, you can slide the board into position aligned with slots. After the board has been positioned, check to make sure everything is OK before putting the chassis back on.

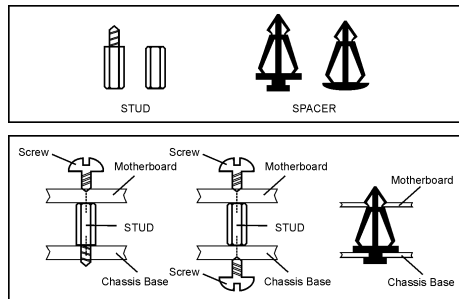

**ATTENTION:** To prevent shorting the PCB circuit, please REMOVE the metal studs or spacers if they are already fastened on the chassis base and are without mounting-holes on the motherboard to align with.

### 2-2. Install CPU and Heatsink

#### Note

- Installing a heatsink and cooling fan is necessary for heat to dissipate from your processor. Failing to install these items may result in overheating and processor damage.
- The AMD Socket A processor will produce a lot of heat while operating, so you need to use a large heat sink that is especially designed for the AMD socket A processor. Otherwise, it may result in overheating and processor damage.
- If your processor fan and its power cable are not installed properly, never plug the ATX power cable into the motherboard. This can prevent possible processor damage.
- Please refer to your processor installation manual or other documentation with your processor for detailed installation instructions.

This motherboard provides a ZIF (Zero Insertion Force) Socket 462 to install AMD Socket A CPU. The CPU you bought should have a kit of heatsink and cooling fan along with. If that's not the case, buy one specially designed for Socket A.

Please refer to the figure shown here to install CPU and heatsink. (For reference only. Your Heatsink & Fan Assembly may not be exactly the same as this one.)

1. Locate the Socket 462 on this motherboard. Pull the CPU release lever sideways to unlatch and then raise it all the way up.
2. Align the CPU notch to the socket notch for CPU. Drop the processor with its pin side down into the CPU socket. Do not use extra force to insert CPU; it only fit in one direction. Close the CPU release lever.
3. Remove the plastic film adhesive on the heatsink. Make sure the stepped portion of the heatsink is facing toward the end of the socket that reads "Socket 462". Put the heatsink faces down onto the processor until it covers the processor completely.
4. Push down the short end of the retaining clip first to lock up with the center lug at the bottom of the socket.
5. Use a screwdriver to insert into the slot at the long end of the retaining clip. Push the clip downward to lock up with the center lug at the top of the socket. The heatsink & fan assembly is now firmly attached on the CPU socket.
6. Attach the fan connector of Heatsink & Fan Assembly with the fan connector on the motherboard.

**ATTENTION:** Do not forget to set the correct bus frequency and multiple for your processor.

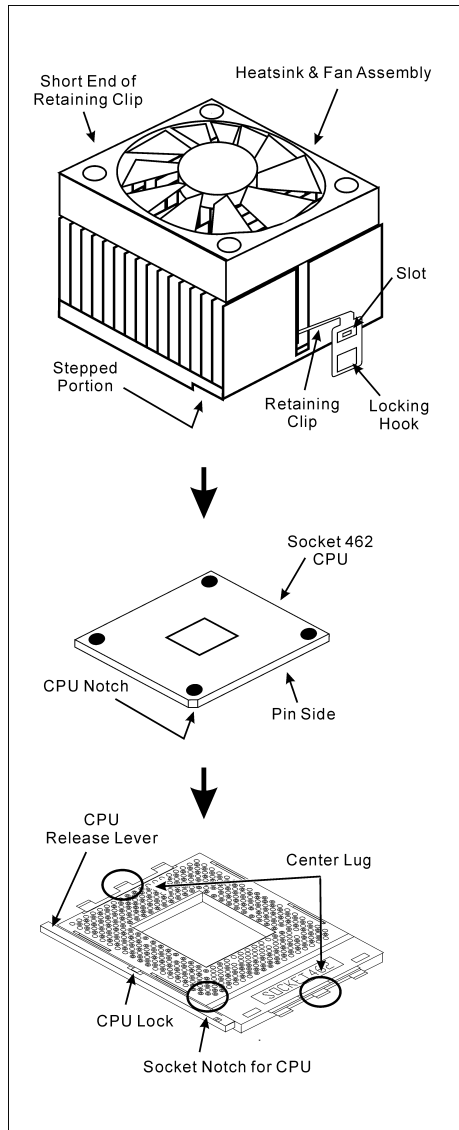

## 2-3. Install System Memory

This motherboard provides 3 184-pin DDR DIMM sites for memory expansion available from minimum 64MB to maximum 3GB.

**Table 2-1. Valid Memory Configurations**

Bank	Memory Module	Total Memory
Bank 0, 1 (DIMM1)	64, 128, 256, 512MB, 1GB	64MB ~ 1GB
Bank 2, 3 (DIMM2)	64, 128, 256, 512MB, 1GB	64MB ~ 1GB
Bank 4, 5 (DIMM3)	64, 128, 256, 512MB, 1GB	64MB ~ 1GB
<b>Total System Memory for Un-buffered &amp; Non-ECC DDR 200/266/333 DIMM</b>		64MB ~ 3GB
<b>Total System Memory for Un-buffered &amp; Non-ECC DDR 400 DIMM</b>		64MB ~ 2GB

**NOTE:** We suggest you to install DDR SDRAM modules from DIMM3 to DIMM1 sockets in order.

Power off the computer and unplug the AC power cord before installing or removing memory modules.

1. Locate the DIMM slot on the board.
2. Hold two edges of the DIMM module carefully, keep away of touching its connectors.
3. Align the notch key on the module with the rib on the slot.
4. Firmly press the module into the slots until the ejector tabs at both sides of the slot automatically snaps into the mounting notch. Do not force the DIMM module in with extra force as the DIMM module only fit in one direction.
5. To remove the DIMM modules, push the two ejector tabs on the slot outward simultaneously, and then pull out the DIMM module.

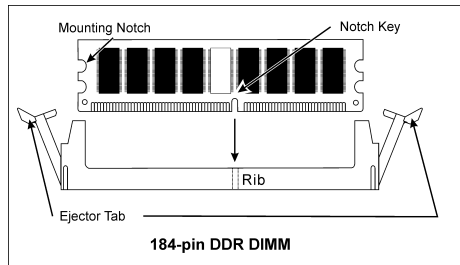

**ATTENTION:** Static electricity can damage the electronic components of the computer or optional boards. Before starting these procedures, ensure that you are discharged of static electricity by touching a grounded metal object briefly.

## 2-4. Connectors, Headers and Switches

Here we will show you all of the connectors, headers and switches, and how to connect them. Please read the entire section for necessary information before attempting to finish all the hardware installation inside the computer chassis. A complete enlarged layout diagram is shown in Chapter 1 for all the position of connectors and headers on the board that you may refer to.

**WARNING:** Always power off the computer and unplug the AC power cord before adding or removing any peripheral or component. Failing to do so may cause severe damage to your motherboard and/or peripherals. Plug in the AC power cord only after you have carefully checked everything.

### (1). ATX Power Input Connectors

This motherboard provides two power connectors to connect to an ATX12V power supply.

NF7/NF7-S/NF7-M:

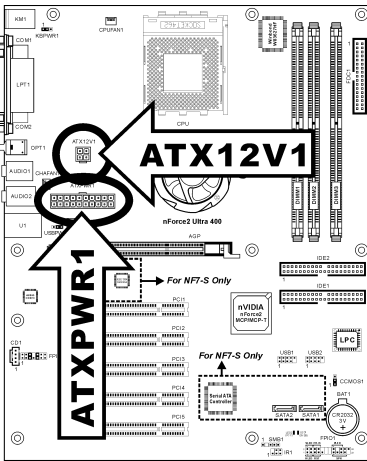

NF7-S2/NF7-S2G:

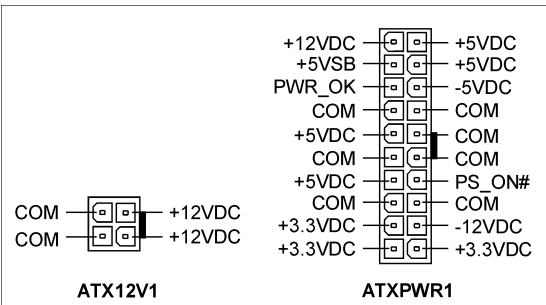
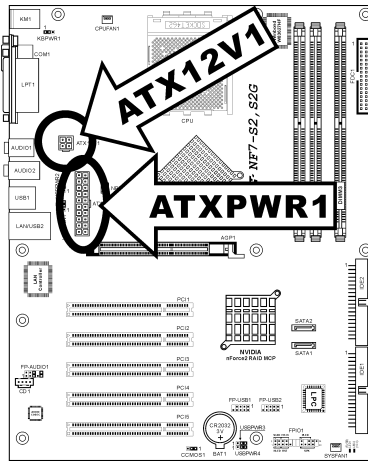

**NOTE:** It is recommended to connect to a power supply with 350W, 20A +5VDC capacity at least for heavily loaded system, and 2A +5VSB capacity at least for supporting wake-up features.

**(2). FAN Connectors**

These 3-pin connectors each provide power to the cooling fans installed in your system.

The CPU must be kept cool by using a powerful fan with heatsink. The system is capable of monitoring the speed of the CPU fan.

- **CPUFAN1:** CPU Fan
- **CHAFAN1/SYSFAN1:** System Fan
- **PWRFAN1:** Auxiliary Fan (NF7/NF7-S/NF7-M)
- **NBFAN1:** Chipset Fan (NF7-S2/NF7-S2G)

**WARNING:** These fan connectors are not jumpers. DO NOT place jumper caps on these connectors.

**NF7/NF7-S/NF7-M:**

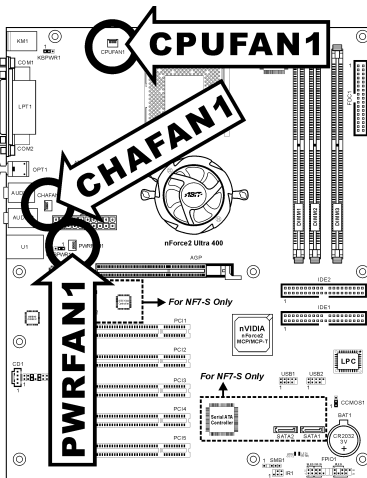

**NF7-S2/NF7-S2G:**

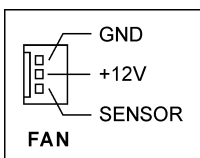
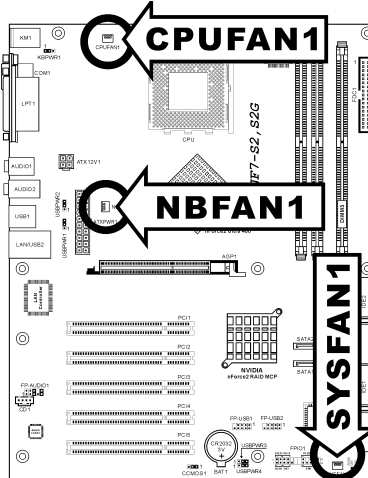

**(3). CMOS Memory Clearing Header**

This header uses a jumper cap to clear the CMOS memory.

- **Pin 1-2 shorted (default):** Normal operation.
- **Pin 2-3 shorted:** Clear CMOS memory.

**WARNING:** Turn the power off first (including the +5V standby power) before clearing the CMOS memory. Failing to do so may cause your system to work abnormally or malfunction.

**NF7/NF7-S/NF7-M:**

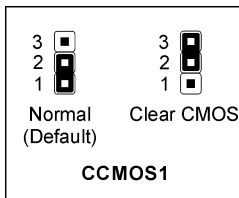
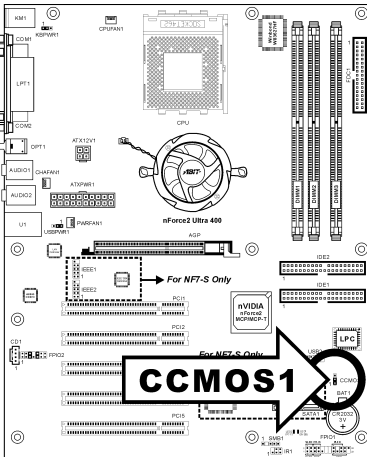

**NF7-S2/NF7-S2G:**

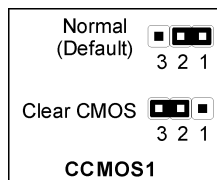
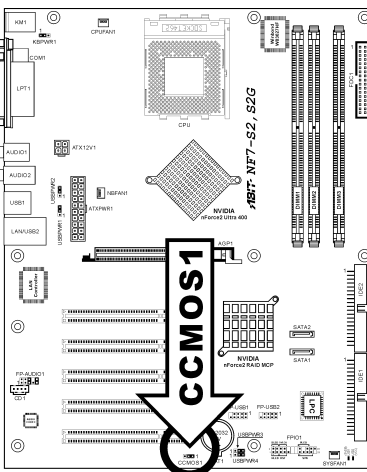



**(4). Wake-up Header**

These headers use a jumper cap to enable/disable the wake-up function.

**NF7/NF7-S/NF7-M:**

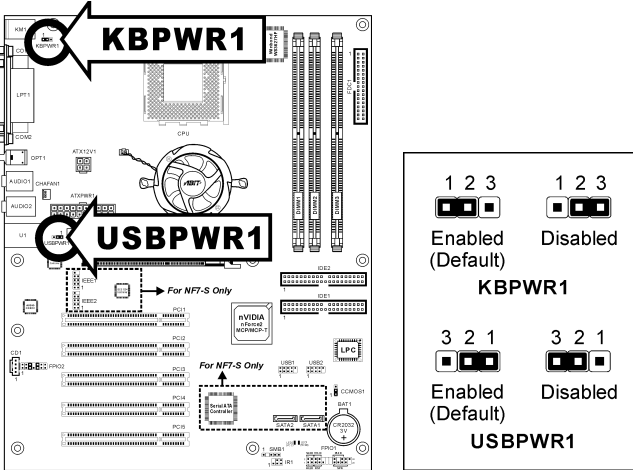

- KBPWR1:**  
 Pin 1-2 shorted (default): Enable wake-up function support at Keyboard/Mouse port.  
 Pin 2-3 shorted: Disable wake-up function support at Keyboard/Mouse port.
- USBPWR1:**  
 Pin 1-2 shorted (default): Enable wake-up function support at USB1 port.  
 Pin 2-3 shorted: Disable wake-up function support at USB1 port.

## NF7-S2/NF7-S2G (Ver. 0.22):

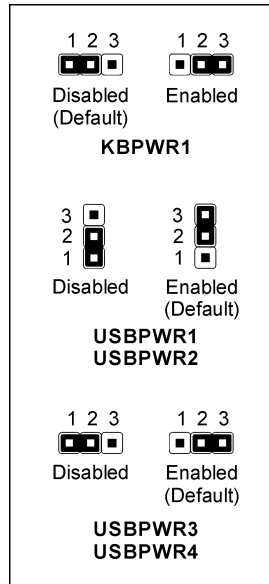
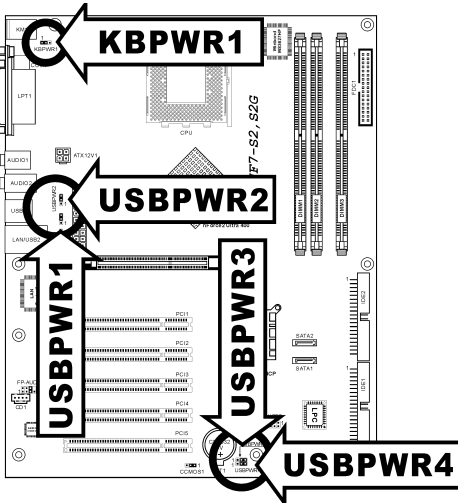

- KBPWR1:**  
 Pin 1-2 shorted (default): Disable wake-up function support at Keyboard/Mouse port.  
 Pin 2-3 shorted: Enable wake-up function support at Keyboard/Mouse port.
- USBPWR1:**  
 Pin 1-2 shorted: Disable wake-up function support at USB2 port.  
 Pin 2-3 shorted (default): Enable wake-up function support at USB2 port.
- USBPWR2:**  
 Pin 1-2 shorted: Disable wake-up function support at USB1 port.  
 Pin 2-3 shorted (default): Enable wake-up function support at USB1 port.
- USBPWR3:**  
 Pin 1-2 shorted: Disable wake-up function support at FP-USB1 port.  
 Pin 2-3 shorted (default): Enable wake-up function support at FP-USB1 port.
- USBPWR4:**  
 Pin 1-2 shorted: Disable wake-up function support at FP-USB2 port.  
 Pin 2-3 shorted (default): Enable wake-up function support at FP-USB2 port.

**(5). Front Panel Switches & Indicators Headers**

This header is used for connecting switches and LED indicators on the chassis front panel.

Watch the power LED pin position and orientation. The mark “+” align to the pin in the figure below stands for positive polarity for the LED connection. Please pay attention to connect these headers. A wrong orientation will only cause the LED not lighting, but a wrong connection of the switches could cause system malfunction.

**NF7/NF7-S/NF7-M:**

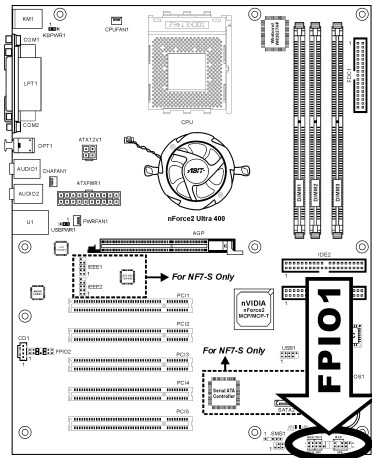

**NF7-S2/NF7-S2G:**

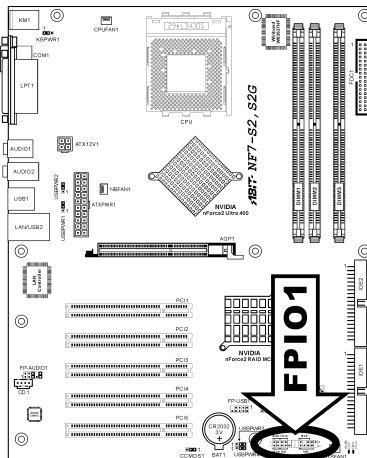

- **HLED (Pin 1, 3):**  
Connects to the HDD LED cable of chassis front panel.
- **RST (Pin 5, 7):**  
Connects to the Reset Switch cable of chassis front panel.
- **SPK (Pin 15, 17, 19, 21):**  
Connects to the System Speaker cable of chassis.
- **SLED (Pin 2, 4):**  
Connects to the Suspend LED cable (if there is one) of chassis front panel.
- **PWR-ON (Pin 6, 8):**  
Connects to the Power Switch cable of chassis front panel.
- **PLED (Pin 16, 18, 20):**  
Connects to the Power LED cable of chassis front panel.

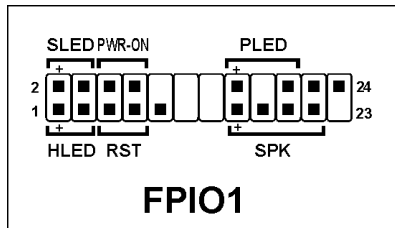

**(6). Infrared Device Header (NF7/NF7-S/NF7-M)**

This header connects to an optional IR device attached to chassis. This motherboard supports standard IR transfer rates.

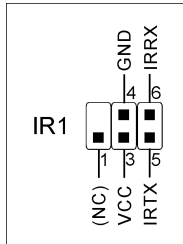
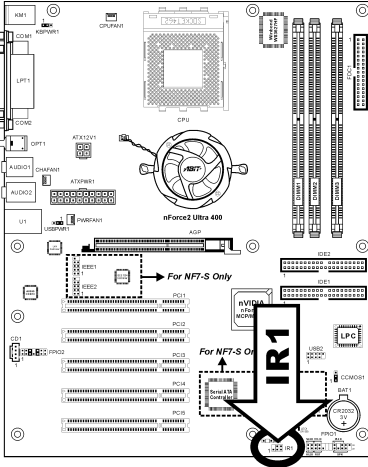

**(7). Additional USB Port Headers**

These headers each provide 2 additional USB 2.0 ports connection through an USB cable designed for USB 2.0 specifications.

**NF7/NF7-S/NF7-M:**

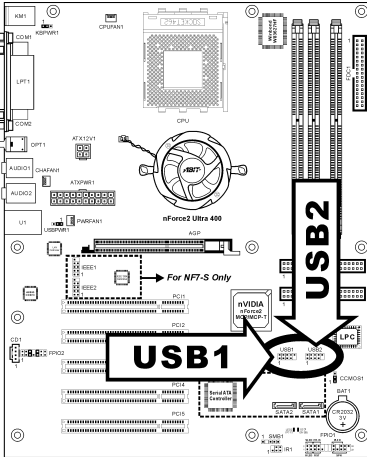

**NF7-S2/NF7-S2G:**

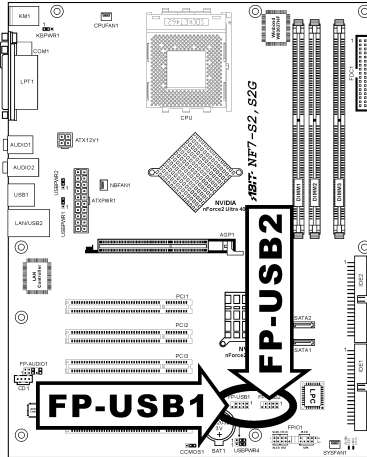

NF7/NF7-S/NF7-M		NF7-S2/NF7-S2G		Pin	Pin Assignment	Pin	Pin Assignment
<p>2 4 6 8 10 1 3 5 7 9 <b>USB1</b> <b>USB2</b></p>		<p>9 7 5 3 1 10 8 6 4 2 <b>FP-USB1</b> <b>FP-USB2</b></p>		1	VCC	2	VCC
				3	Data0 -	4	Data1 -
				5	Data0 +	6	Data1 +
				7	Ground	8	Ground
				9	NC	10	NC

**(8). Additional IEEE1394 Port Headers (NF7-S)**

These headers each provide one additional IEEE1394 port connection through an extension cable and bracket.

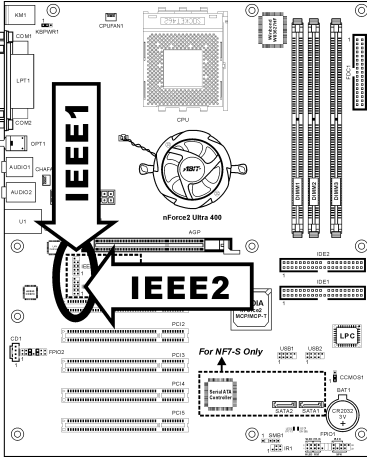

Pin	Pin Assignment	Pin	Pin Assignment
1	TPA0 +	2	TPA0 -
3	GND	4	GND
5	TPB0 +	6	TPB0 -
7	+12V	8	+12V
9	NC	10	GND

**(9). Front Panel Audio Connection Header**

This header provides the connection to audio connector at front panel.

- To use the audio connector at front panel, remove all the jumpers on this header, and then connect to front panel by the extension cable provided with the chassis.
- To use the audio connector at rear panel, disconnect the extension cable, attach the jumpers back at pin 5-6, and pin 9-10 (default setting).

**NF7/NF7-S/NF7-M:**

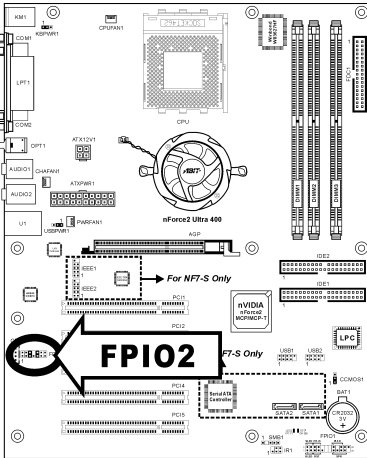

Pin	Pin Assignment	Pin	Pin Assignment
1	Audio Mic.	2	Ground
3	Audio Mic. Bias	4	VCC
5	Speaker Out Right Channel	6	Speaker Out Right Channel Return
7	X	8	NC
9	Speaker Out Left Channel	10	Speaker Out Left Channel Return
11	Ground	12	S/PDIF In
13	VCC	14	S/PDIF Out

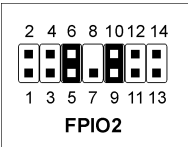

**NF7-S2/NF7-S2G:**

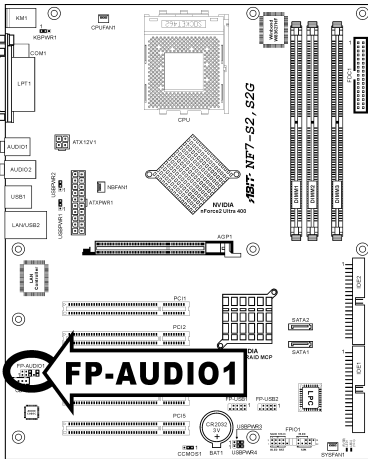

Pin	Pin Assignment	Pin	Pin Assignment
3	Audio Mic. Bias	4	VCC
5	Speaker Out Right Channel	6	Speaker Out Right Channel Return
7	X	8	NC
9	Speaker Out Left Channel	10	Speaker Out Left Channel Return

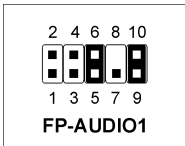



**(10). Internal Audio Connectors**

This connector connects to the audio output of internal CD-ROM drive or add-on card.

**NF7/NF7-S/NF7-M:**

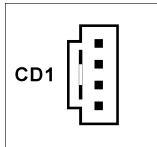
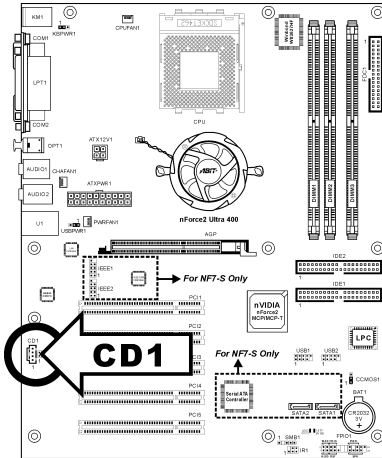

**NF7-S2/NF7-S2G:**

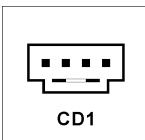
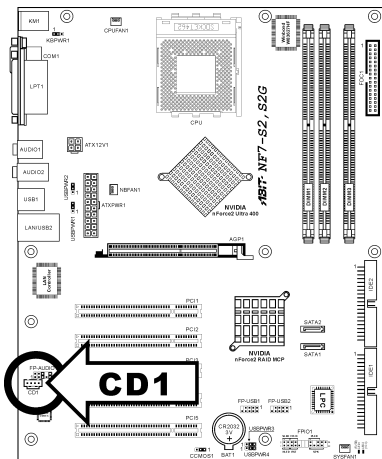

**(11). Accelerated Graphics Port Slot**

This slot supports an optional AGP graphics card up to AGP 8X mode.

**ATTENTION:** This motherboard does not support 3.3V AGP cards. Use only 1.5V or 0.8V AGP cards.

**NF7/NF7-S/NF7-M:**

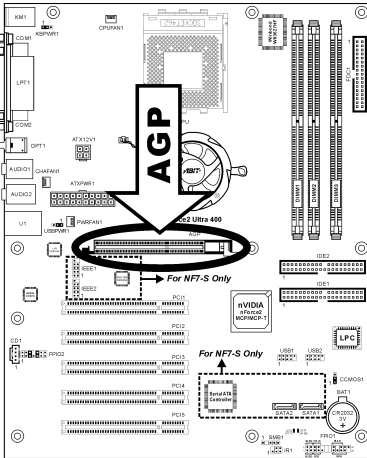

**NF7-S2/NF7-S2G:**

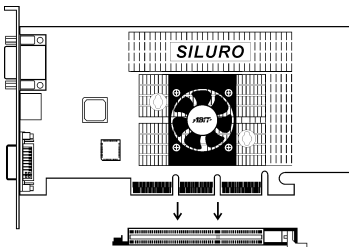
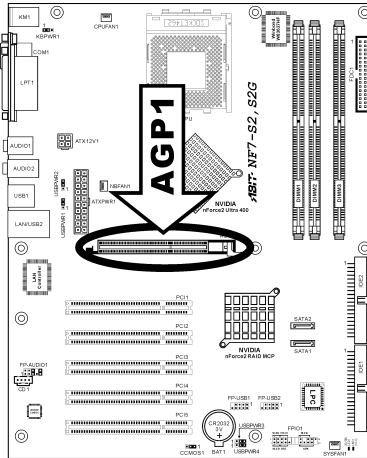

**(12). Floppy Disk Drive Connector**

This connector supports two standard floppy disk drives via a 34-pin 34-conductor ribbon cable.

Connecting the Floppy Disk Drive Cable:

1. Install one end of the ribbon cable into the FDC1 connector. The colored edge of the ribbon cable should be aligned with pin-1 of FDC1 connector.
2. Install the other end(s) of ribbon cable into the disk drive connector(s). The colored edge of the ribbon cable should be also aligned with pin-1 of disk drive connector. The endmost connector should be attached to the drive designated as Drive A.

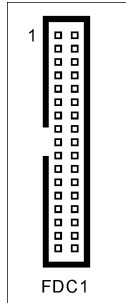

**NF7/NF7-S/NF7-M:**

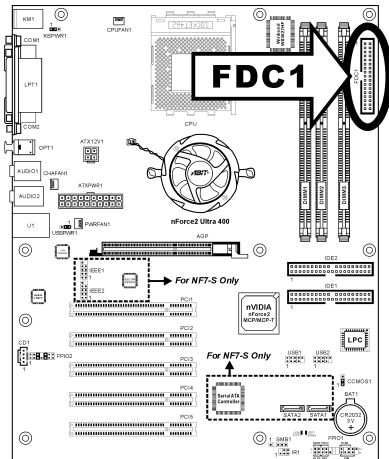

**NF7-S2/NF7-S2G:**

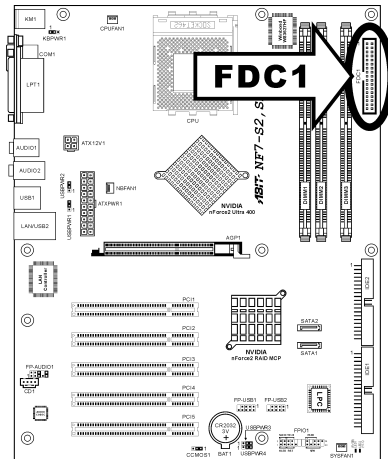

**(13). IDE Connectors**

This motherboard provides two IDE ports to connect up to four IDE drives at Ultra DMA mode by Ultra ATA/66 ribbon cables. Each cable has 40-pin 80-conductor and three connectors, providing two hard drives connection with motherboard. Connect the single end (blue connector) at the longer length of ribbon cable to the IDE port on motherboard, and the other two ends (gray and black connector) at the shorter length of the ribbon cable to the connectors on hard drives.

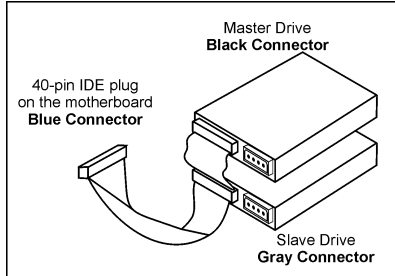

If you want to connect two hard drives together through one IDE channel, you must configure the second drive to Slave mode after the first Master drive. Please refer to the drives' documentation for jumper settings. The first drive connected to IDE1 is usually referred to as "Primary Master", and the second drive as "Primary Slave". The first drive connected to IDE2 is referred to as "Secondary Master" and the second drive as "Secondary Slave".

Keep away from connecting one legacy slow speed drive, like CD-ROM, together with another hard drive on the same IDE channel; this will drop your integral system performance.

**NF7/NF7-S/NF7-M:**

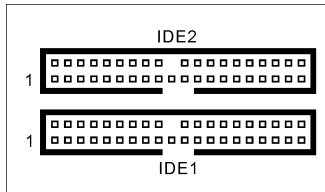
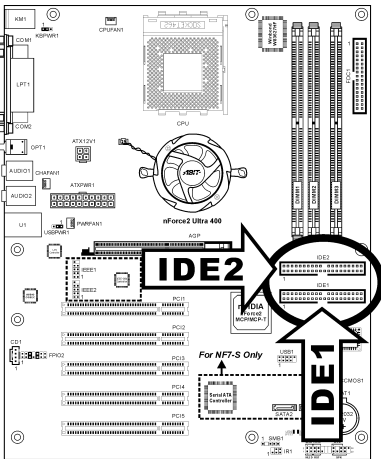

NF7-S2/NF7-S2G:

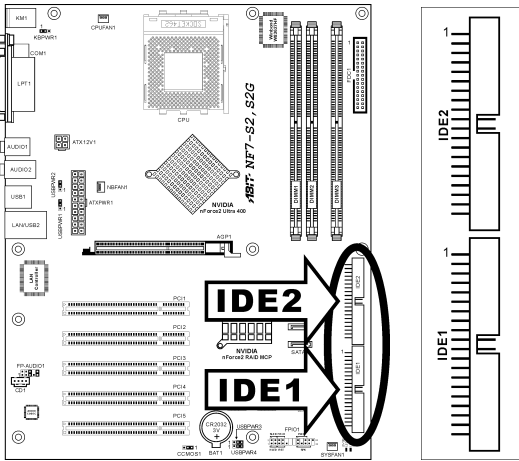

**(14). Serial ATA Connectors (NF7-S/NF7-S2/NF7-S2G)**

These connectors are provided to attach one Serial ATA device at each channel via Serial ATA cable.

**NF7-S:**

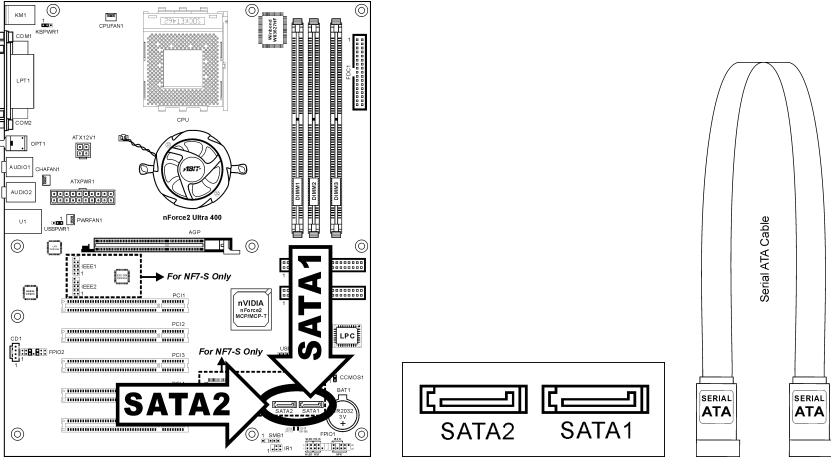

SATA1 and SATA2 are controlled by Silicon Image PCI Chip. To enable the SATA1 and SATA2 controller, the item “Serial ATA Controller” must be kept enabled (default setting) in the BIOS menu of “Onboard PCI Device”.

**NF7-S2/NF7-S2G:**

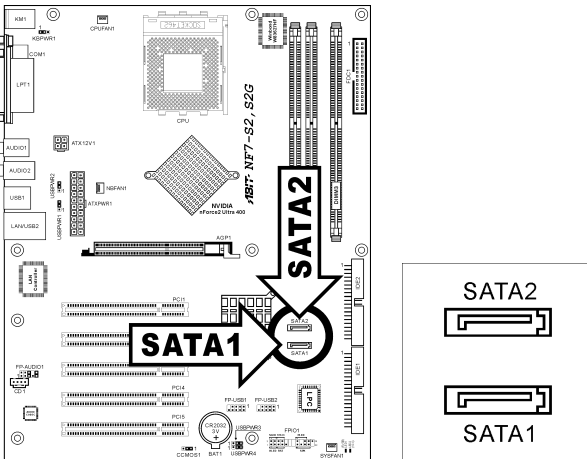

SATA1 and SATA2 are controlled by South Bridge. To enable the SATA1 and SATA2 controller, the item “Serial ATA” must be kept enabled (default setting) in the BIOS menu of “OnChip PCI Device”.

**(15). Status Indicators**

- **LED1 (5VSB):** This LED lights up when the power supply is connected with power source.
- **LED2 (VCC):** This LED lights up when the system power is on.

**NF7/NF7-S/NF7-M:**

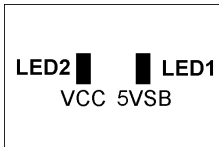
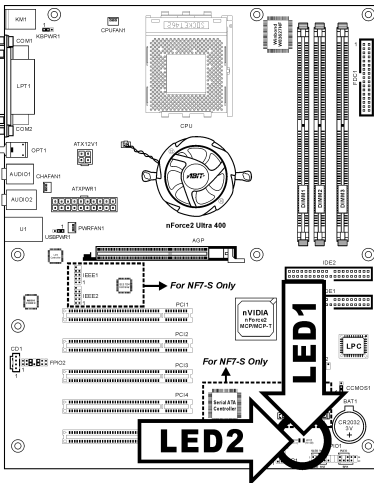

**NF7-S2/NF7-S2G:**

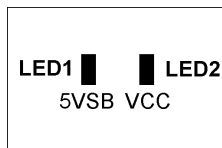
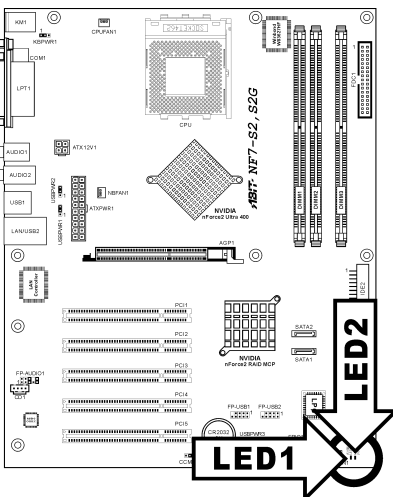

**(16). System Management Bus Headers**

This header is reserved for system management bus (SM bus). The SM bus is a specific implementation of an I<sup>2</sup>C bus. I<sup>2</sup>C is a multi-master bus, which means that multiple chips can be connected to the same bus and each one can act as a master by initiating a data transfer. If more than one master simultaneously tries to control the bus, an arbitration procedure decides which master gets priority.

**NF7/NF7-S/NF7-M:**

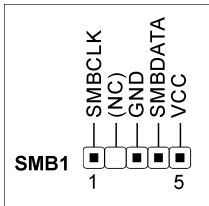
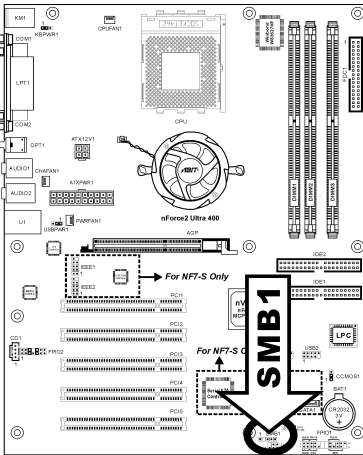

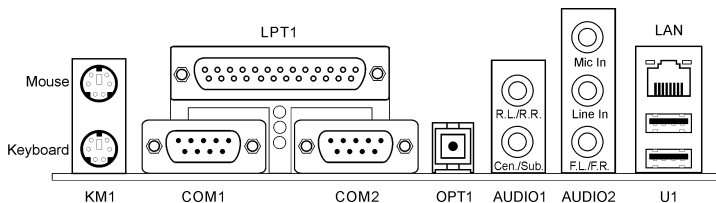
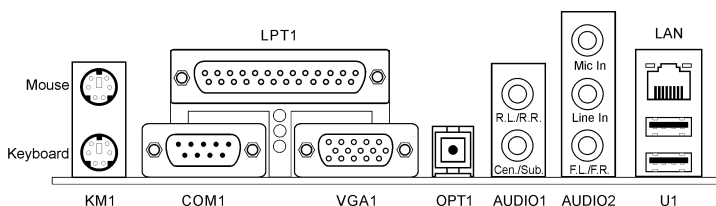
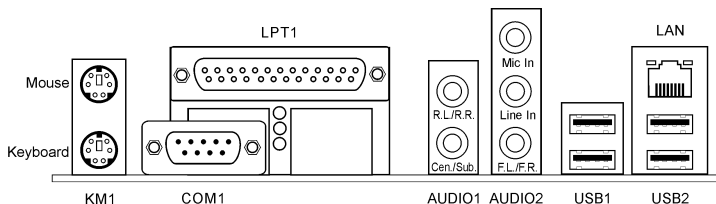

**(17). Back Panel Connectors****NF7/NF7-S:****NF7-M:****NF7-S2/NF7-S2G:**

- **Mouse:** Connects to PS/2 mouse.
- **Keyboard:** Connects to PS/2 keyboard.
- **LPT1:** Connects to printer or other devices that support this communication protocol.
- **COM1:** Connects to external modem, mouse or other devices that support this communication protocol.
- **COM2:** Connects to external modem, mouse or other devices that support this communication protocol. (NF7/NF7-S)
- **VGA1:** Connects to monitor input. (NF7-M)
- **OPT1:** This connector provides an S/PDIF out connection through optical fiber to digital multimedia devices. (NF7/NF7-S/NF7-M)

- **AUDIO1:**
  - R.L./R.R. (Rear Left / Rear Right):** Connects to the rear left and rear right channel in the 5.1 channel audio system.
  - Cen./Sub. (Center / Subwoofer):** Connects to the center and subwoofer channel in the 5.1 channel audio system.
- **AUDIO2:**
  - Mic In:** Connects to the plug from external microphone.
  - Line In:** Connects to the line out from external audio sources.
  - F.L./F.R. (Front Left / Front Right):** Connects to the front left and front right channel in the 5.1-channel or regular 2-channel audio system.
- **LAN:** Connects to Local Area Network.
- **U1/USB1/USB2 (USB Port Connectors):** Connects to USB devices such as scanner, digital speakers, monitor, mouse, keyboard, hub, digital camera, joystick etc.

## Chapter 3. BIOS Setup

This motherboard provides a programmable EEPROM that you can update the BIOS utility. The BIOS (Basic Input/Output System) is a program that deals with the basic level of communication between processor and peripherals. Use the BIOS Setup program only when installing motherboard, reconfiguring system, or prompted to “Run Setup”. This chapter explains the Setup Utility of BIOS utility.

After powering up the system, the BIOS message appears on the screen, the memory count begins, and then the following message appears on the screen:

**PRESS DEL TO ENTER SETUP**

If this message disappears before you respond, restart the system by pressing <Ctrl> + <Alt> + <Del> keys, or by pressing the Reset button on computer chassis. Only when it failed by these two methods can you restart the system by powering it off and then back on.

After pressing <Del> key, the main menu screen appears.

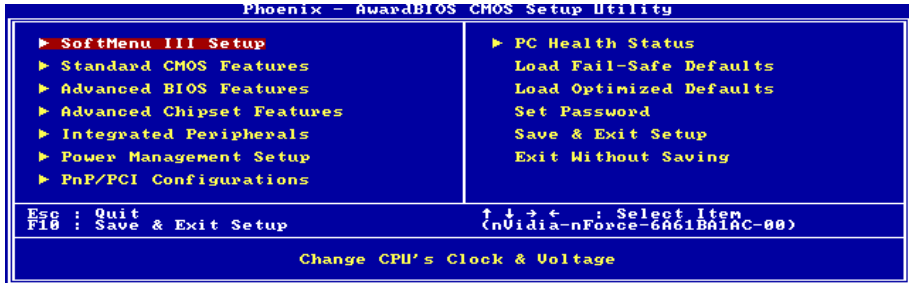

**NOTE:** In order to increase system stability and performance, our engineering staffs are constantly improving the BIOS menu. The BIOS setup screens and descriptions illustrated in this manual are for your reference only, may not completely match what you see on your screen.

In the BIOS Setup main menu, you can see several options. We will explain these options step by step in the following pages of this chapter, but let us first see a short description of the function keys you may use here.

### Esc:

Press this button to quit the BIOS Setup.

### ↑ ↓ → ←:

Press these buttons to choose, in the main menu, the option you want to confirm or to modify.

### F10:

When you have completed the setup of BIOS parameters, press this button to save these parameters and to exit the BIOS Setup menu.

## 3-1. SoftMenu Setup

The SoftMenu utility is ABIT's exclusive and ultimate solution in programming the CPU operating speed. All the parameters regarding CPU FSB speed, multiplier factor, the AGP & PCI clock, and even the CPU core voltage are all available at your fingertips.

↳ **For NF7/NF7-S/NF7-M:**

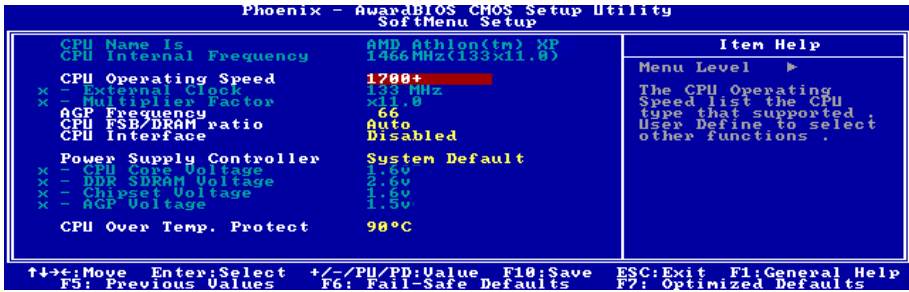

### CPU Name Is:

This item displays the CPU model name, for example: AMD Athlon(tm) XP.

### CPU Internal Frequency:

This item displays the CPU internal clock speed.

### CPU Operating Speed:

This item displays the CPU operating speed according to the type and speed of your CPU. You can also select the [User Define] option to enter the manual option.

### User Define:

**WARNING:** The wrong settings of the multiplier and external clock in certain circumstances may cause CPU damage. Setting the working frequency higher than the PCI chipset or processor specs, may cause abnormal memory module functioning, system hangs, hard disk drive data lose, abnormal functioning of the VGA card, or abnormal functioning with other add-on cards. Using non-specification settings for your CPU is not the intention of this explanation. These should be used for engineering testing, not for normal applications.

There will be no guaranty for the settings beyond specification, any damage of any component on this motherboard or peripherals result therein is not our responsibility.

### \* **External Clock:**

This item sets the CPU Front Side Bus speed from 100 to 300. Due to the specification limit of the CPU you installed, the speed you set over its standard bus speed is supported, but not guaranteed.

---

**\* Multiplier Factor:**

This item sets the multiplier factor for the CPU you installed.

**NOTE:** Some processors might have this multiplier factor locked, so there is no way to choose a higher multiplier factor.

---

**AGP Frequency:**

This item allows you to set the AGP clock speed from 66MHz to 99MHz. Due to the AGP specification limit, the speed you set over its standard clock speed is supported, but not guaranteed.

---

**CPU FSB/DRAM ratio:**

This item allows you to set the frequency ratio between CPU and DRAM. The default setting is *Auto*. Choose *By SPD* to let the BIOS read the DRAM module SPD data and set to the values stored in it. When set to *Auto*, if the DRAM Clock frequency is above the FSB frequency, the FSB and the DRAM Clock will automatically run in synchronous mode to achieve higher performance.

---

**CPU Interface:**

Two options are available: Disabled → Enabled. The default setting is *Disabled*. When set to *Disabled*, the system uses the most stable CPU/FSB parameters. If you choose *enabled*, the system will use overclocked CPU/FSB parameters.

---

**Power Supply Controller:**

This option allows you to switch between the default and user-defined voltages. Leave this setting to default unless the current voltage setting cannot be detected or is not correct. The option “**User Define**” enables you to select the following voltages manually.

**\* CPU Core Voltage:**

This item selects the CPU core voltage.

**\* DDR SDRAM Voltage:**

This item selects the voltage for DRAM slot.

**\* Chipset Voltage:**

This item selects the Chipset voltage.

**\* AGP Voltage:**

This item selects the voltage for AGP slot.

**ATTENTION:** A wrong voltage setting may cause the system unstable or even damage the CPU. Please leave it to default settings unless you are fully aware of its consequences.

---

**CPU Over Temp. Protect:**

This item sets the temperature that would shutdown the system automatically in order to prevent CPU overheats.

---

## ↳ For NF7-S2/NF7-S2G:

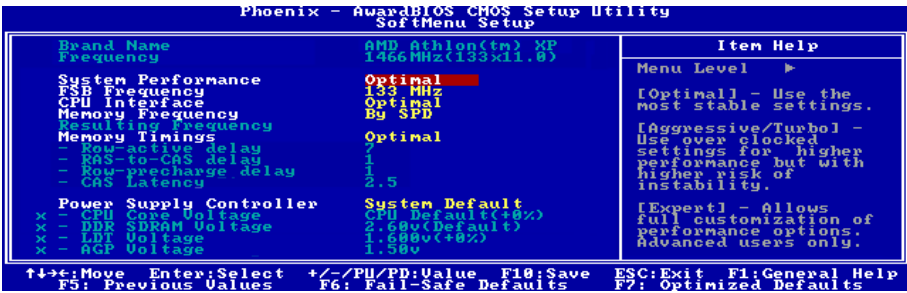

### Brand Name:

This item displays the CPU model name, for example: AMD Athlon(tm) XP.

### Frequency:

This item displays the CPU internal clock speed.

### System Performance:

Four options are available: Optimal → Aggressive → Turbo → Expert. The default setting is *Optimal*. Choose *Optimal* to use most stable settings; choose *Aggressive/Turbo* to use overclocked settings; choose *Expert* for user-define.

### FSB Frequency:

This item sets the CPU Front Side Bus speed from 100 to 300. Due to the specification limit of the CPU you installed, the speed you set over its standard bus speed is supported, but not guaranteed.

### CPU Interface:

Two options are available: Optimal → Aggressive. The default setting is *Optimal*. When set to *Optimal*, the system uses the most stable CPU/FSB parameters. If you choose *Aggressive*, the system will use overclocked CPU/FSB parameters.

### Memory Frequency:

This item allows you to set the DRAM frequency. When set to *By SPD*, the BIOS will read the DRAM module SPD data and automatically set to the values stored in it.

### Resulting Frequency:

This item will show you the current DRAM bus speed.

### Memory Timings:

Four options are available: Optimal → Aggressive → Turbo → Expert. The default setting is *Optimal*. Choose *Optimal* for better memory compatibility; choose *Aggressive/Turbo* for better memory performance; choose *Expert* for user-define.

### NF7 Series

---

※ **Row-active delay:**

Fifteen options are available: from 1 to 15. This option specifies the row active time. This is the minimum number of cycles between an activate command and a precharge command to the same bank.

※ **RAS-to-CAS delay:**

Seven options are available: from 1 to 7. This item is to set SDR/DDR SDRAM RAS to CAS delay. It can define the SDRAM ACT to Read/Write command period.

※ **Row-precharge delay:**

Seven options are available: from 1 to 7. This item controls the idle clocks after issuing a precharge command to the DRAM.

※ **CAS Latency Time:**

Three options are available: 2.0 → 2.5 → 3.0. The default setting is 2.5. You can select SDRAM CAS (Column Address Strobe) latency time according your SDRAM specification.

---

**Power Supply Controller:**

This option allows you to switch between the default and user-defined voltages. Leave this setting to default unless the current voltage setting cannot be detected or is not correct. The option “**User Define**” enables you to select the following voltages manually.

※ **CPU Core Voltage:**

This item selects the CPU core voltage.

※ **DDR SDRAM Voltage:**

This item selects the voltage for DRAM slot.

※ **LDT Voltage:**

This item selects the LDT voltage.

※ **AGP Voltage:**

This item selects the voltage for AGP slot.

**ATTENTION:** A wrong voltage setting may cause the system unstable or even damage the CPU. Please leave it to default settings unless you are fully aware of its consequences.

## 3-2. Standard CMOS Features

This section contains the basic configuration parameters of the BIOS. These parameters include date, hour, VGA card, FDD and HDD settings.

NF7/NF7-S/NF7-M:



NF7-S2/NF7-S2G:



### Date (mm:dd:yy):

This item sets the date you specify (usually the current date) in the format of [Month], [Date], and [Year].

### Time (hh:mm:ss):

This item sets the time you specify (usually the current time) in the format of [Hour], [Minute], and [Second].

### IDE Primary/Channel 1 Master/Slave, IDE Secondary/Channel 2 Master/Slave, IDE Channel 3/4 Master:

Click <Enter> key to enter its submenu:



## NF7/NF7-S/NF7-M:

Phoenix - AwardBIOS CMOS Setup Utility		Item Help
IDE HDD Auto-Detection		
IDE Primary Master	Auto	Menu Level >>
Access Mode	Auto	To auto-detect the HDD's size, head... on this channel
Capacity	4375 MB	
Cylinder	9842	
Head	15	
Precomp	8	
Landing Zone	9841	
Sector	63	

↑←→: Move    Enter: Select    +/~/PU/PD: Value    F10: Save    ESC: Exit    F1: General Help  
 F5: Previous Values    F6: Fail-Safe Defaults    F7: Optimized Defaults

## NF7-S2/NF7-S2G:

Phoenix - AwardBIOS CMOS Setup Utility		Item Help
IDE Channel 1 Master		
IDE Channel 1 Master	Auto	Menu Level >>
Access Mode	Auto	To auto-detect the HDD's size, head... on this channel
Capacity	41176 MB	
Cylinder	19718	
Head	16	
Precomp	8	
Landing Zone	19789	
Sector	255	

↑←→: Move    Enter: Select    +/~/PU/PD: Value    F10: Save    ESC: Exit    F1: General Help  
 F5: Previous Values    F6: Fail-Safe Defaults    F7: Optimized Defaults

**IDE HDD Auto-Detection:**

This item allows you to detect the parameters of IDE drives by pressing <Enter> key. The parameters will be shown on the screen automatically.

**IDE Primary/Channel 1 Master/Slave, IDE Secondary/Channel 2 Master/Slave, IDE Channel 3/4 Master:**

When set to [Auto], the BIOS will automatically check what kind of IDE drive you are using. If you want to define your own drive by yourself, set it to [Manual] and make sure you fully understand the meaning of the parameters. Please refer to the instruction manual provided by the device's manufacturer to get the setting right.

**Access Mode:**

This item selects the mode to access your IDE devices. Leave this item to its default [Auto] setting to detect the access mode of your HDD automatically.

**Capacity:**

This item displays the approximate capacity of the disk drive. Usually the size is slightly greater than the size of a formatted disk given by a disk-checking program.

**Cylinder:**

This item configures the numbers of cylinders.

---

**Head:**

This item configures the numbers of read/write heads.

---

**Precomp:**

This item displays the number of cylinders at which to change the write timing.

---

**Landing Zone:**

This item displays the number of cylinders specified as the landing zone for the read/write heads.

---

**Sector:**

This item configures the numbers of sectors per track.

** Back to Standard CMOS Features Setup Menu:**

---

**Drive A & Drive B:**

This item sets the type of floppy drives (usually only Drive A) installed.

---

**Floppy 3 Mode Support:**

This item allows you to use "3 Mode Floppy Drive" in Japanese computer system by selecting drive A, B, or both. Leave this item to its default [Disabled] setting if you are not using this Japanese standard floppy drive.

---

**Video:**

This item selects the type of video adapter used for the primary system monitor.

**[EGA/VGA]:** (Enhanced Graphics Adapter/Video Graphics Array) For EGA, VGA, SVGA and PGA monitor adapters.

**[CGA 40]:** (Color Graphics Adapter) Power up in 40-column mode.

**[CGA 80]:** (Color Graphics Adapter) Power up in 80-column mode.

**[Mono]:** (Monochrome adapter) Includes high-resolution monochrome adapters.

---

**Halt On:**

This item determines whether the system stops if an error is detected during system boot-up.

**[All Errors]:** The system-boot will stop whenever the BIOS detect a non-fatal error.

**[No Errors]:** The system-boot will not stop for any error detected.

**[All, But Keyboard]:** The system-boot will stop for all errors except a keyboard error.

**[All, But Diskette]:** The system-boot will stop for all errors except a diskette error.

---

---

**[All, But Disk/Key]:** The system-boot will stop for all errors except a diskette or keyboard error.

---

**Base Memory:**

This item displays the amount of base memory installed in the system. The value of the base memory is typically 640K for system with 640K or more memory size installed on the motherboard.

---

**Extended Memory:**

This item displays the amount of extended memory detected during system boot-up.

---

**Total Memory:**

This item displays the total memory available in the system.

### 3-3. Advanced BIOS Features



#### Hard Disk Boot Priority: (NF7-S2/NF7-S2G)

This item selects the hard disks booting priority. By pressing <Enter> key, you can enter its submenu where the hard disks detected can be selected for the booting sequence to boot up system.

This item functions only when there is the option of [Hard Disk] in any one of the First/Second/Third Boot Device items.

#### \* **Bootable Add-in Device:**

This item allows you to select the add-in device priority between [PCI Slot Device] and [Onchip SATA].

#### Removable Device Priority: (NF7-S2/NF7-S2G)

This item allows you to select the booting priority of removable devices.

#### CD-ROM Boot Priority: (NF7-S2/NF7-S2G)

This item allows you to select the booting priority of CD-ROM devices.

**NOTE:** This item appears only if you install CD-ROM devices to your computer.

#### Virus Warning: (NF7/NF7-S/NF7-M)

When set to [Enabled], the BIOS will monitor the boot sector and partition table of the hard disk drive. If there is any attempt of writing to the boot sector or partition table of the hard disk drive, the BIOS will halt the system and an error message will appear.

#### Quick Power On Self Test:

When set to [Enabled], this item speeds up the Power On Self Test (POST) after powering on the system. The BIOS shorten or skip some check during the POST.

#### First Boot Device / Second Boot Device / Third Boot Device / Boot Other Device:

Select the drive to boot first, second and third in the [First Boot Device], [Second Boot Device], and [Third Boot Device] items respectively. The BIOS will boot the operating system according to the

---

sequence of the drive selected. Set [Boot Other Device] to [Enabled] if you wish to boot from another device other than these three items.

---

#### **Swap Floppy Drive:**

This item can be set as Disabled or Enabled. The default setting is *Disabled*. When this feature is enabled, you don't need to open the computer case to swap the position of floppy disk drive connectors. Drive A can be set as drive B and drive B can be set as drive A.

---

#### **Boot Up Floppy Seek:**

When the computer boots up, the BIOS detects if the system has a FDD or not. When this item is set to *Disabled*, if the BIOS detects no floppy drive, it will display a floppy disk drive error message. If this item is disabled, the BIOS will skip this test. The default setting is *Disabled*.

---

#### **Boot Up NumLock Status:**

This item determines the default state of the numeric keypad at system booting up.

**[On]:** The numeric keypad functions as number keys.

**[Off]:** The numeric keypad functions as arrow keys.

---

#### **Security Option:**

This item determines when the system will prompt for password - every time the system boots or only when enters the BIOS setup.

**[Setup]:** The password is required only when accessing the BIOS Setup.

**[System]:** The password is required each time the computer boots up.

To disable security, select *Set Supervisor Password* at main menu and then you will be asked to enter the password. Do not type anything and just press the <Enter> key and it will disable security. Once security is disabled, the system will boot and you can enter the *BIOS setup menu* freely.

**NOTE:** Don't forget your password. If you forget the password, you will have to open the computer case and clear all information in the CMOS before you can start up the system. But by doing this, you will have to reset all previously set options.

---

#### **APIC Mode:**

Leave this item to its default setting.

##### **\* MPS Version Ctrl For OS:**

This item specifies which version of MPS (Multi-Processor Specification) this motherboard will use. The options are 1.1 and 1.4. The default setting is *1.4*. If you use an older OS for dual processor executing, please set this option to 1.1.

---

#### **OS Select For DRAM > 64MB:**

This item allows you to access the memory that is over 64MB in OS/2. Leave this item to its default [Non-OS2] setting for operating system other than OS/2.

---

**Report No FDD For OS:**

When set to [Enabled], this item allows you to run some older operating system without floppy disk drive. Leave this item to its default setting.

---

**Delay IDE Initial:**

This item allows the BIOS to support some old or special IDE devices by prolonging this delay time. A larger value will give more delay time to the device for which to initialize and to prepare for activation.

---

**Full Screen LOGO Show: (NF7-S2/NF7-S2G)**

This item determines to show the full screen logo when booting.

## 3-4. Advanced Chipset Features

↳ For NF7/NF7-S/NF7-M:



### Memory Timings:

Five options are available: *Optimal* → *Aggressive* → *Turbo* → *By SPD* → *Expert*. The default setting is *Optimal*. Choose *Optimal* for better memory compatibility; choose *Aggressive/Turbo* for better memory performance; choose *Expert* for user-define. When set to *By SPD*, the BIOS will read the DRAM module SPD data and automatically set to the values stored in it.

#### \* Row-active delay:

Fifteen options are available: from 1 to 15. This option specifies the row active time. This is the minimum number of cycles between an activate command and a precharge command to the same bank.

#### \* RAS-to-CAS delay:

Seven options are available: from 1 to 7. This item is to set SDR/DDR SDRAM RAS to CAS delay. It can define the SDRAM ACT to Read/Write command period.

#### \* Row-precharge delay:

Seven options are available: from 1 to 7. This item controls the idle clocks after issuing a precharge command to the DRAM.

#### \* CAS Latency Time:

Three options are available: 2.0 → 2.5 → 3.0. The default setting is 2.5. You can select SDRAM CAS (Column Address Strobe) latency time according your SDRAM specification.

### System BIOS Cacheable:

Two options are available: Disabled or Enabled. The default setting is *Enabled*. When you select *Enabled*, you get faster system BIOS executing speed via the L2 cache.

**Video RAM Cacheable:**

Two options are available: Disabled or Enabled. The default setting is *Enabled*. When you select *Enabled*, you get faster video RAM executing speed via the L2 cache. You must check your VGA adapter manual to find out if any compatibility problems will occur.

---

**AGP Aperture Size:**

This option specifies the amount of system memory that can be used by the AGP device. The aperture is a portion of the PCI memory address range dedicated for graphics memory address space.

---

**Frame Buffer Size: (For NF7-M only)**

Six options are available: 8M → 16M → 32M → 64M → 128M → Disabled. The default setting is 32M. This item can let you select the frame buffer memory size for onboard VGA accelerator.

---

**FSB Spread Spectrum:**

Three options are available: Disabled → 0.50% → 1.00%. The default setting is 0.50%.

---

**AGP Spread Spectrum:**

Two options are available: Disabled → 0.50%. The default setting is 0.50%.

---

**CPU Thermal-Throttling:**

Eight options are available: Disabled → 87.5% → 75.0% → 62.5% → 50.0% → 37.5% → 25.0% → 12.5%. The default setting is 50.0%.

---

**Enhance PCI Performance:**

Two options are available: Disabled → Enabled. The default setting is *Disabled*. This item can improve the PCI transmission performance.

---

**CPU Disconnect Function:**

When set to [Enabled], the system will disconnect the S2K FSB on a C1 state change.

---

**Auto Precharge Write:**

Two options are available: Disabled → Enabled. The default setting is *Disabled*.

---

**AGP Data Transfer Rate:**

This item selects the data transfer rate of AGP device. A higher rate delivers faster and better graphics to your system. Make sure your graphics card supports the mode you select.

---

**AGP Fast Write Capability:**

Two options are available: Disabled → Enabled. The default setting is *Enabled*. If your AGP adapter can support this function, then you can choose *Enabled*. Otherwise, choose *Disabled*.

---

---



## ↳ For NF7-S2/NF7-S2G:

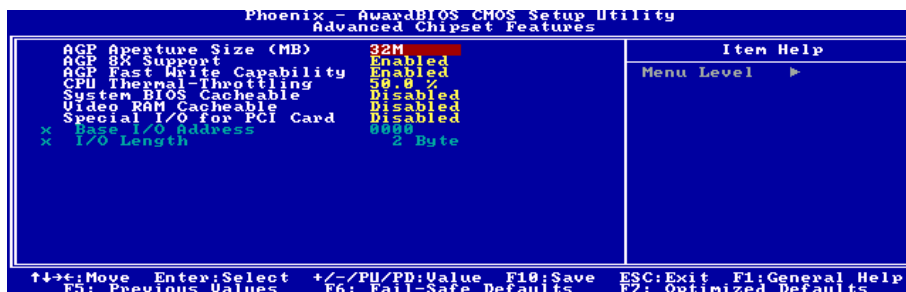

### AGP Aperture Size (MB):

This option specifies the amount of system memory that can be used by the AGP device. The aperture is a portion of the PCI memory address range dedicated for graphics memory address space.

### AGP 8X Support:

This item allows you to enable or disable AGP 8X support

### AGP Fast Write Capability:

Two options are available: Disabled → Enabled. The default setting is *Enabled*. If your AGP adapter can support this function, then you can choose *Enabled*. Otherwise, choose *Disabled*.

### CPU Thermal-Throttling:

Eight options are available: Disabled → 87.5% → 75.0% → 62.5% → 50.0% → 37.5% → 25.0% → 12.5%. The default setting is *50.0%*.

### System BIOS Cacheable:

Two options are available: Disabled or Enabled. When you select *Enabled*, you get faster system BIOS executing speed via the L2 cache.

### Video RAM Cacheable:

Two options are available: Disabled or Enabled. When you select *Enabled*, you get faster video RAM executing speed via the L2 cache. You must check your VGA adapter manual to find out if any compatibility problems will occur.

### Special I/O for PCI Card:

Two options are available: Disabled or Enabled. When set to *Enabled*, the “Base I/O Address” and “I/O Length” items will be available to configure, allowing you to assign specific I/O address for the PCI card.

## 3-5. Integrated Peripherals

↳ For NF7/NF7-S/NF7-M:



### OnChip IDE Device:

Click <Enter> key to enter its submenu:

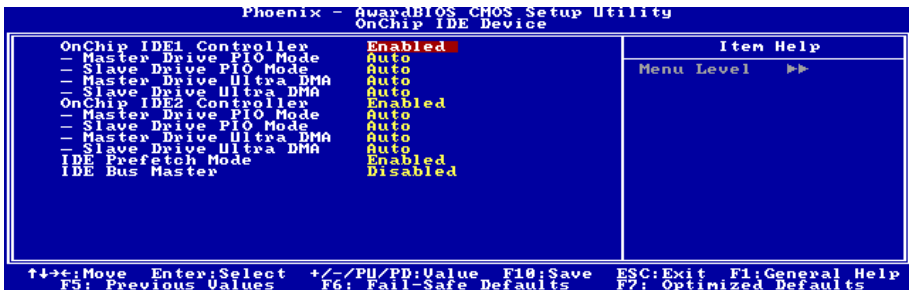

### OnChip IDE1 Controller:

This item allows you to enable or disable the primary and secondary IDE controller. Select [Disabled] if you want to add a different hard drive controller.

#### \* Master/Slave Drive PIO Mode

The PIO (Programmed Input/Output) mode allows the BIOS to tell the controller what it wants and then let the controller and the CPU perform the complete task, rather than having the BIOS issue a series of commands to affect a transfer to or from the disk drive.

[Auto]: The BIOS will select the best available mode after checking your disk drive.

[Mode 0-4]: You can select a mode that matches your disk drive's timing. Do not use the wrong setting or you will have drive errors.

#### \* Master/Slave Drive Ultra DMA

This item allows you to set the Ultra DMA in use.

**[Auto]:** The BIOS will select the best available option after checking your hard drive or CD-ROM.

**[Disabled]:** The BIOS will not detect these categories. If problem arises in using Ultra DMA devices, try disabling this item.

---

### **OnChip IDE2 Controller:**

The description is same as the *OnChip IDE1 Controller*.

---

### **IDE Prefetch Mode:**

Two options are available: Disabled or Enabled. The default setting is *Enabled*. The onboard IDE drive interfaces supports IDE prefetching for faster drive accesses. If you install a primary and/or secondary add-in IDE interface, set this field to *Disabled* if the interface does not support prefetching.

---

### **IDE Bus Master:**

This option enables or disables the IDE bus mastering capability under the DOS environment.

## **Back to Integrated Peripherals Setup Menu:**

---

### **OnChip PCI Device:**

Click <Enter> key to enter its submenu:

```

Phoenix - AwardBIOS CMOS Setup Utility
OnChip PCI Device
-----
USB Controller          U1.1+V2.0
- USB Keyboard Support via OS
- USB Mouse Support via OS
- USB2.0 Device Compatible Disabled
Audio Controller       Enabled
LAN Controller         Enabled
- LAN Boot ROM         Disabled
IEEE1394 Controller    Enabled
-----
Item Help
Menu Level  >>>
-----
↑↓→←: Move  Enter: Select  +/-/PU/PD: Value  F10: Save  ESC: Exit  F1: General Help
F5: Previous Values  F6: Fail-Safe Defaults  F7: Optimized Defaults

```

---

### **USB Controller:**

Three options are available: Disabled → V1.1+V2.0 → V1.1. The default setting is *V1.1+V2.0*. If you choose to disable this item, the “**USB Keyboard Support**” and “**USB Mouse Support**” items will not be able to select in *Integrated Peripherals* menu.

\* **USB Keyboard Support via:**

This item allows you to select [**BIOS**] for using USB keyboard in DOS environment, or [**OS**] in OS environment.

\* **USB Mouse Support via:**

This item allows you to select [**BIOS**] for using USB mouse in DOS environment, or [**OS**] in OS environment.

\* **USB2.0 Device Compatible:**

This item enables or disables the compatibility with USB2.0 devices.

**Audio Controller:**

This option enables or disables the audio controller.

**LAN Controller:**

This option enables or disables the LAN controller.

\* **LAN Boot ROM:**

This item allows you to use the boot ROM (instead of a disk drive) to boot-up the system and access the local area network directly.

**IEEE1394 Controller (For NF7-S Only):**

This option enables or disables the IEEE 1394 controller.

↵ **Back to Integrated Peripherals Setup Menu:****Onboard PCI Device (For NF7-S Only):**

Click <Enter> key to enter its submenu:

**Serial ATA Controller:**

This option enables or disables the onboard Silicon Image SIL3112A SATA controller.

\* **SATA RAID ROM:**

This item allows you to use the boot ROM of onboard Serial ATA RAID to boot-up system.

↵ **Back to Integrated Peripherals Setup Menu:****Init Display First:**

This item selects to initialize AGP or PCI Slot first when the system boots.

[PCI Slot]: When the system boots, it will first initialize PCI.

[AGP]: When the system boots, it will first initialize AGP.

---

**EXT-P2P's Discard Time:**

This item allows you to set EXT-P2P's discard time.

---

**Onboard FDD Controller:**

Two options are available: Enabled and Disabled. The default setting is *Enabled*. You can enable or disable the onboard FDD controller.

---

**Onboard Serial Port 1:**

This is used to specify the I/O address and IRQ of Serial Port 1. Six options are available: Disabled → 3F8/IRQ4 → 2F8/IRQ3 → 3E8/IRQ4 → 2E8/IRQ3 → AUTO. The default setting is *3F8/IRQ4*.

---

**Onboard Serial Port 2:**

This is used to specify the I/O address and IRQ of Serial Port 2. Six options are available: Disabled → 3F8/IRQ4 → 2F8/IRQ3 → 3E8/IRQ4 → 2E8/IRQ3 → AUTO. The default setting is *2F8/IRQ3*.

If you choose *Disabled*, the following items will not be available to set.

※ **Onboard IR Function:**

Three options are available: IrDA (HPSIR) → ASKIR (Amplitude Shift Keyed IR) → Disabled. The default setting is *Disabled*.

When you select the item IrDA or ASKIR, the following items will be available to set.

※ **RxD , TxD Active:**

Four options are available: Hi, Hi → Hi, Lo → Lo, Hi → Lo, Lo. The default setting is *Hi, Lo*. Set IR transmission/reception polarity as High or Low.

※ **IR Transmission Delay:**

Two options are available: Enabled and Disabled. The default setting is *Enabled*. Set IR transmission delays 4 character-time (40 bit-time) when SIR is changed from RX mode to TX mode.

※ **IR Function Duplex:**

Two options are available: Full and Half. The default setting is *Half*. Select the value required by the IR device connected to the IR port. Full-duplex mode permits simultaneous two-direction transmission. Half-duplex mode permits transmission in only one direction at a time.

※ **Use IR Pins:**

Two options are available: RxD2, TxD2 and IR-Header. The default setting is *IR-Header*. If you choose *RxD2, TxD2*, your motherboard must support a COM port IR KIT connection. Otherwise, you can only choose the *IR-Header* to use the IR header on your motherboard to connect your IR KIT. Please use the default setting.

**NOTE:** The setting for item “RxD, TxD Active”, also called “TX, RX inverting”, allows you to determine the activity of RxD and TxD. We set it to “Hi, Lo”. If your motherboard BIOS uses “No” and “Yes” to represent this item, you should set it to the same setting as the NF7/NF7-M/NF7-S. This means that you should set it to “No, Yes” in order to match the transfer and receiving speed. If you fail to do so, you will not get an IR connection between the NF7/NF7-M/NF7-S and the other computer.

### Onboard Parallel Port:

Sets the I/O address and IRQ of the onboard parallel port. Four options are available: Disabled → 378/IRQ7 → 278/IRQ5 → 3BC/IRQ7. Default setting is **378/IRQ7**.

※ **Parallel Port Mode:**

Four options are available: SPP → EPP → ECP → ECP+EPP. The default setting is **ECP+EPP** mode.

※ **EPP Mode Select:**

Two options are available: EPP1.7 → EPP1.9. The default setting is **EPP 1.9**. When the mode selected for the parallel port mode is EPP, the two EPP version options are available.

※ **ECP Mode Use DMA:**

Two options are available: 1 → 3. The default setting is **3**. When the mode selected for the parallel port mode is ECP, the DMA channel selected can be Channel 1 or Channel 3.

### ↳ For NF7-S2/NF7-S2G:



### IDE Function Setup:

Click <Enter> key to enter its submenu:

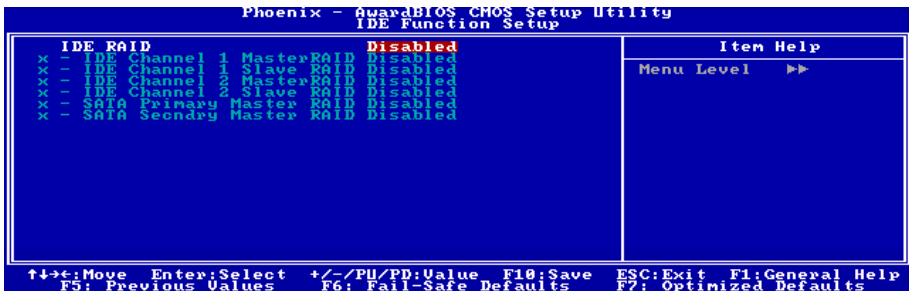

### IDE RAID:

This item allows you to enable or disable the IDE RAID function.

※ **IDE Channel 1/2 Master/Slave RAID, SATA Primary/Secondary Master RAID:**

Select the disks that you want to use as RAID disks.

## ↩ Back to Integrated Peripherals Setup Menu:

### Onboard Device:

Click <Enter> key to enter its submenu:

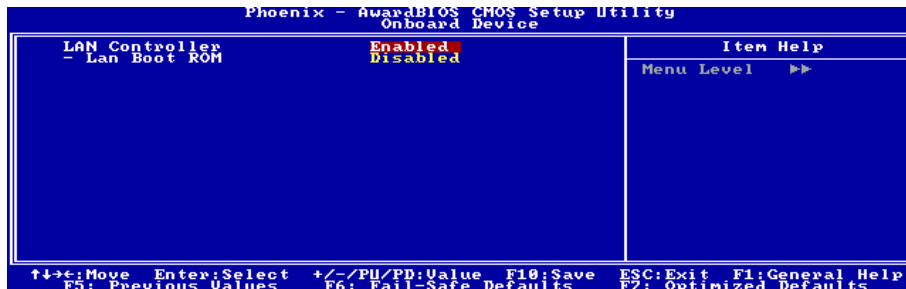

### LAN Controller:

This option enables or disables the LAN controller.

#### \* LAN Boot ROM:

This item allows you to use the boot ROM (instead of a disk drive) to boot-up the system and access the local area network directly.

## ↩ Back to Integrated Peripherals Setup Menu:

### Onchip IDE Device:

Click <Enter> key to enter its submenu:



### OnChip IDE-1/IDE-2 Controller:

This item allows you to enable or disable the primary and secondary IDE controller. Select [Disabled] if you want to add a different hard drive controller.

**IDE Prefetch Mode:**

Two options are available: Disabled or Enabled. The default setting is *Enabled*. The onboard IDE drive interfaces supports IDE prefetching for faster drive accesses. If you install a primary and/or secondary add-in IDE interface, set this field to *Disabled* if the interface does not support prefetching.

**IDE Bus Master:**

This option enables or disables the IDE bus mastering capability under the DOS environment.

↩ **Back to Integrated Peripherals Setup Menu:**

**OnChip PCI Device:**

Click <Enter> key to enter its submenu:

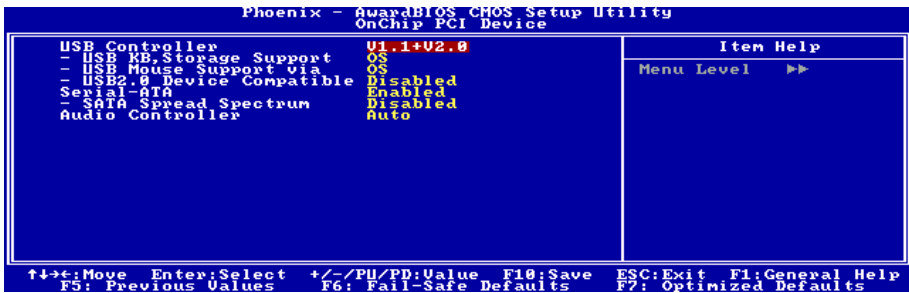
**USB Controller:**

Three options are available: Disabled → V1.1+V2.0 → V1.1. The default setting is *V1.1+V2.0*. If you choose to disable this item, the “**USB Keyboard Support**” and “**USB Mouse Support**” items will not be able to select in *Integrated Peripherals* menu.

\* **USB KB. Storage Support:**

This item allows you to select [**BIOS**] for using USB keyboard or USB storage device in DOS environment, or [**OS**] in OS environment.

\* **USB Mouse Support via:**

This item allows you to select [**BIOS**] for using USB mouse in DOS environment, or [**OS**] in OS environment.

\* **USB2.0 Device Compatible:**

This item enables or disables the compatibility with USB2.0 devices.

**Serial-ATA:**

This option enables or disables the OnChip SATA controller.



### \* SATA Spread Spectrum:

Two options are available: Enabled and Disabled. The default setting is *Disabled*. You can enable or disable the SATA spread spectrum.

### Audio Controller:

This option enables or disables the audio controller.

## ↩ Back to Integrated Peripherals Setup Menu:

### SuperIO Device:

Click <Enter> key to enter its submenu:

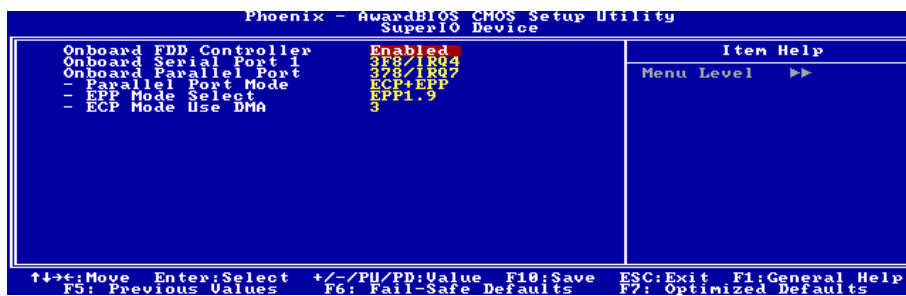

### Onboard FDD Controller:

Two options are available: Enabled and Disabled. The default setting is *Enabled*. You can enable or disable the onboard FDD controller.

### Onboard Serial Port 1:

This is used to specify the I/O address and IRQ of Serial Port 1. Six options are available: Disabled → 3F8/IRQ4 → 2F8/IRQ3 → 3E8/IRQ4 → 2E8/IRQ3 → AUTO. The default setting is *3F8/IRQ4*.

### Onboard Parallel Port:

Sets the I/O address and IRQ of the onboard parallel port. Four options are available: Disabled → 378/IRQ7 → 278/IRQ5 → 3BC/IRQ7. Default setting is *378/IRQ7*.

### \* Parallel Port Mode:

Four options are available: SPP → EPP → ECP → ECP+EPP. The default setting is *ECP+EPP* mode.

### \* EPP Mode Select:

Two options are available: EPP1.7 → EPP1.9. The default setting is *EPP 1.9*. When the mode selected for the parallel port mode is EPP, the two EPP version options are available.

### \* ECP Mode Use DMA:

Two options are available: 1 → 3. The default setting is *3*. When the mode selected for the parallel port mode is ECP, the DMA channel selected can be Channel 1 or Channel 3.

## **Back to Integrated Peripherals Setup Menu:**

---

### **Init Display First:**

This item selects to initialize AGP or PCI Slot first when the system boots.

**[PCI Slot]:** When the system boots, it will first initialize PCI.

**[AGP]:** When the system boots, it will first initialize AGP.

## 3-6. Power Management Setup



### ACPI Suspend Type:

This item selects the type of Suspend mode.

[S1(PowerOn-Suspend)]: Enables the Power On Suspend function.

[S3(Suspend-To-RAM)]: Enables the Suspend to RAM function.

### Power Button Function:

Two options are available: Delay 4 Sec or Instant-Off. The default setting is *Instant-Off*. It is activated when the user presses the power button for more than four seconds while the system is in the working state, then the system will transition to the soft-off (Power off by software). This is called the power button over-ride.

### Wakeup by PME# of PCI:

Two options are available: Disabled or Enabled. The default setting is *Disabled*. When set to *Enabled*, any event affecting from PCI card (PME) will awaken a system that has powered down.

### Wakeup by Ring:

Two options are available: Disabled or Enabled. The default setting is *Disabled*. When set to *Enabled*, any event affecting from Modem Ring will awaken a system that has powered down.

### Wakeup by Alarm: (NF7/NF7-S/NF7-M)

Two options are available: Disabled or Enabled. The default setting is *Disabled*. When set to *Enabled*, you can set the date and time at which the RTC (real-time clock) alarm awakens the system from Suspend mode.

#### \* Time (hh:mm:ss) of Alarm:

You can set the Date (month) Alarm and Time Alarm (hh:mm:ss). Any event occurring will awaken a system that has powered down.

**USB Resume from S3/S4: (NF7-S2/NF7-S2G)**

When set to [Enabled], this item allows you to use a USB device to wake up a system that is in the S3/S4 state.

**Power-On by Alarm: (NF7-S2/NF7-S2G)**

Two options are available: Disabled or Enabled. The default setting is *Disabled*. When set to *Enabled*, you can set the date and time at which the RTC (real-time clock) alarm awakens the system from Suspend mode.

\* **Day of Month Alarm/ Time (hh:mm:ss) Alarm:**

You can set the Date (month) Alarm and Time Alarm (hh:mm:ss). Any event occurring will awaken a system that has powered down.

**Power On Function:**

This item selects the way you want your system to power on.

**[Password]:** Use a password to power on the system, select this option then press <Enter>. Enter your password. You can enter up to 5 characters. Type in exactly the same password to confirm, and then press <Enter>.

**[Hot KEY]:** Use any of the function keys between <F1> to <F12> to power on the system.

**[Mouse Left]:** Double click the mouse left button to power on the system.

**[Mouse Right]:** Double click the mouse right button to power on the system.

**[Any KEY]:** Use any keyboard keys to power on the system.

**[BUTTON ONLY]:** Use only the power button to power on the system.

**[Keyboard 98]:** Use the power-on button on the “Keyboard 98” compatible keyboard to power on the system.

**NOTE:** To enable this “Power On” function, the wake-up header of [KBPWR1] and [USBPWR1], must be set to [Enabled] position. Please refer to the configuration of “Wake-up Header” [KBPWR1] and [USBPWR1] in section 2-4, chapter 2.

The mouse wake up function can only be used with the PS/2 mouse, not with the COM port or USB type. Some PS/2 mice cannot wake up the system because of compatible problems. If the specs of your keyboard are too old, it may fail to power on.

\* **KB Power On Password:**

When you press the <Enter> key, then you can enter the password you want. When set be done, you need to saving and leave the BIOS setting menu to reboot your computer system. **Next time when you shutdown your computer, you can't use the power button to turn on the computer power anymore.** You need to press the password to turn on your computer power.

\* **Hot Key Power On:**

Fifteen options are available: Ctrl+F1 ~ Ctrl+F12, Power, Wake and Any Key. The default setting is *Ctrl+F1*. You can choose the hot key that you want it to turn on your computer power.

**Restore on AC Power Loss:**

This item selects the system action after an AC power failure.

**[Power Off]:** When power returns after an AC power failure, the system's power remains off. You must press the Power button to power-on the system.

**[Power On]:** When power returns after an AC power failure, the system's power will be powered on automatically.

**[Last State]:** When power returns after an AC power failure, the system will return to the state where you left off before power failure occurs. If the system's power is off when AC power failure occurs, it will remain off when power returns. If the system's power is on when AC power failure occurs, the system will power-on when power returns.

### 3-7. PnP/PCI Configurations

☞ **NF7/NF7-S/NF7-M:**



**Force Update ESCD:**

If you want to clear ESCD data next time you boot up, and ask the BIOS to reset the settings for the Plug & Play ISA Card and the PCI Card, select Enabled. But the next time you boot up, this option will automatically be set as Disabled.

**NOTE:** The ESCD (Extended System Configuration Data) contains the IRQ, DMA, I/O port, memory information of the system. This is a specification and a feature specific to the Plug & Play BIOS.

**Resources Controlled By:**

This item configures all of the boot and Plug-and-Play compatible devices.

[Auto(ESCD)]: The system will automatically detect the settings.

[Manual]: Choose the specific IRQ resources in the “IRQ Resources” menu.

\* **IRQ Resources:**

Click <Enter> key to enter its submenu:

This item sets each system interrupt to either [PCI Device] or [Reserved].

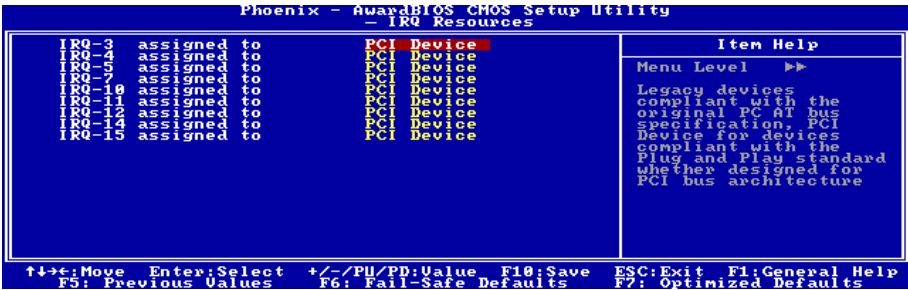

↩ **Back to PnP/PCI Configurations Setup Menu:**

**PCI/VGA Palette Snoop:**

This item determines whether the MPEG ISA/VESA VGA cards can work with PCI/VGA or not.

**[Disabled]:** MPEG ISA/VESA VGA cards do not work with PCI/VGA.

**[Enabled]:** MPEG ISA/VESA VGA cards work with PCI/VGA.

**Allocate IRQ to Video:**

This item assigns an IRQ for the VGA card installed.

**[Enabled]:** Automatically assign an IRQ for the VGA card installed.

**[Disabled]:** The IRQ that was previously occupied by the VGA card will be available for new device.

**Allocate IRQ to USB:**

This item assigns an IRQ for the USB device connected.

**[Enabled]:** Automatically assign an IRQ for the USB device connected.

**[Disabled]:** The IRQ that was previously occupied by the USB device connected will be available for new device.

**PCI Latency Timer:**

The DEC (decimal) numbers from 0 to 255 are available, with the default setting at 32. This item can let you set the PCI latency clock delay time. Which means, you can set how many clocks you want it delay.

**PIRQ 0 Use IRQ No. ~ PIRQ 3 Use IRQ No.:**

This item specifies the IRQ number manually or automatically for the devices installed on PCI slots.

For the relations between the hardware layout of PIRQ (the signals from the south bridge chipset), INT# (means PCI slot IRQ signals) and devices, please refer to the table below:

Signals	PCI-1	PCI-2	PCI-3	PCI-4	PCI-5	SATA
PIRQ_0 Assignment	INT C	INT B	INT A	INT D	INT C	
PIRQ_1 Assignment	INT D	INT C	INT B	INT A	INT D	
PIRQ_2 Assignment	INT A	INT D	INT C	INT B	INT A	INT A
PIRQ_3 Assignment	INT B	INT A	INT D	INT C	INT B	

**NOTE:**

- PCI slot 1 shares IRQ signals with PCI-5, and SATA.
- If you want to install two PCI cards into those PCI slots that share IRQ with one another at the same time, you must make sure that your OS and PCI devices' driver supports the IRQ sharing function.

## ☞ NF7-S2/NF7-S2G:



### Resources Controlled By:

This item configures all of the boot and Plug-and-Play compatible devices.

[Auto(ESCD)]: The system will automatically detect the settings.

[Manual]: Choose the specific IRQ resources in the "IRQ Resources" menu.

#### \* **IRQ Resources:**

Click <Enter> key to enter its submenu:

This item sets each system interrupt to either [PCI Device] or [Reserved].

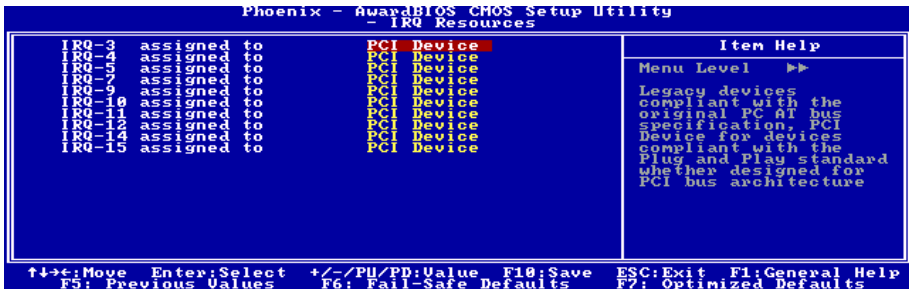

## ☞ Back to PnP/PCI Configurations Setup Menu:

### PCI/VGA Palette Snoop:

This item determines whether the MPEG ISA/VESA VGA cards can work with PCI/VGA or not.

[Disabled]: MPEG ISA/VESA VGA cards do not work with PCI/VGA.

[Enabled]: MPEG ISA/VESA VGA cards work with PCI/VGA.

### Assign IRO for VGA:

This item assigns an IRQ for the VGA card installed.



**[Enabled]:** Automatically assign an IRQ for the VGA card installed.

**[Disabled]:** The IRQ that was previously occupied by the VGA card will be available for new device.

#### **Assign IRQ for USB:**

This item assigns an IRQ for the USB device connected.

**[Enabled]:** Automatically assign an IRQ for the USB device connected.

**[Disabled]:** The IRQ that was previously occupied by the USB device connected will be available for new device.

#### **PCI Latency Timer:**

The DEC (decimal) numbers from 0 to 255 are available, with the default setting at 32. This item can let you set the PCI latency clock delay time. Which means, you can set how many clocks you want it delay.

#### **PIRQ 0 Assignment ~ PIRQ 3 Assignment:**

This item specifies the IRQ number manually or automatically for the devices installed on PCI slots.

For the relations between the hardware layout of PIRQ (the signals from the south bridge chipset), INT# (means PCI slot IRQ signals) and devices, please refer to the table below:

Signals	PCI-1	PCI-2	PCI-3	PCI-4	PCI-5	SATA
PIRQ_0 Assignment	INT C	INT D	INT A	INT B	INT C	
PIRQ_1 Assignment	INT D	INT A	INT B	INT C	INT D	INT A
PIRQ_2 Assignment	INT A	INT B	INT C	INT D	INT A	
PIRQ_3 Assignment	INT B	INT C	INT D	INT A	INT B	

#### **NOTE:**

- PCI slot 1 shares IRQ signals with PCI-5.
- If you want to install two PCI cards into those PCI slots that share IRQ with one another at the same time, you must make sure that your OS and PCI devices' driver supports the IRQ sharing function.

## 3-8. PC Health Status

You can set the warning temperature for your computer system, and you can check the fan speeds and power supply voltages of your computer system. The features are useful for monitoring all the important parameters within your computer system. We call it the *PC Health Status*.

### NF7/NF7-S/NF7-M:



### NF7-S2/NF7-S2G:

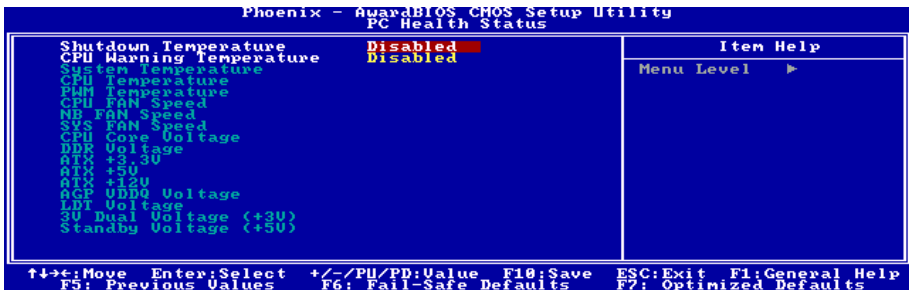

### Shutdown When CPUFAN Fail: (NF7/NF7-S/NF7-M)

Two options are available: Disabled or Enabled. The default setting is *Disabled*. If you set it to *Enabled*, if CPUFAN out of order, system will force to shutdown to protect the processor not overheat.

### CPU Shutdown Temperature / Shutdown Temperature:

Five options are available: Disabled → 60°C/140°F → 65°C/149°F → 70°C/158°F → 75°C/167°F. The default setting is *Disabled*. You can set the processor shutdown temperature here. If the processor temperature exceeds the settings value, system will force to shutdown to protect the processor not overheat.

### CPU Warning Temperature:

This item lets you select the temperature at which you want the system to send out a warning message to the PC speakers of when the temperature goes beyond either limit. You can select the temperatures you want. The ranges are from 50°C to 120°C.

---

### **All Voltages, Fans Speed and Thermal Monitoring:**

These unchangeable items list the current status of the CPU and environment temperatures, fan speeds, and system power voltage.

**NOTE:** The hardware monitoring features for temperatures, fans and voltages will occupy the I/O address from 294H to 297H. If you have a network adapter, sound card or other add-on cards that might use those I/O addresses, please adjust your add-on card I/O address to avoid using these addresses.

---

## **3-9. Load Fail-Safe Defaults**

This option loads the BIOS default values for the most stable, minimal-performance system operations.

---

## **3-10. Load Optimized Defaults**

This option loads the BIOS default values that are factory settings for optimal-performance system operations.

---

## **3-11. Set Password**

This option protects the BIOS configuration or restricts access to the computer itself.

---

## **3-12. Save & Exit Setup**

This option saves your selections and exits the BIOS setup menu.

---

## **3-13. Exit Without Saving**

This option exits the BIOS setup menu without saving any change.



## Appendix A. Install NVIDIA nForce Chipset Driver

**NOTE:** Please install this NVIDIA nForce Chipset driver first after having installed the Windows operating system.

The installation procedures and screen shots in this section are based on Windows XP operating system. For those of other OS, please follow its on-screen instruction.

Insert the Driver & Utility CD into CD-ROM drive, it should execute the installation program automatically. If not, double-click the execution file at the main directory of this CD to enter the installation menu.

After entering the installation menu, move your cursor to [Drivers] tab. Click [nVidia nForce Chipset Driver]. The following screen appears.

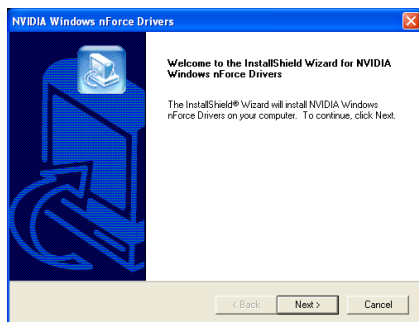

1. Click [Next].

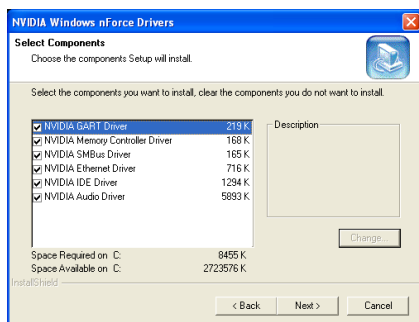

2. Click [Next].

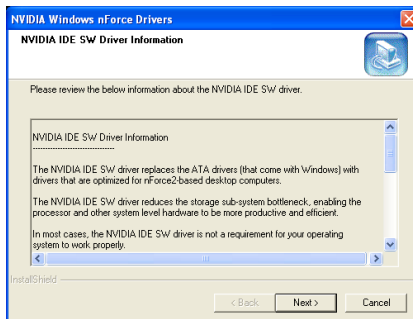

3. Click [Next].

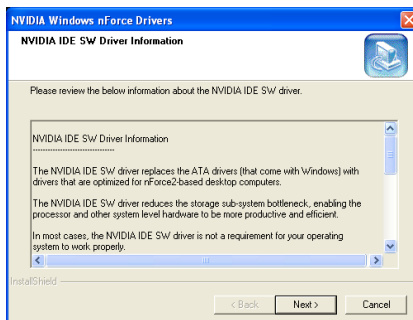

4. Click [Next].

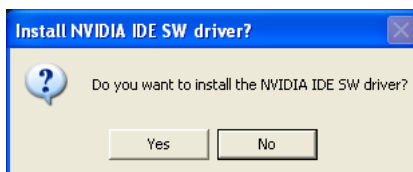

5. Click [Yes].



6. Click [Continue Anyway].



7. Click [Continue Anyway].

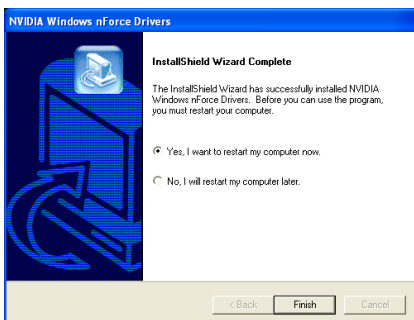

8. Choose [Yes, I want to restart my computer now.], and click [Finish] to complete setup.

## Appendix B. Install Integrated GPU Driver (NF7-M)

The installation procedures and screen shots in this section are based on Windows XP operating system. For those of other OS, please follow its on-screen instruction.

Insert the Driver & Utility CD into CD-ROM drive, it should execute the installation program automatically. If not, double-click the execution file at the main directory of this CD to enter the installation menu.

After entering the installation menu, move your cursor to [Drivers] tab. Click [Integrated GPU Driver]. The following screen appears.

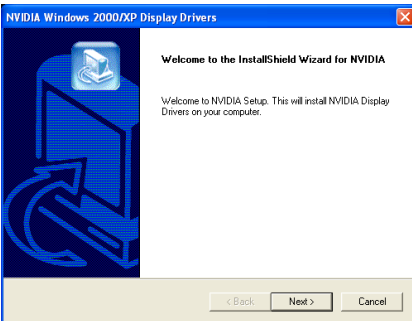

1. Click “Next>”.

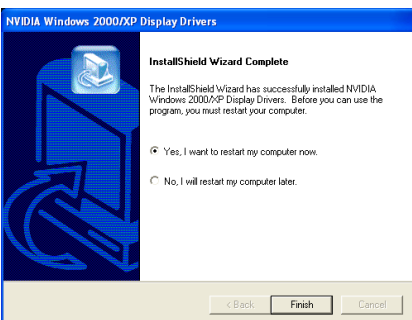

2. Choose [Yes, I want to restart my computer now.], and click [Finish] to complete setup.

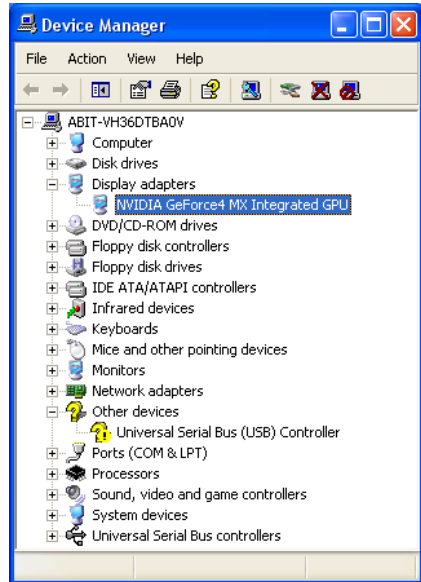

3. When system restarts and enters the operating system, you can then check the “Device Manager” to see that the devices are properly installed.





## Appendix C. Install USB 2.0 Driver

**NOTE:** The “USB 2.0 Driver” packed in the “Driver & Utility CD” is currently available for Windows 9x and ME only. To install this driver for Windows XP or Windows 2000, you have to download their latest service pack first from Microsoft’s web site.

To install the USB 2.0 driver for Windows 9x and ME, please insert the Driver & Utility CD into CD-ROM drive. It should execute the installation program automatically. If not, double-click the execution file at the main directory of this CD to enter the installation menu. The following screen appears.



Click [USB 2.0 Driver], and then follow the on-screen instruction to complete the driver installation.



## Appendix D. Install LAN Driver (NF7-S2G)

To install the LAN driver, please insert the Driver & Utility CD into CD-ROM drive. It should execute the installation program automatically. If not, double-click the execution file at the main directory of this CD to enter the installation menu. The following screen appears.



Click [VIA Ethernet Driver], and then follow the on-screen instruction to complete the driver installation.



## Appendix E. Install Serial ATA Driver (NF7-S)

The installation procedures and screen shots in this section are based on Windows XP operating system. For those of other OS, please follow its on-screen instruction.

Insert the Driver & Utility CD into CD-ROM drive, it should execute the installation program automatically. If not, double-click the execution file at the main directory of this CD to enter the installation menu.

After entering the installation menu, move your cursor to [Drivers] tab. Click [Serial ATA Driver]. The following screen appears.

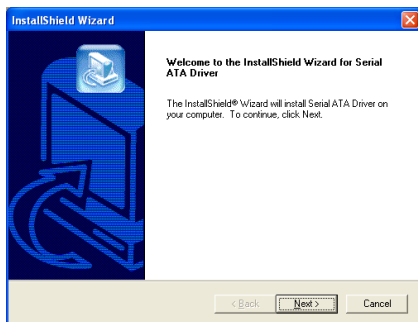

1. Click [Next].



2. Click [Continue Anyway].

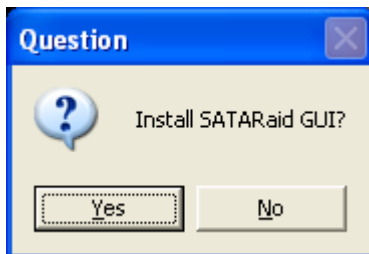

3. Click [Yes].

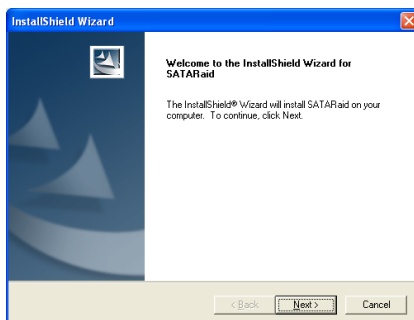

4. Click [Next].

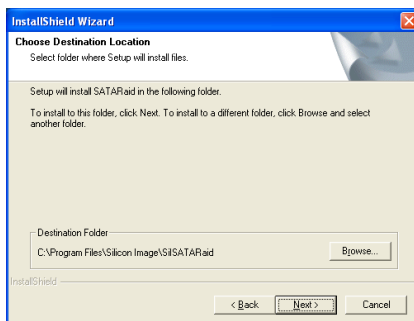

5. Click [Next].

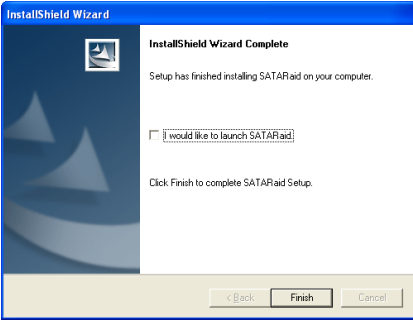

6. Click [Finish].

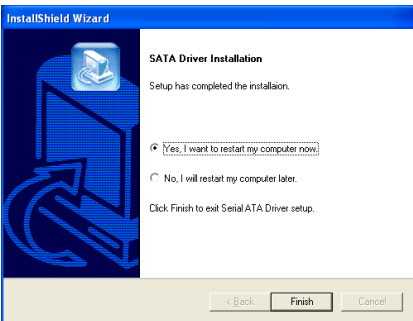

7. Choose [Yes, I want to restart my computer now.], and click [Finish] to complete setup.



8. Check [Device Manager]. [Silicon Image SiI 3112 SATARaid Controller] is successfully installed.

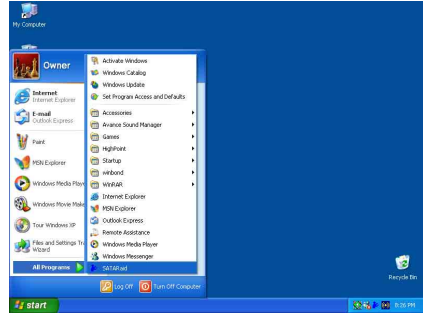

9. To run the [SATARaid] application, click [Start] → [All Programs] → [SATARaid].

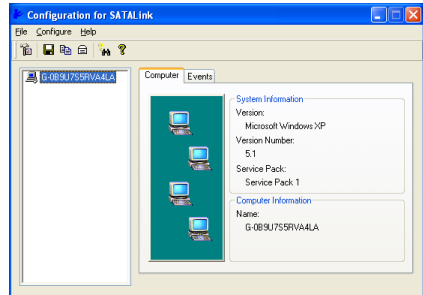

10. This is the SATALink configuration menu. For more information on how to operate, please refer to the “Help” menu.

## BIOS Setup for Serial ATA RAID

NF7-S supports Striped (RAID 0) and Mirrored (RAID 1) RAID set. For the striped RAID set, the identical drives can read and write data in parallel to increase performance. The Mirrored RAID set creates a complete backup of your files. Striped and Mirrored RAID set requires 2 hard disks to do so.

## RAID Configuration Utility Menu

### Main Menu

Reboot your system. Press **<CTRL> + <S>** or **<F4>** key while booting up the system to enter the BIOS setting menu. The main menu of BIOS Setting Utility appears as shown below:

RAID Configuration Utility - Silicon Image Inc. Copyright (C) 2002			
Create RAID set Delete RAID set Rebuild Mirrored set Resolve Conflicts			
* 0	PM	Master 33073H3	29312MB
1	SM	Master 33073H3	29312MB
		TL	Select Menu
		ESC	Previous Menu
		Enter	Select
		Ctrl-E	Exit
		*	First HDD

To select the option in this menu, you may:

- Press **<↑ ↓>** (up, down arrow) to choose the option you want to confirm or to modify.
- Press **<Enter>** to confirm the selection.
- Press **<Esc>** to return to previous menu.
- Press **<Ctrl-E>** to exit the RAID configuration utility.

**NOTE:** If you want to create a RAID 0 (striping) array, all the data stored in the hard disks will first be erased! Please backup the hard disk data before starting to create the RAID array.

If you want to create a RAID 1 (mirroring) array, please make sure which hard disk is the source disk and which one is the destination disk. If you make a mistake, you may copy the blank data to the source disk, which will result in both hard disks becoming blank!

### Option 1 Create RAID set

This item allows you to create a RAID array.

After you had selected the function from the main menu, press the **<Enter>** key to enter the sub menu as shown below:

RAID Configuration Utility - Silicon Image Inc. Copyright (C) 2002			
Create RAID set Delete RAID set Rebuild Mirrored set Resolve Conflicts		Striped Mirrored	
* 0	PM	Master 33073H3	29312MB
1	SM	Master 33073H3	29312MB
		TL	Select Menu
		ESC	Previous Menu
		Enter	Select
		Ctrl-E	Exit
		*	First HDD

#### • Array Mode:

This item allows you to select the appropriate RAID mode for the desired array. There are two modes to choose. When you choose a “Striped” or “Mirrored” RAID set, the utility will ask “Are You Sure?” before the Creating RAID process. Press **<Y>** to confirm.

**NOTE:** It is highly recommended to attach hard disks with the same model in reaching the RAID performance.

**Striping (RAID 0):** This item is recommended for **high performance** usage. Requires at least 2 disks.

**Mirror (RAID 1):** This item is recommended for **data security** usage. Requires at least 2 disks.

**Option 2  
Delete RAID set**

This item allows you to remove a RAID Array on this onboard Serial ATA RAID controller.

**NOTE:** After you have made and confirmed this selection, all the data stored in the hard disk will be lost. (The entire partition configuration will be deleted too.)

**Option 3  
Rebuild Mirrored set**

This item allows you to rebuild only “Mirrored” RAID set.

You need to check which hard disk is the source disk and which one is the destination disk when you decide to rebuild mirrored RAID set.

**Option 4  
Resolve Conflicts**

When a RAID set is created, the metadata written to the disk includes drive connection information (Primary Channel, Secondary Channel).

If, after a disk failure, the replacement disk was previously part of a RAID set (or used in another system), it may have conflicting metadata, specifically in reference to the drive connection information. If so, this will prohibit the RAID set from being either created or rebuilt.

In order for the RAID set to function properly, this old metadata must be first overwritten with the new metadata. To resolve this, select “Resolve Conflict”. The correct metadata, including the correct drive connection information, will then be written to the replacement disk.

**NOTE:** For more information on RAID function, please refer to the RAID Management Software enclosed in the CD that came packed with this motherboard.



# Appendix F. BIOS Setup for NVRAID (NF7-S2/NF7-S2G)

The NF7-S2/NF7-S2G supports the RAID operation of “**Striping (RAID 0)**”, “**Mirroring (RAID 1)**”, “**Striping/Mirroring (RAID 0+1)**”, or “**JBOD/Spanning**”. For the striping operation, the identical drives can read and write data in parallel to increase system performance. The Mirroring operation creates a complete backup of your files. Striping with Mirroring operation offers both read/write performance and fault tolerance. JBOD (Spanning) operation provides the ability to combine drives of different sizes into one large disk.

## Setting Up the BIOS

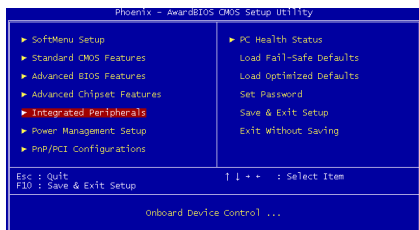

1. Start your computer, then press <Del> key to enter BIOS Setup main menu. Use the arrow key to select **Integrated Peripherals**, then press <Enter> key.

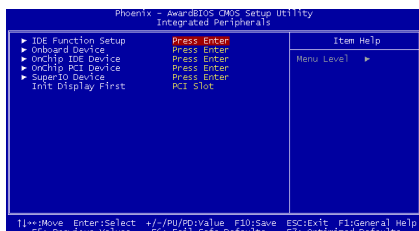

2. The **Integrated Peripherals** setup menu appears as shown above. Use the arrow key to select the **IDE Function Setup**, then press <Enter> key.

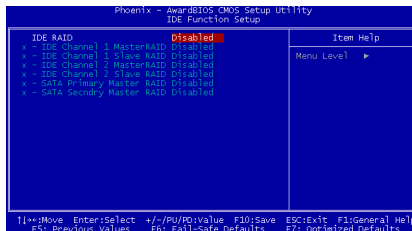

3. The **IDE Function Setup** menu appears. Enable **IDE RAID** item, then enable the disks that you want to use as RAID disks.

4. Press <F10> key to save the configuration and exit the BIOS Setup menu.

## NVIDIA RAID Utility Menu

### Define a New Array

After rebooting your system, wait until you see the RAID software prompting you to press <F10> key.

The RAID prompt appears as part of the system POST and boot process prior to loading the OS. You have a few seconds to press <F10> key before the window disappears.

Press <F10> key, the **Define a New Array** window of NVIDIA RAID Utility appears as shown below.

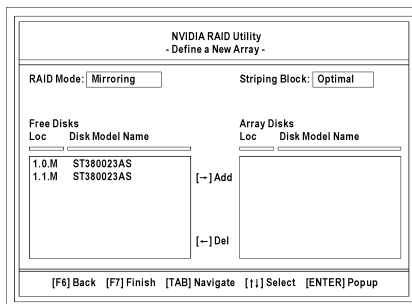

If necessary, press the <Tab> key to move from field to field until the appropriate field is highlighted.

**Selecting the RAID Mode**

By default, RAID Mode is set to *Mirroring*. To change to a different RAID mode, press the down arrow key (<↓>) until the mode that you want appears in the RAID Mode box – either Mirroring, Striping, Spanning, or Striping/Mirroring.

**Selecting the Striping Block Size**

Striping block size affects how data is arranged on the disk. It is recommended to leave this value at the default *Optimal*, which is 32KB, but the values can be between 4KB and 128KB.

**Assigning the Disks**

The disks that you enabled from the **IDE Function Setup** BIOS menu appear in the **Free Disks** block. These are the drives that are available for use as RAID array disks.

To designate a free disk to be used as a RAID array disk:

1. Tab to the **Free Disks** section. The first disk in the list is selected.
2. Move it from the **Free Disks** block to the **Array Disks** by pressing the right arrow key (<→>).

The first disk in the list is moved, and the next disk in the list is selected and ready to be moved.

3. Continue pressing the right arrow key (<→>) until all the disks that you want to use as RAID array disks appear in the Array Disks block.

The figure shown below illustrates the **Define a New Array** window after two disks have been assigned as RAID1 array disks.

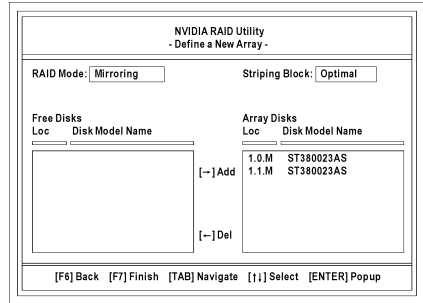

**Completing the RAID BIOS Setup**

After assigning your RAID array disks, press <F7> key. The **Clear disk data** prompt appears.

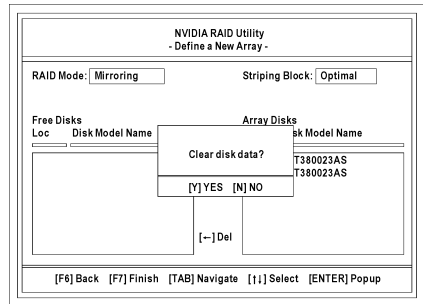

Press <Y> key if you want to wipe out all the data from the RAID array, otherwise press <N> key. You must choose **YES** if the drives were previously used as RAID drives.

**NOTE:** If you want to create a RAID 0 (striping) array or RAID 0+1 array, all the data stored in the hard disks will first be erased! Please backup the hard disk data before starting to create these RAID arrays.

If you want to create a RAID 1 (mirroring) array, please make sure which hard disk is the source disk and which one is the destination disk. If you make a mistake, you may copy the blank data to the source disk, which will result in both hard disks becoming blank!

### Array List

The **Array List** window appears, where you can review the RAID arrays that you have set up.

NVIDIA RAID Utility - Array List -					
Boot	Id	Status	Vender	Array Model Name	
No	2	Healthy	NVIDIA	MIRROR 74.53G	

[Ctrl-X] Exit [F1] Select [B] Set Boot [N] New Array [ENTER] Detail

Use the arrow keys to select the array that you want to set up, then press <Enter> key.

### Array Detail

The **Array Detail** window shows information about the array that you selected, such as Striping Block used, RAID Mode, Striping Width, Disk Model Name, and disk capacity.

If you want to mark this disk as empty and wipe out all its contents, press <C> key.

At the prompt, press <Y> key to wipe out all the data, otherwise press <N> key.

Press <Enter> key again to go back to the previous window and then press <F10> key to exit the RAID setup.

Array 2 : NVIDIA MIRROR 74.53G - Array Detail -						
RAID Mode: Mirroring			Striping Block: 32K			
Striping Width: 1						
Adapt	Channel	M/S	Index	Disk Model Name	Capacity	
1	0	Master	0	ST380023AS	74.53GB	
1	1	Master	1	ST380023AS	74.53GB	

[R] Rebuild [D] Delete [C] Clear Disk [ENTER] Return

**NOTE:** The information shown in the illustrations would vary according to the platform used.



## Appendix G. ABIT EQ (The Hardware Doctor Utility)

ABIT EQ is a self-diagnostic system for PC based on motherboards designed and manufactured by ABIT Computer Corporation. It will protect PC Hardware by monitoring critical items of Power Supply Voltage, CPU & System Fans Speed, and CPU & System Temperature.

The installation procedures and screen shots in this section are based on Windows XP operating system. For those of other OS, please follow its on-screen instruction.

Insert the Driver & Utility CD into CD-ROM drive, it should execute the installation program automatically. If not, double-click the execution file at the main directory of this CD to enter the installation menu.

After entering the installation menu, move your cursor to [ABIT Utility] tab. Click [ABIT EQ]. The following screen appears.

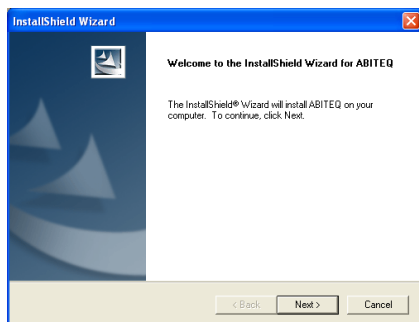

1. Click [Next].

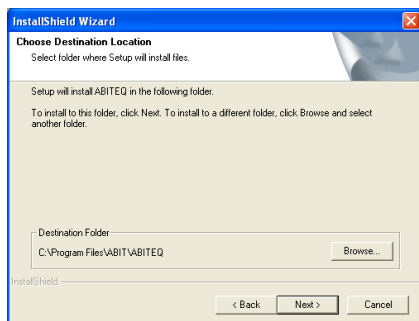

2. Click [Next].

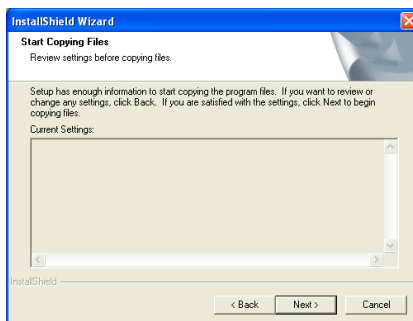

3. Click [Next].

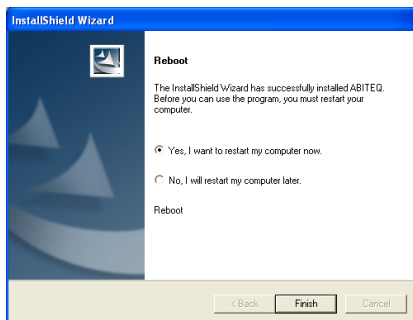

4. Choose [Yes, I want to restart my computer now.] and click [Finish] to complete setup.

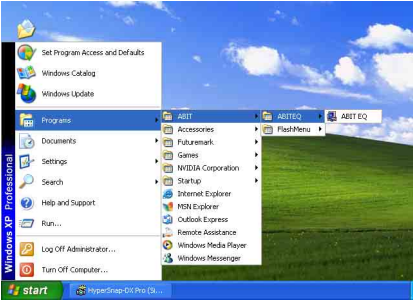

5. Execute the ABIT EQ by entering the Windows Menu [Start] → [All Programs] → [ABIT] → [ABIT EQ].



6. This screen appears. ABIT EQ shows you the status of Voltage, Fan Speed, and Temperature readings as well.

## Appendix H. FlashMenu (BIOS Update Utility)

ABIT FlashMenu is the most stable Windows-based BIOS flash available. No more worries from crashing. With one click of BIOS updating, ABIT users can flash their BIOS more easily and in less time.

The installation procedures and screen shots in this section are based on Windows XP operating system. For those of other OS, please follow its on-screen instruction.

Insert the Driver & Utility CD into CD-ROM drive, it should execute the installation program automatically. If not, double-click the execution file at the main directory of this CD to enter the installation menu.

After entering the installation menu, move your cursor to [ABIT Utility] tab. Click [FlashMenu]. The following screen appears.

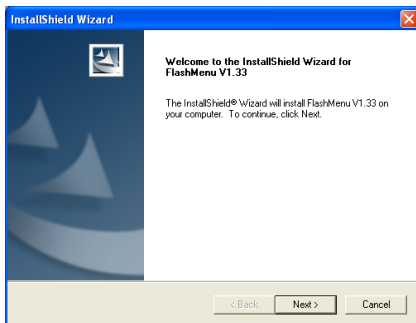

1. Click [Next].

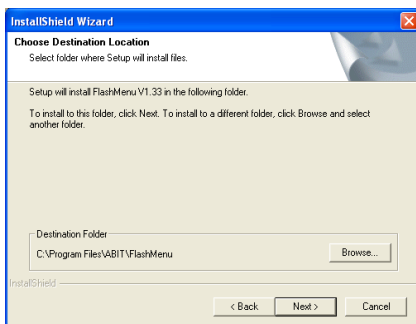

2. Click [Next].

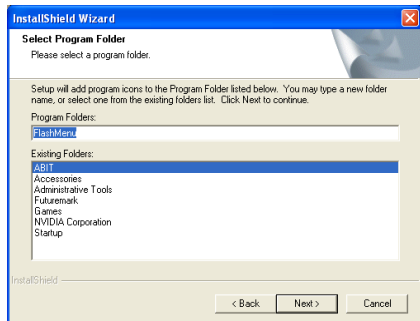

3. Click [Next].

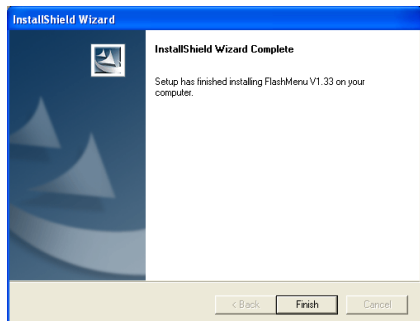

4. Click [Finish] to complete setup.



5. Execute the FlashMenu by entering the Windows Menu [Start] → [All Programs] → [ABIT] → [FlashMenu].



6. This FlashMenu screen appears. You can easily update the BIOS from clicking [Update From File], [One Click LiveUpdate], or [LiveUpdate Step by Step] button.



---

## Appendix I. Troubleshooting (Need Assistance?)

---

### Q & A:

**Q: Do I need to clear the CMOS before I use a new motherboard to assemble my new computer system?**

A: Yes, we highly recommend that you clear the CMOS before installing a new motherboard. Please move the CMOS jumper from its default 1-2 position to 2-3 for a few seconds, and then back. When you boot up your system for the first time, follow the instructions in the user's manual to load the optimized defaults.

**Q: If my systems hang when I update the BIOS or set the wrong CPU parameters, what should I do?**

A: Whenever you update the BIOS or if the system hangs due to wrong CPU parameters setting, always clear CMOS jumper before booting up again.

**Q: Why the system failed to boot up and nothing was displayed on the screen after I did some over-clocking or non-standard settings inside the BIOS? Is the motherboard dead? Do I need to return it to where I bought from or go through an RMA process?**

A: It should not cause hardware or permanent damage to motherboard when BIOS settings were changed from default to over-clocking or non-standard status.

We suggest the following three troubleshooting methods to discharge CMOS data, recover the hardware default status, and then make the motherboard working again. No need to bother returning the motherboard to where you bought from or go through an RMA process.

**Step 1.** Switch off the power supply unit and then switch it on again after one minute. If there is no power switch on the power supply unit, disconnect its power cord for one minute and then connect it back.

Press and hold the <Insert> key on the keyboard, press the power-on button to boot up system. If it works, loose the <Insert> key and hit <Del> key to enter the BIOS setup page to do the correct settings.

If the situation remains the same, repeat the procedures in Step 1 for three times, or try Step 2.

**Step 2.** Switch off the power supply unit or disconnect the power cord. Open the chassis cover. Locate the CCMOS jumper near the button battery. Change the jumper position from default 1-2 to 2-3 for one minute to discharge the CMOS data, and then put it back to default 1-2 position.

Close the chassis and switch on the power supply unit or plug in the power cord. Press the power-on button to boot up system. If it works, hit <Del> key to enter the BIOS setup page to do the correct settings.

If the situation remains the same, try Step 3.

**Step 3.** The same procedure as Step 2, but in the meantime of discharging the CMOS data, pull out ATX power connectors from motherboard and remove the button battery during CMOS discharging.

**Q: How can I get a quick response to my request for technical support?**

A: Be sure to follow the guidelines as stated in the “Technical Support Form” section of this manual.

If you have a problem during operation, in order to help our technical support personnel quickly determine the problem with your motherboard and give you the answers you need, before filling in the technical support form, eliminate any peripheral that is not related to the problem, and indicate it on the form. Fax this form to your dealer or to the company where you bought the hardware in order to benefit from our technical support. (You can refer to the examples given below)

**Example 1:**

With a system including: motherboard (with CPU, DRAM, COAST...) HDD, CD-ROM, FDD, VGA CARD, MPEG CARD, SCSI CARD, SOUND CARD, etc. After the system is assembled, if you cannot boot up, check the key components of the system using the procedure described below. First remove all interface cards except the VGA card and try to reboot.

**If you still cannot boot up:** Try installing another brand/model VGA card and see if the system will start. If it still does not start, note the VGA card model, motherboard model, Bios identification number, CPU on the technical support form (refer to main instructions), and describe the problem in the problem description space provided.

**If you can boot up:** Insert the interface cards you have removed back into the system, one by one and try to start the system each time you insert a card, until the system will not start. Keep the VGA card and the interface card that caused the problem inserted on the motherboard, remove any other cards or peripheral, and start again. If you still cannot start, note the information related to both cards in the add-on Card space provided, and don't forget to indicate the motherboard model, version, BIOS identification number, CPU (refer to main instructions), and give a description of the problem.

**Example 2:**

With a system including the motherboard (with CPU, DRAM, COAST...) HDD, CD-ROM, FDD, VGA CARD, LAN CARD, MPEG CARD, SCSI CARD, SOUND CARD, after assembly and after having installed the Sound Card Driver, when you restart the system, when it runs the Sound Card Driver, it resets automatically. This problem may be due to the Sound Card Driver. During the Starting DOS... procedure, press SHIFT (BY-PASS) key, to skip CONFIG.SYS and AUTOEXEC.BAT; edit CONFIG.SYS with a text editor, and in function the line that loads the Sound Card Driver, add a remark REM, in order to disable the Sound Card Driver. See the example below.

```
CONFIG.SYS:
DEVICE=C:\DOS\HIMEM.SYS
DEVICE=C:\DOS\EMM386.EXE HIGHSCAN
DOS=HIGH, UMB
FILES=40
BUFFERS=36
REM DEVICEHIGH=C:\PLUGPLAY\DWCFMG.SYS
LASTDRIVE=Z
```

Restart the system. If the system starts and does not reset, you can be sure that the problem is due to the Sound Card Driver. Write down the Sound Card model, motherboard model, BIOS identification number on the technical support file (refer to main instructions), and describe the problem in the space provided.

We will show you how to fill the “**Technical Support Form**”.

**Main instructions:**

To fill in this “**Technical Support Form**”, refer to the step-by-step instructions given below:

- 1\*. **MODEL:** Note the model number given in your user’s manual.

Example: NF7/NF7-M/NF7-S/NF7-S2/NF7-S2G

- 2\*. **Motherboard model number (REV):** Note the motherboard model number labeled on the motherboard as “REV:\*.\*\*\*”.

Example: REV: 1.00

- 3\*. **BIOS ID and Part Number:** See the on screen message.

- 4. **DRIVER REV:** Note the driver version number indicated on the DEVICE DRIVER disk (if any) as “Release \*.\*”. For example:

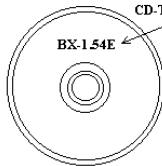

- 5\*. **OS/APPLICATION:** Indicate the operating system and applications you are running on the system.

Example: MS-DOS® 6.22, Windows® 98 SE, Windows® 2000, etc....

- 6\*. **CPU:** Indicate the brand and the speed (MHz) of your CPU.

Example:(A) In the “Brand” space, write “Intel”; in the “Specifications” space, write “Pentium® 4 1.9GHz”.

- 7. **HDD:** Indicate the brand and specifications of your HDD(s); specify if the HDD is using IDE1 or IDE2. If you know the disk capacity, indicate it and check (“✓”) “”; in case you give no indication, we will consider that your HDD is “IDE1” Master.

Example: In the “HDD” space, check the box; in the Brand space, write “Seagate”; in the Specifications space, write “ST31621A (1.6GB)”.

- 8. **CD-ROM Drive:** Indicate the brand and specifications of your CD-ROM drive. Specify if it uses IDE1 or IDE2 , and check (“✓”) “”; in case you give no indication, we will consider that your CD-ROM is “IDE2” Master.

Example: In the “CD-ROM drive” space, check the box, in the Brand space, write “Mitsumi”, in the Specifications space, write “FX-400D”.

- 9. **System Memory (DDR SDRAM):** Indicate the brand and specifications (DDR DIMM) of your system memory. Such as Density, Description, Module Components, Module Part Number, CAS Latency, and Speed (MHz).

For example: In the Brand space, write “**Micron**”; in the Specifications space, write: **Density:** 128MB, **Description:** SS 16 Megx72 2.5V ECC Gold, **Module Components:** (9) 16 Megx 8, **Module Part Number:** MT9VDDT1672AG, **CAS Latency:** 2, **Speed (MHz):** 200 MHz.

Please give us the detailed information of your DDR SDRAM module; it will help us to simulate the problems you met.

- 10. **ADD-ON CARD:** Indicate which add-on cards you are *absolutely sure* are related to the problem.

If you cannot identify the problem’s origin, indicate all the add-on cards inserted into your system.

**NOTE:** Items between the “\*\*” are absolutely necessary.



---

## Appendix J. How to Get Technical Support

---

(From our website) <http://www.abit.com.tw>

(In North America) <http://www.abit-usa.com>

(In Europe) <http://www.abit.nl>

Thank you for choosing ABIT products. ABIT sells all our products through distributors, resellers and system integrators; we have no direct sales to end-users. Before sending email for tech support please check with your resellers or integrators if you need any services, they are the ones who sold you your system and they should know best as to what can be done, how they serve you is a good reference for future purchases.

We appreciate every customer and would like to provide the best service to you. Providing fast service to our customers is our top priority. However we receive many phone calls and a huge amount of email from all over the world. At the present time it is impossible for us to respond to every single inquiry. Therefore it is quite possible that if you send an email to us that you may not receive a response.

We have done many compatibility tests and reliability tests to make sure our products have the best quality and compatibility. In case you need service or technical support, please understand the constraint we have and **always check with the reseller who sold the product to you first.**

To expedite service, we recommend that you follow the procedures outlined below before contacting us. With your help, we can meet our commitment to provide the best service to the **greatest number of ABIT customers:**

- 1. Check the Manual.** It sounds simple but we have taken a lot of care in making a well-written and thorough manual. It is full of information that doesn't only pertain to motherboards. The CD-ROM included with your board will have the manual as well as drivers. If you don't have either one, go to our Program Download Area of the Website or FTP server.
- 2. Download latest BIOS, software or drivers.** Please go to our Program Download area on our Website to check to see if you have the latest BIOS. They are developed over periods of time to fix bugs or incompatibilities. **Also please make sure you have the latest drivers from your peripheral cards makers!**
- 3. Check the ABIT Technical Terms Guide and FAQ on our Website.** We are trying to expand and make the FAQs more helpful and information rich. Let us know if you have any suggestions. For hot topics, check out our HOT FAQ!

4. **Internet Newsgroups.** They are a great source of information and many people there can offer help. ABIT's Internet News group, [alt.comp.periphs.mainboard.abit](mailto:alt.comp.periphs.mainboard.abit), is an ideal forum for the public to exchange information and discuss experiences they have had with ABIT products. Many times you will see that your question has already been asked before. This is a public Internet news group and it is reserved for free discussions. Here is a list of some of the more popular ones:

[alt.comp.periphs.mainboard.abit](mailto:alt.comp.periphs.mainboard.abit)

[comp.sys.ibm.pc.hardware.chips](mailto:comp.sys.ibm.pc.hardware.chips)

[alt.comp.hardware.overclocking](mailto:alt.comp.hardware.overclocking)

[alt.comp.hardware.homebuilt](mailto:alt.comp.hardware.homebuilt)

[alt.comp.hardware.pc-homebuilt](mailto:alt.comp.hardware.pc-homebuilt)

5. **Ask your reseller.** Your ABIT authorized distributor should be able to provide the fastest solution to your technical problem. We sell our products through distributors who sell to resellers and stores. Your reseller should be very familiar with your system configuration and should be able to solve your problem much more efficiently than we could. After all, your reseller regards you as an important customer who may purchase more products and who can urge your friends to buy from him or her as well. They integrated and sold the system to you. They should know best what your system configuration is and your problem. They should have reasonable return or refund policies. How they serve you is also a good reference for your next purchase.
6. **Contacting ABIT.** If you feel that you need to contact ABIT directly you can send email to the ABIT technical support department. First, please contact the support team for the branch office closest to you. They will be more familiar with local conditions and problems and will have better insight as to which resellers offer what products and services. Due to the huge number of emails coming in every day and other reasons, such as the time required for problem reproduction, we will not be able to reply to every email. Please understand that we are selling through distribution channels and don't have the resources to serve every end-user. However, we will try to do our best to help every customer. Please also remember that for many of our technical support team English is a second language, you will have a better chance of getting a helpful answer if your question can be understood in the first place. Be sure to use very, simple, concise language that clearly states the problem, avoid rambling or flowery language and always list your system components. Here is the contact information for our branch offices:

---

**North America and South America** **ABIT Computer (U.S.A.) Corporation**  
45531 Northport Loop West, Fremont CA, 94538, U.S.A.  
Tel: 1-510-623-0500  
Fax: 1-510-623-1092  
Sales: [sales@abit-usa.com](mailto:sales@abit-usa.com)  
Latin America Sales: [ventas@abit-usa.com](mailto:ventas@abit-usa.com)  
Marketing: [marketing@abit-usa.com](mailto:marketing@abit-usa.com)  
Web Site: <http://www.abit-usa.com>

**RMA Center** 46808 Lakeview Blvd. Fremont, CA 94538, U.S.A.

---

**UK and Ireland** **ABIT Computer (U.K.) Corporation Ltd.**  
Unit 3, 24-26 Boulton Road, Stevenage, Herts SG1 4QX, UK  
Tel: 44-1438-228888  
Fax: 44-1438-226333  
E-mail: [sales@abitcomputer.co.uk](mailto:sales@abitcomputer.co.uk)

---

**Germany and Benelux (Belgium, Netherlands, Luxembourg), France, Italy, Spain, Portugal, Greece, Denmark, Norway, Sweden, Finland, and Switzerland** **AMOR Computer B.V. (ABIT's European Office)**  
Jan van Riebeeckweg 15, 5928LG, Venlo, The Netherlands  
Tel: 31-77-3204428  
Fax: 31-77-3204420  
Sales: [sales@abit.nl](mailto:sales@abit.nl)  
Web Site: <http://www.abit.nl>

---

**Austria, Czech, Romania, Bulgaria, Slovakia, Croatia, Bosnia, Serbia, and Macedonia** **Asguard Computer Ges.m.b.H**  
Schmalbachstrasse 5, A-2201 Gerasdorf / Wien, Austria  
Tel: 43-1-7346709  
Fax: 43-1-7346713  
E-mail: [asguard@asguard.at](mailto:asguard@asguard.at)

---

**Shanghai** **ABIT Computer (Shanghai) Co. Ltd.**  
Tel: 86-21-6235-1829  
Fax: 86-21-6235-1832  
Web Site: <http://www.abit.com.cn>

---

**Russia and CIS** **ABIT Computer (Russia) Co. Ltd.**  
Sales: [sales@abit.ru](mailto:sales@abit.ru)  
Info: [info@abit.ru](mailto:info@abit.ru)  
Web Site: <http://www.abit.ru>

---

---

**Poland**     **ABIT Computer (Poland) Co. Ltd.**  
Przedstawicielstwo w Polsce ul. Wita Stwosza 28,  
50-149 Wrocław  
Tel: 48 71 780 78 65 / 66  
Fax: 48 71 372 30 87

---

**Japan**     Web Site: <http://www.abit4u.jp>

---

**Taiwan Head Office**     **ABIT Computer Corporation**  
*(Serving all other territories  
not listed above.  
Taiwan is 8+ GMT time,  
and may have different holiday  
calendar from yours.)*  
No. 323, Yang Guang St., Neihu, Taipei, 114,  
Taiwan  
Tel: 886-2-8751-8888  
Fax: 886-2-8751-3382  
Sales: [sales@abit.com.tw](mailto:sales@abit.com.tw)  
Marketing: [market@abit.com.tw](mailto:market@abit.com.tw)  
Web Site: <http://www.abit.com.tw>

---

7. **RMA Service.** If your system has been working but it just stopped, but you have not installed any new software or hardware recently, it is likely that you have a defective component. Please contact the reseller from whom you bought the product. You should be able to get RMA service there.
  
8. **Reporting Compatibility Problems to ABIT.** Because of tremendous number of email messages we receive every day, we are forced to give greater weight to certain types of messages than to others. For this reason, any compatibility problem that is reported to us, giving detailed system configuration information and error symptoms will receive the highest priority. For the other questions, we regret that we may not be able to reply directly. But your questions may be posted to the Internet news group in order that a larger number of users can have the benefit of the information. Please check the news group from time to time.

**Thank You**

**ABIT Computer Corporation**

**<http://www.abit.com.tw>**



## Free Manuals Download Website

<http://myh66.com>

<http://usermanuals.us>

<http://www.somanuals.com>

<http://www.4manuals.cc>

<http://www.manual-lib.com>

<http://www.404manual.com>

<http://www.luxmanual.com>

<http://aubethermostatmanual.com>

Golf course search by state

<http://golfingnear.com>

Email search by domain

<http://emailbydomain.com>

Auto manuals search

<http://auto.somanuals.com>

TV manuals search

<http://tv.somanuals.com>