

ASUS[®] AP160R-S

Pentium[®] 4 1U Rackmount Server

User Guide



Disclaimer/Copyrights

No part of this manual, including the products and software described in it, may be reproduced, transmitted, transcribed, stored in a retrieval system, or translated into any language in any form or by any means, except documentation kept by the purchaser for backup purposes, without the express written permission of ASUSTeK COMPUTER INC. ("ASUS").

ASUS PROVIDES THIS MANUAL "AS IS" WITHOUT WARRANTY OF ANY KIND, EITHER EXPRESS OR IMPLIED, INCLUDING BUT NOT LIMITED TO THE IMPLIED WARRANTIES OR CONDITIONS OF MERCHANTABILITY OR FITNESS FOR A PARTICULAR PURPOSE. IN NO EVENT SHALL ASUS, ITS DIRECTORS, OFFICERS, EMPLOYEES OR AGENTS BE LIABLE FOR ANY INDIRECT, SPECIAL, INCIDENTAL, OR CONSEQUENTIAL DAMAGES (INCLUDING DAMAGES FOR LOSS OF PROFITS, LOSS OF BUSINESS, LOSS OF USE OR DATA, INTERRUPTION OF BUSINESS AND THE LIKE), EVEN IF ASUS HAS BEEN ADVISED OF THE POSSIBILITY OF SUCH DAMAGES ARISING FROM ANY DEFECT OR ERROR IN THIS MANUAL OR PRODUCT.

Product warranty or service will not be extended if: (1) the product is repaired, modified or altered, unless such repair, modification or alteration is authorized in writing by ASUS; or (2) the serial number of the product is defaced or missing.

Products and corporate names appearing in this manual may or may not be registered trademarks or copyrights of their respective companies, and are used only for identification or explanation and to the owners' benefit, without intent to infringe.

The product name and revision number are both printed on the product itself. Manual revisions are released for each product design represented by the digit before and after the period of the manual revision number. Manual updates are represented by the third digit in the manual revision number.

For previous or updated manuals, BIOS, drivers, or product release information, contact ASUS at <http://www.asus.com.tw> or through any of the means indicated on the following page.

SPECIFICATIONS AND INFORMATION CONTAINED IN THIS MANUAL ARE FURNISHED FOR INFORMATIONAL USE ONLY, AND ARE SUBJECT TO CHANGE AT ANY TIME WITHOUT NOTICE, AND SHOULD NOT BE CONSTRUED AS A COMMITMENT BY ASUS. ASUS ASSUMES NO RESPONSIBILITY OR LIABILITY FOR ANY ERRORS OR INACCURACIES THAT MAY APPEAR IN THIS MANUAL, INCLUDING THE PRODUCTS AND SOFTWARE DESCRIBED IN IT.

Copyright © 2002 ASUSTeK COMPUTER INC. All Rights Reserved.

Product Name:	ASUS AP160R-S
Manual Revision:	1.01 E1068
Release Date:	July 2002

Contents

Disclaimer/Copyrights	2
ASUS Contact Information	5
FCC/CDC Statements	6
Safety Precautions	7
Introduction: About This Manual	9
Audience	10
Contents	10
Conventions	11
References	11
System Package Contents	12
Chapter 1: System Overview	13
1.1 System Features	14
1.2 Front Panel Features	15
1.3 Rear Panel Features	15
1.4 Internal Features	16
Chapter 2: Hardware Setup	17
2.1 Removing and installing the chassis cover	18
Removing the cover	18
Installing the cover	18
2.2 Motherboard Placement	19
Placement Direction	19
Motherboard Screws	19
2.3 Installing a CPU	20
CPU Orientation	20
CPU Socket Location	20
Unlock the CPU Socket	21
Insert the CPU	21
Secure the CPU	21
Install the Heatsink	22
2.4 Installing system memory	23
DIMM sockets location	23
Install a DIMM	23

Contents

2.5	Installing the backplane and bridge boards	24
	Bridge board	24
	Backplane board	25
2.6	Installing a hard disk drive	26
2.7	Installing a PCI card	28
2.8	Installing the front bezel and rack ears	30
2.9	Installing CD-ROM and floppy drives	31
Chapter 3: Hardware Options		33
3.1	Cooling System	34
	Fan locations	34
	Fan connectors	34
	Fan cable connections	35
	Removing the fans	36
3.2	Power connections	37
3.3	Removing the power supply	38
Appendix A: Power Supply		39
A.1	General Description	40
A.2	Specifications	41
	Input Characteristics	41
	Output Characteristics	41
	Over-Voltage Protection (OVP)	41
Appendix B: Troubleshooting		43
B.1	Simple Fixes	44

ASUS Contact Information

ASUSTeK COMPUTER INC. (Asia-Pacific)

Address: 150 Li-Te Road, Peitou, Taipei, Taiwan 112
General Tel: +886-2-2894-3447
General Fax: +886-2-2894-3449
General Email: info@asus.com.tw

Technical Support

MB/Others (Tel): +886-2-2890-7121 (English)
Notebook (Tel): +886-2-2890-7122 (English)
Desktop/Server (Tel): +886-2-2890-7123 (English)
Support Fax: +886-2-2890-7698
Support Email: tsd@asus.com.tw
Web Site: www.asus.com.tw
Newsgroup: cscnews.asus.com.tw

ASUS COMPUTER INTERNATIONAL (America)

Address: 6737 Mowry Avenue, Mowry Business Center,
Building 2, Newark, CA 94560, USA
General Fax: +1-510-608-4555
General Email: tmd1@asus.com

Technical Support

Support Fax: +1-510-608-4555
General Support: +1-502-995-0883
Web Site: www.asus.com
Support Email: tsd@asus.com

ASUS COMPUTER GmbH (Europe)

Address: Harkortstr. 25, 40880 Ratingen, BRD, Germany
General Fax: +49-2102-442066
General Email: sales@asuscom.de (for marketing requests only)

Technical Support

Support Hotline: MB/Others: +49-2102-9599-0
Notebook (Tel): +49-2102-9599-10
Support Fax: +49-2102-9599-11
Support (Email): www.asuscom.de/de/support (for online support)
Web Site: www.asuscom.de

FCC/CDC Statements

Federal Communications Commission Statement

This device complies with FCC Rules Part 15. Operation is subject to the following two conditions:

- This device may not cause harmful interference, and
- This device must accept any interference received including interference that may cause undesired operation.

This equipment has been tested and found to comply with the limits for a Class B digital device, pursuant to Part 15 of the FCC Rules. These limits are designed to provide reasonable protection against harmful interference in a residential installation. This equipment generates, uses and can radiate radio frequency energy and, if not installed and used in accordance with manufacturer's instructions, may cause harmful interference to radio communications. However, there is no guarantee that interference will not occur in a particular installation. If this equipment does cause harmful interference to radio or television reception, which can be determined by turning the equipment off and on, the user is encouraged to try to correct the interference by one or more of the following measures:

- Reorient or relocate the receiving antenna.
- Increase the separation between the equipment and receiver.
- Connect the equipment to an outlet on a circuit different from that to which the receiver is connected.
- Consult the dealer or an experienced radio/TV technician for help.

WARNING! The use of shielded cables for connection of the monitor to the graphics card is required to assure compliance with FCC regulations. Changes or modifications to this unit not expressly approved by the party responsible for compliance could void the user's authority to operate this equipment.

Canadian Department of Communications Statement

This digital apparatus does not exceed the Class B limits for radio noise emissions from digital apparatus set out in the Radio Interference Regulations of the Canadian Department of Communications.

This class B digital apparatus complies with Canadian ICES-003.

Safety Precautions

Electrical Safety



IMPORTANT

- Before installing or removing signal cables, ensure that the power cables for the system unit and all attached devices are unplugged.
- To prevent electrical shock hazard, disconnect the power cable from the electrical outlet before relocating the system.
- When adding or removing any additional devices to or from the system, ensure that the power cables for the devices are unplugged before the signal cables are connected. If possible, disconnect all power cables from the existing system before you add a device.
- If the power supply is broken, do not try to fix it by yourself. Contact a qualified service technician or your dealer.



CAUTION

This product is equipped with a three-wire power cable and plug for the user's safety. Use the power cable with a properly grounded electrical outlet to avoid electrical shock.

Operation Safety



IMPORTANT

- Any mechanical operation on this server must be conducted by certified or experienced engineers.
- Before operating the server, carefully read all the manuals included with the server package.
- Before using the server, make sure all cables are correctly connected and the power cables are not damaged. If any damage is detected, contact your dealer as soon as possible.
- To avoid short circuits, keep paper clips, screws, and staples away from connectors, slots, sockets and circuitry.
- Avoid dust, humidity, and temperature extremes. Place the server on a stable surface.

Introduction

“About This Guide” introduces the contents of this document. This part includes the target audience, chapter description, and conventions used. It also lists other sources of information that are not contained in this manual.

About this guide

Audience

This user guide is intended for system integrators, and experienced users with at least basic knowledge of configuring an entry-level server.

Contents

This guide contains the following parts:

1. Introduction: About this guide

This part introduces the contents of this document. It includes the target audience, chapter description, and conventions used. It also lists other sources of information that are not contained in this manual.

2. Chapter 1: System overview

This chapter describes the general features of the AP160R-S server. It includes sections on front panel and rear panel specifications.

3. Chapter 2: Hardware setup

This chapter lists the hardware setup procedures that you have to perform when installing system components.

4. Chapter 3: Hardware options

This chapter describes the optional hardware procedures that you may have to do when configuring the system.

5. Appendix A: Power supply information

This appendix gives information on the 200-watt switching power supply that came with the AP160R-S server.

6. Appendix B: Troubleshooting

This appendix lists the common problems that you may encounter while using the AP160R-S server. It lists the possible causes of the problems and offers solutions. You may refer to this part and try to solve simple problems before calling customer support.

Conventions

Symbols

To make sure that you perform certain tasks properly, take note of the following symbols used throughout this manual.



WARNING: Information to prevent injury to yourself when trying to complete a task.



CAUTION: Information to prevent damage to the components when trying to complete a task.



IMPORTANT: Information that you **MUST** follow to complete a task.



NOTE: Tips and information to aid in completing a task.

References

Refer to the following sources for additional information and for product and software updates.

1. **ASUS NR-LSR Motherboard User's Manual**

This manual contains detailed information about the NR-LSR motherboard.

2. **ASUS Websites**

The ASUS websites worldwide provide updated information on ASUS hardware and software products. The ASUS websites are listed in the ASUS Contact Information on page 5.

3. **Optional Documentation**

Your product package may include optional documentation such as a CD-ROM manual, warranty flyers, and others that may have been added by your dealer. **NOTE:** These documents are not part of the standard server package.

System Package Contents

The following checklist enumerates the components included in the standard system package.

- 1) ASUS 1U chassis (AR-12)
- 2) ASUS NR-LSR motherboard
- 3) 284W power supply
- 4) Backplane board (BP4LS-AR12)
- 5) PCI riser card (PCI64-3V-AR12)
- 6) Bridge board (BRIDGE-AR12)
- 7) Bridge board for SCSI RAID (BRIDGE/S-AR12)
- 8) 40x40x28 mm system fans (3 units)
- 9) Two fan modules each composed of 4 units of 40x40x28 mm fans
- 10) Front bezel and mounting ears
- 11) ASUS 1U rail kit
- 12) CPU heatsink
- 13) SCSI HDD trays (4 units)
- 14) Support CD that includes drivers, utilities, and ASUS Server Web-based Management (ASWM)
- 15) User guides (for system and motherboard)



NOTE

If any of the above items is missing, contact your dealer.

Chapter 1

This chapter describes the general features of the AP160R-S server. It includes sections on front panel, rear panel, and internal features of the server.

System Overview

1.1 System Features

The ASUS AP160R-S is a stylish barebone server featuring the ASUS NR-LSR motherboard. The server supports the Intel® Pentium® 4 processor in a 478-pin socket, and includes the latest I/O, and video technologies through the chipsets embedded on the motherboard.

Following are highlights of the server's many features.

- **Processor:** Support for Intel® Pentium 4 processor with 400MHz FSB and 512KB L2 cache
- **Memory:** Four DIMM sockets support up to 8GB of system memory using registered ECC PC2100/PC1600 DDR DIMMs
- **System Chipset:** The Serverworks® Grand Champion Low End (GCLE) SystemSet includes the Champion Memory and I/O Controller LE (CMIC-LE) as the host bridge, the Champion South Bridge (CSB5) as a PCI to Low Pin Count (LPC) bridge, and the Champion I/O Bridge (CIOB-X2) that provides a high performance data flow path between the IMB and the I/O subsystem.
- **LAN Chipsets:** The Intel® 82544GC Gigabit Ethernet controller is an integrated Ethernet LAN component that supports 1000Mbps, 100Mbps, and 10Mbps data rates. The Intel 82550 Fast Ethernet controller fully supports 10BASE-T/100BASE-TX networking protocols.
- **SCSI Chipset:** The LSI® 53C1010R SCSI controller supports up to 30 Ultra-160 SCSI devices through the onboard dual-channel SCSI connectors.
- **VGA Chipset:** The ATI® Rage-XL PCI-based VGA controller supports up to 8MB PC-100 display SDRAM for 1280x1024 and true color resolutions.
- **Storage:** Four 1" height, 3.5-inch width HDD drive bays
- **Expansion:** Two full-length 64-bit 133/100MHz PCI-X slots on a proprietary riser card.
- **Power Supply:** 115Vac/230Vac 284-watt auto-switching power supply

1.2 Front Panel Features

The front panel of the server allows easy access to the hard disk drives. The power and reset buttons, LED indicators, and the 68-pin connector for the Combo module are also located on the front panel.

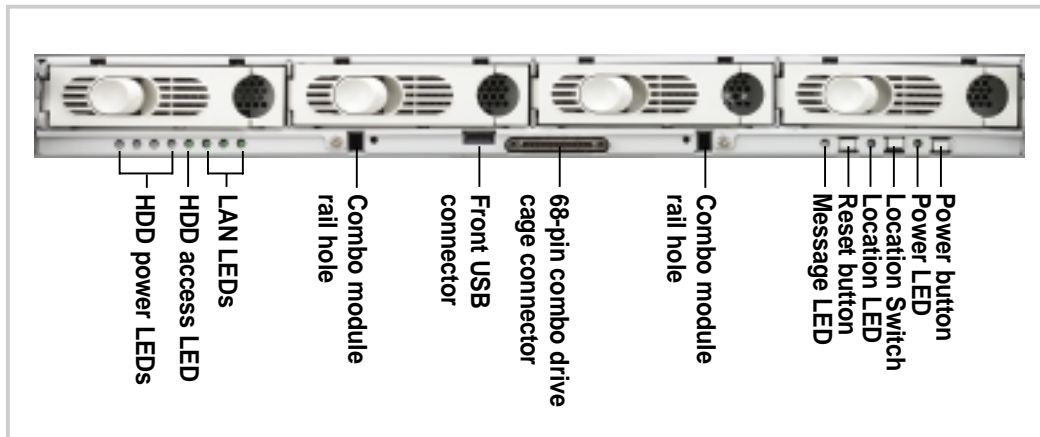

1.3 Rear Panel Features

The server rear panel includes the connectors, the system devices, and two slots for expansion cards.

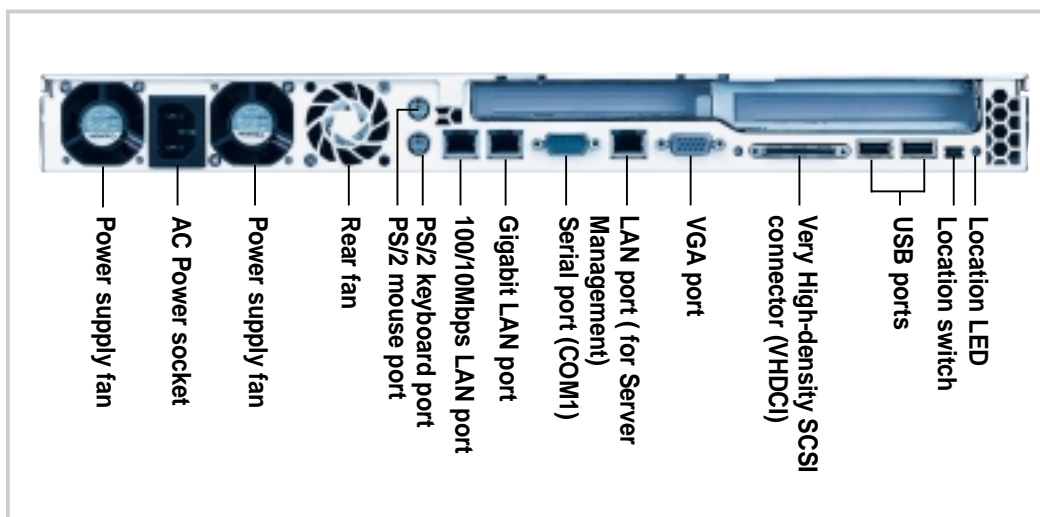

1.4 Internal Features

The standard components inside the AP160R-S server include the motherboard, backplane, bridge board, fans and fan modules, PCI riser card assembly, and power supply. The pictures below show the standard components of the server.

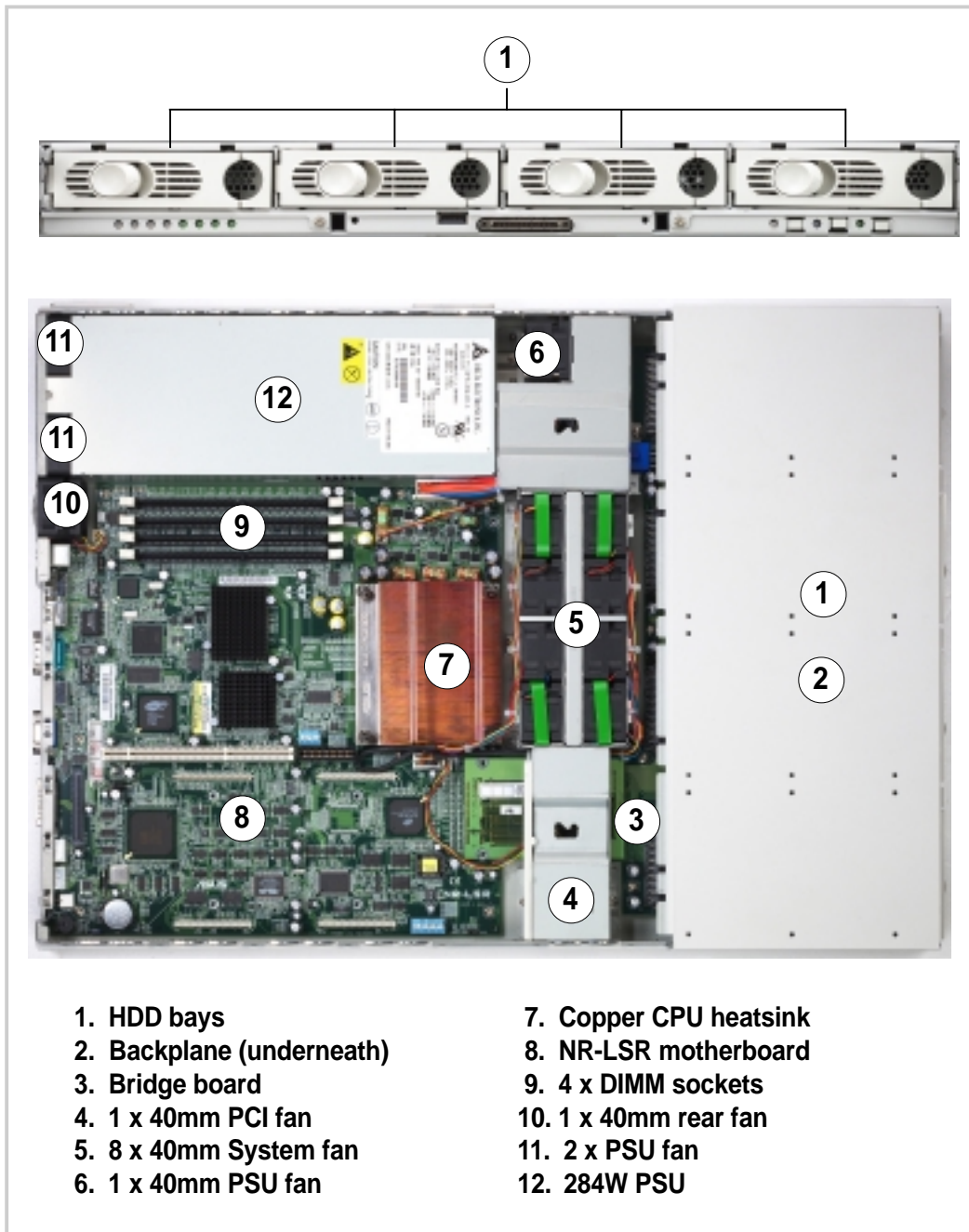

NOTE

The PCI riser card and card bracket assembly is not shown installed in the above picture. Refer to section "2.7 Installing a PCI card" for more details on the riser card.

Chapter 2

This chapter describes the hardware setup procedures that you have to perform when installing system components.

Hardware Setup

2.1 Removing and installing the chassis cover

Removing the cover

1. To release the cover, push the two latches outward, then slide the cover towards the rear for about half an inch.
2. Lift the cover from the chassis.

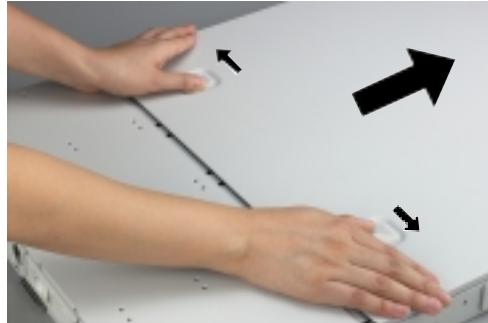

Installing the cover

1. Place the cover on top of the chassis leaving about half an inch gap from the front edge.

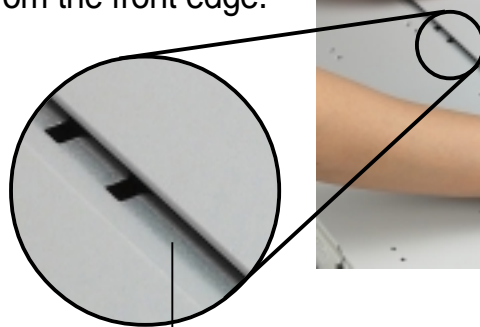

Half-inch gap

2. Firmly hold down the cover and you slide it towards the front until it fits in place.



2.2 Motherboard Placement



NOTE

The motherboard and other internal components of the AP160R-S server are already installed as indicated in section "1.4 Internal Features". Refer to the motherboard user's manual for detailed technical information about the motherboard.

Placement Direction

When installing the motherboard, make sure that you place it into the chassis correctly. The edge with the external ports goes to the rear part of the chassis.

Place this side
towards the rear
of the chassis

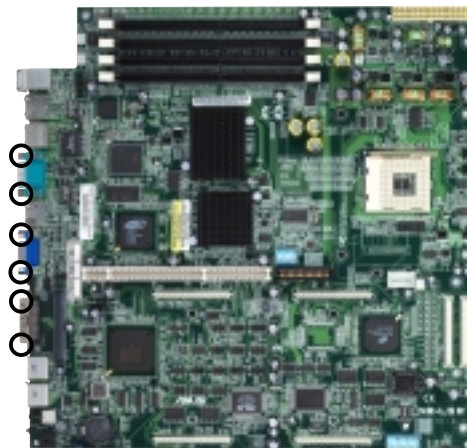

NOTE

You must remove the protruding screws (indicated by black circles above) on the serial port, VGA port, and high-density SCSI connector before installing or removing the motherboard. Otherwise, you cannot properly install or remove the motherboard.

Motherboard Screws

Place seven (7) screws in the holes indicated by circles to secure the motherboard to the chassis. Do not overtighten the screws. Doing so may damage the motherboard.



2.3 Installing a CPU

The 478-pin Zero Insertion Force (ZIF) socket on the NR-LSR motherboard supports an Intel Pentium 4 processor. This section tells you how to install a CPU. Refer to the motherboard user guide for more information.

CPU Socket Location

Locate the 478-pin CPU socket and note the Pin 1 location.

Pin 1

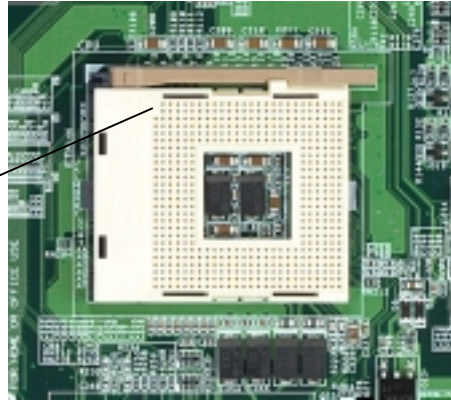

CPU Orientation

A CPU has a mark (usually a notch or a gold mark) on one corner to help you identify the correct orientation when inserting it to the socket.

Match the marked corner of the CPU to Pin 1 on the socket.

Gold Mark

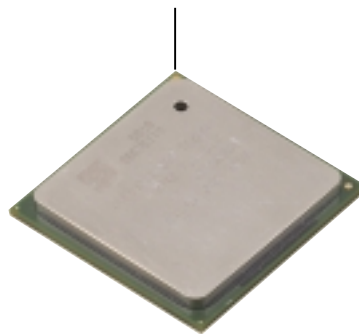

CAUTION

Incorrect installation of the CPU into the socket may bend the pins and severely damage the CPU!

Unlock the CPU Socket

Unlock the socket by pressing the lever sideways then lifting it up to a 90°-100° angle.

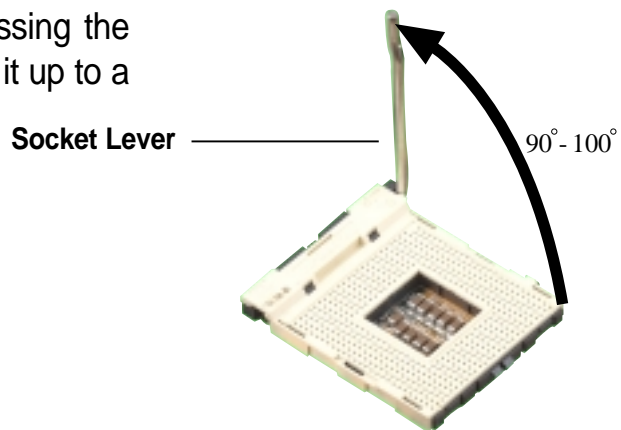

Insert the CPU

1. Position the CPU above the socket such that its marked corner matches the base of the socket lever.
2. Carefully insert the CPU into the socket until it fits in place.

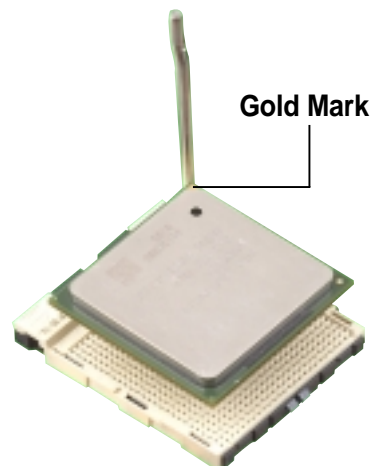

Secure the CPU

When the CPU is in place, press it firmly on the socket while you push down the socket lever to secure the CPU. The lever clicks on the side tab to indicate that it is locked.

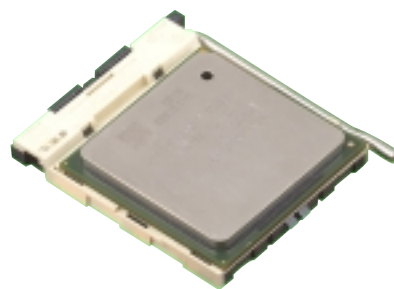



NOTE

You must remove the riser card module and card bracket assembly before installing or removing the heatsink.

Install the Heatsink

1. Carefully place the heatsink on top of the installed CPU. The heatsink fits in only one orientation. Take note of the heatsink placement as shown (ASUS logo facing the rear panel).

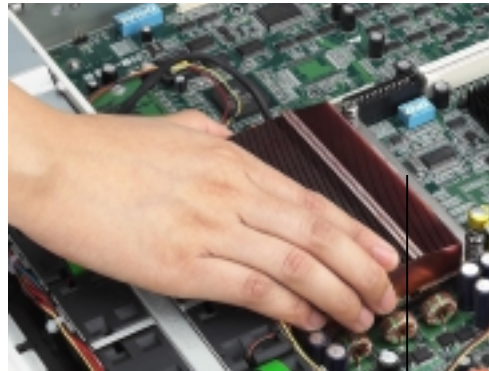

ASUS logo

2. Hold down the heatsink lightly and twist each of the four screws with a Philips (cross) screwdriver just enough to attach the heatsink to the motherboard.
3. When the four screws are attached, tighten them one by one to completely secure the heatsink.

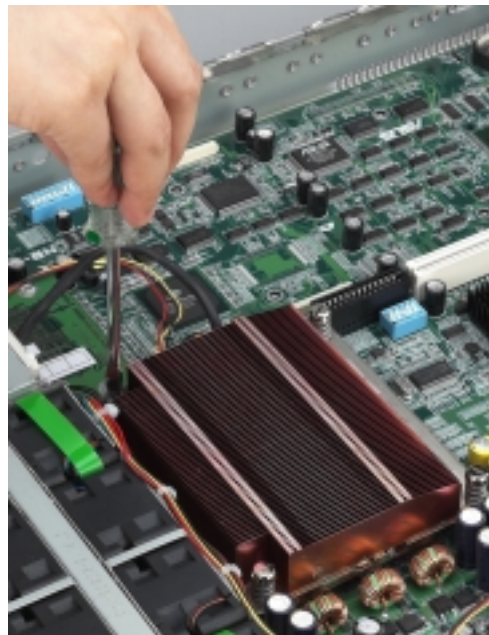

2.4 Installing system memory

DIMM sockets location

The motherboard has four Dual Inline Memory Module (DIMM) sockets that support up to 8GB system memory using registered ECC PC2100/PC1600 DDR DIMMs.

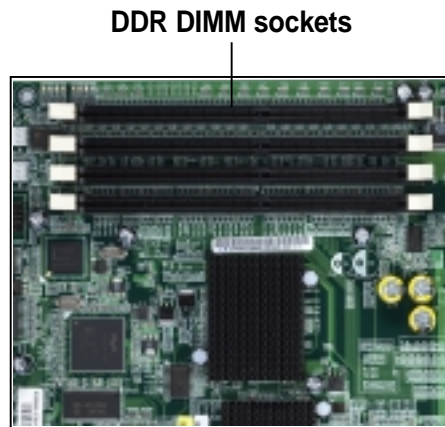

Install a DIMM

1. Unlock a DIMM socket by pressing the retaining clips outward.
2. Align a DIMM on the socket such that the notch on the DIMM matches the break on the socket.
3. Firmly insert the DIMM into the socket until the retaining clips snap back in place and the DIMM is properly seated.

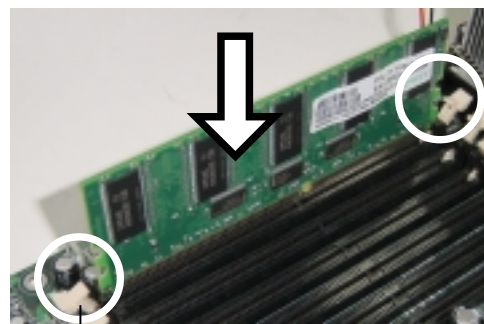

Unlocked Retaining Clip



CAUTION

A DDR DIMM is keyed with a notch so it fits in only one direction. DO NOT force a DIMM into a socket to avoid damaging the DIMM.

Remove a DIMM

1. Simultaneously press the retaining clips outward to unlock the DIMM.
2. Remove the DIMM from the socket.

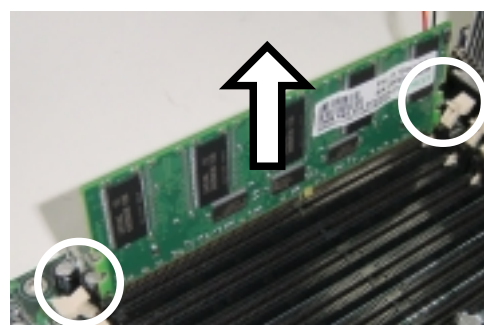

2.5 Installing the backplane and bridge boards

2.5.1 Bridge board (BRIDGE-AR12)

The bridge board links several functions and signals from the motherboard to the backplane board. The board connects to the pair of connectors labeled BPCON on the motherboard and to another pair on the backplane. Four screws secure the bridge board to the motherboard and backplane (indicated by circles in the figure below).

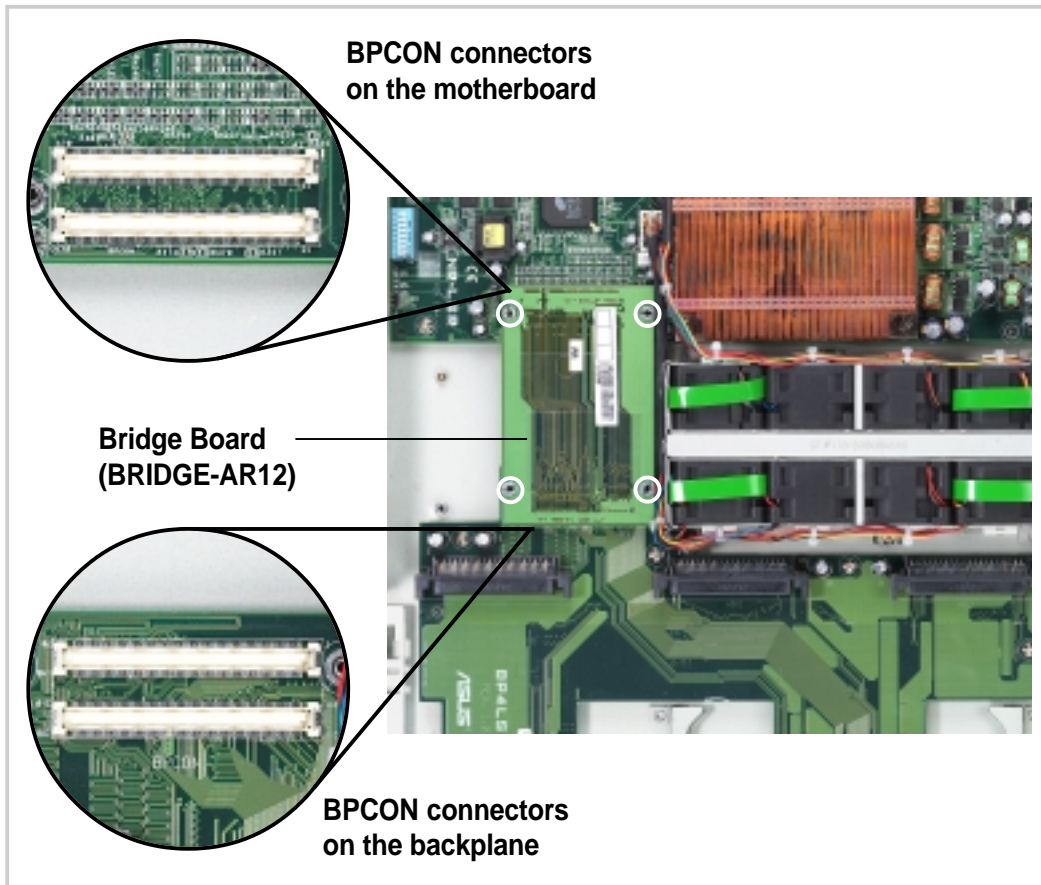

2.5.2 Bridge board (BRIDGE/S-AR12)

If you installed a RAID card, you may create a RAID configuration using the bundled bridge board for SCSI RAID (BRIDGE/S-AR12).

1. Remove the standard bridge board (BRIDGE-AR12) and replace it with the SCSI RAID bridge board (BRIDGE/S-AR12).
2. Install the bridge board with the 68-pin SCSI connector facing the rear panel (see picture on the next page). Take note of the BPCON connectors for the motherboard (MB) and the backplane (BP).
3. Secure the bridge board with four screws.
4. Connect a 68-pin SCSI cable from the RAID card to the SCSI connector on the bridge board.

When installed, the SCSI RAID bridge board appears as shown below.

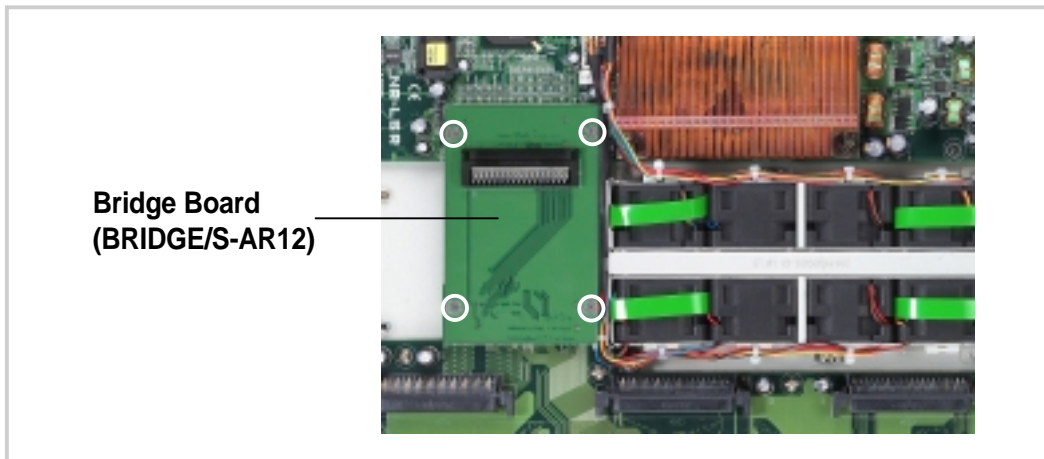

2.5.3 Backplane board

The backplane board includes the four hot-swappable connectors for the SCSI drives accessible from the front panel, and several other connectors that link to the motherboard and main power supply unit.

The backplane board comes pre-installed in the chassis. Normally, you do not need to remove the backplane from the chassis unless it is damaged and needs repair. In case you will have to remove and re-install the backplane, take note of the location of the screws (indicated by circles in the figure below) that secure it to the chassis.

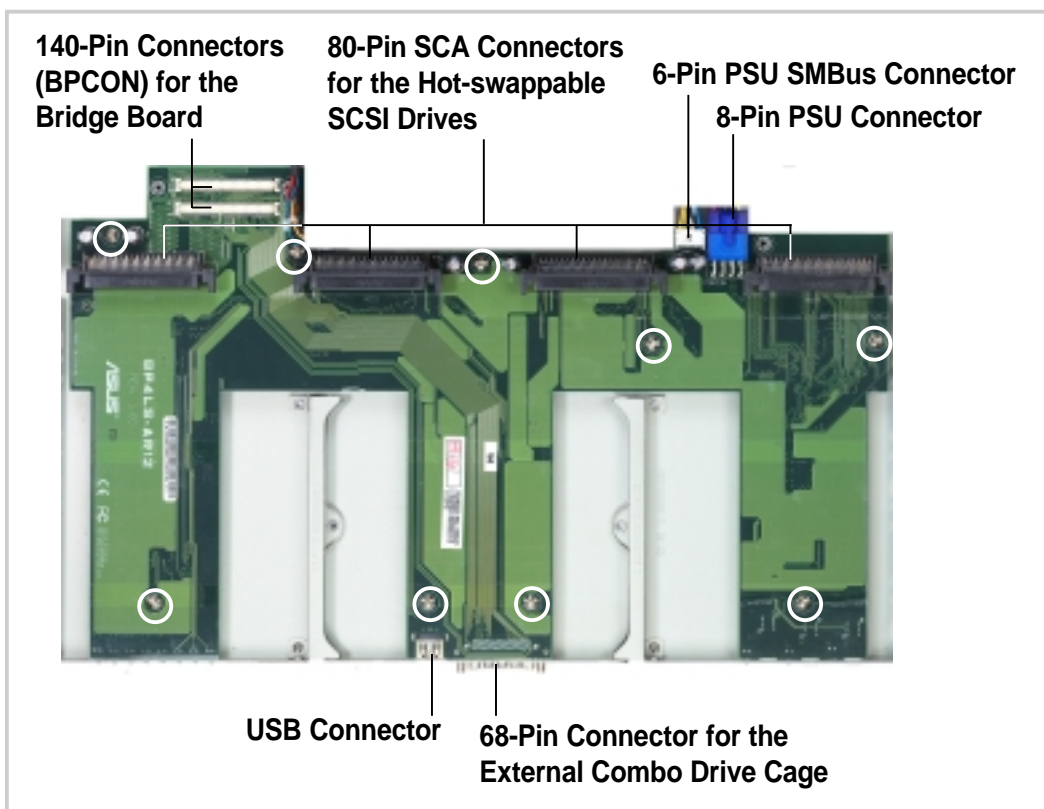

2.6 Installing a hard disk drive

1. Push the thumb pad all the way to the right to release the HDD tray.



2. Pull out the tray handle then pull the tray out of the chassis.

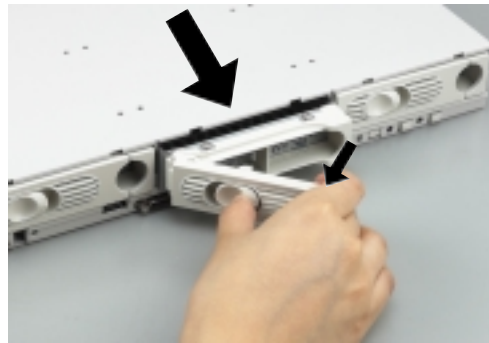

3. Secure a hard disk drive to the tray using four screws.



4. After securing the drive to the tray, carefully insert the tray into the drive bay.



5. Push the tray all the way to the depth of the bay until it fits.

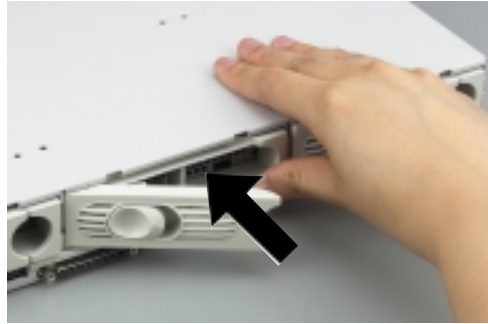

6. Push the tray handle back in place.



CAUTION

Make sure that the HDD tray is completely in place before you push the handle back to avoid damaging the drive and the tray.

2.7 Installing a PCI card

1. The PCI riser card and card bracket assembly comes pre-installed in the chassis. Pull up the metal lever to release and detach the assembly from the chassis.

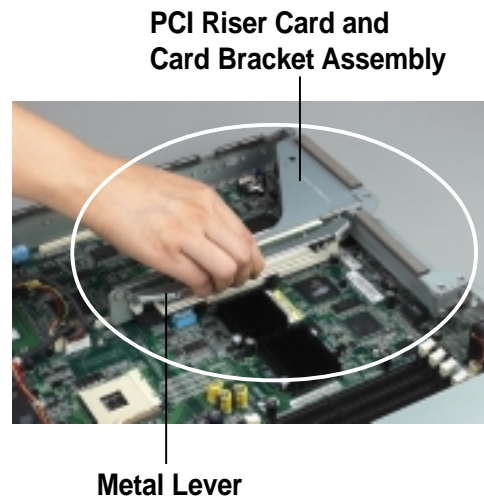

2. Install a PCI or PCI-X card into a riser card slot, and secure the card with a screw. Do the same procedure if you are installing another card into the second slot on the opposite side of the riser card.

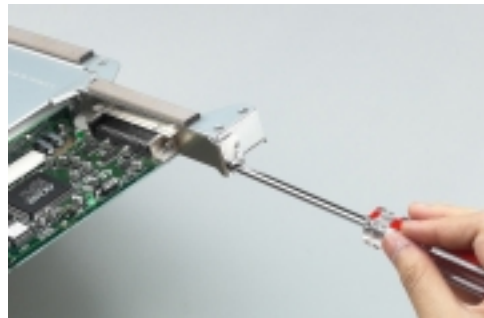

NOTE: If you are installing an extended PCI card, pull up the plastic card holder before installing the assembly back into the chassis.

Extended Card Holder



3. When the cards are installed, replace the riser card assembly into the chassis. Pull up the metal lever and align the riser card golden fingers with the PCI slot. Firmly insert the riser card into the slot.



4. When the riser card assembly is in place, push down the card holder to secure the end of the extended PCI card.

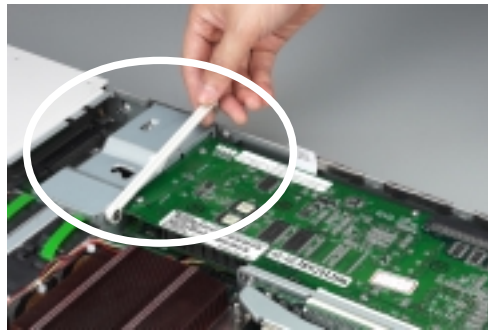

The picture on the the right shows the installed riser card assembly and PCI cards.



2.8 Installing the front bezel and rack ears

1. Secure a metal handle to one end of the front bezel using two small screws that came with the accessory box. Do the same to secure a metal handle to the other end of the bezel.



2. Fit the front bezel to the chassis together with the mounting ear by matching the screw holes. Secure the mounting ear using two screws. Do the same to secure the other mounting ear.

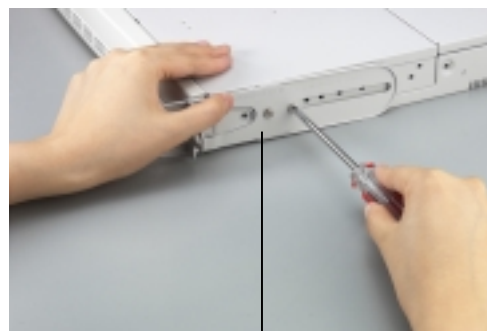

Mounting ear

3. Press the black peg to fasten the front bezel to the mounting ear. Do the same to the other peg.



To remove the front bezel, pull the black pegs on each end to release, then use your two hands to pull out the front bezel as shown.



2.9 Installing CD-ROM and floppy drives

The slim-type CD-ROM drive and slim-type floppy drive are contained in an external combo drive cage. You will need these drives when installing the drivers, utilities, and software applications. The drives are not hot-swappable so you should install them before powering up the system. However, you can detach the cage from the chassis when you do not need it anymore. No need to shut down the system.



NOTE

The combo drive cage and drives are NOT standard shipping items in the AP160R-S system package. These items are sold separately.

1. When shipped, the rails of the combo drive cage are attached to the sides as shown. Remove the screw closer to the front and set it aside.



Remove this screw

2. Loosen the other screw closer to the rear side. Do not remove the screw completely.



Loosen this screw

3. Turn the rail 180 degrees. The screw hole on the rail should align to the hole on the side of the cage.



4. Secure the rail with the screw that you removed earlier. Tighten the other screw.



5. Follow steps 1 to 4 to install the other rail.

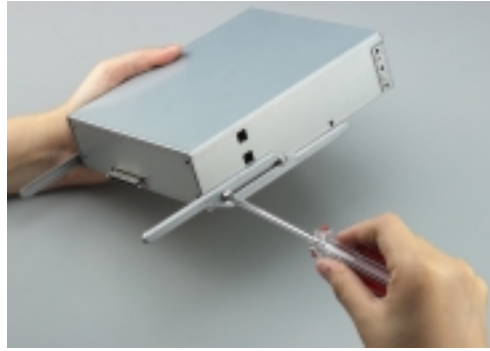

6. Insert the rails to the holes on the front panel and match the 68-pin connector at the rear of the drive cage with the connector on the front panel.

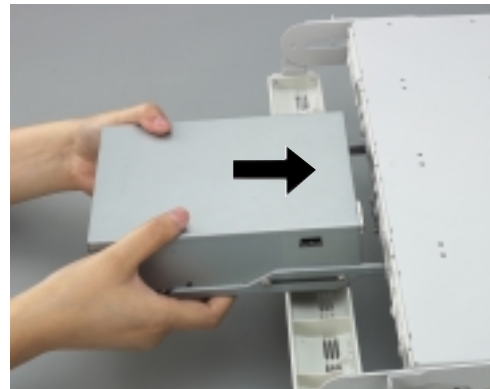

7. Firmly push the combo drive cage into the chassis until it fits in place.

In case you need to replace either the CD-ROM or the floppy drive inside the combo drive cage, follow these steps.

1. Use a Philips (cross) screwdriver to remove the screws that secure the drives to the cage.



2. To remove the CD-ROM drive, insert the end of the screwdriver into the **upper** hole on the side of the cage and lightly push the drive toward the front. The drive slips out for about an inch. Pull the drive out of the cage.



3. To remove the floppy drive, insert the end of the screwdriver into the **lower** hole on the side of the cage and lightly push the drive toward the front. When the drive slips out, pull it out of the cage.

Chapter 3

This chapter describes the optional hardware procedures that you may have to do when configuring the system.

Hardware Options

3.1 Cooling System

There are eleven (11) 40 x 40 x 28mm fans in the chassis to maintain the optimal temperatures of the CPU, PCI cards, and power supply unit.

3.1.1 Fan locations

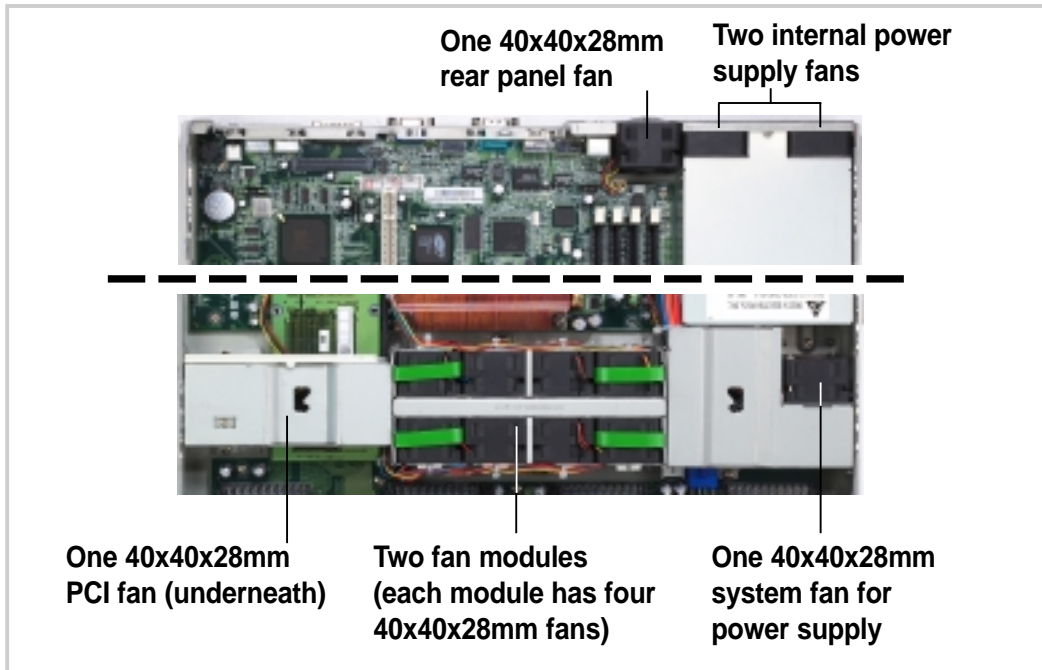

3.1.2 Fan connectors

The following figure shows the fan connector locations on the motherboard. Some of the fan connectors are not accessible unless you remove some system components. Refer to the previous sections for instructions on removing system components.

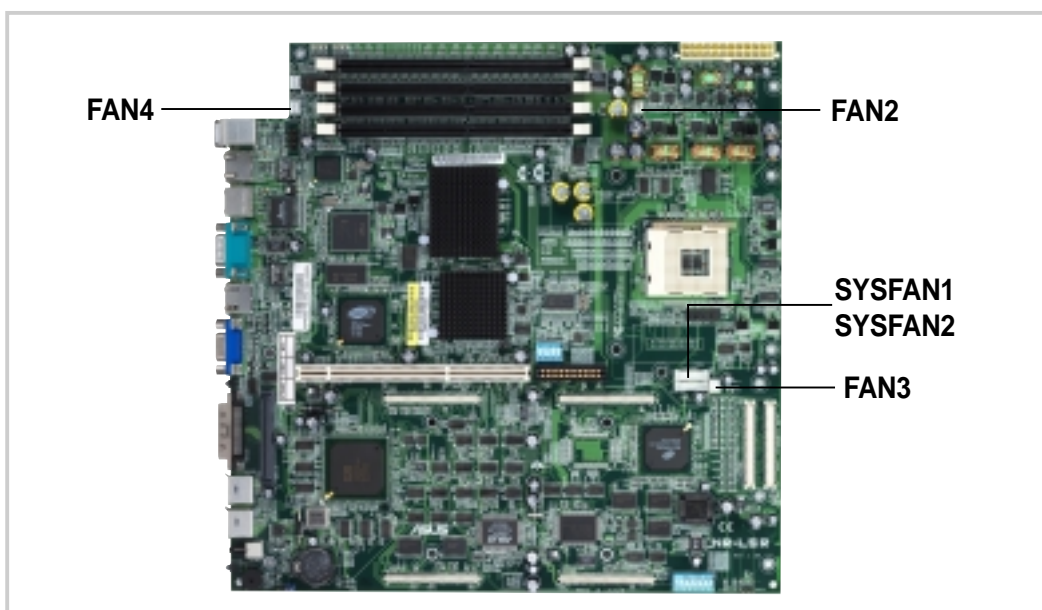

3.1.3 Fan cable connections

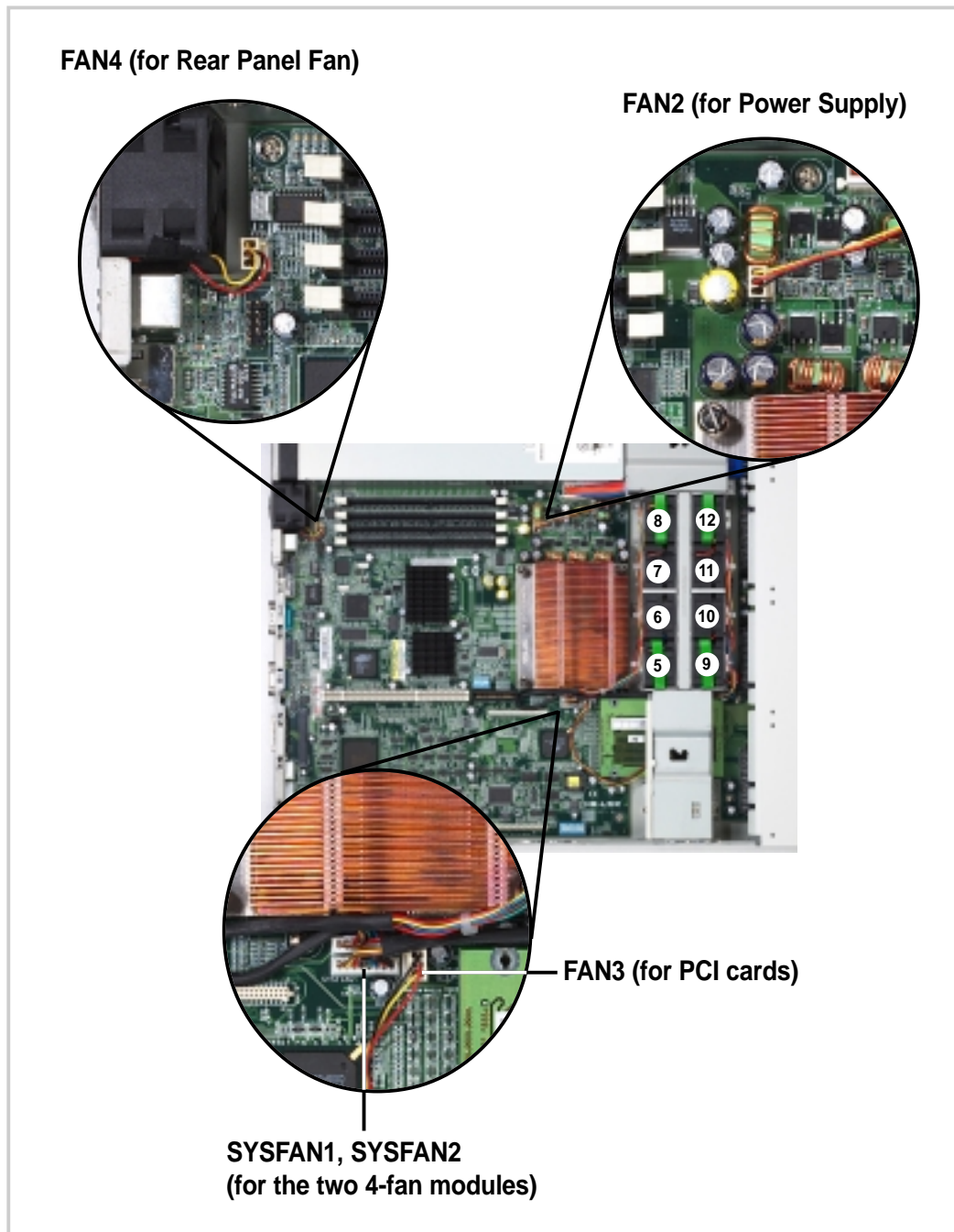

NOTES

The fan module numbered 5-6-7-8 (see location in the above picture) connects to SYSFAN1 connector.

The fan module numbered 9-10-11-12 connects to SYSFAN2 connector.

3.1.4 Removing the fans

Remove the fans only when they get damaged and need to be replaced.

PCI fan

The PCI fan is covered by a metal cage. To remove the fan, remove the two screws that secure the cage on both sides. Lift the metal cage and fan out of the chassis. The PCI fan cable connects to the connector FAN3 on the motherboard.



Power fan

The power supply fan is attached to a metal cage. To remove the fan, remove the two screws that secure the cage as shown. Lift the metal cage and fan out of the chassis. The fan for the power supply is attached to the connector marked FAN2.

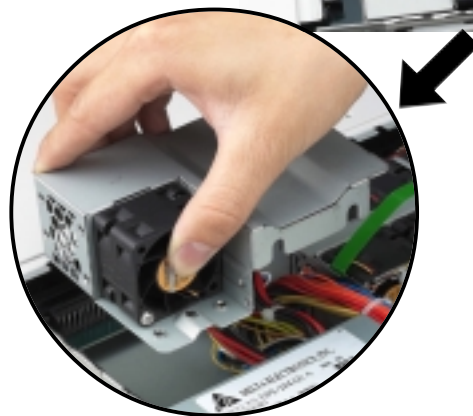
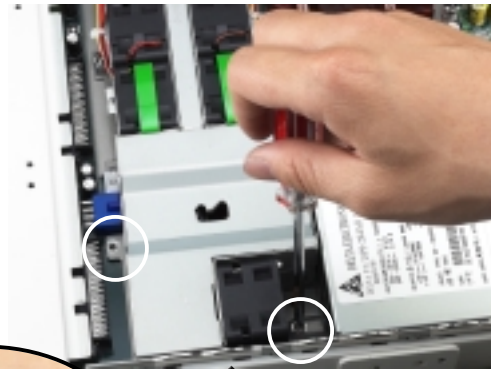

System fan modules

To remove a system fan module, remove the screw that secures the module. Hold the green strap on each end of the module and carefully lift up the module.



3.2 Power connections

The server provides a “cable-less” solution for easy assembly and maintenance. Most of the cables in the server are already connected to their respective connectors. The picture below shows the cables that you need to detach when installing or removing components.

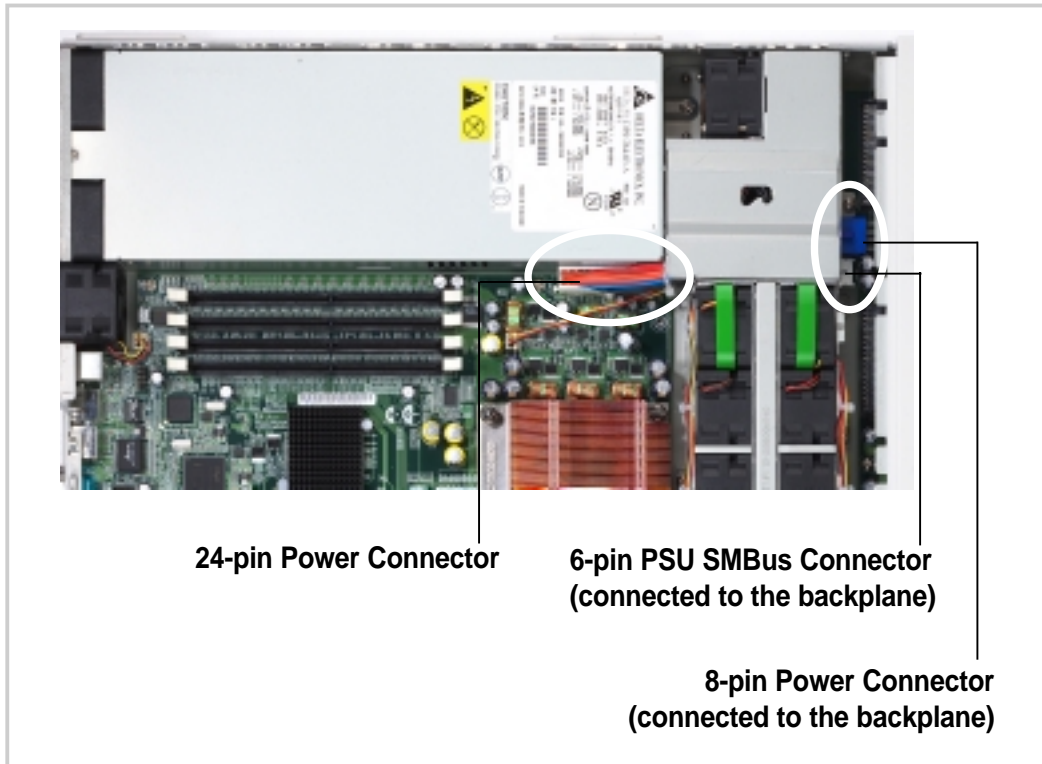

3.3 Removing the power supply

Follow these steps in case you need to remove the power supply in the future.



NOTES

Remove all system components that overlap with the power supply.

Remove all power cable connections.

Refer to the previous sections for instructions on removing system components.

1. Remove the screw that secures the power supply to the chassis base.



2. Remove the screw that secures the power supply to the rear panel.



3. Carefully lift the power supply from the chassis.

Appendix A

This appendix gives information on the 284W switching power supply that comes with the AP160R-S server.

Power Supply

A.1 General Description

The server comes with an SSI-type 284W ATX power supply with universal AC input that includes PFC and ATX-compliant output cables and connectors. The power supply has two internal cooling fans.

The power supply has three plugs labeled P1, P2, and P3. The picture below shows the specific device assignments for the plugs.

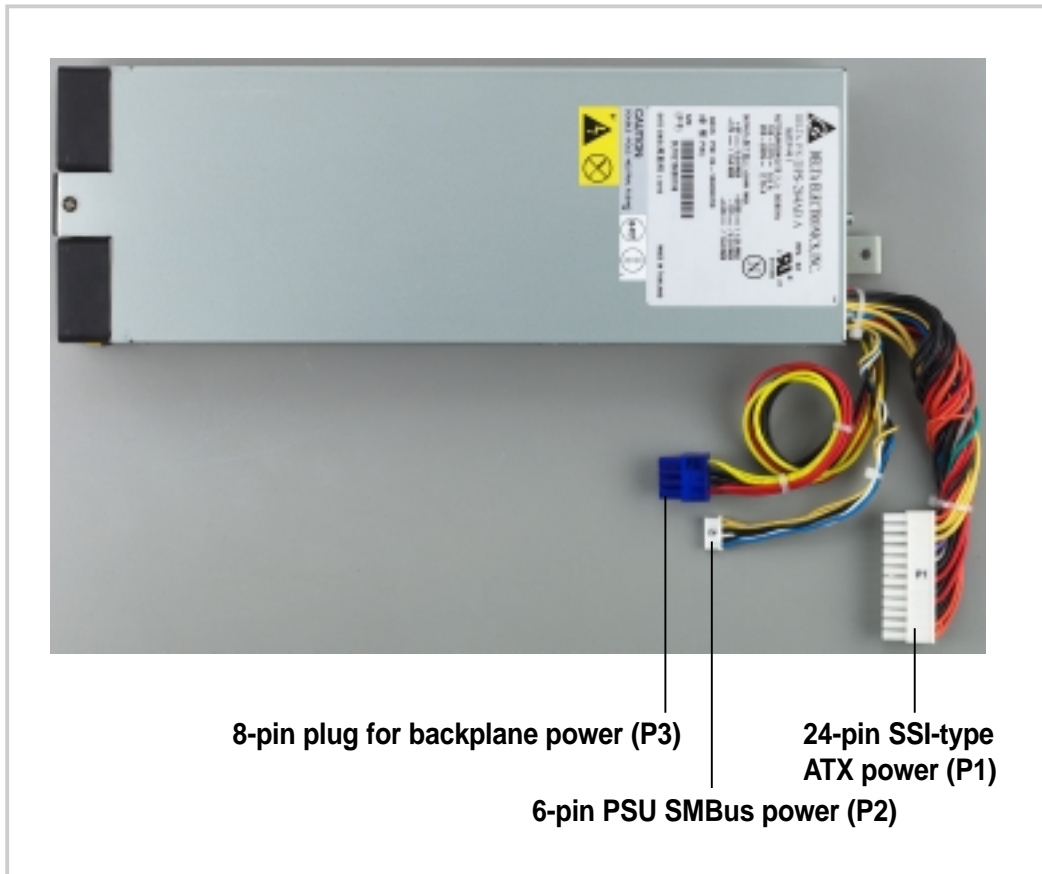

A.2 Specifications

Input Characteristics

Input Voltage Range	Min	Nom	Max
Range 1	90V	115V	140V
Range 2	180V	230V	264V
Input Frequency Range	47 Hz to 63 Hz		
Maximum Input ac Current	5.5A max at 115Vac 2.75A max. at 230Vac, maximum load		
Inrush Current	18A cold start 18A warm start		
Efficiency	65% min. at nominal input, maximum load		

Output Characteristics

Output Voltage	Load Range		Regulation		Ripple
	Min	Max	Min	Max	Max
+5V	0.5A	9.5A	-5%	+5%	50mV _{p-p}
+12V	2.0A	15.0A	-5%	+5%	120mV _{p-p}
-12V	0A	0.2A	-10%	+10%	200mV _{p-p}
+5VSB	0A	1.5A	-5%	+5%	100mV _{p-p}
+3V3	1.0A	14.0A	-5%	+5%	50mV _{p-p}

Over-Voltage Protection (OVP)

Output Voltage	Maximum Voltage
+5V	7V
+12V	15.6V
+3.3V	5V
+5VSB	7V
-12V	-15.6V



NOTE

The power supply will shut down and latch off for shorting +5V, +12V, -12V, or +3.3V. By shorting +5VSB, the power supply can latch down or automatically recover when the fault condition is removed.

Appendix B

This appendix lists the common problems that you may encounter while using the AP160R-S server. It lists the possible causes of the problems and offers solutions. You may refer to this part and try to solve simple problems before calling customer support.

Troubleshooting

B.1 Simple Fixes



NOTE

Some problems that you may encounter are not due to defects on the system or the components. These problems only requires simple troubleshooting actions that you can perform by yourself.

Problem	Action
The power LED on the server and/or the monitor do not light up	<ol style="list-style-type: none">1. Check the power cable connection on the system rear panel if properly connected.2. Make sure that the power cables are connected to a grounded power outlet.3. Press the power button to make sure that the system is turned on.4. Remove the system top cover and check if the bridge board is properly connected to the motherboard and backplane board through the BPCON connectors. Make sure that the bridge board is secured with four screws.
The keyboard does not work	Check the keyboard cable if properly connected to the keyboard port.
The mouse does not work	Check the mouse cable if properly connected to the mouse port.

Problem	Action
<p>The system does not perform power-on self tests (POST) after it was turned on</p>	<ol style="list-style-type: none"> 1. Check the memory modules and make sure you installed the DIMMs the system supports. 2. Make sure that the DIMMs are properly installed on the sockets.
<p>The system continuously beeps after it was turned on</p>	<ol style="list-style-type: none"> 1. Check the memory modules and make sure you installed the DIMMs the system supports. 2. Make sure that the DIMMs are properly installed on the sockets.
<p>The message “Non-system disk or disk error” appears</p>	<ol style="list-style-type: none"> 1. Check if a bootable HDD is active. 2. Check if the HDDs are properly installed and connected to the SCSI connectors on the backplane.
<p>Network connection not available</p>	<p>Make sure the network cable is connected to the RJ-45 port on the rear panel.</p>

Free Manuals Download Website

<http://myh66.com>

<http://usermanuals.us>

<http://www.somanuals.com>

<http://www.4manuals.cc>

<http://www.manual-lib.com>

<http://www.404manual.com>

<http://www.luxmanual.com>

<http://aubethermostatmanual.com>

Golf course search by state

<http://golfingnear.com>

Email search by domain

<http://emailbydomain.com>

Auto manuals search

<http://auto.somanuals.com>

TV manuals search

<http://tv.somanuals.com>