

P5ND2

ASUS[®]

Motherboard

E2493

**First Edition
April 2006**

Copyright © 2006 ASUSTeK COMPUTER INC. All Rights Reserved.

No part of this manual, including the products and software described in it, may be reproduced, transmitted, transcribed, stored in a retrieval system, or translated into any language in any form or by any means, except documentation kept by the purchaser for backup purposes, without the express written permission of ASUSTeK COMPUTER INC. ("ASUS").

Product warranty or service will not be extended if: (1) the product is repaired, modified or altered, unless such repair, modification or alteration is authorized in writing by ASUS; or (2) the serial number of the product is defaced or missing.

ASUS PROVIDES THIS MANUAL "AS IS" WITHOUT WARRANTY OF ANY KIND, EITHER EXPRESS OR IMPLIED, INCLUDING BUT NOT LIMITED TO THE IMPLIED WARRANTIES OR CONDITIONS OF MERCHANTABILITY OR FITNESS FOR A PARTICULAR PURPOSE. IN NO EVENT SHALL ASUS, ITS DIRECTORS, OFFICERS, EMPLOYEES OR AGENTS BE LIABLE FOR ANY INDIRECT, SPECIAL, INCIDENTAL, OR CONSEQUENTIAL DAMAGES (INCLUDING DAMAGES FOR LOSS OF PROFITS, LOSS OF BUSINESS, LOSS OF USE OR DATA, INTERRUPTION OF BUSINESS AND THE LIKE), EVEN IF ASUS HAS BEEN ADVISED OF THE POSSIBILITY OF SUCH DAMAGES ARISING FROM ANY DEFECT OR ERROR IN THIS MANUAL OR PRODUCT.

SPECIFICATIONS AND INFORMATION CONTAINED IN THIS MANUAL ARE FURNISHED FOR INFORMATIONAL USE ONLY, AND ARE SUBJECT TO CHANGE AT ANY TIME WITHOUT NOTICE, AND SHOULD NOT BE CONSTRUED AS A COMMITMENT BY ASUS. ASUS ASSUMES NO RESPONSIBILITY OR LIABILITY FOR ANY ERRORS OR INACCURACIES THAT MAY APPEAR IN THIS MANUAL, INCLUDING THE PRODUCTS AND SOFTWARE DESCRIBED IN IT.

Products and corporate names appearing in this manual may or may not be registered trademarks or copyrights of their respective companies, and are used only for identification or explanation and to the owners' benefit, without intent to infringe.

Contents

Notices	vi
Safety information	vii
About this guide.....	viii
P5ND2 specifications summary.....	x

Chapter 1: Product introduction

1.1	Welcome!	1-2
1.2	Package contents	1-2
1.3	Special features	1-3
	1.3.1 Product highlights	1-3
	1.3.2 Innovative ASUS features	1-5
1.4	Before you proceed	1-6
1.5	Motherboard overview	1-7
	1.5.1 Placement direction	1-7
	1.5.2 Screw holes.....	1-7
	1.5.3 Motherboard layout	1-8
1.6	Central Processing Unit (CPU)	1-9
	1.6.1 Installing the CPU.....	1-9
	1.6.2 Installing the CPU heatsink and fan.....	1-9
	1.6.3 Uninstalling the CPU heatsink and fan.....	1-14
1.7	System memory.....	1-16
	1.7.1 Overview	1-16
	1.7.2 Memory configurations	1-16
	1.7.3 Installing a DIMM	1-20
	1.7.4 Removing a DIMM.....	1-20
1.8	Expansion slots	1-21
	1.8.1 Installing an expansion card	1-21
	1.8.2 Configuring an expansion card	1-21
	1.8.3 Interrupt assignments.....	1-22
	1.8.4 PCI slots.....	1-23
	1.8.5 PCI Express x1 slot	1-23
	1.8.6 PCI Express x16 slot	1-23
1.9	Jumpers	1-24
1.10	Connectors	1-26
	1.10.1 Rear panel connectors	1-26
	1.10.2 Internal connectors.....	1-27

Contents

Chapter 2: BIOS setup

2.1	Managing and updating your BIOS	2-2
2.1.1	Creating a bootable floppy disk	2-2
2.1.2	Updating the BIOS.....	2-3
2.1.3	Saving the current BIOS file	2-5
2.1.4	ASUS CrashFree BIOS 2 utility	2-6
2.1.5	ASUS EZ Flash utility	2-8
2.1.6	ASUS Update utility	2-9
2.2	BIOS setup program.....	2-12
2.2.1	BIOS menu screen.....	2-13
2.2.2	Menu bar	2-13
2.2.3	Legend bar.....	2-14
2.2.4	Menu items	2-14
2.2.5	Sub-menu items.....	2-14
2.2.6	Configuration fields.....	2-14
2.2.7	Pop-up window.....	2-15
2.2.8	General help	2-15
2.3	Main menu.....	2-16
2.3.1	System Time	2-16
2.3.2	System Date	2-16
2.3.3	Legacy Diskette A	2-16
2.3.4	Primary and Secondary IDE Master/Slave	2-17
2.3.5	First, Second, Third, Fourth SATA Master	2-19
2.3.6	HDD SMART Monitoring.....	2-20
2.3.7	Installed Memory.....	2-20
2.3.8	Usable Memory.....	2-20
2.4	Advanced menu	2-21
2.4.1	JumperFree Configuration.....	2-21
2.4.2	CPU Configuration	2-26
2.4.3	Chipset.....	2-28
2.4.4	PCI/PnP	2-30
2.4.5	Onboard Devices Configuration.....	2-30
2.4.6	USB Configuration	2-34
2.5	Power menu	2-35
2.5.1	ACPI Suspend Type	2-35
2.5.2	ACPI APIC Support	2-35

Contents

2.5.3	APM Configuration	2-36
2.5.4	Hardware Monitor.....	2-38
2.6	Boot menu	2-39
2.6.1	Boot Device Priority	2-39
2.6.2	Removable Drives.....	2-40
2.6.3	Boot Settings Configuration	2-40
2.6.4	Security.....	2-42
2.7	Exit menu.....	2-44

Chapter 3:Software Support

3.1	Installing an operating system.....	3-2
3.2	Support CD information	3-2
3.2.1	Running the support CD.....	3-2
3.2.2	Drivers menu.....	3-3
3.2.3	Utilities menu	3-4
3.2.4	Make Disk menu	3-5
3.2.5	Manuals menu	3-6
3.2.6	ASUS Contact information.....	3-7

Notices

Federal Communications Commission Statement

This device complies with Part 15 of the FCC Rules. Operation is subject to the following two conditions:

- This device may not cause harmful interference, and
- This device must accept any interference received including interference that may cause undesired operation.

This equipment has been tested and found to comply with the limits for a Class B digital device, pursuant to Part 15 of the FCC Rules. These limits are designed to provide reasonable protection against harmful interference in a residential installation. This equipment generates, uses and can radiate radio frequency energy and, if not installed and used in accordance with manufacturer's instructions, may cause harmful interference to radio communications. However, there is no guarantee that interference will not occur in a particular installation. If this equipment does cause harmful interference to radio or television reception, which can be determined by turning the equipment off and on, the user is encouraged to try to correct the interference by one or more of the following measures:

- Reorient or relocate the receiving antenna.
- Increase the separation between the equipment and receiver.
- Connect the equipment to an outlet on a circuit different from that to which the receiver is connected.
- Consult the dealer or an experienced radio/TV technician for help.



The use of shielded cables for connection of the monitor to the graphics card is required to assure compliance with FCC regulations. Changes or modifications to this unit not expressly approved by the party responsible for compliance could void the user's authority to operate this equipment.

Canadian Department of Communications Statement

This digital apparatus does not exceed the Class B limits for radio noise emissions from digital apparatus set out in the Radio Interference Regulations of the Canadian Department of Communications.

This class B digital apparatus complies with Canadian ICES-003.

Safety information

Electrical safety

- To prevent electrical shock hazard, disconnect the power cable from the electrical outlet before relocating the system.
- When adding or removing devices to or from the system, ensure that the power cables for the devices are unplugged before the signal cables are connected. If possible, disconnect all power cables from the existing system before you add a device.
- Before connecting or removing signal cables from the motherboard, ensure that all power cables are unplugged.
- Seek professional assistance before using an adapter or extension cord. These devices could interrupt the grounding circuit.
- Make sure that your power supply is set to the correct voltage in your area. If you are not sure about the voltage of the electrical outlet you are using, contact your local power company.
- If the power supply is broken, do not try to fix it by yourself. Contact a qualified service technician or your retailer.

Operation safety

- Before installing the motherboard and adding devices on it, carefully read all the manuals that came with the package.
- Before using the product, make sure all cables are correctly connected and the power cables are not damaged. If you detect any damage, contact your dealer immediately.
- To avoid short circuits, keep paper clips, screws, and staples away from connectors, slots, sockets and circuitry.
- Avoid dust, humidity, and temperature extremes. Do not place the product in any area where it may become wet.
- Place the product on a stable surface.
- If you encounter technical problems with the product, contact a qualified service technician or your retailer.



The symbol of the crossed out wheeled bin indicates that the product (electrical and electronic equipment) should not be placed in municipal waste. Check local regulations for disposal of electronic products.

About this guide

This user guide contains the information you need when installing and configuring the motherboard.

How this guide is organized

This guide contains the following parts:

- **Chapter 1: Product introduction**
This chapter describes the features of the motherboard and the new technology it supports.
- **Chapter 2: BIOS setup**
This chapter tells how to change system settings through the BIOS Setup menus. Detailed descriptions of the BIOS parameters are also provided.
- **Chapter 3: Software support**
This chapter describes the contents of the support CD that comes with the motherboard package.

Where to find more information

Refer to the following sources for additional information and for product and software updates.

1. ASUS websites

The ASUS website provides updated information on ASUS hardware and software products. Refer to the ASUS contact information.

2. Optional documentation

Your product package may include optional documentation, such as warranty flyers, that may have been added by your dealer. These documents are not part of the standard package.

Conventions used in this guide

To make sure that you perform certain tasks properly, take note of the following symbols used throughout this manual.



DANGER/WARNING: Information to prevent injury to yourself when trying to complete a task.



CAUTION: Information to prevent damage to the components when trying to complete a task.



IMPORTANT: Instructions that you **MUST** follow to complete a task.



NOTE: Tips and additional information to help you complete a task.

Typography

Bold text

Indicates a menu or an item to select.

Italics

Used to emphasize a word or a phrase.

<Key>

Keys enclosed in the less-than and greater-than sign means that you must press the enclosed key.

Example: <Enter> means that you must press the Enter or Return key.

<Key1>+<Key2>+<Key3>

If you must press two or more keys simultaneously, the key names are linked with a plus sign (+).

Example: <Ctrl>+<Alt>+<D>

Command

Means that you must type the command exactly as shown, then supply the required item or value enclosed in brackets.

Example: At the DOS prompt, type the command line:

```
afudos /i [filename]  
afudos /iP5ND2.ROM
```

P5ND2 specifications summary

CPU	LGA775 socket for Intel® Pentium® D/Intel® Pentium® 4/ Intel® Celeron® processors Compatible with Intel® PCG 05B/05A and 04B/04A processors Supports Intel® Dual-core Technology Supports Enhanced Intel SpeedStep® Technology (EIST) Supports Intel® Hyper-Threading Technology
Chipset	Northbridge: NVIDIA® C19 Southbridge: NVIDIA® MCP51
Front Side Bus	800/533 MHz
Memory	Dual-channel memory architecture 4 x 240-pin DIMM sockets support unbuffered non-ECC DDR2 667/533 memory modules Supports up to 16 GB system memory
Expansion slots	1 x PCI Express x16 slot for discrete graphics card 3 x PCI Express x1 slots 2 x PCI slots
AI Audio	ADI® AD1986A 6-channel CODEC 1 x Coaxial S/PDIF out port Supports Jack Sensing and Enumeration Technology
Storage	NVIDIA® MCP51 chipset supports: <ul style="list-style-type: none"> - 2 x Ultra DMA 133/100/66 - 4 x Serial ATA 3Gb/s devices - RAID 0, RAID 1, RAID 0+1, RAID 5 and JBOD
Gigabit LAN	Realtek® RTL8111B Gigabit LAN controller - AI NET
USB	Supports up to 8 USB 2.0 ports
Overclocking features	CPU Lock Free ASUS AI Overclocking (Intelligent Frequency Tuner) Precision Tweaker supports: <ul style="list-style-type: none"> - DIMM voltage: 4-step DRAM voltage control - Core voltage: Adjustable CPU voltage at 0.0125 V - Stepless Frequency Selection (SFS) allows FSB tuning from 133MHz to 400 MHz at 1MHz increment Adjustable FSB/DDR2/PCIe frequencies with fixed 33Hz PCI frequencies
Special features	ASUS CrashFree BIOS 2 ASUS MyLogo2 ASUS EZ Flash

(continued on the next page)

P5ND2 specifications summary

BIOS features	4 MB Flash ROM, Award BIOS, PnP, DMi2.0, SM BIOS 2.3, WfM2.0, ASUS EZ Flash, ASUS CrashFree BIOS2
Power Requirement	ATX power supply (with 24-pin and 4-pin 12V plugs) ATX 12V 2.0 compliant
Rear panel	1 x Parallel port 1 x Serial port 1 x LAN (RJ-45) ports USB 2.0 ports 1 x Coaxial S/PDIF Out port 1 x PS/2 keyboard port 1 x PS/2 mouse port 6-channel audio ports
Internal connectors	1 x Floppy disk drive connector 2 x IDE connectors 4 x Serial ATA connectors 1 x 24-pin ATX power connector 1 x 4-pin ATX 12 V power connector 2 x USB connectors for additional four USB 2.0 ports 1 x S/PDIF connector 2 x Internal audio connectors (CD, AUX) 1 x GAME connector 1 x Chassis intrusion connector 1 x Front panel audio connector CPU, Chassis, Power fan connectors System panel connector
Support CD contents	Device drivers ASUS PC Probe II ASUS Update ASUS Screen saver Anti-Virus software
Form Factor	ATX form factor: 12 in x 8 in

* Specifications are subject to change without notice.

This chapter describes the motherboard features and the new technologies it supports.

1 Product introduction

1.1 Welcome!

Thank you for buying an ASUS® P5ND2 motherboard!

The motherboard delivers a host of new features and latest technologies, making it another standout in the long line of ASUS quality motherboards!

Before you start installing the motherboard, and hardware devices on it, check the items in your package with the list below.

1.2 Package contents

Check your motherboard package for the following items.

Motherboard	P5ND2	
Cables	1 x Serial ATA cable set	✓
	1 x Ultra DMA 133/100/66 cable	✓
	40-conductor IDE cable	✓
	Floppy disk drive cable	✓
Accessories	I/O shield	✓
Application CD	ASUS motherboard support CD	✓
Documentation	User guide	✓



If any of the above items is damaged or missing, contact your retailer.

1.3 Special features

1.3.1 Product highlights

Latest processor technology

The motherboard comes with a 775-pin surface mount Land Grid Array (LGA) socket designed for the Intel® Pentium® D, Intel® Pentium® 4, and Intel® Celeron® processors in the 775-land package. The motherboard supports Intel® processors with 800/533 MHz Front Side Bus (FSB). The motherboard also supports the Intel® Hyper-Threading Technology, Intel® Dual-Core Technology and is fully compatible with Intel® 05B/05A and 04B/04A processors. See page 1-9 for details.

Intel® Dual-Core Technology CPU support

The motherboard supports dual-core processors containing two physical CPU cores with dedicated L2 caches to meet demands for more powerful processing.

Enhanced Intel SpeedStep® Technology (EIST)

The Enhanced Intel SpeedStep® Technology (EIST) intelligently manages the CPU resources by automatically adjusting the CPU voltage and core frequency depending on the CPU loading and system speed or power requirement.

Dual-channel DDR2 memory support

The motherboard supports DDR2 memory for flexible system upgrade and to meet the higher bandwidth requirements of the latest 3D graphics, multimedia, and Internet applications. The dual-channel architecture allows memory bandwidths of up to 8.5 GB/s for DDR2. See page 1-16 for details.

PCI Express™ interface

The motherboard fully supports PCI Express, the latest I/O interconnect technology that speeds up the PCI bus. PCI Express features point-to-point serial interconnections between devices and allows higher clockspeeds by carrying data in packets. This high speed interface is software compatible with existing PCI specifications. See pages 1-23 for details.

CPU Lock Free

This feature allows you to adjust the CPU multiplier to 14x. Setting the appropriate BIOS setting automatically reduces the CPU multiplier value for more flexibility when increasing external FSB.

USB 2.0 technology

The motherboard implements the Universal Serial Bus (USB) 2.0 specification, dramatically increasing the connection speed from the 12 Mbps bandwidth on USB 1.1 to a fast 480 Mbps on USB 2.0. USB 2.0 is backward compatible with USB 1.1. See pages 1-25 and 1-30 for details.

Serial ATA 3Gb/s technology

The motherboard supports the Serial ATA 3 Gb/s technology through the Serial ATA interfaces. The Serial ATA 3 Gb/s specification provides twice the bandwidth of the current Serial ATA products with a host of new features, including Native Command Queueing (NCQ), and Power Management (PM) Implementation Algorithm. Serial ATA allows for thinner, more flexible cables with lower pin count, reduced voltage requirement. See page 1-29 for details.

1.3.2 Innovative ASUS features

Precision Tweaker



This feature allows you to fine tune the CPU/memory voltage and gradually increase the memory Front Side Bus (FSB) and PCI Express frequency at 1MHz increment to achieve maximum system performance.

Fanless Design



The ASUS fanless design allows multi-directional heat flow from major thermal sources in the motherboard to lower overall system temperature, resulting in quieter operation and longer system life.

CrashFree BIOS 2



This feature allows you to restore the original BIOS data from the support CD in case when the BIOS codes and data are corrupted. This protection eliminates the need to buy a replacement ROM chip. See page 2-6 for details.

ASUS MyLogo2™



This new feature present in the motherboard allows you to personalize and add style to your system with customizable boot logos. See page 2-41 for details.

1.4 Before you proceed

Take note of the following precautions before you install motherboard components or change any motherboard settings.



- Unplug the power cord from the wall socket before touching any component.
- Use a grounded wrist strap or touch a safely grounded object or to a metal object, such as the power supply case, before handling components to avoid damaging them due to static electricity.
- Hold components by the edges to avoid touching the ICs on them.
- Whenever you uninstall any component, place it on a grounded antistatic pad or in the bag that came with the component.
- Before you install or remove any component, ensure that the ATX power supply is switched off or the power cord is detached from the power supply. Failure to do so may cause severe damage to the motherboard, peripherals, and/or components.

Onboard LED

The motherboard comes with a standby power LED. The green LED lights up to indicate that the system is ON, in sleep mode, or in soft-off mode. This is a reminder that you should shut down the system and unplug the power cable before removing or plugging in any motherboard component. The illustration below shows the location of the onboard LED.

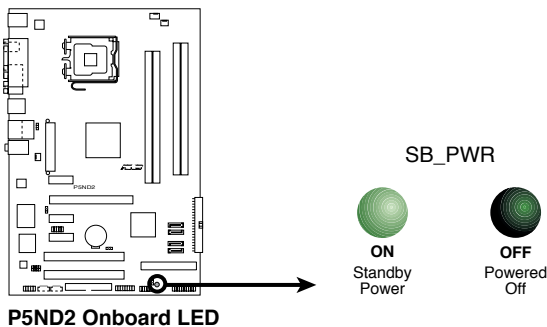

1.5 Motherboard overview

Before you install the motherboard, study the configuration of your chassis to ensure that the motherboard fits into it.



Make sure to unplug the power cord before installing or removing the motherboard. Failure to do so can cause you physical injury and damage motherboard components.

1.5.1 Placement direction

When installing the motherboard, make sure that you place it into the chassis in the correct orientation. The edge with external ports goes to the rear part of the chassis as indicated in the image below.

1.5.2 Screw holes

Place six (6) screws into the holes indicated by circles to secure the motherboard to the chassis.



Do not overtighten the screws! Doing so can damage the motherboard.

Place this side towards
the rear of the chassis

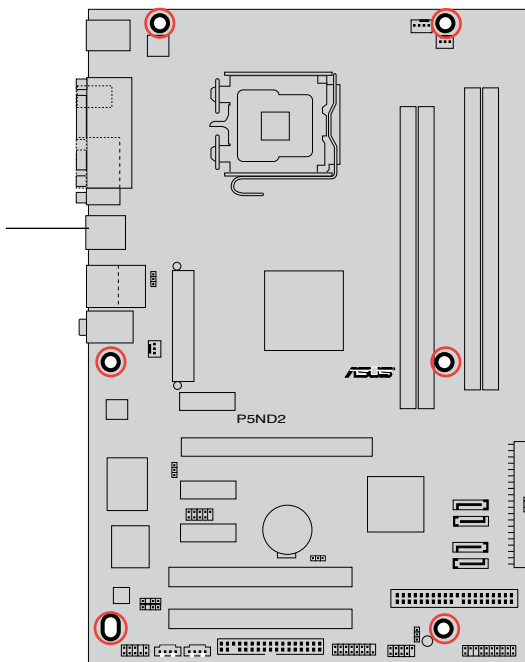

1.5.3 Motherboard layout

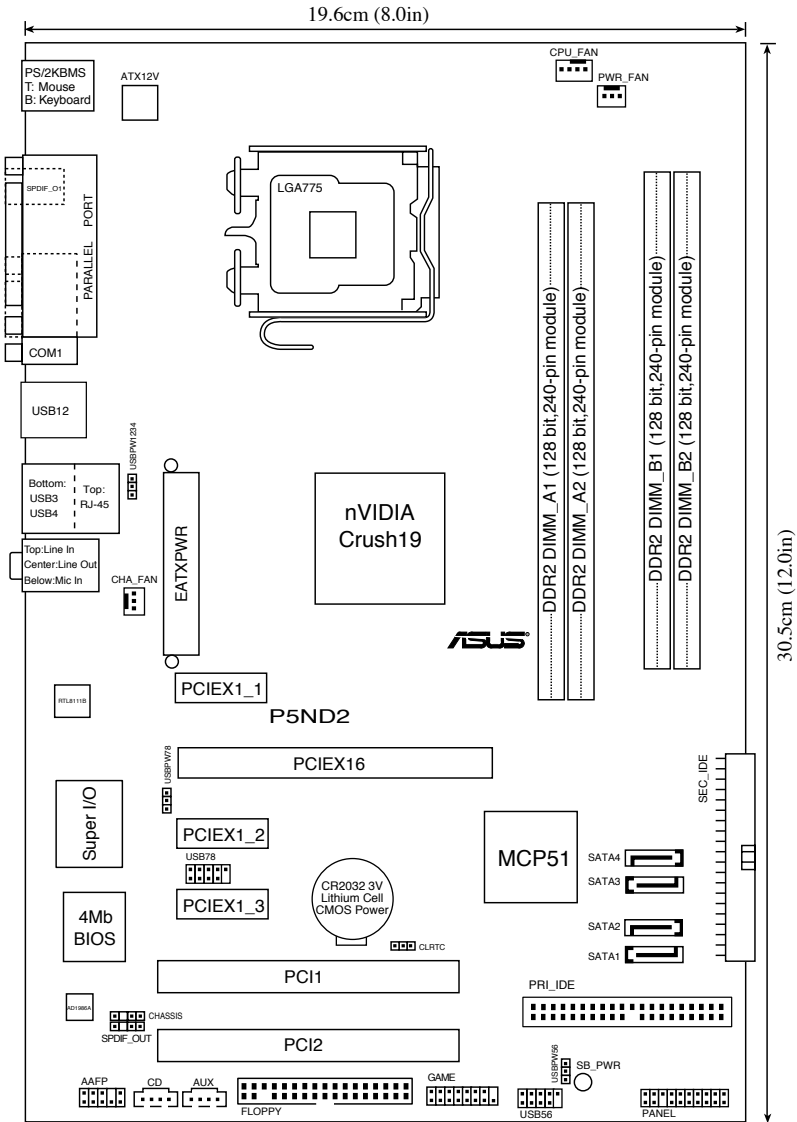

1.6 Central Processing Unit (CPU)

The motherboard comes with a surface mount LGA775 socket designed for the Intel® Pentium® D, Intel® Pentium® 4 and Intel® Celeron® processors in the 775-land package.



- Install a chassis fan with at least a speed of 2400 rpm and 8 CFM turnrate when using a dual-core CPU to ensure system stability. Overheating can permanently damage the system and/or CPU.
- Upon purchase of the motherboard, make sure that the PnP cap is on the socket and the socket contacts are not bent. Contact your retailer immediately if the PnP cap is missing, or if you see any damage to the PnP cap/socket contacts/motherboard components. ASUS will shoulder the cost of repair only if the damage is shipment/transit-related.
- Keep the cap after installing the motherboard. ASUS will process Return Merchandise Authorization (RMA) requests only if the motherboard comes with the cap on the LGA775 socket.
- The product warranty does not cover damage to the socket contacts resulting from incorrect CPU installation/removal, or misplacement/loss/incorrect removal of the PnP cap.

1.6.1 Installing the CPU

To install a CPU:

1. Locate the CPU socket on the motherboard.

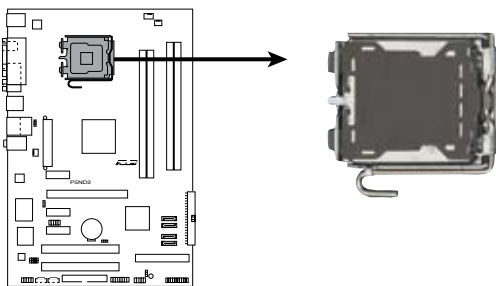

P5ND2 CPU Socket 775



Before installing the CPU, make sure that the cam box is facing towards you and the load lever is on your left.

- Press the load lever with your thumb (A), then move it to the left (B) until it is released from the retention tab.

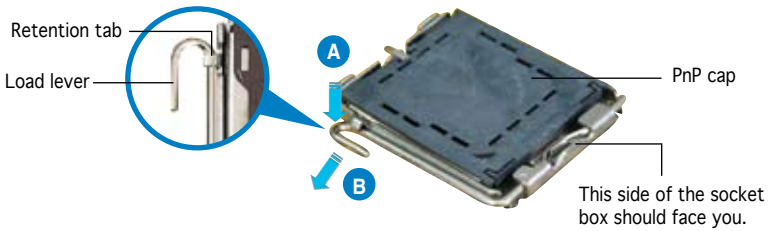

To prevent damage to the socket pins, do not remove the PnP cap unless you are installing a CPU.

- Lift the load lever in the direction of the arrow to a 135° angle.

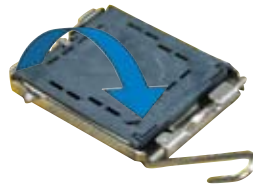

- Lift the load plate with your thumb and forefinger to a 100° angle (A), then push the PnP cap from the load plate window to remove (B).

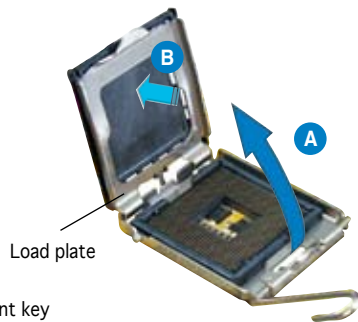

- Position the CPU over the socket, making sure that the gold triangle is on the bottom-left corner of the socket. The socket alignment key should fit into the CPU notch.

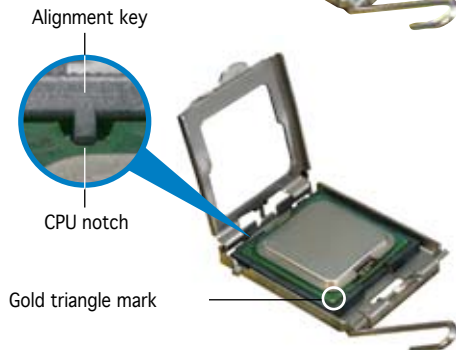



The CPU fits in only one correct orientation. DO NOT force the CPU into the socket to prevent bending the connectors on the socket and damaging the CPU!

6. Close the load plate (A), then push the load lever (B) until it snaps into the retention tab.



The motherboard supports Intel® Pentium® 4 LGA775 processors with the Enhanced Intel SpeedStep® Technology (EIST), and Hyper-Threading Technology.

1.6.2 Installing the CPU heatsink and fan

Intel® LGA775 processors require a specially designed heatsink and fan assembly to ensure optimum thermal condition and performance.



- When you buy a boxed Intel® processor, the package includes the CPU fan and heatsink assembly. **If you buy a CPU separately, make sure that you use only Intel®-certified multi-directional heatsink and fan.**
- Your Intel® LGA775 processor heatsink and fan assembly comes in a push-pin design and requires no tool to install.
- If you purchased a separate CPU heatsink and fan assembly, make sure that you have properly applied Thermal Interface Material to the CPU heatsink or CPU before you install the heatsink and fan assembly.



Make sure that you have installed the motherboard to the chassis before you install the CPU fan and heatsink assembly.

To install the CPU heatsink and fan:

1. Place the heatsink on top of the installed CPU, making sure that the four fasteners match the holes on the motherboard.



Orient the heatsink and fan assembly such that the CPU fan cable is closest to the CPU fan connector.

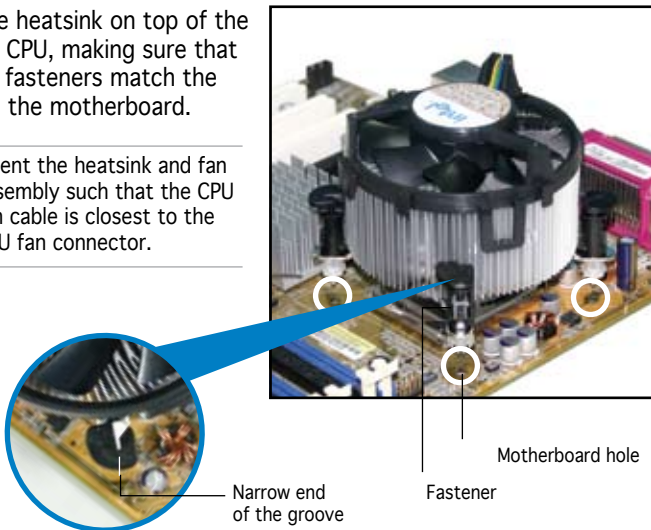

Make sure to orient each fastener with the narrow end of the groove pointing outward. (The photo shows the groove shaded for emphasis.)

2. Push down two fasteners at a time in a diagonal sequence to secure the heatsink and fan assembly in place.

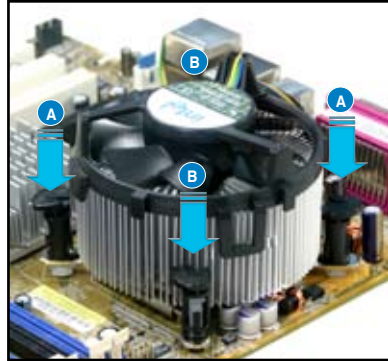
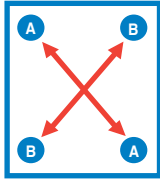

3. Connect the CPU fan cable to the connector on the motherboard labeled CPU_FAN.

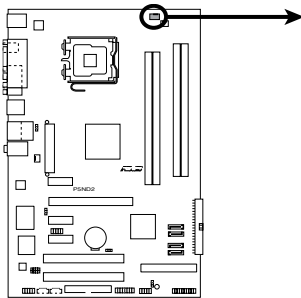

CPU_FAN



P5ND2 CPU Fan Connector



- Do not forget to connect the CPU fan connector! Hardware monitoring errors can occur if you fail to plug this connector.
- The retention module of some third-party CPU heatsink and fan can interfere with chipset components at the bottom of the board. Before purchasing a separate CPU heatsink and fan, make sure that it will not interfere with the chipset components.

1.6.3 Uninstalling the CPU heatsink and fan

To uninstall the CPU heatsink and fan:

1. Disconnect the CPU fan cable from the connector on the motherboard.
2. Rotate each fastener counterclockwise.

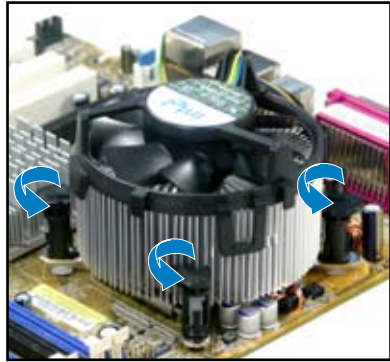

3. Pull up two fasteners at a time in a diagonal sequence to disengage the heatsink and fan assembly from the motherboard.

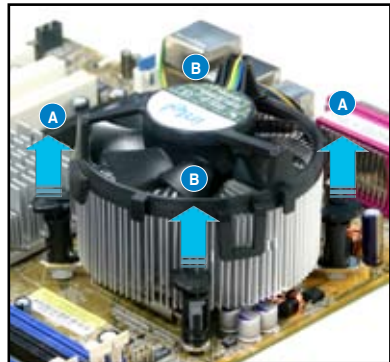
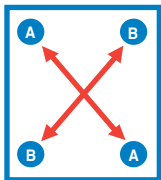

4. Carefully remove the heatsink and fan assembly from the motherboard.



5. Rotate each fastener clockwise to ensure correct orientation when reinstalling.

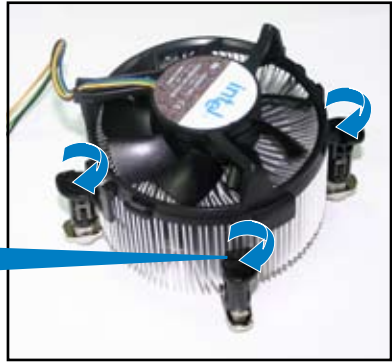

Narrow end of the groove



The narrow end of the groove should point outward after resetting. (The photo shows the groove shaded for emphasis.)



Refer to the documentation in the boxed or stand-alone CPU fan package for detailed information on CPU fan installation.

1.7 System memory

1.7.1 Overview

The motherboard comes with four Double Data Rate 2 (DDR2) Dual Inline Memory Modules (DIMM) sockets.

A DDR2 module has the same physical dimensions as a DDR DIMM but has a 240-pin footprint compared to the 184-pin DDR DIMM. DDR2 DIMMs are notched differently to prevent installation on a DDR DIMM socket.

The figure illustrates the location of the DDR2 DIMM sockets:

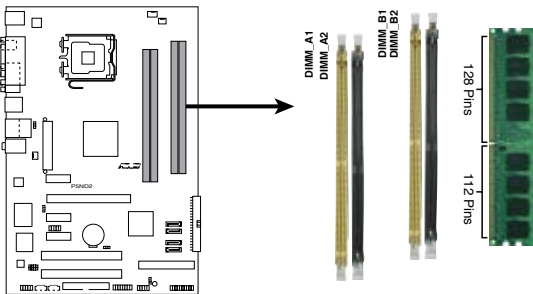

P5ND2 240-pin DDR2 DIMM Sockets

Channel	Sockets
Channel A	DIMM_A1 and DIMM_A2
Channel B	DIMM_B1 and DIMM_B2

1.7.2 Memory configurations

You may install 256 MB, 512 MB, 1 GB, 2 GB and 4 GB unbuffered non-ECC DDR2 DIMMs into the DIMM sockets.



- For dual-channel configuration, the total size of memory module(s) installed per channel must be the same (DIMM_A1 + DIMM_A2 = DIMM_B1 + DIMM_B2).
- Always install DIMMs with the same CAS latency. For optimum compatibility, it is recommended that you obtain memory modules from the same vendor. Refer to the DDR2 Qualified Vendors List on the next page for details.
- If you install four 1GB memory modules, the system may only recognize less than 3 GB because the address space is reserved for other critical functions. This limitation appears on Windows® XP 32-bit operation system which does not support Physical Address Extension (PAE).
- If you install Windows® XP 32-bit operation system, a total memory of less than 3GB is recommended.



Notes on memory limitations

The motherboard can support up to 16 GB on the operating systems listed below. You may install a maximum of 2 GB DIMMs on each slot, but only DDR2-533 2 GB density modules are available for this configuration.

32-bit	64-bit
Windows® 2000 Advanced Server	Windows® Server 2003 Standard x64 Edition
Windows® Server 2003 Enterprise Edition	Windows® XP Professional x64 Edition
	Windows® Server 2003 Enterprise x64 Edition

Qualified Vendors Lists (QVL)

DDR2 with 667 MHz capability

Size	Vendor	Chip No.	Side(s)	Part No.	DIMM support		
					A	B	C
512MB	KINGSTON	E5108AE-6E-E	SS	KVR667D2N5/512	•	•	•
1024MB	KINGSTON	E5108AE-6E-E	DS	KVR667D2N5/1G	•	•	
512MB	KINGSTON	E5108AE-6E-E	SS	KVR667D2E5/512	•	•	•
256MB	KINGSTON	HYB18T256800AF3	SS	KVR667D2N5/256	•	•	•
256MB	SAMSUNG	K4T56083QF-ZCE6	SS	M378T3253FZ0-CE6	•	•	•
512MB	SAMSUNG	K4T56083QF-ZCE6	DS	M378T6453FZ0-CE6	•	•	
256MB	SAMSUNG	K4T51163QC-ZCE6	SS	M378T3354CZ0-CE6	•	•	•
512MB	SAMSUNG	ZCE6K4T51083QC	SS	M378T6553CZ0-CE6	•	•	•
1024MB	SAMSUNG	ZCE6K4T51083QC	DS	M378T2953CZ0-CE6	•	•	
512MB	MICRON	4VB41D9CZM	DS	MT16HTF6464AY-667B4	•	•	•
256MB	Infineon	HYB18T512160AF-3S	SS	HYS64T32000HU-3S-A	•	•	•
512MB	Infineon	HYB18T512800AF3S	SS	HYS64T64000HU-3S-A	•	•	•
1024MB	Infineon	HYB18T512800AF3S	DS	HYS64T128020HU-3S-A	•	•	
512MB	Hynix	HY5PS12821AFP-Y5	SS	HYMP564U64AP8-Y5	•	•	
1024MB	Hynix	HY5PS12821AFP-Y5	DS	HYMP512U64AP8-Y5	•	•	
512MB	Hynix	HY5PS12821AFP-Y4	SS	HYMP564U64AP8-Y4	•	•	•
1024MB	Hynix	HY5PS12821AFP-Y4	DS	HYMP512U64AP8-Y4	•	•	
256MB	ELPIDA	E2508AB-GE-E	SS	EBE25UC8ABFA-6E-E	•	•	•
512MB	ELPIDA	E5108AE-GE-E	SS	EBE51UD8AEFA-6E-E	•	•	•
512MB	crucial	Heat-Sink Package	DS	BL6464AA664.16FB	•	•	
1024MB	crucial	Heat-Sink Package	DS	BL12864AA664.16FA		•	
512MB	crucial	Heat-Sink Package	DS	BL6464AL664.16FB	•	•	
1024MB	crucial	Heat-Sink Package	DS	BL12864AL664.16FA	•	•	
512MB	Kingmax	E5108AE-6E-E	SS	KLCC28F-A8EB5	•	•	•
1024MB	Kingmax	E5108AE-6E-E	DS	KLCD48F-A8EB5	•	•	
1024MB	Apacer	E5108AE-6E-E	DS	78.01092.420	•	•	
512MB	A-DATA	E5108AE-6E-E	SS	M20EL5G3H3160B1COZ	•	•	•
512MB	TwinMOS	E5108AE-GE-E	SS	8G-25JK5-EBT	•	•	•
512MB	GEIL	Heat-Sink Package	SS	GX21GB5300UDC	•	•	•
512MB	GEIL	Heat-Sink Package	SS	GX21GB5300DC	•	•	•
256MB	NANYA	NT5TU32M16AG-3C	SS	NT256T64UH4A0FY-3C	•	•	•
512MB	NANYA	NT5TU64M8AE-3C	SS	NT512T64U88A0BY-3C	•	•	
512MB	Elixir	N2TU51280AF-3C	SS	M2U51264TU88A0F-3C	•	•	•

(continued on the next page)

DDR2 with 667 MHz capability

Size	Vendor	Chip No	Side(s)	Part No.	DIMM support		
					A	B	C
1024MB	PQI	E5108AE-5C-E	DS	MEAD-403LA	•	•	
512MB	WINTEC	4UAI2D9CRZ	SS	39127282	•	•	•
1024MB	WINTEC	4WAIID9CWX	DS	39137282	•	•	
512MB	MDT	18D51280D-30518	SS	M512-667-8	•	•	•
1024MB	MDT	18D51280D-30528	DS	M924-667-16	•	•	
512MB	Kingbox	DD2640800-667	SS	N/A	•	•	•
1024MB	Kingbox	DD2640800-667	DS	N/A	•	•	

DDR2-533

Size	Vendor	Chip No.	Side(s)	Part No.	DIMM support		
					A	B	C
256MB	KINGSTON	E5116AB-5C-E	SS	KVR533D2N4/256	•	•	
512MB	KINGSTON	HY5PS56821F-C4	DS	KVR533D2N4/512	•	•	•
1024MB	KINGSTON	D6408TE7BL-37	DS	KVR533D2N4/1G	•	•	
2048MB	KINGSTON	E1108AA-5C-E	DS	KVR533D2N4/2G	•		
512MB	SAMSUNG	K4T51083QB-GCD5	SS	M378T6553BG0-CD5	•	•	•
256MB	SAMSUNG	K4T56083QF-GCD5	SS	M378T3253FG0-CD5	•	•	•
512MB	SAMSUNG	K4T56083QF-GCD5	DS	M378T6453FG0-CD5	•	•	
512MB	Infineon	HYB18T512800AC37	SS	HYS64T64000GU-3.7-A	•	•	•
256MB	Infineon	HYB18T512160AF-3.7	SS	HYS64T32000HU-3.7-A	•	•	•
512MB	Infineon	HYB18T512800AF37	SS	HYS64T64000HU-3.7-A	•	•	•
1024MB	Infineon	HYB18T512800AF37	DS	HYS64T128020HU-3.7-A	•	•	
2048MB	Infineon	HYB18T1G800AF-3.7	DS	HYS64T256020HU-3.7-A	•		
256MB	Infineon	HYB18T5121608BF-3.7	SS	HYS64T32000HU-3.7-B	•	•	•
512MB	Infineon	HYB18T512800BF37	SS	HYS64T64000HU-3.7-B	•	•	•
1024MB	Infineon	HYB18T512800BF37	DS	HYS64T128020HU-3.7-B	•	•	
512MB	Hynix	HY5PS12821F-C4	SS	HYMP564U648-C4	•	•	
1024MB	Hynix	HY5PS12821F-C4	DS	HYMP512U648-C4	•	•	
512MB	Hynix	HY5PS12821AFP-C3	SS	HYMP564U64AP8-C3	•	•	•
1024MB	Hynix	HY5PS12821AFP-C3	DS	HYMP512U64AP8-C3	•	•	
512MB	ELPIDA	E5108AB-5C-E	SS	EBE51UD8ABFA-5C	•	•	•
512MB	ELPIDA	E5108AB-5C-E	SS	EBE51UD8ABFA-5C-E	•	•	•
256MB	Apacer	E5116AB-5C-E	SS	7B.81077.420	•	•	•
256MB	KINGMAX	E5116AB-5C-E	SS	KLBB68F-36EP4	•	•	
512MB	KINGMAX	E5108AE-5C-E	SS	KLBC28F-A8EB4	•	•	•
1024MB	KINGMAX	E5108AE-5C-E	DS	KLBD48F-A8EB4	•	•	•
512MB	Transcend	K4T51083QB-GCD5	SS	TS64MLQ64V5J	•	•	•
1024MB	Transcend	K4T51083QB-GCD5	DS	TS128MLQ64V5J	•	•	
512MB	CENTURY	E5108AB-5C-E	SS	25V2H8EL5CB4-J43	•	•	•
256MB	elixir	N2TU51216AF-37B	SS	M2U25664TUH4A0F-37B	•	•	•
512MB	elixir	N2TU51280AF-37B	SS	M2U51264TU88A0F-37B	•		•
512MB	Aeoneon	AET960UD00-37C88X	SS	AET660UD00-370A98X	•		
512MB	Aeoneon	AET93F370AG0513	SS	AET660UD00-370A98X	•	•	•
256MB	Aeoneon	AET94F370A	SS	AET560UD00-370A98Z	•	•	•
256MB	Aeoneon	AET94F370A	SS	AET560UD00-370A98X	•	•	•

(continued on the next page)

DDR2-533

Size	Vendor	Chip No.	Side(s)	Part No.	DIMM support		
					A	B	C
512MB	Aeneon	AET93F370A	SS	AET660UD00-370A98Z	•	•	•
512MB	Aeneon	AET93F370A	SS	AET660UD00-370A98X	•	•	•
512MB	Aeneon	AET93F370	SS	AET660UD00-370A98X	•	•	•
1024MB	Aeneon	AET93F370A	DS	AET760UD00-370A98X	•	•	
256MB	NANYA	NT5TU32M16AF-37B	SS	NT256T64UH4A0F-37B	•	•	•
512MB	NANYA	NT5TU64M8AF-37B	SS	NT512T64U88A0F-37B	•	•	•
1024MB	NANYA	NT5TU64M8AF-37B	DS	NT1GT64U88A0F-37B	•	•	
1024MB	PQI	64MX8D2-E	DS	MEAB-323LA	•		
512MB	PQI	64MX8D2-E	SS	MEAB-423LA	•	•	•
512MB	TwinMOS	K4T51083QB-GCD5	SS	8D-22JB5-K2T	•	•	•
256MB	SimpleTech	858S032F25A	SS	SVM-42DR2/256	•	•	
512MB	SimpleTech	858S064F25A	DS	SVM-42DR2/512	•	•	•
1024MB	Patriot	Heat-Sink Package	SS	PDC21G5600+XBLK	•		
512MB	MDT	18D51280D-3.70S20	SS	M512-533-8	•	•	•
1024MB	MDT	18D51280D-3.70448	DS	M924-533-16		•	



Visit the ASUS website (www.asus.com) for the latest QVL.

Side(s): SS - Single-sided DS - Double-sided

DIMM support:

- A** - Supports one module inserted into either slot, in Single-channel memory configuration.
- B** - Supports one pair of modules inserted into either the yellow slots or the black slots as one pair of Dual-channel memory configuration.
- C** - Supports two pairs of modules inserted into the yellow and black slots as two pairs of Dual-channel memory configuration.

1.7.3 Installing a DIMM



Unplug the power supply before adding or removing DIMMs or other system components. Failure to do so can cause severe damage to both the motherboard and the components.

To install a DIMM:

1. Unlock a DIMM socket by pressing the retaining clips outward.
2. Align a DIMM on the socket such that the notch on the DIMM matches the break on the socket.
3. Firmly insert the DIMM into the socket until the retaining clips snap back in place and the DIMM is properly seated.

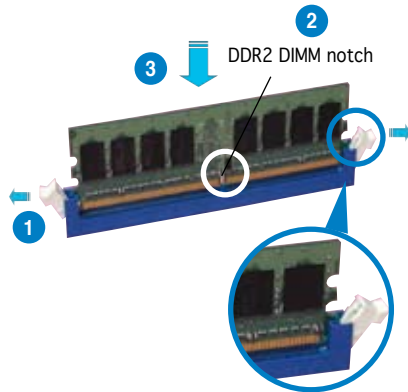

Unlocked retaining clip



- A DDR2 DIMM is keyed with a notch so that it fits in only one direction. Do not force a DIMM into a socket to avoid damaging the DIMM.
- The DDR2 DIMM sockets do not support DDR DIMMs. DO not install DDR DIMMs to the DDR2 DIMM sockets.

1.7.4 Removing a DIMM

Follow these steps to remove a DIMM.

1. Simultaneously press the retaining clips outward to unlock the DIMM.



Support the DIMM lightly with your fingers when pressing the retaining clips. The DIMM might get damaged when it flips out with extra force.

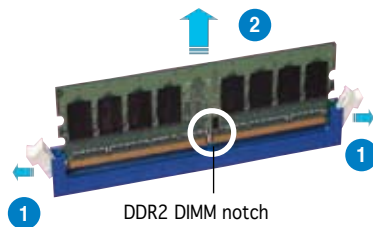

2. Remove the DIMM from the socket.

1.8 Expansion slots

In the future, you may need to install expansion cards. The following sub-sections describe the slots and the expansion cards that they support.



Make sure to unplug the power cord before adding or removing expansion cards. Failure to do so may cause you physical injury and damage motherboard components.

1.8.1 Installing an expansion card

To install an expansion card:

1. Before installing the expansion card, read the documentation that came with it and make the necessary hardware settings for the card.
2. Remove the system unit cover (if your motherboard is already installed in a chassis).
3. Remove the bracket opposite the slot that you intend to use. Keep the screw for later use.
4. Align the card connector with the slot and press firmly until the card is completely seated on the slot.
5. Secure the card to the chassis with the screw you removed earlier.
6. Replace the system cover.

1.8.2 Configuring an expansion card

After installing the expansion card, configure it by adjusting the software settings.

1. Turn on the system and change the necessary BIOS settings, if any. See Chapter 2 for information on BIOS setup.
2. Assign an IRQ to the card. Refer to the tables on the next page.
3. Install the software drivers for the expansion card.



When using PCI cards on shared slots, ensure that the drivers support “Share IRQ” or that the cards do not need IRQ assignments. Otherwise, conflicts will arise between the two PCI groups, making the system unstable and the card inoperable. Refer to the table on the next page for details.

1.8.3 Interrupt assignments

Standard interrupt assignments

IRQ	Priority	Standard Function
0	1	System Timer
1	2	Keyboard Controller
2	—	Re-direct to IRQ#9
4	12	Communications Port (COM1)*
5	13	IRQ holder for PCI steering*
6	14	Floppy Disk Controller
7	15	Printer Port (LPT1)*
8	3	System CMOS/Real Time Clock
9	4	IRQ holder for PCI steering*
10	5	IRQ holder for PCI steering*
11	6	IRQ holder for PCI steering*
12	7	PS/2 Compatible Mouse Port*
13	8	Numeric Data Processor
14	9	Primary IDE Channel
15	10	Secondary IDE Channel

* These IRQs are usually available for PCI devices.

IRQ assignments for this motherboard

	A	B	C	D	E	F	G	H
PCI Express x16 slot 1	—	—	—	—	shared	—	—	—
PCI Express x1 slot 1	—	—	—	—	shared	—	—	—
PCI Express x1 slot 2	—	—	—	—	—	used	—	—
PCI Express x1 slot 3	—	—	—	—	—	—	—	used
PCI slot 1	shared	—	—	—	—	—	—	—
PCI slot 2	—	shared	—	—	—	—	—	—
Onboard USB1.0 controller 1	shared	—	—	—	—	—	—	—
Onboard USB1.0 controller 2	—	shared	—	—	—	—	—	—
Onboard USB2.0 controller	—	—	shared	—	—	—	—	—
Onboard LAN	—	—	shared	—	—	—	—	—
Onboard IDE controller	—	—	—	—	shared	—	—	—
Onboard SATA controller	shared	—	—	—	—	—	—	—
Onboard Audio controller	shared	—	—	—	—	—	—	—

1.8.4 PCI slots

The PCI slots support cards such as a LAN card, SCSI card, USB card, and other cards that comply with PCI specifications. The figure shows a LAN card installed on a PCI slot.

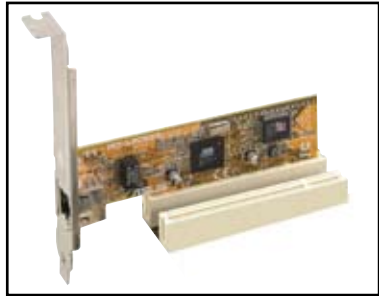

1.8.5 PCI Express x1 slot

This motherboard supports PCI Express x1 network cards, SCSI cards and other cards that comply with the PCI Express specifications. The figure shows a network card installed on the PCI Express x1 slot.

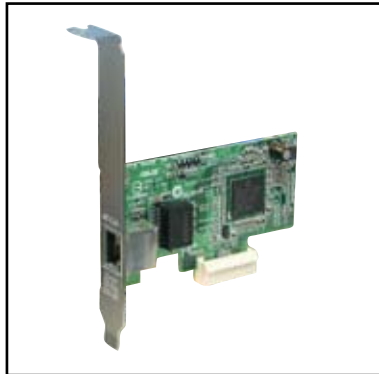

1.8.6 PCI Express x16 slot

This motherboard supports PCI Express x16 graphic cards that comply with the PCI Express specifications. The figure shows a graphics card installed on the PCI Express x16 slot.



1.9 Jumpers

1. Clear RTC RAM (CLRTC)

This jumper allows you to clear the Real Time Clock (RTC) RAM in CMOS. You can clear the CMOS memory of date, time, and system setup parameters by erasing the CMOS RTC RAM data. The onboard button cell battery powers the RAM data in CMOS, which include system setup information such as system passwords.

To erase the RTC RAM:

1. Turn OFF the computer and unplug the power cord.
2. Remove the onboard battery.
3. Move the jumper cap from pins 1-2 (default) to pins 2-3. Keep the cap on pins 2-3 for about 5~10 seconds, then move the cap back to pins 1-2.
4. Re-install the battery.
5. Plug the power cord and turn ON the computer.
6. Hold down the key during the boot process and enter BIOS setup to re-enter data.



Except when clearing the RTC RAM, never remove the cap on CLRTC jumper default position. Removing the cap will cause system boot failure!

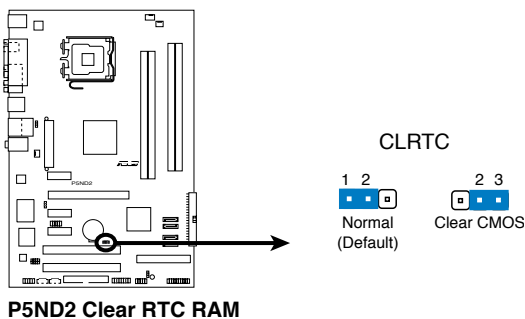

2. USB device wake-up (3-pin USBPW1234, USBPW34, USBPW78)

Set these jumpers to +5V to wake up the computer from S1 sleep mode (CPU stopped, DRAM refreshed, system running in low power mode) using the connected USB devices. Set to +5VSB to wake up from S3 and S4 sleep modes (no power to CPU, DRAM in slow refresh, power supply in reduced power mode).

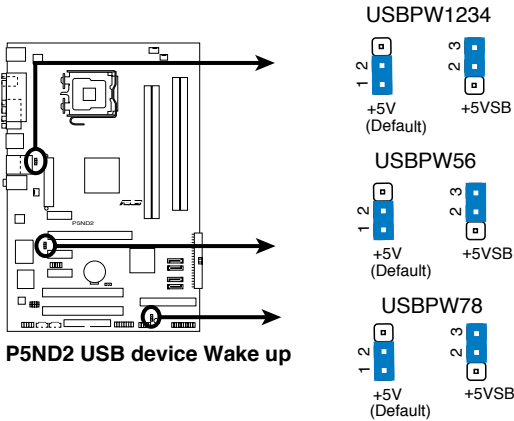

- The USB device wake-up feature requires a power supply that can provide 500mA on the +5VSB lead for each USB port; otherwise, the system would not power up.
- The total current consumed must NOT exceed the power supply capability (+5VSB) whether under normal condition or in sleep mode.

1.10 Connectors

1.10.1 Rear panel connectors

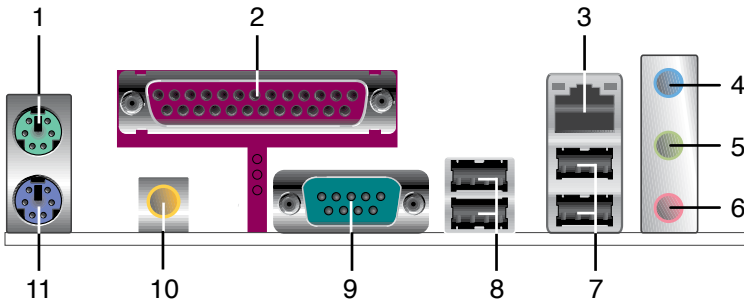

1. **PS/2 mouse port (green).** This port is for a PS/2 mouse.
2. **Parallel port.** This 25-pin port connects a parallel printer, a scanner, or other devices.
3. **LAN (RJ-45) port.** Supported by Marvell® Gigabit LAN controller, this port allows Gigabit connection to a Local Area Network (LAN) through a network hub.

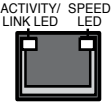

ACTIVITY/ LINK LED SPEED LED

LAN port

Activity/Link LED	Speed LED	Description
OFF	OFF	Soft-off Mode
Orange*	OFF	During Power ON/OFF or 10Mbps connection
Orange*	Orange	100Mbps connection
Orange*	Green	1Gbps connection

* Blinking

4. **Line In port (light blue).** This port connects the tape, CD, DVD player, or other audio sources.
5. **Line Out port (lime).** This port connects a headphone or a speaker. In 4-channel, and 6-channel configuration, the function of this port becomes Front Speaker Out.
6. **Microphone port (pink).** This port connects a microphone.



Refer to the audio configuration table below for the function of the audio ports in 2, 4, or 6-channel configuration.

Audio 2, 4, or 6-channel configuration

Port	Headset 2-channel	4-channel	6-channel
Light Blue	Line In	Rear Speaker Out	Surround
Lime	Line Out	Front Speaker Out	Front Speaker Out
Pink	Mic In	Mic In	Center/Bass

7. **USB 2.0 ports 3 and 4.** These two 4-pin Universal Serial Bus (USB) ports are available for connecting USB 2.0 devices.
8. **USB 2.0 ports 1 and 2.** These two 4-pin Universal Serial Bus (USB) ports are available for connecting USB 2.0 devices.
9. **Serial port.** This port connects a mouse, modem, or other devices that conform with serial specification.
10. **Coaxial S/PDIF Out port.** This port connects an external audio output device via a coaxial S/PDIF cable.
11. **PS/2 keyboard port (purple).** This port is for a PS/2 keyboard.

1.10.2 Internal connectors

1. Floppy disk drive connector (34-1 pin FLOPPY)

This connector is for the provided floppy disk drive (FDD) signal cable. Insert one end of the cable to this connector, then connect the other end to the signal connector at the back of the floppy disk drive.



Pin 5 on the connector is removed to prevent incorrect cable connection when using a FDD cable with a covered Pin 5.

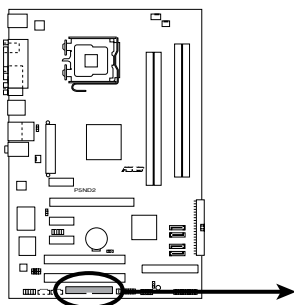

P5ND2 Floppy Disk Drive Connector

FLOPPY



PIN 1

NOTE: Orient the red markings on the floppy ribbon cable to PIN 1.

2. IDE connectors (40-1 pin PRI_IDE, SEC_IDE)

The onboard IDE connectors are for Ultra DMA 133/100/66 signal cables. There are three connectors on each Ultra DMA 133/100/66 signal cable: blue, black, and gray. Connect the blue connector to the motherboard's IDE connector, then select one of the following modes to configure your device(s).

	Drive jumper setting	Mode of device(s)	Cable connector
Single device	Cable-Select or Master	-	Black
Two devices	Cable-Select	Master Slave	Black Gray
	Master Slave	Master Slave	Black or gray



- Pin 20 on the IDE connector is removed to match the covered hole on the Ultra DMA cable connector. This prevents incorrect insertion when you connect the IDE cable.
- Use the 80-conductor IDE cable for Ultra DMA 133/100/66 IDE devices.



If any device jumper is set as “Cable-Select,” make sure all other device jumpers have the same setting.

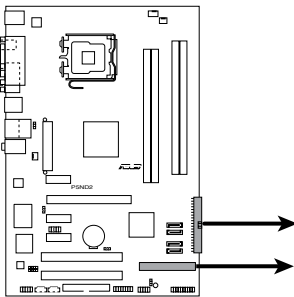

P5ND2 IDE Connectors

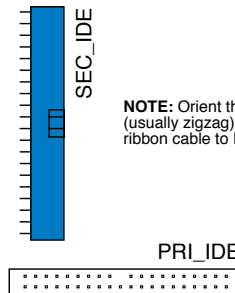

NOTE: Orient the red markings (usually zigzag) on the ID ribbon cable to PIN 1.

3. Serial ATA connectors (7-pin SATA1, SATA2, SATA3, SATA4)

These connectors are for the Serial ATA signal cables for Serial ATA hard disk devices. The current Serial ATA I interface allows up to 150 MB/s data transfer rate while Serial ATA II allows up to 300 MB/s data transfer rate, faster than the standard parallel ATA with 133 MB/s (DMA/133).

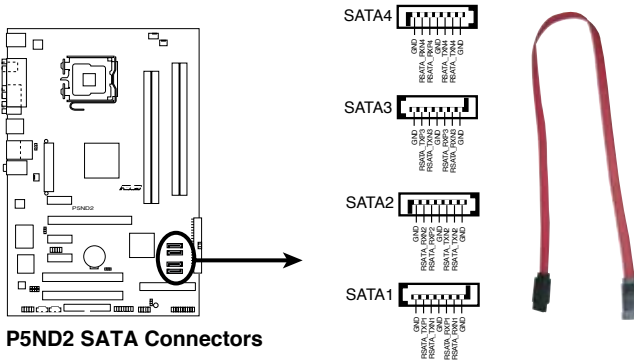

4. Audio connectors (4-pin CD, AUX)

These connectors allow you to receive stereo audio input from sound sources such as a CD-ROM, TV-tuner, or MPEG card.

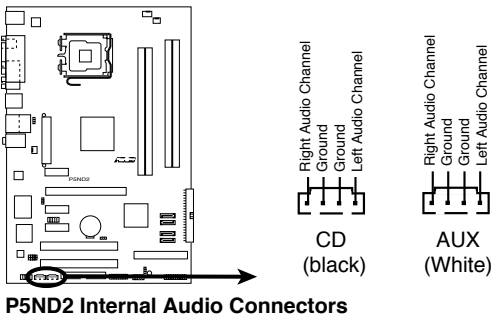

5. USB connectors (10-1 pin USB56, USB78)

These connectors are for USB 2.0 ports. Connect the USB module cable to any of these connectors, then install the module to a slot opening at the back of the system chassis. These USB connectors comply with USB 2.0 specification that supports up to 480 Mbps connection speed.

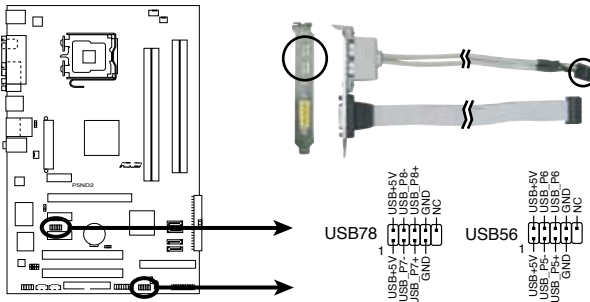

P5ND2 USB2.0 Connectors



Never connect a **1394 cable** to the USB connectors. Doing so will damage the motherboard!



The USB module is purchased separately.

6. GAME/MIDI port connector (16-1 pin GAME)

This connector is for a GAME/MIDI port. Connect the USB/GAME module cable to this connector, then install the module to a slot opening at the back of the system chassis. The GAME/MIDI port connects a joystick or game pad for playing games, and MIDI devices for playing or editing audio files.

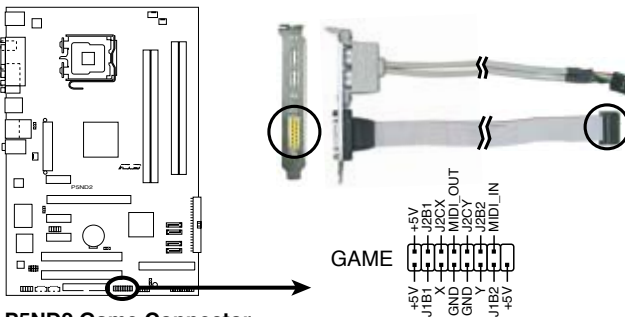

P5ND2 Game Connector



The GAME module is purchased separately.

7. Azalia Analog Front Panel (10-1 pin AAFP)

This connector is for a chassis-mounted front panel audio I/O module that supports legacy AC '97 audio standard. Connect one end of the front panel audio I/O module cable to this connector.

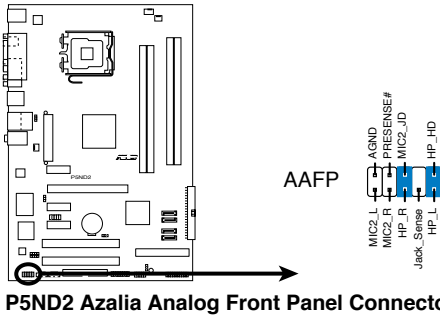

8. CPU, Power and Chassis Fan connectors (4-pin CPU_FAN, 3-pin PWR_FAN, 3-pin CHA_FAN)

The fan connectors support cooling fans of 350 mA ~ 2000 mA (24 W max.) or a total of 1 A ~ 3.48 A (41.76 W max.) at +12V. Connect the fan cables to the fan connectors on the motherboard, making sure that the black wire of each cable matches the ground pin of the connector.



Do not forget to connect the fan cables to the fan connectors. Insufficient air flow inside the system may damage the motherboard components. These are not jumpers! Do not place jumper caps on the fan connectors!

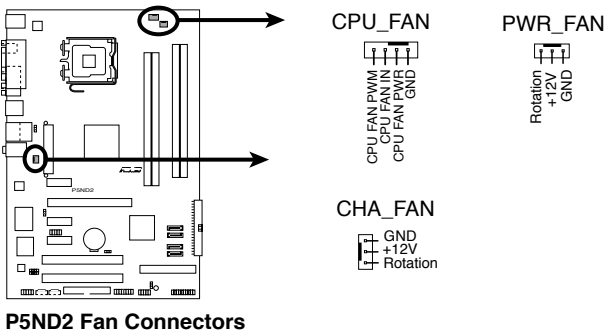

9. Chassis intrusion connector (4-1 pin CHASSIS)

This connector is for a chassis-mounted intrusion detection sensor or switch. Connect one end of the chassis intrusion sensor or switch cable to this connector. The chassis intrusion sensor or switch sends a high-level signal to this connector when a chassis component is removed or replaced. The signal is then generated as a chassis intrusion event.

By default, the pins labeled “Chassis Signal” and “Ground” are shorted with a jumper cap. Remove the jumper caps only when you intend to use the chassis intrusion detection feature.

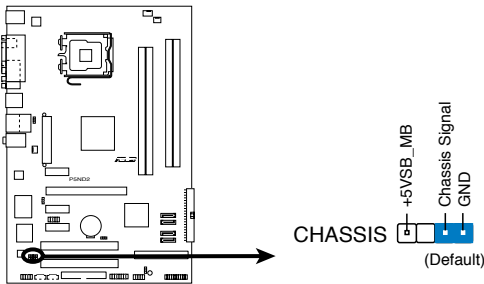

P5ND2 Chassis Intrusion Connector

10. Digital audio connector (4-1 pin SPDIF_OUT)

This connector is for an additional Sony/Philips Digital Interface (S/PDIF) port(s). Connect the S/PDIF module cable to this connector, then install the module to a slot opening at the back of the system chassis.



The S/PDIF module is purchased separately.

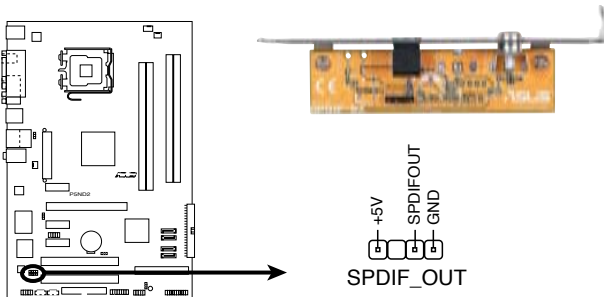

P5ND2 Digital Audio Connector

11. ATX power connectors (24-pin EATXPWR, 4-pin ATX12V)

These connectors are for ATX power supply plugs. The power supply plugs are designed to fit these connectors in only one orientation. Find the proper orientation and push down firmly until the connectors completely fit.

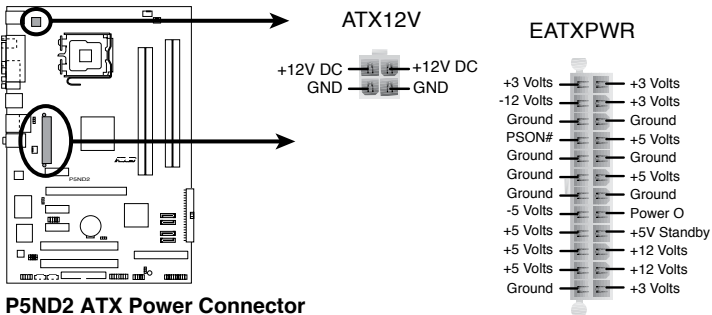

- For a fully configured system, we recommend that you use a power supply unit (PSU) that complies with ATX 12 V Specification 2.0 (or later version) and provides a minimum power of 400 W.
- Do not forget to connect the 4-pin ATX +12 V power plug; otherwise, the system will not boot.
- Use of a PSU with a higher power output is recommended when configuring a system with more power-consuming devices. The system may become unstable or may not boot up if the power is inadequate.

12. System panel connector (20-pin PANEL)

This connector supports several chassis-mounted functions.

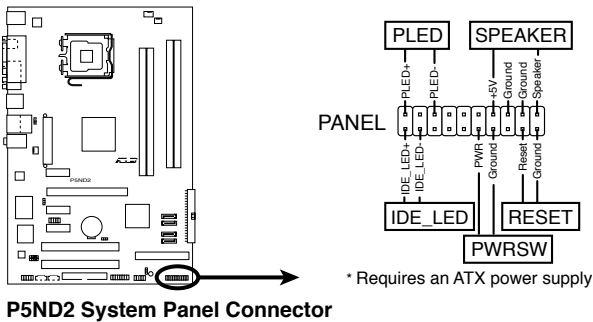

The system panel connector is color-coded for easy connection. Refer to the connector description below for details.

- **System power LED (Green 2-pin PLED)**
This 3-pin connector is for the system power LED. Connect the chassis power LED cable to this connector. The system power LED lights up when you turn on the system power, and blinks when the system is in sleep mode.
- **Hard disk drive activity LED (Red 2-pin IDE_LED)**
This 2-pin connector is for the HDD Activity LED. Connect the HDD Activity LED cable to this connector. The IDE LED lights up or flashes when data is read from or written to the HDD.
- **System warning speaker (Orange 2-pin SPEAKER)**
This 4-pin connector is for the chassis-mounted system warning speaker. The speaker allows you to hear system beeps and warnings.
- **ATX power button/soft-off button (Light Green 2-pin PWRSW)**
This connector is for the system power button. Pressing the power button turns the system on or puts the system in sleep or soft-off mode depending on the BIOS settings. Pressing the power switch for more than four seconds while the system is ON turns the system OFF.
- **Reset button (Blue 2-pin RESET)**
This 2-pin connector is for the chassis-mounted reset button for system reboot without turning off the system power.

This chapter tells how to change the system settings through the BIOS Setup menus. Detailed descriptions of the BIOS parameters are also provided.

BIOS setup **2**

2.1 Managing and updating your BIOS

The following utilities allow you to manage and update the motherboard Basic Input/Output System (BIOS) setup.

1. **Award BIOS Flash Utility** (Updates the BIOS in DOS mode using a bootable floppy disk.)
2. **ASUS CrashFree BIOS 2** (Updates the BIOS using a bootable floppy disk or the motherboard support CD when the BIOS file fails or gets corrupted.)
3. **ASUS EZ Flash** (Updates the BIOS in DOS using a floppy disk or the motherboard support CD.)
4. **ASUS Update** (Updates the BIOS in Windows® environment.)

Refer to the corresponding sections for details on these utilities.



Save a copy of the original motherboard BIOS file to a bootable floppy disk in case you need to restore the BIOS in the future. Copy the original motherboard BIOS using the ASUS Update or AwardBIOS Flash utilities.

2.1.1 Creating a bootable floppy disk

1. Do either one of the following to create a bootable floppy disk.

DOS environment

- a. Insert a 1.44MB floppy disk into the drive.
- b. At the DOS prompt, type `format a: /s` then press <Enter>.

Windows® XP environment

- a. Insert a 1.44 MB floppy disk to the floppy disk drive.
- b. Click **Start** from the Windows® desktop, then select **My Computer**.
- c. Select the 3 1/2 Floppy Drive icon.
- d. Click **File** from the menu, then select **Format. A Format 3 1/2 Floppy Disk** window appears.
- e. Select **Create an MS-DOS startup disk** from the format options field, then click Start.

Windows® 2000 environment

To create a set of boot disks for Windows® 2000:

- a. Insert a formatted, high density 1.44 MB floppy disk into the drive.
- b. Insert the Windows® 2000 CD to the optical drive.

- c. Click **Start**, then select **Run**.
 - d. From the Open field, type
`D:\bootdisk\makeboot a:`
 assuming that D: is your optical drive.
 - e. Press <Enter>, then follow screen instructions to continue.
2. Copy the original or the latest motherboard BIOS file to the bootable floppy disk.

2.1.2 Updating the BIOS

The Basic Input/Output System (BIOS) can be updated using the AwardBIOS Flash Utility. Follow these instructions to update the BIOS using this utility.

1. Download the latest BIOS file from the ASUS web site. Rename the file to **P5ND2.BIN** and save it to a floppy disk.



Save only the updated BIOS file in the floppy disk to avoid loading the wrong BIOS file.

2. Copy the AwardBIOS Flash Utility (awdfash.exe) from the Software folder of the support CD to the floppy disk with the latest BIOS file.
3. Boot the system in DOS mode using the bootable floppy disk you created earlier.
4. When the **A:>** appears, replace the bootable floppy disk with the floppy disk containing the new BIOS file and the Award BIOS Flash Utility.
5. At the prompt, type **awdfash** then press <Enter>. The Award BIOS Flash Utility screen appears.

```

AwardBIOS Flash Utility for ASUS V1.08
(C) Phoenix Technologies Ltd. All Rights Reserved

For nForce ultra-P5ND2-00      DATE: 04/10/2006
Flash Type - SST 49LF004A/B /3.3V

File Name to Program: 

Message: Please input File Name!
  
```

6. Type the BIOS file name in the **File Name to Program** field, then press <Enter>.

```
AwardBIOS Flash Utility for ASUS V1.08
(C) Phoenix Technologies Ltd. All Rights Reserved

For nForce_ultra-P5ND2-00    DATE: 04/10/2006
Flash Type - SST 49LF004A/B /3.3V

File Name to Program: P5NSLI.bin

Message: Do You Want To Save Bios (Y/N)
```

7. Press <N> when the utility prompts you to save the current BIOS file. The following screen appears.
8. The utility verifies the BIOS file in the floppy disk and starts flashing the BIOS file.

```
AwardBIOS Flash Utility for ASUS V1.08
(C) Phoenix Technologies Ltd. All Rights Reserved

For nForce_ultra-P5ND2-00    DATE: 04/10/2006
Flash Type - SST 49LF004A/B /3.3V

File Name to Program: P5NSLI.bin

Program Flashing Memory - OFE00 OK

Write OK      No Update      Write Fail

Warning: Don't Turn Off Power Or Reset System!
```



Do not turn off or reset the system during the flashing process!

9. The utility displays a **Flashing Complete** message indicating that you have successfully flashed the BIOS file. Remove the floppy disk then press <F1> to restart the system.

```
AwardBIOS Flash Utility for ASUS V1.08
(C) Phoenix Technologies Ltd. All Rights Reserved

For nForce_ultra-P5ND2-00    DATE: 04/10/2006
Flash Type - SST 49LF004A/B /3.3V

File Name to Program: P5NSLI.bin

Flashing Complete
Press <F1> to Continue

Write OK      No Update      Write Fail

F1 Reset
```

2.1.3 Saving the current BIOS file

You can use the AwardBIOS Flash Utility to save the current BIOS file. You can load the current BIOS file when the BIOS file gets corrupted during the flashing process.



Make sure that the floppy disk has enough disk space to save the file.

To save the current BIOS file using the AwardBIOS Flash Utility:

1. Follow steps 1 to 6 of the previous section.
2. Press <Y> when the utility prompts you to save the current BIOS file. The following screen appears.

```
AwardBIOS Flash Utility for ASUS V1.08
(C) Phoenix Technologies Ltd. All Rights Reserved

For nForce_ultra-P5ND2-00      DATE: 04/10/2006
Flash Type - SST 49LF004A/B /3.3V

File Name to Program: 1001.bin
Save current BIOS as:

Message:
```

3. Type a filename for the current BIOS file in the **Save current BIOS as** field, then press <Enter>.

```
AwardBIOS Flash Utility for ASUS V1.08
(C) Phoenix Technologies Ltd. All Rights Reserved

For nForce_ultra-P5ND2-00      DATE: 04/10/2006
Flash Type - SST 49LF004A/B /3.3V

File Name to Program: 1001.bin
Checksum: DAD6H
Save current BIOS as: old.bin

Message: Please Wait!
```

4. The utility saves the current BIOS file to the floppy disk, then returns to the BIOS flashing process.

```
AwardBIOS Flash Utility for ASUS V1.08
(C) Phoenix Technologies Ltd. All Rights Reserved

For nForce_ultra-P5ND2-00      DATE: 04/10/2006
Flash Type - SST 49LF004A/B /3.3V

File Name to Program: 1001.bin
Now Backup System BIOS to
File!

Message: Please Wait!
```

2.1.4 ASUS CrashFree BIOS 2 utility

The ASUS CrashFree BIOS 2 is an auto recovery tool that allows you to restore the BIOS file when it fails or gets corrupted during the updating process. You can update a corrupted BIOS file using the motherboard support CD or the floppy disk that contains the updated BIOS file.



Prepare the motherboard support CD or the floppy disk containing the updated motherboard BIOS before using this utility.

Recovering the BIOS from the support CD

To recover the BIOS from the support CD:

1. Turn on the system.
2. Insert the motherboard support CD to the optical drive.
3. The utility displays the following message and automatically checks the CD for the BIOS file.

```
Award BootBlock BIOS v1.0
Copyright (c) 2000, Award Software, Inc.

BIOS ROM checksum error
Detecting IDE ATAPI device...
```

When found, the utility reads the BIOS file and starts flashing the corrupted BIOS file.

```
Award BootBlock BIOS v1.0
Copyright (c) 2000, Award Software, Inc.

BIOS ROM checksum error
Detecting IDE ATAPI device...
Found CDROM, try to Boot from it... Pass
```



DO NOT shut down or reset the system while updating the BIOS! Doing so can cause system boot failure!

4. Restart the system after the utility completes the updating process.

Recovering the BIOS from a floppy disk

To recover the BIOS from the floppy disk:

1. Remove any CD from the optical drive, then turn on the system.
2. Insert the floppy disk with the original or updated BIOS file to the floppy disk drive.
3. The utility displays the following message and automatically checks the optical drive for the original or updated BIOS file.

```
Award BootBlock BIOS v1.0
Copyright (c) 2000, Award Software, Inc.

BIOS ROM checksum error
Detecting IDE ATAPI device...
```

When no CD is found, the utility automatically checks the floppy disk for the original or updated BIOS file. The utility then updates the corrupted BIOS file.

```
Award BootBlock BIOS v1.0
Copyright (c) 2000, Award Software, Inc.

BIOS ROM checksum error
Detecting IDE ATAPI device...
  Found CDROM, try to Boot from it.. Fail

Detecting floppy drive A media...
```



DO NOT shut down or reset the system while updating the BIOS! Doing so can cause system boot failure!

4. Restart the system after the utility completes the updating process.



The recovered BIOS may not be the latest BIOS version for this motherboard. Visit the ASUS website (www.asus.com) to download the latest BIOS file.

2.1.5 ASUS EZ Flash utility

The ASUS EZ Flash feature allows you to update the BIOS without having to go through the long process of booting from a floppy disk and using a DOS-based utility. The EZ Flash utility is built-in the BIOS chip so it is accessible by pressing <Alt> + <F2> during the Power-On Self-Test (POST).

To update the BIOS using EZ Flash:

1. Visit the ASUS website (www.asus.com) to download the latest BIOS file for the motherboard.
2. Save the BIOS file to a floppy disk, then restart the system.
3. Press <Alt> + <F2> during POST to display the following.

Insert Disk then press Enter or ESC to continue POST

4. Insert the floppy disk that contains the BIOS file to the floppy disk drive then press <Enter>. The following screen appears.

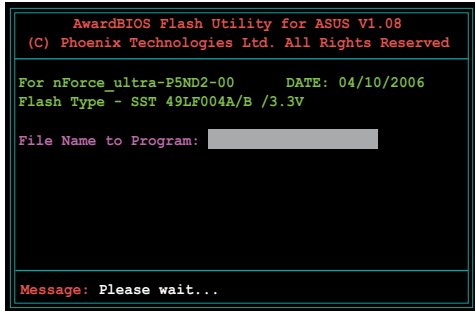

```
AwardBIOS Flash Utility for ASUS v1.08
(C) Phoenix Technologies Ltd. All Rights Reserved

For nForce ultra-P5ND2-00    DATE: 04/10/2006
Flash Type - SST 49LF004A/B /3.3V

File Name to Program: _____

Message: Please wait...
```

5. When the correct BIOS file is found, EZ Flash performs the BIOS update process and automatically reboots the system when done.



Do not shutdown or reset the system while updating the BIOS to prevent system boot failure!

2.1.6 ASUS Update utility

The ASUS Update is a utility that allows you to manage, save, and update the motherboard BIOS in Windows® environment. The ASUS Update utility allows you to:

- Save the current BIOS file
- Download the latest BIOS file from the Internet
- Update the BIOS from an updated BIOS file
- Update the BIOS directly from the Internet, and
- View the BIOS version information.

This utility is available in the support CD that comes with the motherboard package.



ASUS Update requires an Internet connection either through a network or an Internet Service Provider (ISP).

Installing ASUS Update

To install ASUS Update:

1. Place the support CD in the optical drive. The Drivers menu appears.
2. Click the Utilities tab, then click Install ASUS Update VX.XX.XX. See page 3-4 for the Utilities screen menu.
3. The ASUS Update utility is copied to your system.



Quit all Windows® applications before you update the BIOS using this utility.

Updating the BIOS through the Internet

To update the BIOS through the Internet:

1. Launch the ASUS Update utility from the Windows® desktop by clicking **Start > Programs > ASUS > ASUSUpdate > ASUSUpdate**. The ASUS Update main window appears.



2. Select **Update BIOS from the Internet** option from the drop-down menu, then click Next.
3. Select the ASUS FTP site nearest you to avoid network traffic, or click **Auto Select**. Click **Next**.

- From the FTP site, select the BIOS version that you wish to download. Click Next.
- Follow the screen instructions to complete the update process.



The ASUS Update utility is capable of updating itself through the Internet. Always update the utility to avail all its features.



Updating the BIOS through a BIOS file

To update the BIOS through a BIOS file:

- Launch the ASUS Update utility from the Windows® desktop by clicking **Start > Programs > ASUS > ASUSUpdate > ASUSUpdate**. The ASUS Update main window appears.
- Select **Update BIOS from a file** option from the drop-down menu, then click **Next**.



- Locate the BIOS file from the **Open** window, then click **Open**.
- Follow the screen instructions to complete the update process.

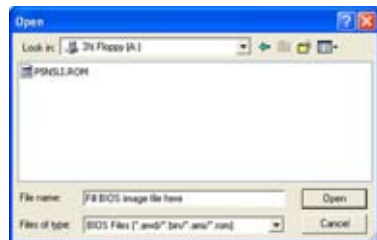

2.2 BIOS setup program

This motherboard supports a programmable Low-Pin Count (LPC) chip that you can update using the provided utility described in section “4.1 Managing and updating your BIOS.”

Use the BIOS Setup program when you are installing a motherboard, reconfiguring your system, or prompted to “Run Setup”. This section explains how to configure your system using this utility.

Even if you are not prompted to use the Setup program, you can change the configuration of your computer in the future. For example, you can enable the security password feature or change the power management settings. This requires you to reconfigure your system using the BIOS Setup program so that the computer can recognize these changes and record them in the CMOS RAM of the LPC chip.

The LPC chip on the motherboard stores the Setup utility. When you start up the computer, the system provides you with the opportunity to run this program. Press during the Power-On Self-Test (POST) to enter the Setup utility; otherwise, POST continues with its test routines.

If you wish to enter Setup after POST, restart the system by pressing <Ctrl>+<Alt>+, or by pressing the reset button on the system chassis. You can also restart by turning the system off and then back on. Do this last option only if the first two failed.

The Setup program is designed to make it as easy to use as possible. Being a menu-driven program, it lets you scroll through the various sub-menus and make your selections from the available options using the navigation keys.



-
- The default BIOS settings for this motherboard apply for most conditions to ensure optimum performance. If the system becomes unstable after changing any BIOS settings, load the default settings to ensure system compatibility and stability. Select the Load Default Settings item under the Exit Menu. See section “2.7 Exit Menu.”
 - The BIOS setup screens shown in this section are for reference purposes only, and may not exactly match what you see on your screen.
 - Visit the ASUS website (www.asus.com) to download the latest BIOS file for this motherboard.
-

2.2.1 BIOS menu screen

Menu items Menu bar Configuration fields General help

```
Phoenix-Award BIOS CMOS Setup Utility
Main  Advanced  Power  Boot  Exit
-----
System Time      [F5] : 30 : 36
System Date     Mon, Feb 6 2006

Legacy Diskette A: [1.44M, 3.5 in.]

▶ Primary IDE Master [ST321122A]
▶ Primary IDE Slave  [ASUS CDS520/A]
▶ Secondary IDE Master [None]
▶ Secondary IDE Slave [None]
▶ First SATA Master   [None]
▶ Second SATA Master  [None]
▶ Third SATA Master   [None]
▶ Fourth SATA Master  [None]
HDD SMART Monitoring [Disabled]

Installed Memory  256MB
Usable Memory     256MB

Select Menu
Item Specific Help▶
Change the day, month,
year and century.

F1: Help      ↑↓: Select Item  -/+ : Change Value  F5: Setup Defaults
ESC: Exit    →←: Select Menu  Enter: Select Sub-menu  F10: Save and Exit
```

Sub-menu items Legend bar

2.2.2 Menu bar

The menu bar on top of the screen has the following main items:

- Main** For changing the basic system configuration
- Advanced** For changing the advanced system settings
- Power** For changing the advanced power management (APM) configuration
- Boot** For changing the system boot configuration
- Exit** For selecting the exit options and loading default settings

To select an item on the menu bar, press the right or left arrow key on the keyboard until the desired item is highlighted.



- The BIOS setup screens shown in this chapter are for reference purposes only, and may not exactly match what you see on your screen.
- Visit the ASUS website (www.asus.com) to download the latest BIOS information.

2.2.3 Legend bar

At the bottom of the Setup screen is a legend bar. The keys in the legend bar allow you to navigate through the various setup menus. The following table lists the keys found in the legend bar with their corresponding functions.

Navigation Key	Function
<F1>	Displays the General Help screen
<F5>	Loads setup default values
<Esc>	Exits the BIOS setup or returns to the main menu from a sub-menu
Left or Right arrow	Selects the menu item to the left or right
Up or Down arrow	Moves the highlight up or down between fields
Page Down or - (minus)	Scrolls backward through the values for the highlighted field
Page Up or + (plus)	Scrolls forward through the values for the highlighted field
<Enter>	Brings up a selection menu for the highlighted field
<F10>	Saves changes and exit

2.2.4 Menu items

The highlighted item on the menu bar displays the specific items for that menu. For example, selecting Main shows the **Main** menu items.

The other items (Advanced, Power, Boot, and Exit) on the menu bar have their respective menu items.

2.2.5 Sub-menu items

A solid triangle before each item on any menu screen means that the item has a sub-menu. To display the sub-menu, select the item and press <Enter>.

2.2.6 Configuration fields

These fields show the values for the menu items. If an item is user-configurable, you can change the value of the field opposite the item. You cannot select an item that is not user-configurable.

A configurable field is enclosed in brackets, and is highlighted when selected. To change the value of a field, select it then press <Enter> to display a list of options. Refer to “2.2.7 Pop-up window.”

2.2.7 Pop-up window

Select a menu item then press <Enter> to display a pop-up window with the configuration options for that item.

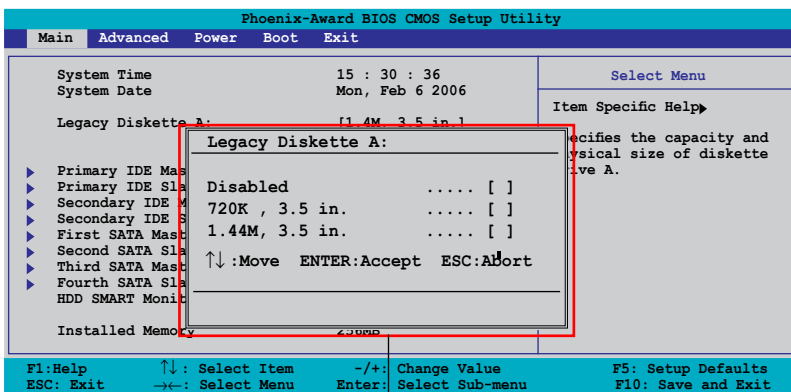

Pop-up menu

2.2.8 General help

At the top right corner of the menu screen is a brief description of the selected item.

2.3 Main menu

When you enter the BIOS Setup program, the Main menu screen appears, giving you an overview of the basic system information.



Refer to section “2.2.1 BIOS menu screen” for information on the menu screen items and how to navigate through them.

Phoenix-Award BIOS CMOS Setup Utility				
Main	Advanced	Power	Boot	Exit
System Time				F5 : 30 : 36
System Date				Mon, Feb 6 2006
Legacy Diskette A:				[1.44M, 3.5 in.]
▶ Primary IDE Master				[ST321122A]
▶ Primary IDE Slave				[ASUS CDS520/A]
▶ Secondary IDE Master				[None]
▶ Secondary IDE Slave				[None]
▶ First SATA Master				[None]
▶ Second SATA Master				[None]
▶ Third SATA Master				[None]
▶ Fourth SATA Master				[None]
HDD SMART Monitoring				[Disabled]
Installed Memory				256MB
Usable Memory				256MB
				Select Menu
				Item Specific Help▶
				Change the day, month, year and century.
F1:Help	↑↓: Select Item	~/+: Change Value	F5: Setup Defaults	
ESC: Exit	→←: Select Menu	Enter: Select Sub-menu	F10: Save and Exit	

2.3.1 System Time [xx:xx:xxxx]

Allows you to set the system time.

2.3.2 System Date [Day xx/xx/xxxx]

Allows you to set the system date.

2.3.3 Legacy Diskette A [1.44M, 3.5 in.]

Sets the type of floppy drive installed. Configuration options: [Disabled]
[720K , 3.5 in.] [1.44M, 3.5 in.]

2.3.4 Primary and Secondary IDE Master/Slave

While entering Setup, the BIOS automatically detects the presence of IDE devices. There is a separate sub-menu for each IDE device. Select a device item then press <Enter> to display the IDE device information.

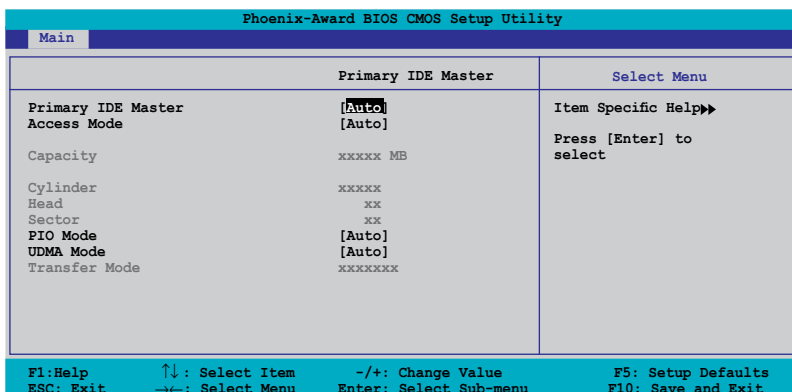

The BIOS automatically detects the values opposite the dimmed items (Capacity, Cylinder, Head, Sector and Transfer Mode). These values are not user-configurable. These items show N/A if no IDE device is installed in the system.

Primary IDE Master/Slave [Auto]; Secondary IDE Master/Slave [Auto]

Select [Auto] to automatically detect an IDE hard disk drive. If automatic detection is successful, the BIOS automatically fills in the correct values for the remaining fields on this sub-menu. If the hard disk was already formatted on a previous system, the setup BIOS may detect incorrect parameters. Select [Manual] to manually enter the IDE hard disk drive parameters. If no drive is installed select [None].

Configuration options: [None] [Auto] [Manual]

Access Mode [Auto]

The default [Auto] allows automatic detection of an IDE hard disk drive. Select [CHS] for this item if you set the IDE Primary Master/Slave to [Manual]. Configuration options: [CHS] [LBA] [Large] [Auto]



Before attempting to configure a hard disk drive, make sure you have the correct configuration information supplied by the drive manufacturer. Incorrect settings may cause the system to fail to recognize the installed hard disk.

Capacity

Displays the auto-detected hard disk capacity. This item is not configurable.

Cylinder

Shows the number of the hard disk cylinders. This item is not configurable.

Head

Shows the number of the hard disk read/write heads. This item is not configurable.

Sector

Shows the number of sectors per track. This item is not configurable.

PIO Mode [Auto]

Sets the PIO mode for the IDE device.

Configuration options: [Auto] [Mode 0] [Mode 1] [Mode 2] [Mode 3] [Mode 4]

UDMA Mode [Auto]

Disables or sets the UDMA mode. Configuration options: [Disable] [Auto]

Transfer Mode

Shows the Transfer mode. This item is not configurable.



After entering the IDE hard disk drive information into BIOS, use a disk utility, such as FDISK, to partition and format new IDE hard disk drives. This is necessary so that you can write or read data from the hard disk. Make sure to set the partition of the Primary IDE hard disk drives to active.

2.3.5 First, Second, Third, Fourth SATA Master

While entering Setup, the BIOS automatically detects the presence of Serial ATA devices. There is a separate sub-menu for each SATA device. Select a device item then press <Enter> to display the SATA device information.

Phoenix-Award BIOS CMOS Setup Utility		
Main		
	Primary IDE Master	Select Menu
Extended IDE Drive Access Mode	[Auto] [Auto]	Item Specific Help▶▶ Press [Enter] to select
Capacity	xxxxxx MB	
Cylinder	xxxxxx	
Head	xx	
Precomp	xx	
Landing Zone	xx	
Sector	xx	

F1: Help ↑↓: Select Item -/+: Change Value F5: Setup Defaults
ESC: Exit →←: Select Menu Enter: Select Sub-menu F10: Save and Exit

The BIOS automatically detects the values opposite the dimmed items (Capacity, Cylinder, Head, Precomp, Landing Zone and Sector). These values are not user-configurable. These items show 0 if no SATA device is installed in the system.

Extended IDE Drive [Auto]

Selects the type of fixed disk connected to the system.
Configuration options: [None] [Auto]

Access Mode [Auto]

Sets the sector addressing mode. Configuration options: [Large] [Auto]



Before attempting to configure a hard disk drive, make sure you have the correct configuration information supplied by the drive manufacturer. Incorrect settings may cause the system to fail to recognize the installed hard disk.

Capacity

Displays the auto-detected hard disk capacity. This item is not configurable.

Cylinder

Shows the number of the hard disk cylinders. This item is not configurable.

Head

Shows the number of the hard disk read/write heads. This item is not configurable.

Precomp

Shows the number of precomp per track. This item is not configurable.

Landing Zone

Shows the number of landing zone per track. This item is not configurable.

Sector

Shows the number of sectors per track. This item is not configurable.



After entering the IDE hard disk drive information into BIOS, use a disk utility, such as FDISK, to partition and format new IDE hard disk drives. This is necessary so that you can write or read data from the hard disk. Make sure to set the partition of the Primary IDE hard disk drives to active.

2.3.6 HDD SMART Monitoring [Disabled]

Allows you to enable or disable the HDD Self-Monitoring Analysis and Reporting Technology (SMART) feature.

Configuration options: [Disabled] [Enabled]

2.3.7 Installed Memory

Shows the size of installed memory.

2.3.8 Usable Memory

Shows the size of usable memory.

2.4 Advanced menu

The Advanced menu items allow you to change the settings for the CPU and other system devices.



Take caution when changing the settings of the Advanced menu items. Incorrect field values can cause the system to malfunction.

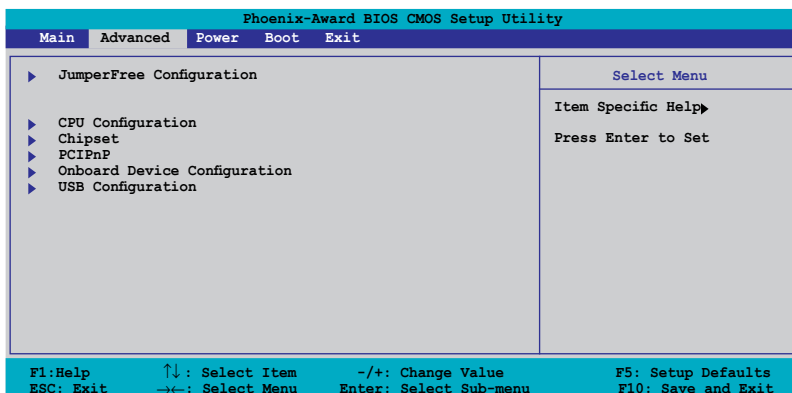

2.4.1 JumperFree Configuration

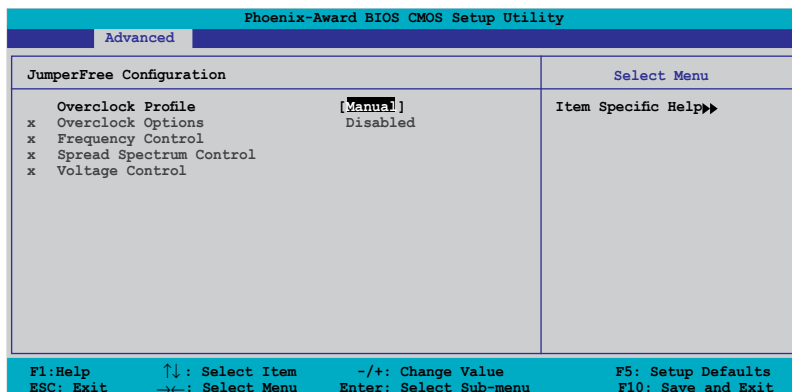

Overclock Profile [Manual]

Allows selection of CPU overclocking options to achieve desired CPU internal frequency. Select either one of the preset overclocking configuration options:

Manual	Allows you to individually set overclocking parameters.
Auto	Loads the optimal settings for the system.
Standard	Loads the standard settings for the system.
AI Overclock	Loads overclocking profiles with optimal parameters for stability when overclocking.
Safe Mode	Loads the safest configuration for your system.

Overclock Options [Disable]

Allows you to disable or set the oveclocking options.

Configuration options: [Disabled] [Overclock 5%] [Overclock 10%]
 [Overclock 15%] [Overclock 20%] [FSB 960/800] [FSB 1280/800]
 [FSB 1000/667] [FSB 1333/667] [FSB 1200/800]



The Overclock Options item is user-configurable only when the Overclock Profile is set to [AI Overclock].

Frequency Control

This sub-menu allows you to set CPU, PCI Express, and memory related fields. Set the Overclock Profile to Manual, if you want to configure this item.

Phoenix-Award BIOS CMOS Setup Utility		
Advanced		
Frequency Control		Select Menu
PCIE Frequency (MHz)	[100]	Item Specific Help▶▶
System Clock Mode	[CPU Precision Tweaker]	Press [Enter] to Set.
New FSB Speed (QDR)	[800]	
Current FSB Speed (QDR)	800.0 MHz	
Target FSB Speed (QDR)	800.0 MHz	
x New MEM Speed (DDR)	Link	
Current MEM Speed (DDR)	533.3 MHz	
Target MEM Speed (DDR)	533.3 MHz	
F1: Help	↑↓: Select Item	-/+ : Change Value
ESC: Exit	→←: Select Menu	Enter: Select Sub-menu
		F5: Setup Defaults
		F10: Save and Exit

PCIE Frequency [100]

Allows you to set the PCI Express frequency. Key-in a decimal value between 100-150 MHz.

Configuration options: [100MHz] [101MHz] ~ [150MHz]



Selecting a very high PCIE frequency may cause the system to become unstable! If this happens, revert to the default setting.

System Clock Mode [CPU Precision Tweaker]

Sets the system clock mode. The default setting [Auto], automatically sets the FSB and memory speeds. Set to [CPU Precision Tweaker] if you want to set the FSB at 1MHz increment with the memory frequency adjusting accordingly, setting to [CPU/MEM manual-mode] allows you to manually input the CPU and memory frequency. When set to [MEM Precision Tweaker], you can manually set the memory frequency.

Configuration options: [Auto] [CPU Precision Tweaker] [CPU/MEM manual-mode] [MEM Precision Tweaker]

New FSB Speed (QDR) [800]

Allows you to key-in new FSB speed. The configuration options vary depending on the CPU installed.



The New FSB Speed (QDR) item is user-configurable only when the System Clock Mode is set to [CPU Precision Tweaker] or [CPU/MEM manual-mode].

Current FSB Speed (QDR)

Displays the current FSB speed.

Target FSB Speed (QDR)

Displays the target FSB speed.

New MEM Speed (DDR)

Allows you to key-in new memory speed. The configuration options vary depending on the DDR2 memory installed.



The New MEM Speed (QDR) item is user-configurable only when the System Clock Mode is set to [MEM Precision Tweaker] or [CPU/MEM manual-mode].

Current MEM Speed (QDR)

Displays the current MEM speed.

Target MEM Speed (QDR)

Displays the target MEM speed.

Spread Spectrum Control

This sub-menu allows you to set the CPU, PCI Express, Serial ATA, and Lightning Data Transport (LDT) clock generator spread spectrum. The spread spectrum is used to dynamically change the system frequency to minimize problems with electromagnetic interference (EMI). Set the Overclock Profile to [Manual], if you want to configure this item.

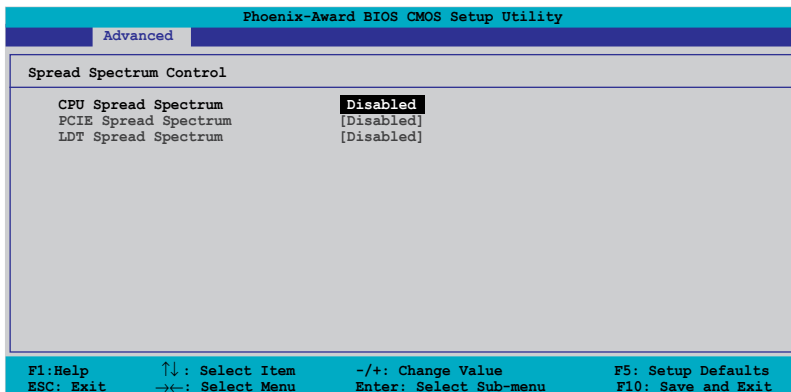

CPU Spread Spectrum [Disabled]

Disables or sets the CPU clock generator spread spectrum. The default setting [Center Spread] allows a dynamic CPU frequency change of -0.25% to +0.25%. The [Down Spread] setting allows a dynamic CPU frequency change of -0.5% to 0.0%. Setting to [0.5%++ Spread] allows dynamic frequency changes from -0.5% to +0.5%.
Configuration options: [Disabled] [Center Spread] [Down Spread] [0.5%++ Spread]

PCIE Spread Spectrum [Disabled]

Disables or sets the PCI Express clock generator spread spectrum. The default setting [Down Spread] allows a dynamic PCI Express frequency change of -0.5% to 0.0%.
Configuration options: [Disabled] [Down Spread]

LDT Spread Spectrum [Disabled]

Disables or sets the Lightning Data Transport (LDT) clock generator spread spectrum. The default setting [Center Spread] allows a dynamic LDT frequency change of -0.25% to +0.25%.
Configuration options: [Disabled] [Center Spread] [Down Spread]

Voltage Control

This sub-menu allows you to set the system operating voltages. Set the Overclock Profile to [Manual], if you want to configure this item.

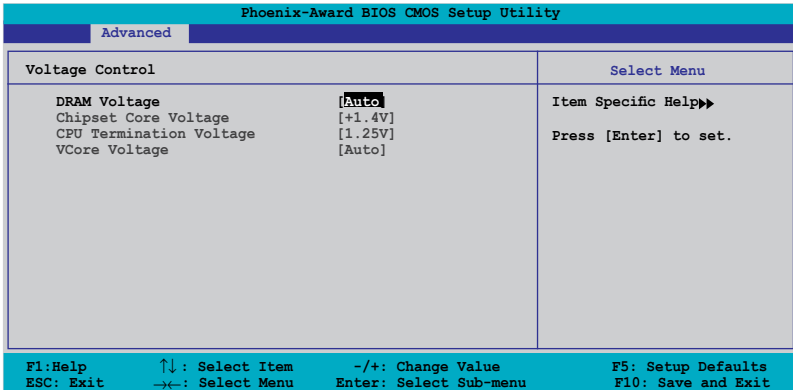

DRAM Voltage [Auto]

Allows you to set the DRAM operating voltage. Set to Auto for safe mode.
Configuration options: [Auto] [+1.800V] [+1.900V] [+2.000V]
[+2.100V]



Refer to the DDR2 documentation before setting the memory voltage.
Setting a very high memory voltage may damage the memory module(s)!

Chipset Core Voltage [+1.4V]

Allows you to set the chipset core voltage.
Configuration options: [+1.4V] [+1.5V]

CPU Termination Voltage [1.25V]

Allows you to set the CPU termination voltage.
Configuration options: [1.25V] [1.30V] [1.35V] [1.40V]

VCore Voltage [Auto]

Sets the operating VCore voltage. Configuration options: [Auto]
[1.6000V] [1.5875V] [1.5750V] [1.5625V] [1.5500V] [1.5375V]
[1.5250V] [1.5125V] [1.5000V] [1.4875V] [1.4750V] [1.4625V]
[1.4500V] [1.4375V] [1.4250V] [1.4125V] [1.4000V] [1.3875V]
[1.3750V] [1.3625V] [1.3500V] [1.3375V] [1.3250V] [1.3125V]
[1.3000V] [1.2875V] [1.2750V] [1.2625V] [1.2500V] [1.2375V]
[1.2250V] [1.2125V] [1.2000V] [1.1875V] [1.1750V] [1.1625V]
[1.1500V] [1.1375V] [1.1250V] [1.1125V] [1.1000V] [1.0875V]
[1.0750V] [1.0625V] [1.0500V] [1.0375V] [1.0250V] [1.0125V]
[1.0000V] [0.9875V] [0.9750V] [0.9625V] [0.9500V] [0.9375V]
[0.9250V] [0.9125V] [0.9000V] [0.8875V] [0.8750V] [0.8625V]
[0.8500V] [0.8375V]

2.4.2 CPU Configuration

Phoenix-Award BIOS CMOS Setup Utility		
Advanced		
CPU Configuration		Select Menu
CPU Type	Intel Pentium(R) 4	Item Specific Help▶▶
CPU Speed	3.80GHz	
Cache RAM	2048K	
CPU Lockfree	[Disabled]	DRAM timing and control
CPU Clock Ratio	[19 X]	
CPU Internal Thermal Control	[Auto]	
X TM2 Bus Ratio	14X	
X TM2 Bus VID	0.8375V	
Limit CPUID MaxVal	[Disabled]	
Enhanced C1 (C1E)	[Auto]	
Execute Disable Bit	[Enabled]	
Enhanced Intel SpeedStep(tm)Tech.	[Auto]	
Hyper-Threading Technology	[Enabled]	

F1: Help ↑↓: Select Item -/+ : Change Value F5: Setup Defaults
ESC: Exit →←: Select Menu Enter: Select Sub-menu F10: Save and Exit

CPU Lockfree [Disabled]

When Disabled, the processor operates with the default multiplier and CPU core frequency. When Enabled, the CPU multiplier is unlocked and the CPU runs at a lower core frequency. This item appears only when you install a processor with the CPU LockFree feature.

Configuration options: [Disabled] [Enabled]

CPU Clock Ratio [19 X]

Allows you to set the CPU clock ratio. Key-in a decimal value between 14-19.

Configuration options: [14] ~ [19]

CPU Internal Thermal Control [Auto]

Enables or disables the CPU Internal Thermal Control feature.
Configurable options: [Auto] [Disabled]

TM2 Bus Ratio, VID

Displays the Thermal Monitor Bus Ratio and Voltage ID.

Limit CPUID MaxVal [Disabled]

Enables or disables the CPU ID maximum value limit.
Configuration options: [Disabled] [Enabled]

Enhanced C1 (C1E) [Auto]

When set to [Auto], the BIOS automatically check the CPU's capability to enable the C1E support. In C1E mode, the CPU power consumption is lower when idle. This item appears only when you install a processor with Enhanced C1E feature.
Configuration options: [Auto] [Disabled]

Excute Disable Bit [Enabled]

When disabled, the processor forces the XD feature flag to always return 0. Configuration options: [Disabled] [Enabled]

Enhanced Intel SpeedStep(tm) Tech. [Auto]

Allows you to use the Enhanced Intel SpeedStep® Technology. When set to [Auto], you can adjust the system power settings in the operation system to use the EIST feature. Set this item to [Disabled] if you do not want to use the EIST.
Configuration options: [Auto] [Disabled]

Hyper-Threading Technology [Enabled]

Enables or disables the Intel® Hyper-Threading Technology feature. This item appears only when you install a Hyper-Treading CPU.
Configuration options: [Disabled] [Enabled]

2.4.3 Chipset

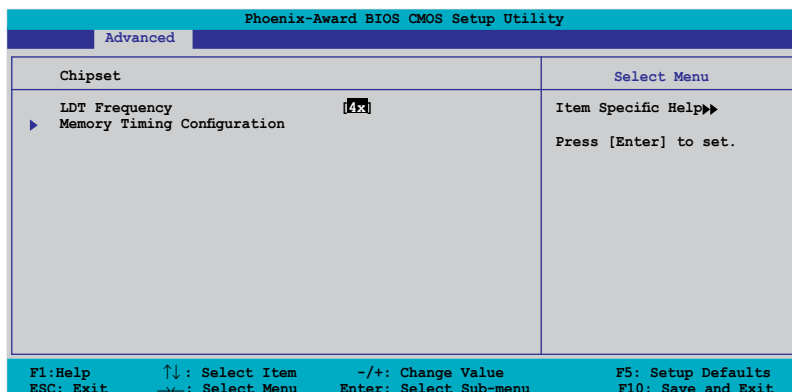

LDT Frequency [4x]

Sets the Lightning Data Transport (LDT) frequency multiplier.
Configuration options: [1x] [2x] [3x] [4x] [5x] [3.5x]

Memory Timing Configuration

This sub-menu allows you to set the memory timing configuration. Set the Overclock Profile to [Manual], if you want to configure this item.

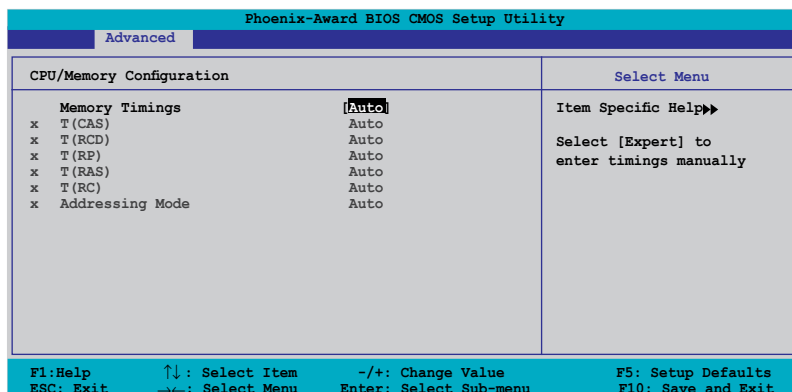

Memory Timings [Auto]

Allows you to set the memory timing parameters. The default setting [Auto], automatically configures the memory timings. Set to [Manual] if you want to input the memory timings manually.

T (CAS) [Auto]

Controls the latency between the SDRAM read command and the time the data actually becomes available.

Configuration options: [Auto] [1] [2] [3] [4] [5] [6]

T (RCD) [Auto]

Sets the RAS-to-CAS delay timing.

Configuration options: [Auto] [1] [2] [3] [4] [5] [6] [7]

T (RP) [Auto]

Sets the row-precharge delay timing.

Configuration options: [Auto] [1] [2] [3] [4] [5] [6] [7]

T (RAS) [Auto]

Sets the row-active delay timing.

Configuration options: [Auto] [1] [2] ~ [31]

T (RC) [Auto]

Sets the row cycle timing.

Configuration options: [Auto] [1] [2] ~ [31]

Addressing Mode [Auto]

Allows you to enable two-clock addressing.

Configuration options: [Auto] [1 clock] [2 clock]

2.4.4 PCIPnP

Phoenix-Award BIOS CMOS Setup Utility	
Advanced	
PCIPnP	Select Menu
Primary Display Adaptor [PCI]	Item Specific Help▶▶
F1: Help ↑↓: Select Item -/+ : Change Value F5: Setup Defaults ESC: Exit →←: Select Menu Enter: Select Sub-menu F10: Save and Exit	

Primary Display Adaptor [PCI]

Allows you to set which graphics controller to use as primary boot device.
Configuration options: [PCI] [PCI-E]

2.4.6 Onboard Devices Configuration

Phoenix-Award BIOS CMOS Setup Utility	
Advanced	
Onboard Device Configuration	Select Menu
▶ IDE Function Setup	Item Specific Help▶▶
▶ NVRAID Configuration	
Onboard Rtl Giga LAN	[Enabled]
Onboard Rtl Giga LAN Boot ROM	[Disabled]
HD Audio	[Enabled]
Serial Port1 Address	[3F8/IRQ4]
Parallel Port Address	[378/IRQ7]
Parallel Port Mode	[ECP+EPP]
ECP Mode Use DMA	[3]
Game Port Address	[201]
Midi Port Address	[330]
Midi Port IRQ	[10]
F1: Help ↑↓: Select Item -/+ : Change Value F5: Setup Defaults ESC: Exit →←: Select Menu Enter: Select Sub-menu F10: Save and Exit	

IDE Function Setup

This sub-menu contains IDE function-related items. Select an item then press <Enter> to edit.

Phoenix-Award BIOS CMOS Setup Utility	
Advanced	
IDE Function Setup	Select Menu
OnChip IDE Channel0	[Enabled]
OnChip IDE Channel1	[Enabled]
IDE DMA transfer access	[Enabled]
SATA Port 1, 2	[Enabled]
SATA DMA transfer	[Enabled]
SATA Port 3, 4	[Enabled]
SATA2 DMA transfer	[Enabled]
IDE Prefetch Mode	[Enabled]
	Item Specific Help▶▶
	Disable/Enable OnChip IDE Channel0

F1: Help ↑↓ : Select Item -/+ : Change Value F5: Setup Defaults
ESC: Exit →← : Select Menu Enter: Select Sub-menu F10: Save and Exit

OnChip IDE Channel0 [Enabled]

Allows you to enable or disable the onchip IDE channel 0 controller .
Configuration options: [Disabled] [Enabled]

OnChip IDE Channel1 [Enabled]

Allows you to enable or disable the onchip IDE channel 1 controller .
Configuration options: [Disabled] [Enabled]

IDE DMA transfer access [Enabled]

Allows you to enable or disable the IDE DMA transfer access.
Configuration options: [Disabled] [Enabled]

SATA Port 1, 2 [Enabled]

Allows you to enable or disable the SATA 1 and 2 ports.
Configuration options: [Disabled] [Enabled]

SATA DMA transfer [Enabled]

Allows you to enable or disable the SATA DMA transfer access.
Configuration options: [Disabled] [Enabled]

SATA Port 3, 4 [Enabled]

Allows you to enable or disable the SATA 3 and 4 ports.
Configuration options: [Disabled] [Enabled]

SATA2 DMA transfer [Enabled]

Allows you to enable or disable the SATA2 DMA transfer access.
Configuration options: [Disabled] [Enabled]

IDE Prefetch Mode [Enabled]

Allows you to enable or disable the IDE prefetch mode.
Configuration options: [Disabled] [Enabled]

NVRAID Configuration

This sub-menu contains NVRAID function-related items. Select an item then press <Enter> to edit.

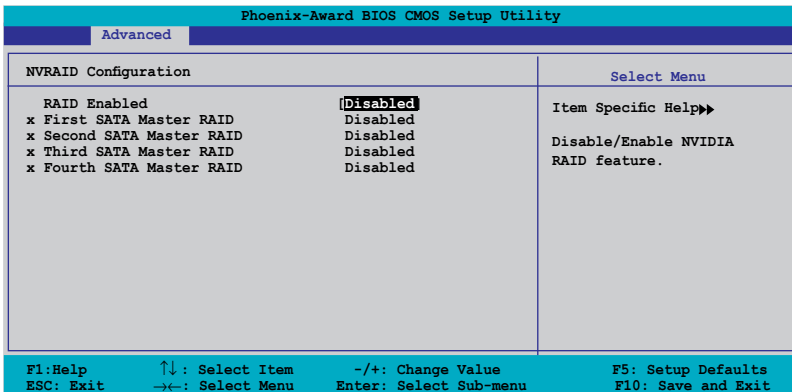

RAID Enabled [Disabled]

Enables or disables the onboard RAID controller. When Enabled, the succeeding items becomes user-configurable.
Configuration options: [Enabled] [Disabled]

First, Second, Third, Fourth SATA Master RAID [Disabled]

Enables or disables the RAID function of the first, second, third or fourth SATA master drive. Configuration options: [Enabled] [Disabled]

Onboard Marvell LAN [Enabled]

Enables or disables the onboard NVIDIA® Gigabit LAN controller.
Configuration options: [Disabled] [Enabled]

OnBoard Marvell LAN Boot ROM [Disabled]

Allows you to enable or disable the onboard NVIDIA® LAN boot ROM.
Configuration options: [Disabled] [Enabled]

HD Audio [Enabled]

Allows you to disable or enabled the onboard HD audio controller.
Configuration options: [Disabled] [Enabled]

Serial Port1 Address [3F8/IRQ4]

Allows you to select the Serial Port1 base address.
Configuration options: [Disabled] [3F8/IRQ4] [2F8/IRQ3] [3E8/IRQ4] [2E8/IRQ3] [Auto]

Parallel Port Address [378/IRQ7]

Allows you to select the Parallel Port base addresses.
Configuration options: [Disabled] [378/IRQ7] [278/IRQ5] [3BC/IRQ7]

Parallel Port Mode [ECP+EPP]

Allows you to select the Parallel Port mode.
Configuration options: [SPP] [EPP] [ECP] [ECP+EPP]

ECP Mode Use DMA [3]

Allows selection of ECP Mode. Configuration options: [1] [3]

Game Port Address [201]

Allows you to select the Game Port address or to disable the port.
Configuration options: [Disabled] [201] [209]

Midi Port Address [330]

Allows you to select the Game Port address or to disable the port.
Configuration options: [Disabled] [330] [300]

Midi Port IRQ [10]

Allows you to set the Midi port IRQ address. Configuration options: [5] [10]

2.4.7 USB Configuration

The items in this menu allows you to change the USB-related features. Select an item then press <Enter> to display the configuration options.

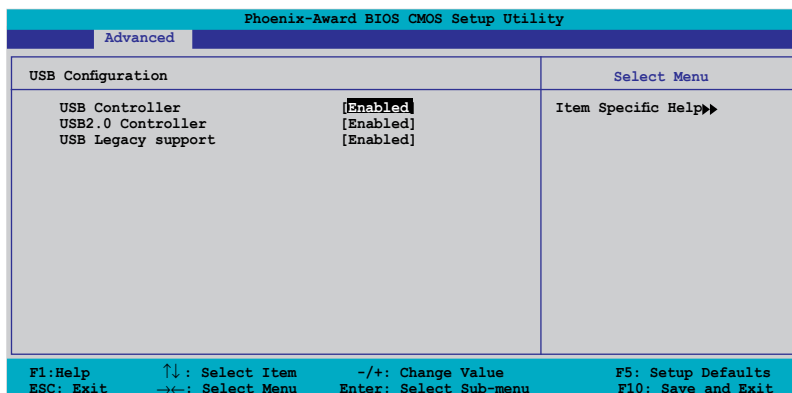

USB Controller [Enabled]

Allows you to enable or disable the onchip USB controller.
Configuration options: [Disabled] [Enabled]

USB 2.0 Controller [Enabled]

Allows you to enable or disable the USB 2.0 controller.
Configuration options: [Disabled] [Enabled]

USB Legacy Support [Enabled]

Allows you to enable or disable support for USB devices on legacy operating systems (OS). Configuration options: [Disabled] [Enabled]

2.5 Power menu

The Power menu items allow you to change the settings for the Advanced Configuration and Power Interface (ACPI) and the Advanced Power Management (APM). Select an item then press <Enter> to display the configuration options.

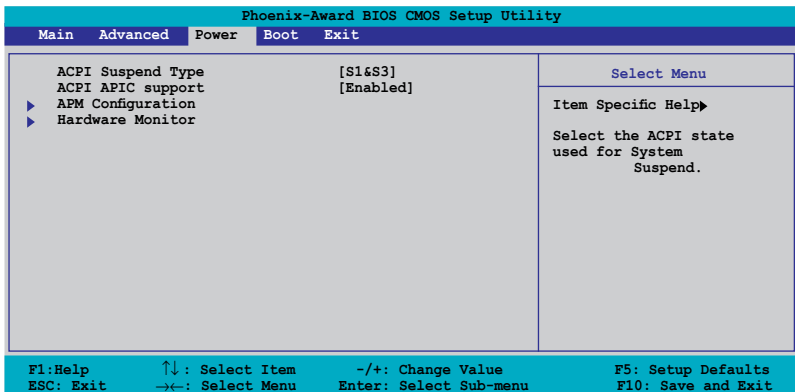

2.5.1 ACPI Suspend Type [S1&S3]

Allows you to select the Advanced Configuration and Power Interface (ACPI) state to be used for system suspend.

Configuration options: [S1 (POS)] [S3 (STR)] [S1&S3]

2.5.2 ACPI APIC Support [Enabled]

Allows you to enable or disable the Advanced Configuration and Power Interface (ACPI) support in the Application-Specific Integrated Circuit (ASIC). When set to Enabled, the ACPI APIC table pointer is included in the RSDT pointer list. Configuration options: [Disabled] [Enabled]

2.5.3 APM Configuration

Phoenix-Award BIOS CMOS Setup Utility			
Power			
APM Configuration		Select Menu	
Restore on AC Power Loss	Disabled	Item Specific Help▶▶ Press [ENTER] to select whether or not to restart the system after AC power loss.	
HDD Down In Suspend	[Disabled]		
PWR Button < 4 secs	[Instant-Off]		
Power On By PCI Devices	[Disabled]		
Power On By External Modems	[Disabled]		
Power-On by RTC Alarm	[Disabled]		
x Date (of Month) Alarm	0		
x Time (hh:mm:ss) Alarm	0 : 0 : 0		
Power Up By PS/2 Mouse	[Disabled]		
Power Up By PS/2 Keyboard	[Disabled]		
F1: Help	↑↓: Select Item	-/+ : Change Value	F5: Setup Defaults
ESC: Exit	→←: Select Menu	Enter: Select Sub-menu	F10: Save and Exit

Restore on AC Power Loss [Disabled]

Allows you to enable or disable the Restore on AC Power Loss function.
Configuration options: [Disabled] [Enabled]

HDD Down In Suspend [Disabled]

Allows you to enable or disable the HDD Down In Suspend feature.
Configuration options: [Disabled] [Enabled]

PWR Button < 4 secs [Instant-Off]

Allows you to set the event after the power button is pressed for more than 4 seconds. Configuration options: [Suspend] [Instant-Off]

Power On By PCI Devices [Disabled]

When set to [Enabled], this parameter allows you to turn on the system through a PCI LAN or modem card. This feature requires an ATX power supply that provides at least 1A on the +5VSB lead.
Configuration options: [Disabled] [Enabled]

Power On By External Modems [Disabled]

This allows either settings of [Enabled] or [Disabled] for powering up the computer when the external modem receives a call while the computer is in Soft-off mode. Configuration options: [Disabled] [Enabled]



The computer cannot receive or transmit data until the computer and applications are fully running. Thus, connection cannot be made on the first try. Turning an external modem off and then back on while the computer is off causes an initialization string that turns the system power on.

Power On By RTC Alarm [Disabled]

Allows you to enable or disable RTC to generate a wake event. When this item is set to Enabled, the items Date of Month Alarm and Time (hh:mm:ss) Alarm items become user-configurable with set values.

Configuration options: [Disabled] [Enabled]

Date (of Month) Alarm [Disabled]

To set the date of alarm, highlight this item and press <Enter> to display the Day of Month Alarm pop-up menu. Key-in a value within the specified range then press <Enter>. Configuration options: [Min=0] [Max=31]

Time (hh:mm:ss) Alarm [Disabled]

To set the time of alarm:

1. Highlight this item and press <Enter> to display a pop-up menu for the hour field.
2. Key-in a value (Min=0, Max=23), then press <Enter>.
3. Press <TAB> to move to the minutes field then press <Enter>.
4. Key-in a minute value (Min=0, Max=59), then press <Enter>.
5. Press <TAB> to move to the seconds field then press <Enter>.
6. Key-in a value (Min=0, Max=59), then press <Enter>.

Power Up By PS/2 Mouse [Disabled]

When set to [Enabled], this parameter allows you to use the PS/2 mouse to turn on the system. This feature requires an ATX power supply that provides at least 1A on the +5VSB lead.

Configuration options: [Disabled] [Enabled]

Power On By PS/2 Keyboard [Disabled]

Allows you to disable the Power On by PS/2 keyboard function or set specific keys on the PS/2 keyboard to turn on the system. This feature requires an ATX power supply that provides at least 1A on the +5VSB lead. Configuration options: [Disabled] [Space Bar] [Ctrl-ESC] [Power Key]

2.5.4 Hardware Monitor

The items in this sub-menu displays the hardware monitor values automatically detected by the BIOS. It also allows you to change CPU Q-Fan feature-related parameters. Select an item then press <Enter> to display the configuration options.

Phoenix-Award BIOS CMOS Setup Utility		
Power		
Hardware Monitor		Select Menu
Q-Fan Controller	[Disabled]	Item Specific Help▶▶ Press [Enter] to enable or disable
Vcore Voltage	[1.50V]	
3.3V Voltage	[3.31V]	
5V Voltage	[4.94V]	
12V Voltage	[11.26V]	
CPU Temperature	48°C	
M/B Temperature	38°C	
CPU FAN Speed	4962 RPM	
PWR FAN Speed	0 RPM	
CHA FAN1 Speed	0 RPM	
CPU Fan Speed warning	[800 RPM]	

F1: Help ↑↓: Select Item -/+ : Change Value F5: Setup Defaults
ESC: Exit →←: Select Menu Enter: Select Sub-menu F10: Save and Exit

Q-Fan Controller [Disabled]

Allows you to enable or disable the ASUS Q-Fan feature.
Configuration options: [Disabled] [Enabled]

VCORE Voltage, +12V Voltage, 3.3V Voltage, 5VCC Voltage

The onboard hardware monitor automatically detects the voltage output through the onboard voltage regulators. These items are not user-configurable.

CPU Temperature, M/B Temperature

The onboard hardware monitor automatically detects and displays the motherboard and CPU temperatures. These items are not user-configurable.

CPU Fan Speed, PWR Fan Speed, CHA Fan Speed

The onboard hardware monitor automatically detects and displays the CPU, Power, and Chassis fan speeds in rotations per minute (RPM). If the fan is not connected to the motherboard, the field shows 0. These items are not user-configurable.

CPU Fan Speed warning [800 RPM]

Allows you to set the CPU fan warning speed.
Configuration options: [Disabled] [800 RPM] [1200 RPM] [1600 RPM]

2.6 Boot menu

The Boot menu items allow you to change the system boot options. Select an item then press <Enter> to display the sub-menu.

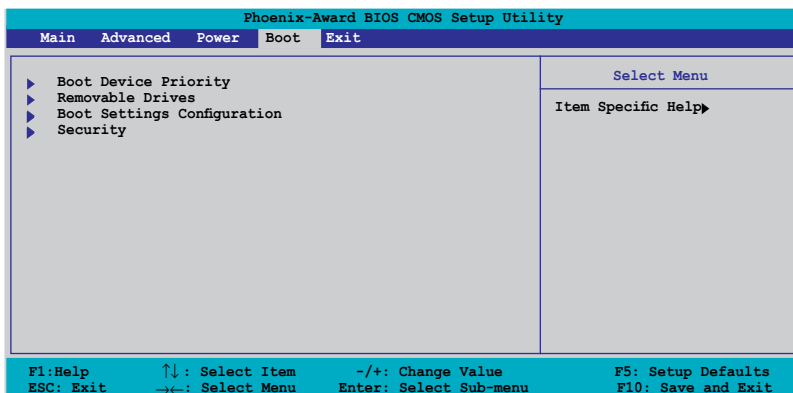

2.6.1 Boot Device Priority

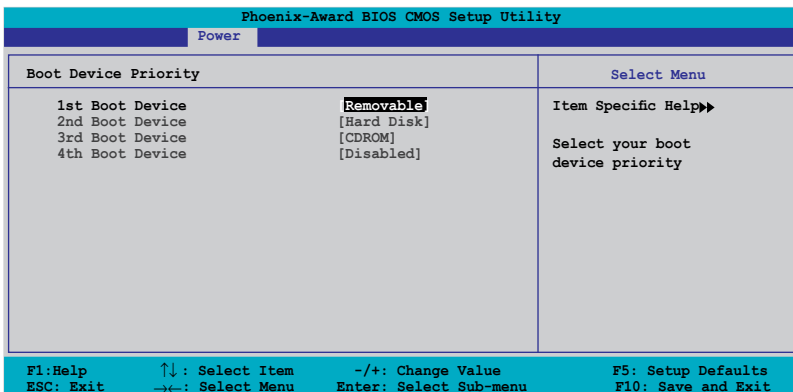

1st ~ xth Boot Device [Removable]

These items specify the boot device priority sequence from the available devices. The number of device items that appears on the screen depends on the number of devices installed in the system.

Configuration options: [Removable] [Hard Disk] [CDROM] [Legacy LAN] [Disabled]

2.6.2 Removable Drives

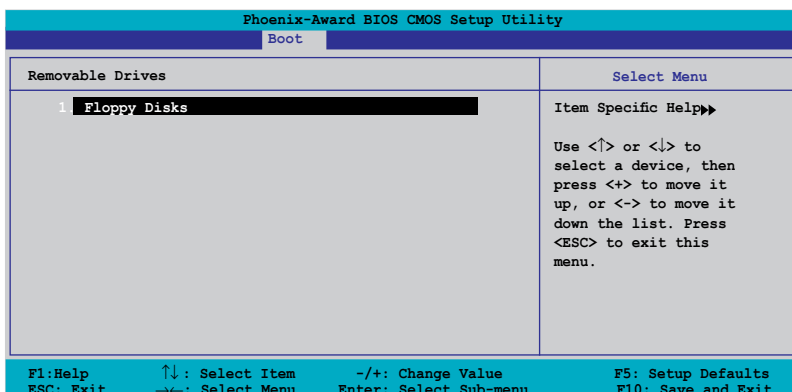

1. Floppy Disks

Allows you to assign a removable drive attached to the system.

2.6.5 Boot Settings Configuration

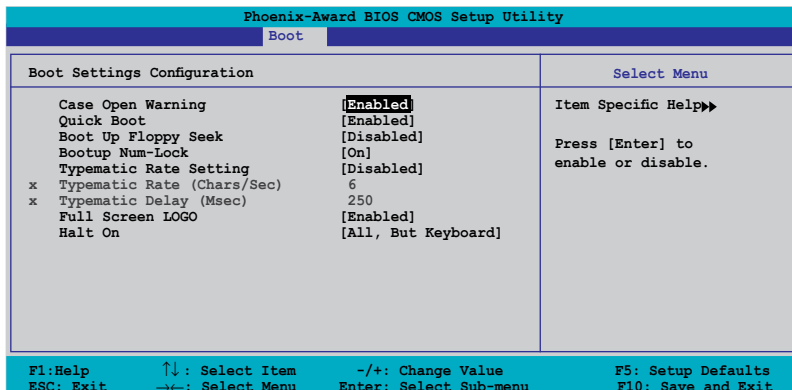

Case Open Warning [Enabled]

Enables or disables the chassis open status feature. Setting to Enabled, clears the chassis open status. Refer to section “1.10.2 Internal connectors” for setting details. Configuration options: [Disabled] [Enabled]

Quick Boot [Enabled]

Allows you to enable or disable the system quick boot feature. When Enabled, the system skips certain tests while booting. Configuration options: [Disabled] [Enabled]

Boot Up Floppy Seek [Disabled]

Enable this item to allow the BIOS to check a floppy drive during POST.
Configuration options: [Disabled] [Enabled]

Bootup Num-Lock [On]

Allows you to select the power-on state for the NumLock.
Configuration options: [Off] [On]

Typematic Rate Setting [Disabled]

Allows you to set the keystroke rate. Enable this item to configure the Typematic Rate (Chars/Sec) and the **Typematic Delay (Msec)**.
Configuration options: [Disabled] [Enabled]



The items **Typematic Rate (Chars/Sec)** and **Typematic Delay (Msec)** becomes user-configurable only when the item Typematic Rate Setting is enabled.

Typematic Rate (Chars/Sec) [6]

Allows you to select the rate at which a character repeats when you hold a key. Configuration options: [6] [8] [10] [12] [15] [20] [24] [30]

Typematic Delay (Msec) [250]

Allows you to set the delay before keystrokes begin to repeat.
Configuration options: [250] [500] [750] [1000]

Full Screen LOGO [Disabled]

Allows you to enable or disable the full screen logo display feature.
Configuration options: [Disabled] [Enabled]



Make sure that the above item is set to [Enabled] if you want to use the ASUS MyLogo2™ feature.

Halt On [All, But Keyboard]

Allows you to error report type.
Configuration options: [All Errors] [No Errors] [All, But Keyboard] [All, But Diskette] [All, But Disk/Key]

2.6.4 Security

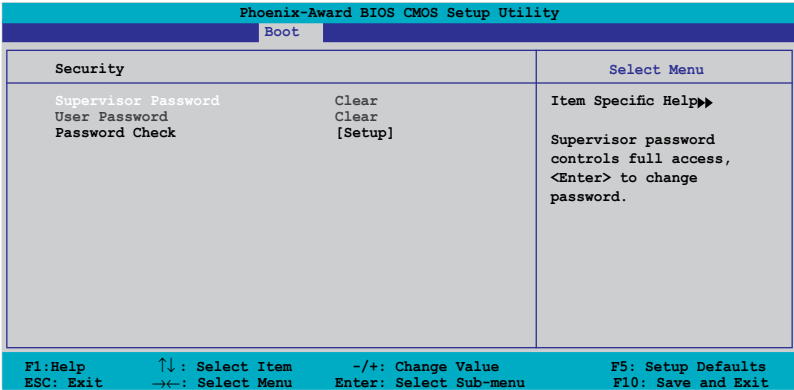

Supervisor Password User Password

These fields allow you to set passwords:

To set a password:

1. Select an item then press <Enter>.
2. Type in a password using a combination of a maximum of eight (8) alpha-numeric characters, then press <Enter>.
3. When prompted, confirm the password by typing the exact characters again, then press <Enter>. The password field setting is changed to [Set].

To clear the password:

1. Select the password field and press <Enter> twice. The following message appears:



2. Press any key to continue. The password field setting is changed to Clear.

A note about passwords

The Supervisor password is required to enter the BIOS Setup program preventing unauthorized access. The User password is required to boot the system preventing unauthorized use.

Forgot your password?

If you forget your password, you can clear it by erasing the CMOS Real Time Clock (RTC) RAM. The RAM data containing the password information is powered by the onboard button cell battery. If you need to erase the CMOS RAM, refer to section "1.9 Jumpers" for instructions.

Password Check

This field requires you to enter the password before entering the BIOS setup or the system. Select [Setup] to require the password before entering the BIOS Setup. Select [System] to require the password before entering the system.

Configuration options: [Setup] [System]

2.7 Exit menu

The Exit menu items allow you to load the optimal or failsafe default values for the BIOS items, and save or discard your changes to the BIOS items.

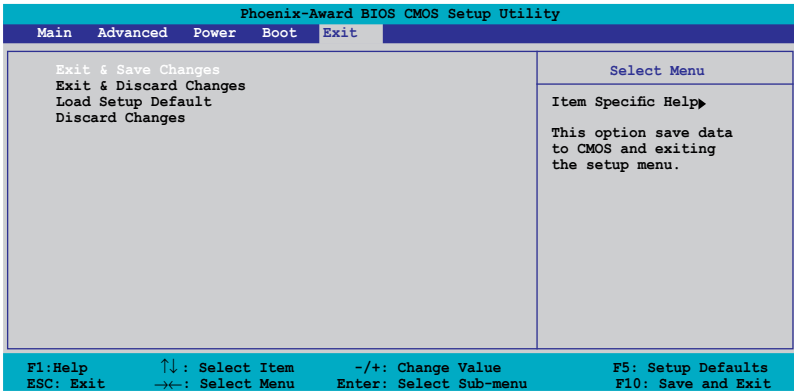

Pressing <Esc> does not immediately exit this menu. Select one of the options from this menu or <F10> from the legend bar to exit.

Exit & Save Changes

Once you are finished making your selections, choose this option from the Exit menu to ensure the values you selected are saved to the CMOS RAM. An onboard backup battery sustains the CMOS RAM so it stays on even when the PC is turned off. When you select this option, a confirmation window appears. Select **Yes** to save changes and exit.



If you attempt to exit the Setup program without saving your changes, the program prompts you with a message asking if you want to save your changes before exiting. Press <Enter> to save the changes while exiting.

Exit & Discard Changes

Select this option only if you do not want to save the changes that you made to the Setup program. If you made changes to fields other than System Date, System Time, and Password, the BIOS asks for a confirmation before exiting.

Load Setup Defaults

This option allows you to load the default values for each of the parameters on the Setup menus. When you select this option or if you press <F5>, a confirmation window appears. Select **Yes** to load default values. Select **Exit & Save Changes** or make other changes before saving the values to the non-volatile RAM.

Discard Changes

This option allows you to discard the selections you made and restore the previously saved values. After selecting this option, a confirmation appears. Select **Yes** to discard any changes and load the previously saved values.

This chapter describes the contents of the support CD that comes with the motherboard package.

3 Software support

3.1 Installing an operating system

This motherboard supports Windows® 2000/2003 Server/XP/64-bit XP operating systems (OS). Always install the latest OS version and corresponding updates to maximize the features of your hardware.



- Motherboard settings and hardware options vary. Use the setup procedures presented in this chapter for reference only. Refer to your OS documentation for detailed information.
- Make sure that you install Windows® 2000 Service Pack 4 or the Windows® XP Service Pack2 or later versions before installing the drivers for better compatibility and system stability.

3.2 Support CD information

The support CD that came with the motherboard package contains the drivers, software applications, and utilities that you can install to avail all motherboard features.



The contents of the support CD are subject to change at any time without notice. Visit the ASUS website(www.asus.com) for updates.

3.2.1 Running the support CD

Place the support CD to the optical drive. The CD automatically displays the Drivers menu if Autorun is enabled in your computer.



Click an icon to display support CD/motherboard information

Click an item to install



If Autorun is NOT enabled in your computer, browse the contents of the support CD to locate the file ASSETUP.EXE from the BIN folder. Double-click the ASSETUP.EXE to run the CD.

3.2.2 Drivers menu

The drivers menu shows the available device drivers if the system detects installed devices. Install the necessary drivers to activate the devices.



nVidia nForce Chipset Driver

Installs the NVIDIA® nForce™ Chipset driver.

SoundMAX ADI1986A Audio Driver

Installs the SoundMAX® ADI1986A audio controller and application.

USB 2.0 Driver

Installs the Universal Serial Bus 2.0 (USB 2.0) driver.

3.2.3 Utilities menu

The Utilities menu shows the applications and other software that the motherboard supports.



ASUS Ai Booster

Allows you to install the ASUS Ai booster software.

ASUS PC Probe II

This smart utility monitors the fan speed, CPU temperature, and system voltages, and alerts you of any detected problems. This utility helps you keep your computer in healthy operating condition.

ASUS Update

Allows you to download the latest version of the BIOS from the ASUS website.



Before using the ASUS Update, make sure that you have an Internet connection so you can connect to the ASUS website.

ASUS Screen Saver

Bring life to your computer screen by installing the ASUS screen saver.

ADOBE Acrobat Reader V7.0

Installs the Adobe® Acrobat® Reader V7.0 that allows you to open, view, and print documents in Portable Document Format (PDF).

Microsoft DirectX 9.0c

Installs the Microsoft® DirectX 9.0c driver. The Microsoft DirectX® 9.0c is a multimedia technology that enhances computer graphics and sound. DirectX® improves the multimedia features of your computer so you can enjoy watching TV and movies, capturing videos, or playing games in your computer. Visit the Microsoft website (www.microsoft.com) for updates.

Anti-virus Utility

The anti-virus application scans, identifies, and removes computer viruses. View the online help for detailed information.

3.2.4 Make Disk menu

The Make Disk menu contains items to create the NVIDIA® nForce™ 4 SATA RAID driver disk.



NVIDIA 32bit SATA RAID Driver

Creates the NVIDIA® 32bit SATA RAID driver.

NVIDIA 64bit SATA RAID Driver

Creates the NVIDIA® 64bit SATA RAID driver.

3.2.5 Manuals menu

The Manuals menu contains a list of supplementary user manuals. Click an item to open the folder of the user manual.



- Most user manual files are in Portable Document Format (PDF). Install the Adobe® Acrobat® Reader from the Utilities menu before opening a user manual file.
- Some user manuals listed in this menu may not be applicable for this motherboard model.



Nvidia RAID User's Guide

Allows you to open the Nvidia® RAID user guide.

Nvidia RAID Disk Alert User's Guide

Allows you to open the Nvidia® RAID disk alert user guide.

3.2.6 ASUS Contact information

Click the Contact tab to display the ASUS contact information. You can also find this information on the inside front cover of this user guide.



Free Manuals Download Website

<http://myh66.com>

<http://usermanuals.us>

<http://www.somanuals.com>

<http://www.4manuals.cc>

<http://www.manual-lib.com>

<http://www.404manual.com>

<http://www.luxmanual.com>

<http://aubethermostatmanual.com>

Golf course search by state

<http://golfingnear.com>

Email search by domain

<http://emailbydomain.com>

Auto manuals search

<http://auto.somanuals.com>

TV manuals search

<http://tv.somanuals.com>