INSTALLATION INSTRUCTIONS

SINGLE PACKAGE AIR CONDITIONERS

MODELS

P1124A2	P1224A1
P1130A2	P1230A1
P1136A2	P1236A1
P1142A3	P1242A1
P1148A2	P1248A2
P1060A1	



CLIMATE CONTROL SOLUTIONS

Bard Manufacturing Company
Bryan, Ohio 43506

Since 1914 . . . Moving ahead just as planned

Manual : 2100-353C
Supersedes: 2100-353B
File: Volume II Tab 10
Date: 01-09-03

© Copyright 2003

CONTENTS

Getting Other Informations and Publications

General Instructions

Important	2
Shipping Damage	2
General	2
Field Installed Heater Packages (Optional)	2

Installation

Location	9
Typical Installations	9
Condensate Drain Trap	14
Air Filters	14
Wiring – Main Power	15
Wiring – 24V Low Voltage Control Circuit	15
Transformer Taps	15
Thermostats	15

Figures

Figure 1 Unit Dimensions	8
Figure 2 Slab Mounting at Ground Level	10
Figure 3 Airflow and Service Access Clearances	10
Figure 4 Roof Top Application	11
Figure 5 Elevated Mounting Platforms	11
Figure 6 Prefabricated Rood Curb Specifications	12
Figure 7 Field Fabricated Curbing	13
Figure 8 Condensate Drain Trap	14
Figure 9 Low Voltage Wiring	16
Figure 10 Fan Blade Setting	19
Figure 11 Brazing Diagram	20

Start Up and Operation

Three Phase Scroll Compressor Start Up Information	17
Sequence of Operation	17
Start Up Notes	17
Indoor Blower Motor	17
Compressor Control Module	17
Adjustments	18

Service and Troubleshooting

Service Hints	19
Pressure Service Ports	19
Refrigerant Charge	19
Fan Blade Settings	19
Suction and Discharge Tube Brazing	20
Pressure Table	14
Wiring Diagrams	15-16

Troubleshooting ECM Blower Motors 23-24

Tables

Table 1 Rated CFM & ESP	2
Table 2 Electrical Specifications	3
Table 2A Electrical Specifications	4
Table 2B Electrical Specifications	5
Table 3 Option Field Installed Heater Packages .	6
Table 4 Electric Heater Table	8
Table 5 Unit Dimensions	5
Table 6 Roof Curb Details	13
Table 7 Dimension for Figure 7	13
Table 8 Filter Requirements & Sizes	14
Table 9 Thermostat Wire Size	15
Table 10 Wall Thermostat and Subbase Combinations	15
Table 11 Suction Line Temperatures	19
Table 12 Fan Blade Setting Dimensions	19
Table 13 Indoor Blower Performance	20
Table 14 Pressure Table	21
Table 14A Pressure Table	22

Getting Other Information and Publications

These publications can help you install the air conditioner or heat pump. You can usually find these at your local library or purchase them directly from the publisher. Be sure to consult current edition of each standard.

National Electrical Code ANSI/NFPA 70

Standard for the Installation ANSI/NFPA 90A
of Air Conditioning and
Ventilating Systems

Standard for Warm Air ANSI/NFPA 90B
Heating and Air
Conditioning Systems

Load Calculation for ACCA Manual J
Residential Winter and
Summer Air Conditioning

Duct Design for Residential ACCA Manual D
Winter and Summer Air
Conditioning and Equipment Selection

FOR MORE INFORMATION, CONTACT THESE PUBLISHERS:

ACCA **Air Conditioning Contractors of America**
1712 New Hampshire Ave. N.W.
Washington, DC 20009
Telephone: (202) 483-9370
Fax: (202) 234-4721

ANSI **American National Standards Institute**
11 West Street, 13th Floor
New York, NY 10036
Telephone: (212) 642-4900
Fax: (212) 302-1286

ASHRAE **American Society of Heating, Refrigerating,
and Air Conditioning Engineers, Inc.**
1791 Tullie Circle, N.E.
Atlanta, GA 30329-2305
Telephone: (404) 636-8400
Fax: (404) 321-5478

NFPA **National Fire Protection Association**
Batterymarch Park
P.O. Box 9101
Quincy, MA 02269-9901
Telephone: (800) 344-3555
Fax: (617) 984-7057

GENERAL INSTRUCTIONS

IMPORTANT

The equipment covered in this manual is to be installed by trained, experienced service and installation technicians. All duct work, supply and return ducts, must be properly sized for the design air flow requirement of the equipment. ACCA is an excellent guide to proper sizing. All duct work or portions thereof not in the conditioned space should be properly insulated in order to both conserve energy and prevent condensation or moisture damage.

SHIPPING DAMAGE

Upon receipt of equipment, the carton should be checked for external signs of shipping damage. If damage is found, the receiving party must contact the last carrier immediately, preferably in writing, requesting inspection by the carrier's agent.

GENERAL

The refrigerant system is completely assembled and charged. All internal wiring is complete.

The unit is designed for use with or without duct work. Flanges are provided for attaching the supply and return ducts.

These instructions explain the recommended method to install the air cooled self-contained unit and the electrical wiring connections to the unit.

These instructions and any instructions packaged with any separate equipment required to make up the entire heat pump system should be carefully read before beginning the installation. Note particularly "Starting Procedure" and any tags and/or labels attached to the equipment.

While these instructions are intended as a general recommended guide, they do not supersede any national and/or local codes in any way. Authorities having jurisdiction should be consulted before the installation is made.

FIELD INSTALLED HEATER PACKAGES (OPTIONAL)

These packaged air conditions are manufactured without supplementary electric heaters. Supplementary heaters are available for simple, fast field installation.

A separate power circuit is required for the supplementary heaters.

IMPORTANT: Refer to Table 1 when designing duct work for maximum available static pressure with heater installed.

Refer to data shown in Table 3 and 4 for proper application information on all available heater combinations and what units they can be used with. It also shows the applicable circuit ampacities, fuse size, and wire size for each heater combination.

**TABLE 1
RATED CFM AND EXTERNAL STATIC PRESSURE (ESP)**

Model No.	Rated CFM	Recommended Airflow Range	Rated ESP	Max. ESP
P1124A2	800	720 - 880	0.20	0.50
P1224A1	800	Note 1	0.10	0.50
P1130A2	1125	1020 - 1275	0.20	0.50
P1230A1	1000	Note 1	0.15	0.50
P1136A2	1250	1150 - 1400	0.30	0.50
P1236A1	1100	Note 1	0.15	0.50
P1142A3	1400	1260 - 1540	0.20	0.40
P1242A1	1400	Note 1	0.20	0.50
P1148A2	1550	1400 - 1700	0.40	0.50
P1248A2	1550	Note 1	0.20	0.50
P1060A1	1700	1530 - 1870	0.20	0.50

NOTE: ECM motors provide rated CFM up to 0.50 ESP

**TABLE 2
ELECTRICAL SPECIFICATIONS**

Model	P1124A2	P1130A2	P1136A2	P1136A1-B	P1136A1-C	P1142A3
Electric Rating – 60 Hz – Circuit A	230/208-60-1	230/208-60-1	230/208-60-1	230/208-60-3	460-60-3	230/208-60-1
Operating Voltage Range	197 - 253	197 - 253	197 - 253	187 - 253	414 - 506	197 - 253
Minimum Circuit Ampacity	17	21	25	18	12	29
BCSC	10.3	13.6	16	11	6	18.5
Field Wire Size *	12	10	8	10	14	8
Ground Wire Size	12	10	10	10	14	10
Delay Fuse – Max. **	25	30	40	25	15	45
Total unit Amps – 230/208	11.7/12.3	15.4/16.9	17.1/18.7	12.3/12.9	7.3	23.1/24.2
Compressor – Circuit A						
Compressor Type	Scroll	Scroll	Scroll	Scroll	Scroll	Scroll
Volts	230/208	230/208	230/208	230/208	460	230/208
Rated Load Amps	8.4/9.0	12.1/13.6	13.8/15.4	9.0/9.6	4.9	17.0/18.5
Lock Rotor Amps	56/56	72.5/72.5	88/88	77/77	39	104/104
Fan Motor and Condenser						
Fan Motor – HP/RPM	1/5 - 1090	1/5 - 1075	1/5 - 1075	1/5 - 1075	1/5 - 1075	1/2 - 1075
Fan Motor Amps	1.2	1.6	1.6	1.6	1.0	2.5
Fan – Dia./CFM	20"/1942	20"/2400	20"/2100	20"/2000	20"/2000	24"/2850
Motor and Evaporator						
Blower Motor – HP/RPM	1/3 - 1075	1/5 - 1075	1/5 - 1075	1/5 - 1075	1/5 - 1075	1/2 - 1075
Blower Motor – Amps	2.1	2.6	2.6	2.6	1.4	3.2
CFM Cooling & ESP	800 @ 0.20	1125 @ 0.20	1250 @ 0.30	1275 @ 0.30	1275 @ 0.30	1400 @ 0.20
Charge (R22 oz.)	54	64	93	93	93	89
Shipping Weight (pounds)	300	310	330	330	330	390

**TABLE 2A
ELECTRICAL SPECIFICATIONS**

Model	P1148A2	P1148A2-B	P1148A2-C	P1060A1	P1060A1-B	P1060A1-C
Electric Rating – 60 Hz – Circuit A	230/208-60-1	230/208-60-3	460-60-3	230/208-60-1	460-60-3	460-60-3
Operating Voltage Range	197 - 253	187 - 253	414 - 506	197 - 253	187 - 253	414 - 506
Minimum Circuit Ampacity	32	24	12	42	28	14
BCSC	20.5	14.7	7	29	12	9
Field Wire Size *	8	10	12	8	8	12
Ground Wire Size	10	10	12	10	10	12
Delay Fuse – Max. **	50	35	15	60	45	20
Total unit Amps – 230/208	24.2/26.2	17.9/19.1	8.8	30.9/33.7	21.7/23.7	11.2
Compressor – Circuit A						
Compressor Type	Scroll	Scroll	Scroll	Scroll	Scroll	Scroll
Volts	230/208	230/208	460	230/208	230/208	460
Rated Load Amps	18.5/20.5	12.2/13.4	6	25.2/28.2	16/18	8.4
Lock Roter Amps	137/137	91/91	50	169/169	123/123	62
Fan Motor and Condenser						
Fan Motor – HP/RPM	1/3 - 850	1/3 - 850	1/3 - 850	1/3 - 850	1/3 - 850	1/3 - 850
Fan Motor Amps	2.5	2.5	1.2	2.5	2.5	1.2
Fan – Dia./CFM	24"/3100	24"/3100	24"/3100	24"/3100	24"/3100	24"/3100
Motor and Evaporator						
Blower Motor – HP/RPM	1/2 - 1075	1/2 - 1075	1/2 - 1075	1/2 - 1075	1/2 - 1075	1/2 - 1075
Blower Motor – Amps	3.2	3.2	1.6	3.2	3.2	1.6
CFM Cooling & ESP	1550 @ 0.40	1550 @ 0.40	1550 @ 0.40	1700 @ 0.20	1700 @ 0.20	1700 @ 0.20
Charge (R22 oz.)				120	120	120
Shipping Weight (pounds)	430	430	430	425	425	425

**TABLE 2B
ELECTRICAL SPECIFICATIONS**

Model	P1224A1	P1230A1	P1236A1	P1236A1-B	P1242A1	P1248A2	P1248A2-B
Electric Rating – 60 Hz – Circuit A	230/208-60-1	230/208-60-1	230/208-60-1	230/208-60-3	230/208-60-1	230/208-60-1	230/208-60-3
Operating Voltage Range	197 - 253	197 - 253	197 - 253	187 - 253	197 - 253	197 - 253	187 - 253
Minimum Circuit Ampacity	17	21	25	19	30	34	23
BCSC	10.3	13.5	16.2	10.9	18	21	12.8
Field Wire Size *	12	10	8	10	8	6	8
Ground Wire Size	12	10	10	10	10	10	10
Delay Fuse – Max. **	25	30	40	25	45	50	35
Tota unit Amps – 230/208	11.8/12.4	15.7/17.1	19.2/21.1	14.9/15.8	23.2/24.1	25.5/27	19.4/19.7
Compressor – Circuit A							
Compressor Type	Scroll	Scroll	Scroll	Scroll	Scroll	Scroll	Scroll
Volts	230/208	230/208	230/208	230/208	230/208	230/208	230/208
Rated Load Amps	8.4/9.0	11.4/12.8	14.3/16.2	10/10.9	16.4/17.3	18.5/20	12.4/12.7
Lock Roter Amps	56/56	76/76	90.5/90.5	77/77	104/104	137/137	91/91
Fan Motor and Condenser							
Fan Motor – HP/RPM	1/5 - 1090	1/5 - 1075	1/5 - 1075	1/5 - 1075	1/3 - 825	1/3 - 825	1/3 - 825
Fan Motor Amps	1.2	1.6	1.6	1.6	2.5	2.5	2.5
Fan – Dia./CFM	20"/1975	20"/2400	20"/2100	20"/2100	24"/2900	24"/2350	24"/2350
Motor and Evaporator							
Blower Motor – HP/RPM	1/3 Variable	1/2 Variable	1/2 Variable	1/2 Variable	1/2 Variable	1/2 Variable	1/2 Variable
Blower Motor – Amps	2.2	2.7	3.3	3.3	4.3	4.5	4.5
CFM Cooling & ESP	800 @ 0.10	1000 @ 0.15	1100 @ 0.15	1100 @ 0.15	1400 @ 0.20	1550 @ 0.20	1550 @ 0.20
Charge (R22 oz.)	53	88	102	102	118	151	151
Shipping Weight (pounds)	300	330	340	340	410	430	430

**TABLE 3
OPTIONAL FIELD INSTALLED HEATER PACKAGES
ONLY TO BE USED WITH THE MODELS INDICATED**

Heater Package Model	Volts & Phase	P1124A2	P1124A1	P1130A2	P1230A1	P1236A2	P1136A1-C	P1136A1-C	P1236A1	P1236A1-B	This column is left blank intentionally.
EH3PB-A05	240/208-1	S	NA	S	NA	S	A	A	NA	NA	
EH3PB-A08	240/208-1	S	NA	S	NA	S	A	A	NA	NA	
EH3PB-A10	240/208-1	S	NA	S	S	S	A	A	S	NA	
EH3PB-A15	240/208-1	NA	NA	S	NA	S	A	A	NA	NA	
EH3PC-A05	240/208-1	NA	S	NA	S	NA	NA	NA	S	NA	
EH3PC-A10	240/208-1	NA	S	NA	NA	NA	NA	NA	NA	NA	
EH3PC-A15	240/208-1	NA	NA	NA	S	NA	NA	NA	S	NA	
EH3PB-B09	240/208-3	A	NA	A	NA	A	S	A	NA	S	
EH3PB-B15	240/208-3	NA	NA	A	NA	A	S	A	NA	S	
EHPB-C09	480-3	NA	NA	A	NA	A	A	S	NA	NA	
EHPB-C15	480-3	NA	NA	A	NA	A	A	S	NA	NA	
Heater Package Model	Volts & Phase	P1142A3	P1242A1	P1148A2	P1148A2-B	P1148A2-C	P1248A2	P1248A2-B	P1060A1	P1060A1-B	P1060A1-C
EH5PB-A05	240/208-1	S	S	S	A	A	S	A	S	A	A
EH5PB-A10	240/208-1	S	S	S	A	A	S	A	S	A	A
EH5PB-A15	240/208-1	S	S	S	A	A	S	A	S	A	A
EH5PB-A20	240/208-1	S	NA	S	A	A	NA	NA	S	A	A
EH5PB-B09	240/208-3	A	A	A	S	A	A	S	A	S	A
EH5PB-B15	240/208-3	A	A	A	S	A	A	S	A	S	A
EH5PB-B18	240/208-3	A	NA	A	S	A	NA	NA	A	S	A
EH5PC-C09	480-3	A	NA	A	A	S	NA	NA	A	A	S
EH5PC-C15	480-3	A	NA	A	A	S	NA	NA	A	A	S
EH5PC-C18	480-3	A	NA	A	A	S	NA	NA	A	A	S

S = Standard Application – Heater volts and phase same as basic unit A = Alternate Application – Heater volts and phase different from basic unit.
N = Not Approved

**TABLE 4
OPTIONAL FIELD INSTALLED ELECTRIC HEATER TABLE**

Heater Pkg. Model No.	Unit Volts Phases	Htr. KW & Capacity @ 240 Volts		Htr. KW & Capacity @ 208 Volts		240/208V Htr. Amps	Heater Internal Fuses	Circuit B				
		KW	BTUH	KW	BTUH			No. Field Circuits	Min. Circuit Ampacity	①	②	③
										Max. Over Current Protection	Field Power Wiring	Ground Wire Size
EH3PB-A05	240/208-1	5	17,100	3.75	12,800	20.8/18.1		1	26/23	30/25	10/10	10
EH3PB-A08	240/208-1	8	27,300	6.00	20,500	33.3/28.8		1	42/36	45/40	10/10	10
EH3PB-A10	240/208-1	10	34,100	7.50	26,000	41.6/36.2		1	53/46	60/50	6/8	10
EH3PB-A15	240/208-1	15	51,200	11.25	38,400	62.5/54.1	30/60	1	79/68	80/70	4/4	8
EH3PC-A08	240/208-1	5	17,100	3.75	12,800	20.8/18.1		1	26/23	30/25	10/10	10
EH3PC-A10	240/208-1	10	34,100	7.50	26,000	41.6/36.2		1	53/46	60/50	6/8	10
EH3PC-A15	240/208-1	15	51,200	11.25	38,400	62.5/54.1	30/60	1	79/68	80/70	4/4	8
EH5PB-A05	240/208-1	5	17,100	3.75	12,800	20.8/18.1		1	26/23	30/25	10/10	10
EH5PB-A10	240/208-1	10	34,100	7.50	26,000	41.6/36.2		1	53/46	60/50	6/8	10
EH5PB-A15	240/208-1	15	51,200	11.25	38,400	62.5/54.1	30/60	1	79/68	80/70	4/4	8
EH5PB-A20	240/208-1	20	68,200	15.00	51,200	83.2/72.1	60/60	1	104/91	110/100	2/3	6
EH3PB-B09	240/208-3	9	30,700	6.75	23,000	21.7/18.7		1	28/24	30/25	10/10	10
EH3PB-B15	240/208-3	15	51,200	11.25	38,400	36.2/31.2		1	46/39	50/40	8/8	10
EH5PB-B09	240/208-3	9	30,700	6.75	23,000	21.7/18.7		1	28/24	30/25	10/10	10
EH5PB-B15	240/208-3	15	51,200	11.25	38,400	36.2/31.2		1	46/39	50/40	8/8	10
EH5PB-B18	240/208-3	18	61,400	13.50	46,100	43.4/37.5		1	55/47	60/50	6/8	10
EH3PB-C09	480-3	9	30,700	8.26	28,200	10.8		1	15	15	14	14
EH3PB-C15	480-3	15	51,200	13.77	47,000	18.0		1	23	25	10	10
EH5PB-C09	480-3	9	30,700	8.26	28,200	10.8		1	15	15	14	14
EH5PB-C15	480-3	15	51,200	13.77	47,000	18.0		1	23	25	10	10
EH5PB-C18	480-3	18	61,400	16.53	56,400	21.7		1	28	30	10	10

- ① Time Delay fuses of "HACR" type circuit breakers must be used for 60 and smaller sizes. Standard fuses or circuit breakers are suitable for sizes 70 and larger. 480V circuit breakers are not "HACR" type.
- ② Based on wire suitable for 75 degree C. Other wiring materials must be rated for marked "Minimum Circuit Ampacity" or greater.
- ③ Based upon Table 250-95 of N.E.C. 1993. See electric data for basic heat pump for Circuit A wiring specification requirements.

IMPORTANT: While this electrical data is presented as a guide, it is important to electrically connect properly sized fuses and conductor wires in accordance with the National Electrical Code and all existing local codes.

**FIGURE 1
DIMENSIONS OF UNITS**

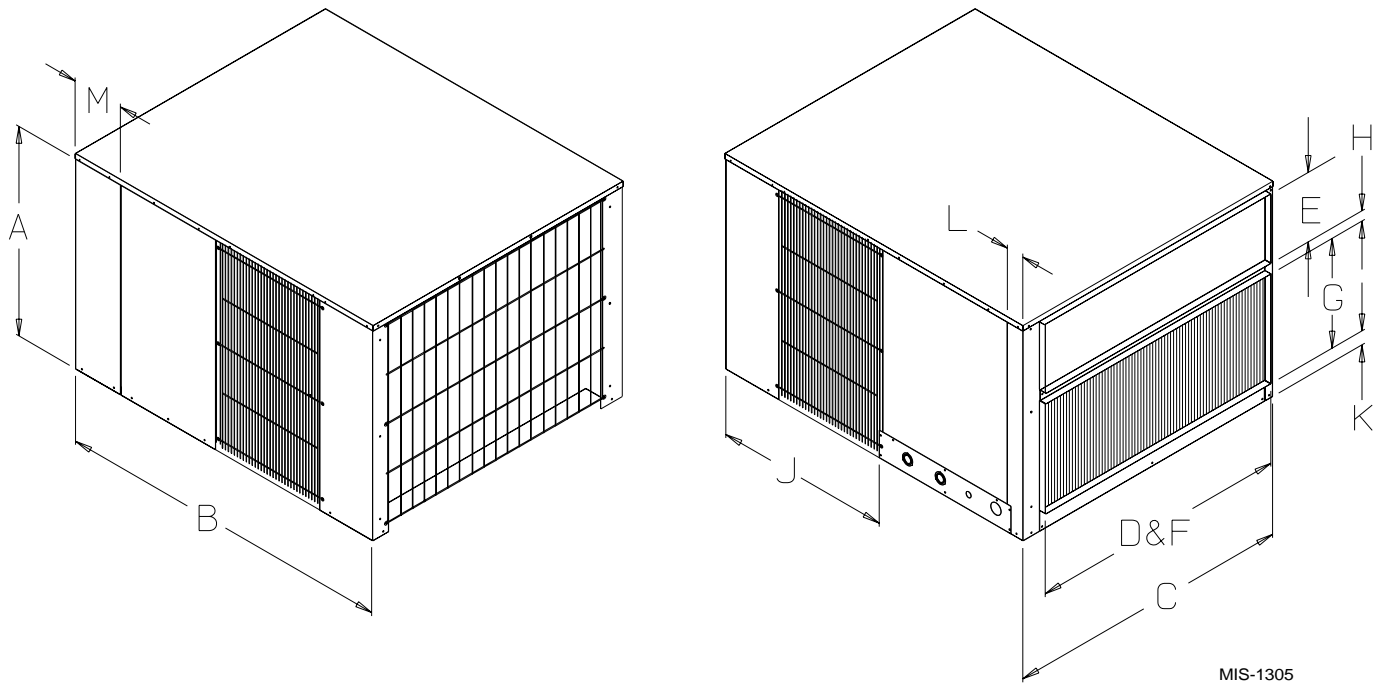

MIS-1305

**TABLE 5
DIMENSIONS OF UNITS**

Model No.	Nominal Cabinet Dimensions (Inches)							Duct Opening (Inches)				H
								Discharge		Return Air		
	A	B	C	J	K	L	M	D	E	F	G	
P1124A2 P1224A1 P1130A2 P1230A1 P1136A2 P1236A1	24-1/4	48-3/16	38-1/8	26-1/8	2-1/8	9/16	9/16	33	6	33	14	7/8
P1142A3 P1242A1 P1148A2 P1248A2 P1060A1	31-1/4	50	42	26	3	2-3/4	7-9/16	38	10	38	16	1-3/8

LOCATION

GENERAL

The unit must be located outside, or in a well ventilated area. It must not be in the space being heated or cooled. A sound absorbing material should be considered if the unit is to be installed in such a position or location that might cause transmission of sound or vibration to the living area or adjacent buildings.

SLAB MOUNTING

In areas where winter temperatures *DO NOT* go below 32° F for periods over twelve hours, the unit may be slab mounted at grade level. When installing unit at grade level, install on a concrete slab at least four inches above finished grade level. Slab should have a slope tolerance away from the building structure of at least 1/4 inch per foot, while being level from side to side. Place slab in a location where runoff water from higher ground will not collect around unit. See Figure 2.

A minimum of 18 inches should be provided between the coil inlet and any building surfaces. Provide at least four feet between coil outlet and any building wall, fences or other vertical structures. Provide a minimum of three feet clearance on the service access side of the unit. See Figure 3.

ROOF MOUNTING

When a unit is installed in areas where low ambient temperatures or strong winter winds exist, it should be placed for prevailing winter winds are not in direct line with the outdoor coil. If this is not possible, a wind barrier should be constructed. Place barrier 24 inches from the coil inlet side of the unit and in the direction of prevailing winds. Size barrier at least the same height and width as the unit. This may be necessary on ground level installations, also. See Figure 4.

WINTER INSTALLATION BELOW 32°F

In areas where winter conditions go below 32°F for extended periods, the unit must be elevated above the mounting surface to prevent snowfall or ice accumulation from interfering with the operation of the unit. A minimum of twelve inch elevation is recommended, while greater elevation may be required for areas of high snow accumulation. Poured concrete, steel framework, brick, cement block, etc., can be utilized to construct a suitable raised mounting platform. See Figure 5.

TYPICAL INSTALLATIONS

1. **ROOF MOUNTED** – The unit is mounted on a sturdy base on the roof of the building. Return air to the unit is brought through a single return grille (grilles with built-in filters are best since they enable easy access for filter changing). Return air ducts are attached to the lower section of the front panel. Supply air is brought from the unit to attic duct work or to a furred down hall. Supply air duct is attached to the top of the front panel.

CAUTION: All outdoor duct work must be thoroughly insulated and weatherproofed. All attic duct work must be thoroughly insulated. Two inch thick insulation with suitable vapor barrier is recommended for both outdoor and attic runs.

In roof top installation, as in all installations, the air conditioner must be level from side to side. However, the unit should have a pitch along the length to assure complete external drainage of precipitation and of defrost condensate. See Figures 6 and 7, and Tables 6 and 7.

2. **CRAWL SPACE** – Duct work installed in crawl space must be well insulated and provided with a vapor barrier. In addition, the crawl space must be thoroughly ventilated and provided with a good vapor barrier as a ground cover. It is most desirable to install the unit will be outdoors rather than inside the crawl space, so that it will be readily accessible for service.
3. **SLAB MOUNTED AT GROUND LEVEL** – This type installation is ideal for homes with a slab floor construction where a roof mounted unit is not desired. The supply and return duct work can be run through a furred closet space.
4. **THROUGH THE WALL** – This type installation requires a suitable framework to be fabricated capable of withstanding the unit weight. Normally the unit will be insulated so as to minimize supply and return duct work.

**FIGURE 2
SLAB MOUNTING AT GROUND LEVEL
(Above 32°F Outside Temperature)**

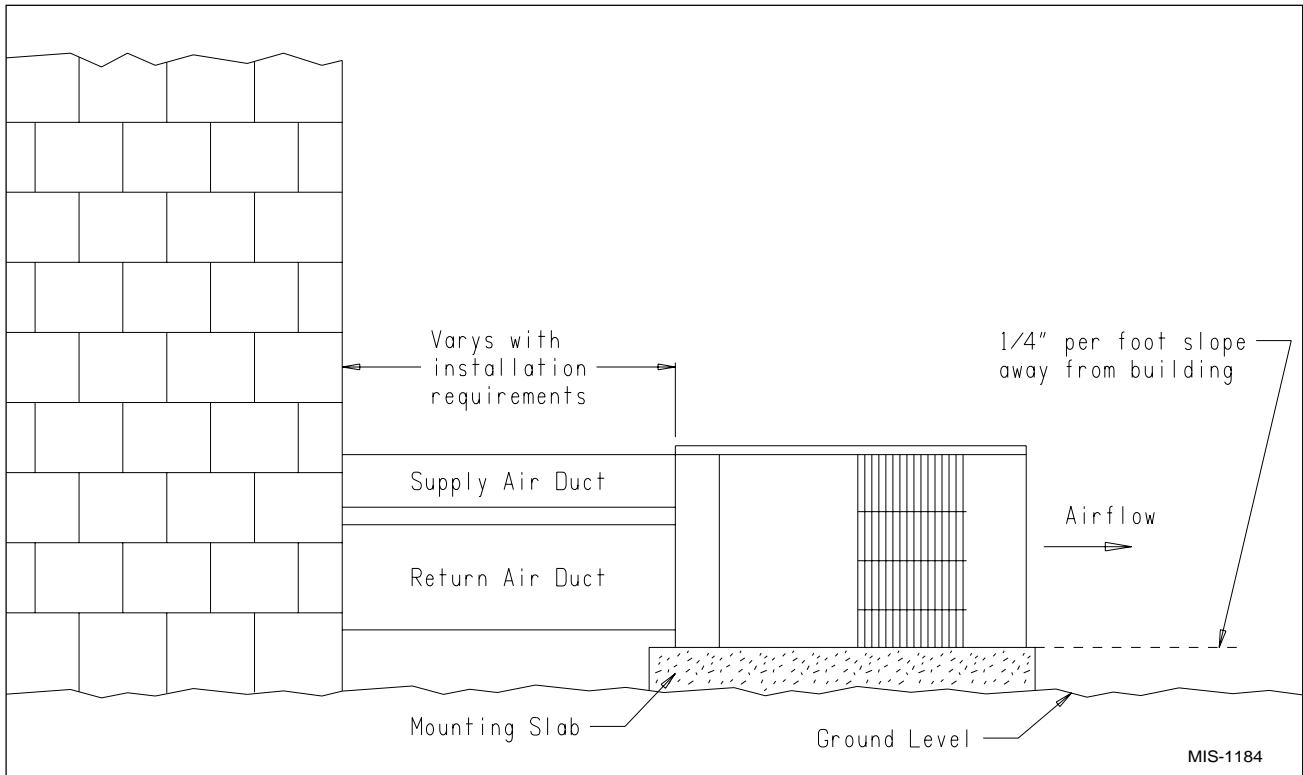

**FIGURE 3
AIRFLOW AND SERVICE ACCESS CLEARANCES**

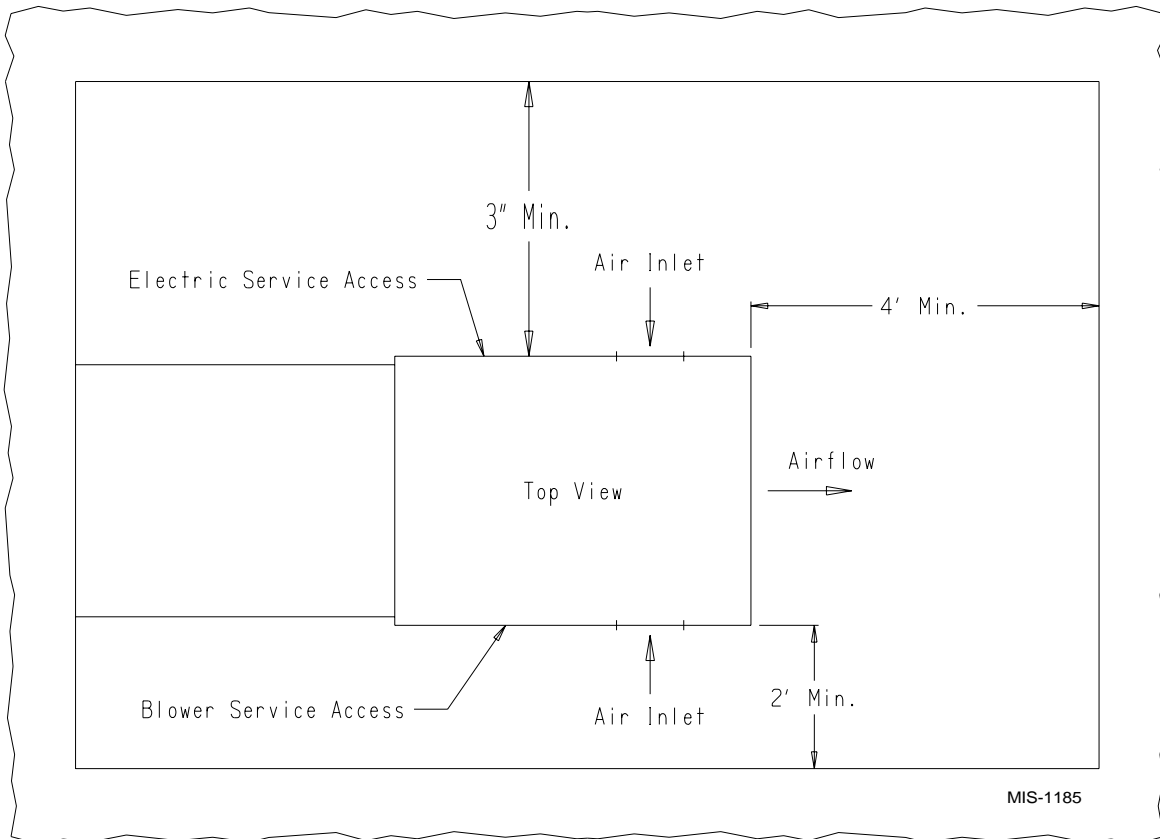

FIGURE 4
ROOF TOP APPLICATION
(May also be required for ground level installations)

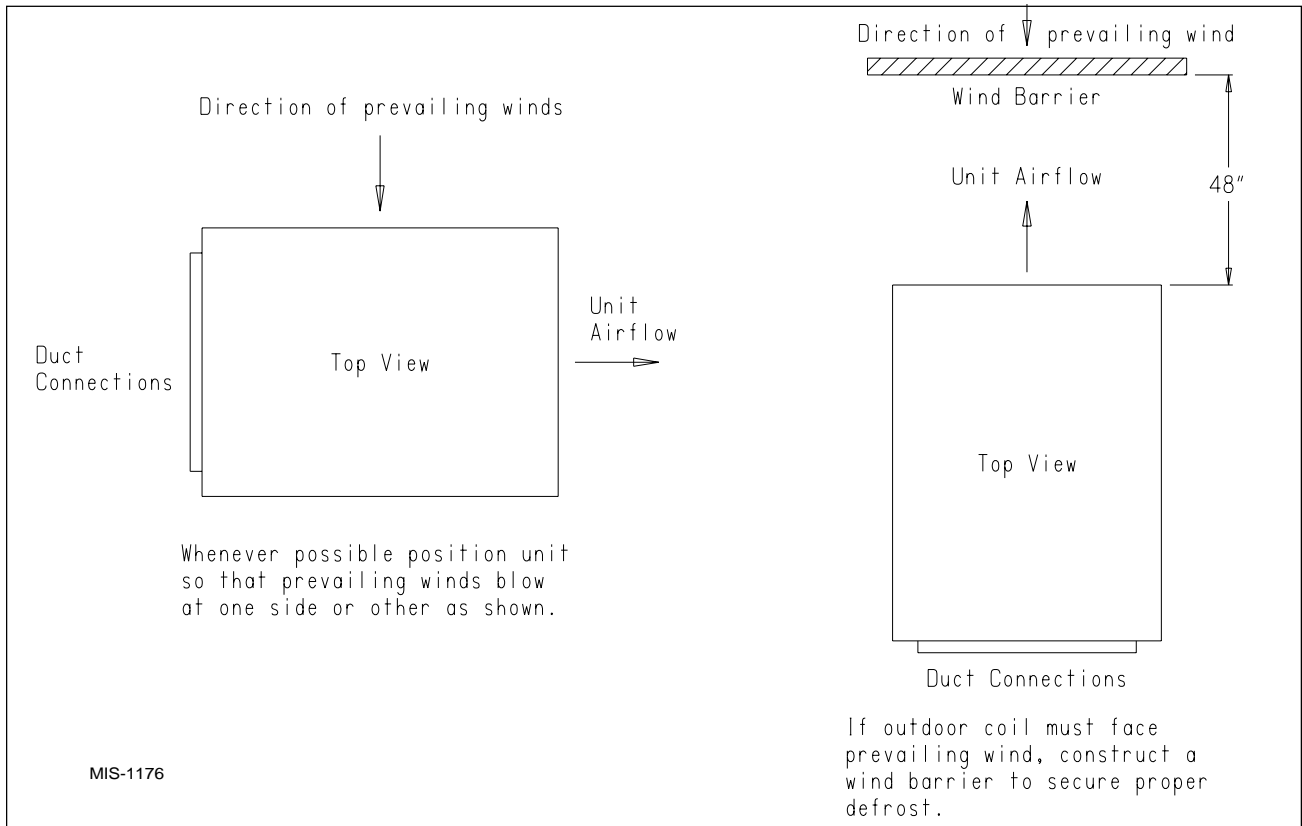

FIGURE 5
ELEVATED MOUNTING PLATFORMS

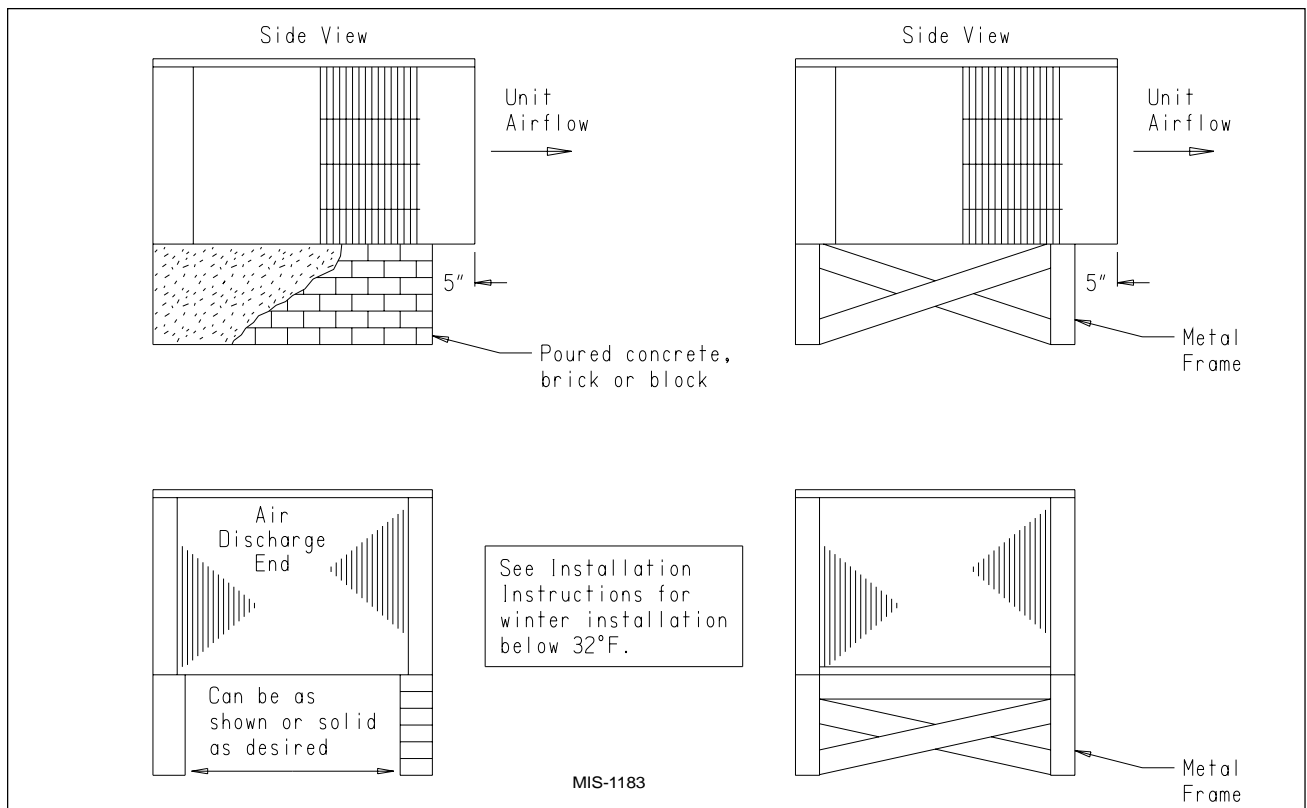
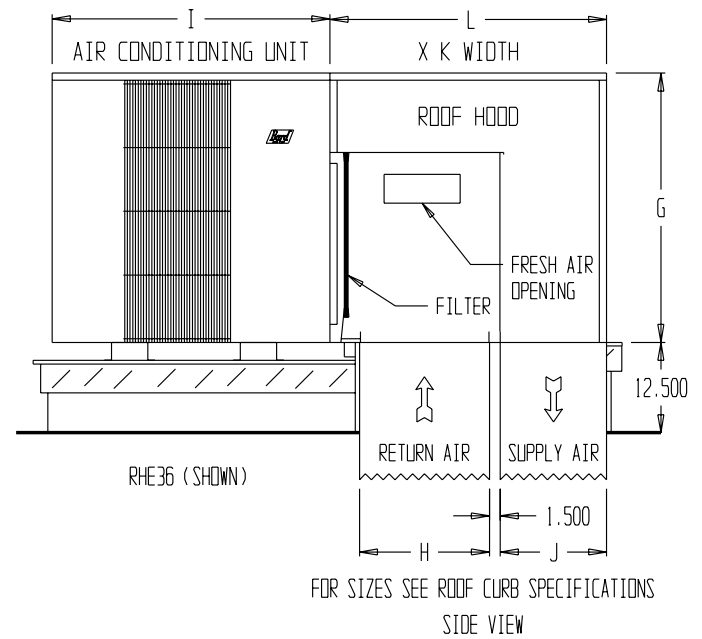
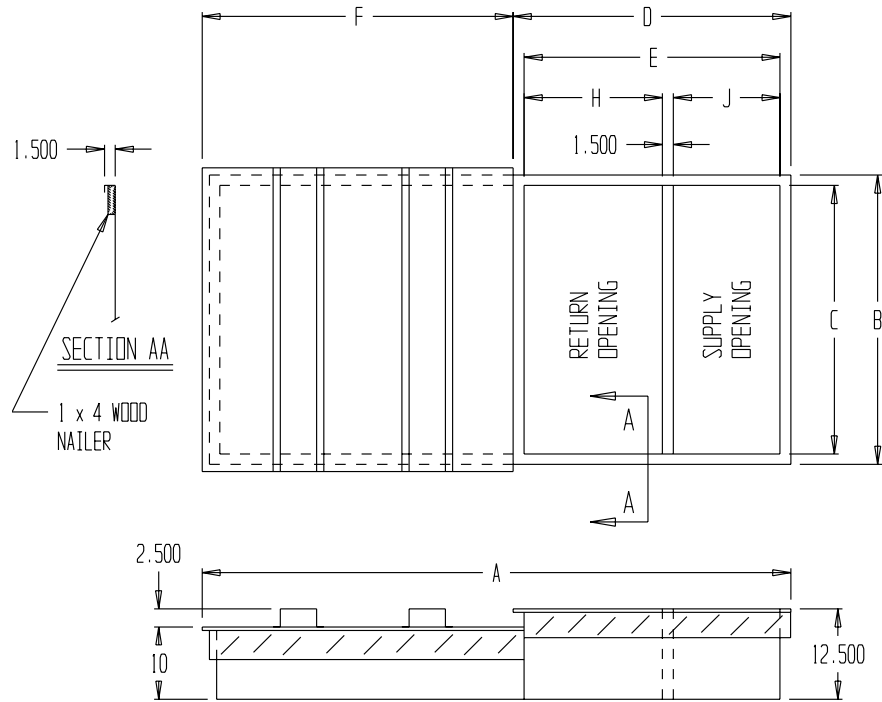

FIGURE 6
PREFABRICATED ROOF CURB SPECIFICATIONS
HEAVY GAUGE GALVANIZED WITH WOOD NAILING STRIP, WELDED/LEAKPROOF
ONCE PIECE CONSTRUCTION – READY TO INSTALL



MIS-1177C

**TABLE 6
ROOF CURB DETAILS
(Refer to Figure 7)**

Unit Model	Roof Hood Model	Roof Curb Model	Roof Curb Details											
			A	B	C	D	E	F	G	H	I	J	K	L
P1124A3 P1224A2 P1130A2 P1230A1 P1136A2 P1236A1	RHE-36	9042-003	80.375	40.25	37.25	38.375	35.375	42	24.25	19.125	48.188	14.75	38.125	38.25
P1142A3 P1242A1 P1148A2 P1248A2 P1060A1	RHE-60	9042-004	82.375	44.125	41.125	38.375	35.375	44	31.25	19.125	50	14.75	42	38.25

**FIGURE 7
FIELD FABRICATED CURBING**

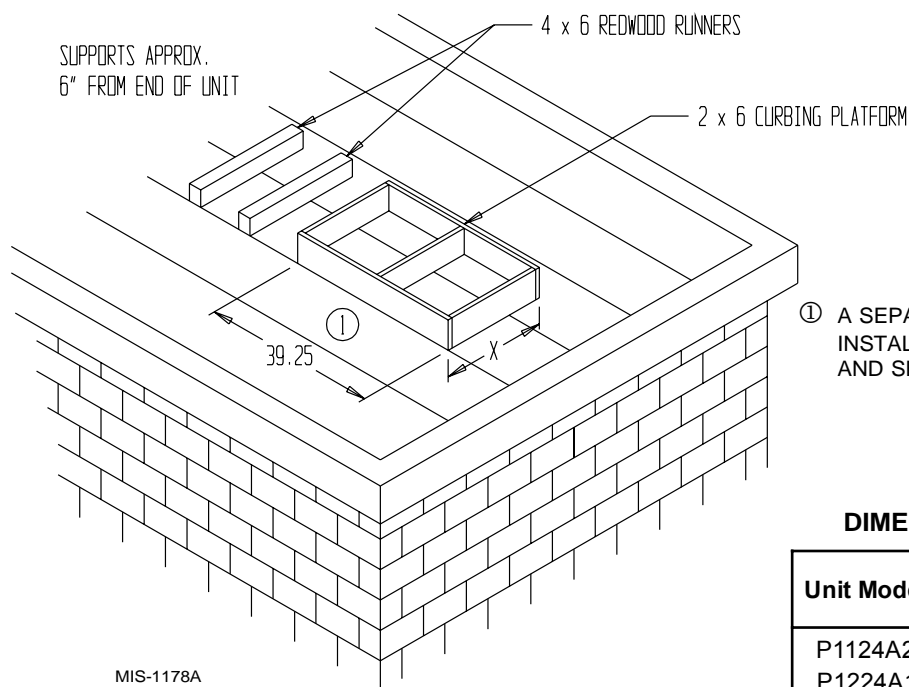

① A SEPARATE METAL FLASHING SHOULD BE INSTALLED AROUND WOOD CURBING. CAULK AND SEAL ALL JOINTS AND WEATHERPROOF.

**TABLE 7
DIMENSION FOR X IN FIG. 7**

Unit Model	Roof Hood Model	Dimension X
P1124A2 P1224A1 P1130A2 P1230A1 P1136A2 P1236A1	RHE-36	41
P1142A3 P1242A1 P1148A2 P1248A2 P1060A1	RHE60	44-7/8

MIS-1178A

5. **OTHER INSTALLATIONS** – Many other installations are possible with the packaged air conditioner. No matter what the installation, always consider the following facts:

- A. Insure that the discharge air is not obstructed in any way so as to cause operation difficulties.
- B. The indoor coil drain pan is equipped with a coupling that must be piped through a condensate drain trap to a suitable drain.
- C. Always mount the unit in such a position that it may be easily reached for servicing and maintenance.
- D. Insure that the unit is clear so that proper air flow over the outdoor coil will be maintained.

If this unit is operated in cooling below a 65° outdoor ambient temperature, the installation of low ambient controls (CMA-6) to unit is required.

CONDENSATE DRAIN TRAP

It is very important to provide a trap in the condensate drain line to allow a positive liquid seal in the line and assure correct drainage from the coil condensate pan.

Install condensate drain trap shown in Figure 8. Use drain connection size or larger. Do not operate unit without trap. Unit must be level or slightly inclined toward drain. With a trap installed on a unit located in an unconditioned area, water in the trap may freeze. It is recommended that the trap material be of a type that will allow for expansion of water when it freezes.

AIR FILTERS

Air filters for the return air side of the system are not provided as part of these models, and must be field supplied and installed as part of the final installation.

Prior thought should be given to return air location and placement of the air filter(s). The air filter(s) must be of adequate size and readily accessible to the operator of the equipment. Filters must be adequate in size and properly maintained for proper operation. If this is not done, excessive energy use, poor performance, and multiple service problems will result. *It is impossible to oversize air filters.* Generous sizing will result in cleaner air and coils as well as lower operating costs and extend the time between required changes. Table 8 shows minimum filter areas and recommended filter sizes. Actual filter sizes can vary with the installation due to single or multiple returns utilizing a filter/grille arrangement or being placed immediately ahead of the indoor coil face in the return air duct.

**TABLE 8
FILTER REQUIREMENTS & SIZES**

Model No.	Minimum Filter Area	Recommended Size
P1124A2 P1224A1 P1130A2 P1230A1 P1136A2 P1236A1	462 Square Inches (3.21 Square Feet)	15x30-5/8x1
P1142A3 P1242A1 P1148A2 P1248A2 P1060A1	608 Square Inches (4.62 Square Feet)	(2) 16x20x1

NOTE: If roof hood accessory is to be used, information on air filters may be found under that heading in this manual. Air filters are supplied as part of that package.

**FIGURE 8
CONDENSATE DRAIN TRAP**

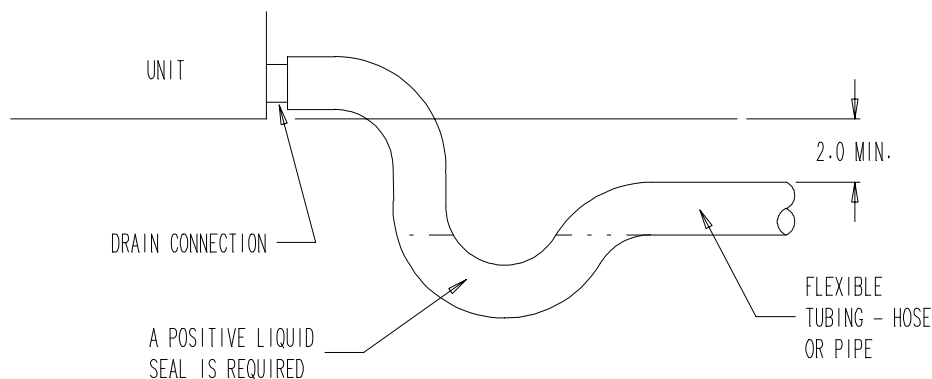

MIS-136

WIRING – MAIN POWER

Refer to the unit rating plate for wire sizing information and maximum fuse size. Each outdoor unit is marked with a “Minimum Circuit Ampacity”. This means that the field wiring used must be sized to carry that amount of current. If field installed heaters are added to the basic unit, a second separate power supply circuit will be required. The heater rating plate located adjacent to the basic unit rating plate will show the appropriate circuit ampacity fuse size, etc. (Also see “Electrical Specifications” on pages 3, 4 and 5.) *All models are suitable for connection with copper wire only.* These instructions **must** be adhered to. Refer to the National Electrical Code for complete current carrying capacity data on the various insulation grades of wiring material.

The electrical specifications list fuse and wire sizes (75°F copper) for all models including the most commonly used heater sizes.

The unit rating plate lists a “Maximum Time Delay Fuse” or “HACR” type circuit breaker that is to be used with the equipment. The correct size must be used for proper circuit protection and also to assure that there will be no nuisance tripping due to the momentary high starting current of the compressor.

WIRING – 24V LOW VOLTAGE CONTROL CIRCUIT

Five (5) wires should be run from thermostat subbase to the 24V terminal board in the unit. A five conductor, 18 gauge copper, color-coded thermostat cable is recommended. The connection points are shown in Figure 9.

THERMOSTATS

See specific wiring information for the different models, heater KWs, and voltages on unit and heating wiring diagrams..

**TABLE 10
WALL THERMOSTAT AND SUBBASE COMBINATIONS**

Thermostat	Subbase	Predominant Features
8403-022 T87F3111	8403-003 Q539A1220	1 stage heat, 1 stage cool, Mercury System: Heat-off-cool Fan: on-auto
8403-041 T8034C1499	—	1 stage heat, 1 stage cool, Mercury System: Heat-off-cool Fan: on-auto
8403-049 1F93-380	—	2 stage heat, 2 stage cool, Electronic Programmable
8403-043 CM200	—	1 stage heat, 1 stage cool, Mercury System: Heat-off-cool Fan: on-auto Snap Action
8403-048 T8400C1313	—	1 stage heat, 1 stage cool, Mercury System: Heat-off-cool Fan: on-auto Electronic Non-Programmable
8403-019 T874C1760	8404-012 Q674C1760	1 stage heat, 1 stage cool, Mercury System: Heat-auto-cool Fan: on-auto

IMPORTANT NOTE: Only the thermostat and subbase combinations as shown above will work with this equipment. The thermostat and subbase **MUST** be matched, and correct operation can be assured only by proper selection and application of these parts.

**TABLE 9
THERMOSTAT WIRE SIZE**

Transformer VA	FLA	Wire Gauge	Maximum Distance In Feet
55	2.3	20	45
		18	60
		16	100
		14	160
		12	250

TRANSFORMER TAPS

230/208V, 1 phase and 3 phase equipment employ dual primary voltage transformers. All equipment leaves the factory wired on 240V tap. For 208V operation, reconnect from 240V to 208V tap. The acceptable operating voltage range for the 240 and 208V taps are:

TAP	RANGE
240	253 – 216
208	220 – 187

NOTE: The voltage should be measured at the field power connection point in the unit and while the unit is operating at full load (maximum amperage operating condition).

**FIGURE 9
LOW VOLTAGE WIRING**

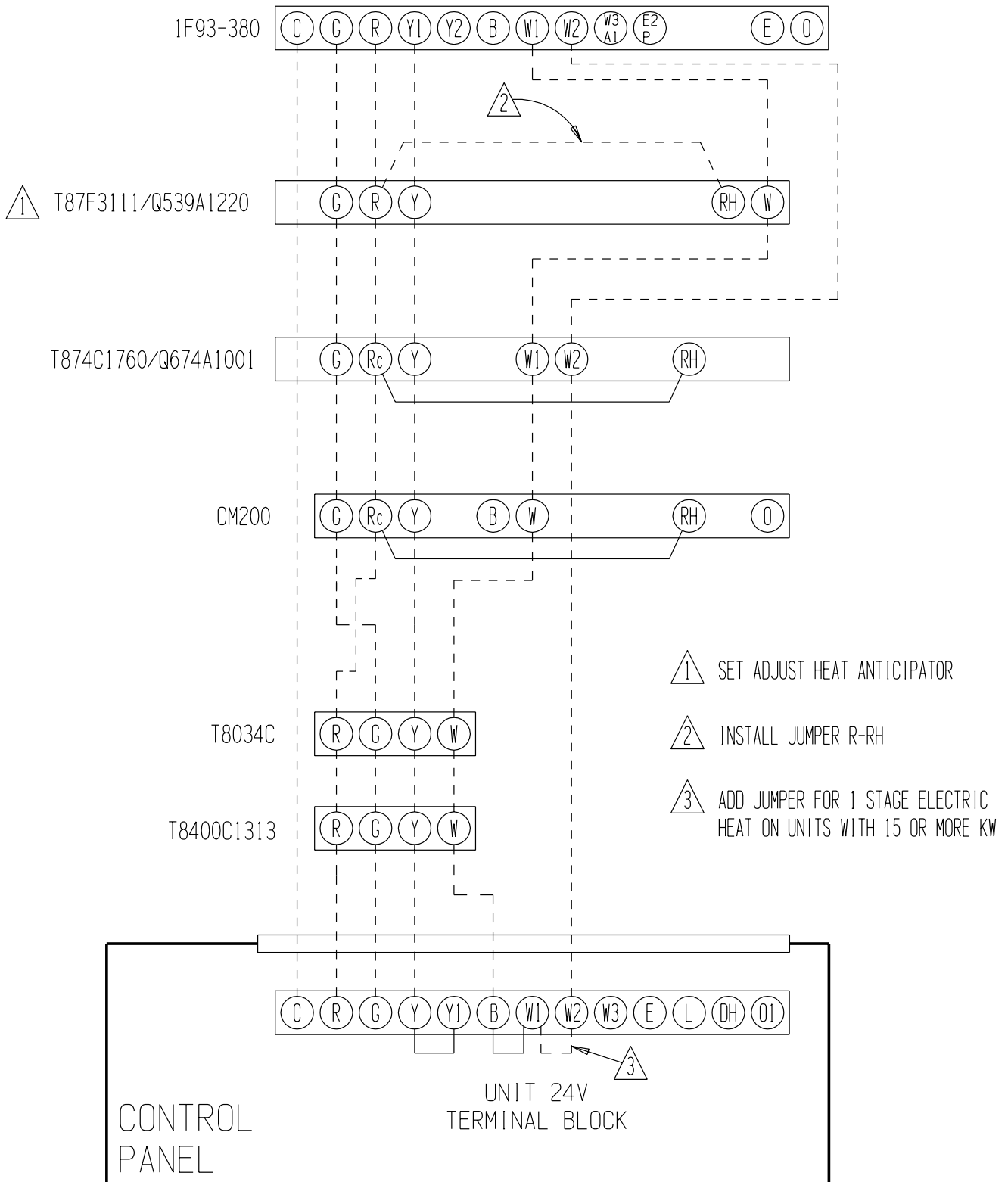

MIS-1180

START UP AND OPERATION

THREE PHASE SCROLL COMPRESSOR START UP INFORMATION

Scroll compressors, like several other types of compressors, will only compress in one rotational direction. Direction of rotation is not an issue with single phase compressors since they will always start and run in the proper direction.

However, three phase compressors will rotate in either direction depending upon phasing of the power. Since there is a 50-50 chance of connecting power in such a way as to cause rotation in the reverse direction, verification of proper rotation must be made. Verification of proper rotation direction is made by observing that suction pressure drops and discharge pressure rises when the compressor is energized. Reverse rotation also results in an elevated sound level over that with correct rotation, as well as, substantially reduced current draw compared to tabulated values.

Verification of proper rotation must be made at the time the equipment is put into service. If improper rotation is corrected at this time there will be no negative impact on the durability of the compressor. However, reverse operation for over one hour may have a negative impact on the bearing due to oil pump out.

NOTE: If compressor is allowed to run in reverse rotation for several minutes the compressor's internal protector will trip.

All three phase ZR*3 compressors are wired identically internally. As a result, once the correct phasing is determined for a specific system or installation, connecting properly phased power leads to the same Fusite terminals should maintain proper rotation direction.

The direction of rotation of the motor may be changed by reversing any two line connections to the unit.

SEQUENCE OF OPERATION

COOLING – Circuit R-Y makes at thermostat pulling in compressor contactor starting the compressor and outdoor motor. The G (indoor motor) circuit is automatically completed on any call for cooling operation, or can be energized by manual fan switch on subbase for constant air circulation.

HEATING – A circuit R-W1 is completed on each heating cycle energizing electric heat if so equipped.

START UP NOTES

For improved start up performance, wash the indoor coil with dishwasher detergent.

INDOOR BLOWER MOTOR

Some models feature a variable speed (ECM) motor providing high efficiency, low sound levels and soft start capabilities. The motor is self adjusting to provide the proper air flow rate at duct static pressures up to 0.50" WC without user adjustment or wiring changes.

On command from the wall thermostat the motor will start slowly and ramp up to full speed over a period of 10- 15 seconds.

When the thermostat is satisfied the blower will operate for approximately 1 minute, and then slow down and stop.

COMPRESSOR CONTROL MODULE

The compressor control is an anti-short cycle/lockout timer with high and low pressure switch monitoring and alarm output.

ADJUSTABLE DELAY-ON-MAKE AND BREAK TIMER

On a call for compressor operation the *delay-on-make* period begins which will be 10% of the *delay-on-break* setting. When the delay-on-make is complete and the high pressure switch (and low pressure switch if employed) is closed, the compressor contactor is energized. Upon shutdown the delay-on-break timer starts and prevents restart until the delay-on-break and delay-on-make periods have expired.

HIGH PRESSURE SWITCH AND LOCKOUT SEQUENCE (Standard Feature)

If the high pressure switch opens, the compressor contactor will de-energize immediately. The lockout timer will go into a *soft lockout* and stay in soft lockout until the high pressure switch closes **and** the delay-on-make time has expired. If the high pressure switch opens again in this same operating cycle the unit will go into *manual lockout* condition and the alarm circuit will energize. Recycling the wall thermostat resets the manual lockout.

LOW PRESSURE SWITCH, BYPASS, AND LOCKOUT SEQUENCE

NOTE: The low pressure switch is an optional control and the bypass and lockout sequence are part of the standard compressor control module.

If the low pressure switch opens for more than 120 seconds, the compressor contactor will de-energize and go into a soft lockout. Regardless the state of the low pressure switch, the contactor will reenergize after the delay-on-make time delay has expired. If the low pressure switch remains open or opens again for longer than 120 seconds the unit will go into manual lockout condition and the alarm circuit will energize. Recycling the wall thermostat resets the manual lockout.

ALARM OUTPUT

Alarm terminal is output connection for applications where alarm signal is desired. This terminal is powered whenever compressor is locked out due to HPC or LPC sequences as described.

NOTE: Both high and low pressure switch controls are inherently automatic reset devices. The high pressure switch and low pressure switch cut out and cut in settings are fixed by specific air conditioner or heat pump unit model. The lockout features, both soft and manual, are a function of the Compressor Control Module.

ADJUSTMENTS

ADJUSTABLE DELAY-ON-MAKE AND DELAY-ON-BREAK TIMER

The potentiometer is used to select Delay-on-Break time from 30 seconds to 5 minutes. Delay-on-Make (DOM) timing on power-up and after power interruptions is equal to 2 minutes plus 10% of Delay-on-Break (DOB) setting:

0.5 minute (30 seconds)	DOB = 123 second	DOM
1.0 minute (60 seconds)	DOB = 126 second	DOM
2.0 minute (120 seconds)	DOB = 132 second	DOM
3.0 minute (160 seconds)	DOB = 138 second	DOM
4.0 minute (240 seconds)	DOB = 144 second	DOM
5.0 minute (300 seconds)	DOB = 150 second	DOM

SERVICE AND TROUBLESHOOTING

SERVICE HINTS

1. Caution homeowner to maintain clean air filters at all times. Also, not to needlessly close off supply and return air registers. This reduces air flow through the system which shortens equipment service life as well as increasing operating costs.
2. Check all power fuses or circuit breakers to be sure that they are the correct rating.
3. Periodic cleaning of the outdoor coil to permit full and unrestricted airflow circulation is essential.

PRESSURE SERVICE PORTS

High and low pressure service ports are installed on all units so that the system operating pressures can be observed. Pressure tables can be found later in this manual covering all models on cooling cycle. It is imperative to match the correct pressure table to the unit by model number.

REFRIGERANT CHARGE

The correct system R-22 charge is shown on the unit rating plate. Optimum unit performance will occur with a refrigerant charge resulting in a suction line temperature (6" from compressor) as shown in Table 11.

**TABLE 11
SUCTION LINE TEMPERATURES**

Model	Rated Airflow	95° OD Temperature	82° OD Temperature
P1124A2	800	56 - 58	63 - 65
P1224A1	800	56 - 58	63 - 65
P1130A2	1125	56 - 58	63 - 65
P1230A1	1000	56 - 58	63 - 65
P1136A2	1250	57 - 59	58 - 60
P1236A1	1100	57 - 59	58 - 60
P1142A3	1400	57 - 59	58 - 60
P1242A1	1400	57 - 59	58 - 60
P1148A2	1550	54 - 57	58 - 60
P1248A2	1550	53 - 55	56 - 58
P1060A1	1700	47 - 49	54 - 56

The above suction line temperatures are based upon 80°F dry bulb/67°F wet bulb (50% RH) temperature and rated airflow across the evaporator during cooling cycle.

FAN BLADE SETTINGS

Shown in Figure 10 are the correct fan blade setting dimensions for proper air delivery across the outdoor coil.

Any service work requiring removal or adjustment in the fan and/or motor area will require that the dimensions below be checked and blade adjusted in or out on the motor shaft accordingly.

**FIGURE 10
FAN BLADE SETTING**

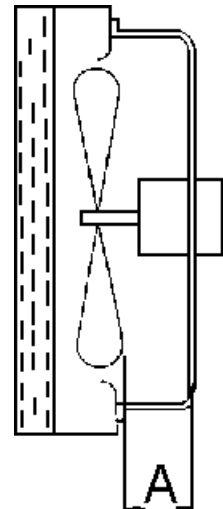

**TABLE 12
FAN BLADE SETTING DIMENSIONS**

Model	Dimension "A"
P1124A2	1.00"
P1224A1	1.00"
P1130A2	.75"
P1230A1	1.00"
P1136A2	1.00"
P1236A1	1.00"
P1142A3	1.75"
P1242A1	1.75"
P1148A2	1.75"
P1248A2	1.75"
P1060A1	1.75"

SUCTION AND DISCHARGE TUBE BRAZING

Compliant Scroll compressors have copper plated steel suction and discharge tubes. These tubes are far more rugged and less prone to leaks than copper tubes used on other compressors. Due to different thermal properties of steel and copper, brazing procedures may have to be changed from those commonly used.

- To disconnect: heat joint Areas 2 and 3 slowly and uniformly until braze material softens and the tube can be pulled out of suction fitting. (See Figure 10.)
- To connect:
 - Recommended brazing materials: silfos with minimum 5% silver or silver braze material with flux.

- Reinsert tube into fitting.
- Heat tube uniformly in Area 1 moving slowly to Area 2. When joint reaches brazing temperature, apply brazing material. (See Figure 11)
- Heat joint uniformly around the circumference to flow braze material completely around the joint.
- Slowly move torch into Area 3 to draw braze material into joint. (See Figure 11.)
- **Do not** overheat joint.

**FIGURE 11
BRAZING DIAGRAM**

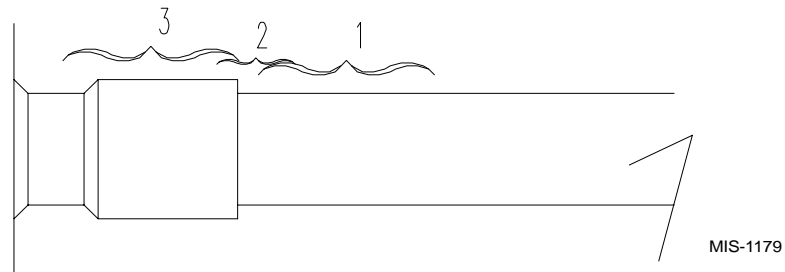

**TABLE 13
INDOOR BLOWER PERFORMANCE**

ESP In H ₂ O	P1124A2	P1130A2	P1136A2	P1142A3	P1148A2	P1060A1
	Dry / Wet	Dry / Wet	Dry / Wet	Dry / Wet	Dry / Wet	Dry / Wet
0.0	1025 / 960	1350 / 1210	1465 / 1375	1650 / 1625	1950 / 1920	1850 / 1850
0.1	935 / 870	1300 / 1160	1430 / 1340	1550 / 1525	1860 / 1830	1800 / 1780
0.2	865 / 800	1240 / 1100	1385 / 1295	1435 / 1400	1780 / 1750	1725 / 1700
0.3	835 / 770	1175 / 1035	1340 / 1250	1340 / 1310	1680 / 1660	1660 / 1625
0.4	800 / 735	1120 / 980	1275 / 1185	1230 / 1210	1580 / 1550	1580 / 1540
0.5	750 / 685	1050 / 910	1190 / 1100	1120 / 1100	1500 / 1480	1500 / 1475

**TABLE 14
PRESSURE TABLE**

COOLING

Air Temperature Entering Outdoor Coil Degrees F

Model	Return Air Temperature	Pressure	75	80	85	90	95	100	105	110	115
P1124A2	75 deg. DB 62 deg. WB	Low Side High Side	70 219	74 220	77 224	79 234	80 248	82 258	83 276	84 293	85 316
	80 deg. DB 67 deg. WB	Low Side High Side	75 224	79 225	82 230	84 240	86 254	88 265	89 283	90 300	91 324
	85 deg. DB 72 deg. WB	Low Side High Side	81 232	85 233	88 238	90 248	92 263	94 274	96 293	97 311	98 335
P1224A1	75 deg. DB 62 deg. WB	Low Side High Side	74 188	75 203	77 217	79 233	79 249	80 265	81 282	82 299	83 317
	80 deg. DB 67 deg. WB	Low Side High Side	79 193	80 208	82 223	84 239	85 255	86 272	87 289	88 307	89 325
	85 deg. DB 72 deg. WB	Low Side High Side	82 200	83 215	85 231	87 247	88 264	89 282	90 299	91 318	92 336
P1130A2	75 deg. DB 62 deg. WB	Low Side High Side	73 200	75 219	76 234	77 254	79 271	80 288	81 307	82 327	83 342
	80 deg. DB 67 deg. WB	Low Side High Side	75 205	80 225	81 240	82 260	84 278	85 295	86 315	87 335	88 351
	85 deg. DB 72 deg. WB	Low Side High Side	84 212	86 233	87 248	88 269	90 287	91 305	92 326	94 347	95 363
P1230A1	75 deg. DB 62 deg. WB	Low Side High Side	72 199	73 213	74 227	75 243	77 258	78 275	79 293	79 310	80 330
	80 deg. DB 67 deg. WB	Low Side High Side	77 204	78 218	79 233	80 249	82 265	83 282	84 300	85 318	86 338
	85 deg. DB 72 deg. WB	Low Side High Side	80 211	81 226	82 241	83 258	85 274	86 292	87 311	88 329	89 350
P1136A2	75 deg. DB 62 deg. WB	Low Side High Side	67 195	71 215	73 229	75 249	77 263	78 282	79 302	80 317	81 336
	80 deg. DB 67 deg. WB	Low Side High Side	72 200	76 220	78 235	80 255	82 270	84 290	85 310	86 325	87 345
	85 deg. DB 72 deg. WB	Low Side High Side	77 207	82 228	84 243	86 264	88 279	90 300	91 321	92 336	94 357
P1236A1	75 deg. DB 62 deg. WB	Low Side High Side	71 209	73 225	75 242	76 258	78 275	79 293	79 310	80 329	81 346
	80 deg. DB 67 deg. WB	Low Side High Side	76 214	78 231	80 248	81 265	83 282	84 300	85 318	86 337	87 355
	85 deg. DB 72 deg. WB	Low Side High Side	79 221	81 239	83 257	84 274	86 292	87 311	88 329	89 349	90 367

(Continued on Page 22 in Table 14A)

**TABLE 14A
PRESSURE TABLE**

COOLING

Air Temperature Entering Outdoor Coil Degrees F

Model	Return Air Temperature	Pressure	75	80	85	90	95	100	105	110	115
P1142A3	75 deg. DB 62 deg. WB	Low Side High Side	70 208	72 223	75 239	77 254	78 271	79 288	80 305	81 324	82 342
	80 deg. DB 67 deg. WB	Low Side High Side	75 213	77 229	80 245	82 261	84 278	85 295	96 313	87 332	88 351
	85 deg. DB 72 deg. WB	Low Side High Side	81 220	83 237	86 254	88 270	0 288	91 305	92 324	94 344	95 363
P1242A1	75 deg. DB 62 deg. WB	Low Side High Side	70 192	72 206	74 220	76 236	78 252	79 268	80 286	81 304	82 323
	80 deg. DB 67 deg. WB	Low Side High Side	75 197	77 211	79 226	81 242	83 258	85 275	86 293	87 312	88 331
	85 deg. DB 72 deg. WB	Low Side High Side	78 204	80 218	82 234	84 250	86 267	88 285	89 303	90 323	91 343
P1148A2	75 deg. DB 62 deg. WB	Low Side High Side	73 203	74 218	75 231	76 246	78 264	79 278	80 294	81 312	82 330
	80 deg. DB 67 deg. WB	Low Side High Side	78 208	79 222	81 237	82 252	83 268	84 285	86 302	87 320	88 338
	85 deg. DB 72 deg. WB	Low Side High Side	83 215	85 230	87 245	88 261	87 273	91 295	92 313	93 331	94 350
P1248A2	75 deg. DB 62 deg. WB	Low Side High Side	70 200	72 215	73 230	75 247	77 263	79 281	79 298	81 317	83 336
	80 deg. DB 67 deg. WB	Low Side High Side	75 205	77 220	78 236	80 253	82 270	84 288	85 306	87 325	89 345
	85 deg. DB 72 deg. WB	Low Side High Side	78 212	80 228	81 244	83 262	85 279	87 298	88 317	90 336	92 357
P1060A1	75 deg. DB 62 deg. WB	Low Side High Side	65 214	66 230	68 247	69 264	70 284	72 299	74 318	75 336	76 355
	80 deg. DB 67 deg. WB	Low Side High Side	69 219	71 236	72 253	74 271	76 289	77 307	79 326	80 345	82 364
	85 deg. DB 72 deg. WB	Low Side High Side	74 227	76 244	78 262	79 280	81 296	83 318	85 337	86 357	88 377

TROUBLESHOOTING ECM BLOWER MOTORS



CAUTION

Disconnect power from unit before removing or replacing connectors, or servicing motor. Wait at least 5 minutes after disconnection power before opening motor.

SYMPTOM

Motor rocks slightly when starting.

Motor won't start

- No movement

- Motor rocks, but won't start

Motor oscillates up and down while being tested off of blower

- Noisy blower of cabinet

- "Hunts" or "puffs" at high CFM (speed)

Evidence of Moisture

- Motor failure or malfunction has occurred and moisture is present
- Evidence of moisture present inside air mover

DO

- Check out motor, controls, wiring and connections thoroughly before replacing motor
- Orient connectors down so water can't get in; install "drip loops"
- Use authorized motor and control model numbers for replacement
- Keep static pressure to a minimum:
 - Recommend high efficiency, low static filters
 - Recommend keeping filters clean
 - Design duct work for minimum static, maximum comfort
 - Look for and recommend duct work improvement, where necessary, in replacement.

CAUSE / PROCEDURE

- This is normal start-up for ICM
- Check power at motor
- Check low voltage (24 VAC R to C) at motor
- Check low voltage connections (G, Y, W, R, C) at motor
- Check for unseated pins in connectors on motor harness
- Test with a temporary jumper between R - G
- Check motor for tight shaft
- Run **Moisture Check**
- Check for loose or compliant motor mount
- Make sure blower wheel is tight on shaft
- It is normal for motor to oscillate with no load on shaft.
- Check for loose blower housing, panels, etc.
- High static creating high blower speed?
 - Check for air whistling through seams in ducts, cabinets or panels.
 - Check for cabinet / duct deformation
- Does removing panel or filter reduce "puffing"?
 - Reduce restriction
 - Reduce maximum airflow

- Replace motor and perform **Moisture Check**

- Perform Moisture Check

DONT

- Automatically assume the motor is bad
- Locate connectors above 7 and 4 o'clock positions
- Replace one motor or control model number with another (unless an authorized replacement)
- Use high pressure drop filters. Some have 1/2" H₂O drop!
- Use restricted returns

SYMPTOM

Motor starts but runs erratically

- Varies up and down or intermittent
- "Hunts" or puffs" at high CRM (speed)
- Stays at low CFM despite system call for cool or heat CFM
- Stays at high CFM
- Blower won't shut off

SYMPTOM

Excessive noise

- Air Noise

DO

- Size the equipment wisely
- Check orientation before inserting motor connectors

MOISTURE CHECK PROCEDURE

- Connectors are oriented "down"
- Arrange harnesses with "drip loop" under motor
- Condensate drain plugged?
- Check for low airflow (too much latent capacity)
- Check for undercharged condition
- Check and plug leaks in return ducts and cabinet

CAUSE / PROCEDURE

- Check line voltage for variation or "sag"
- Check low voltage connections (G, Y, W, R, C) at motor; unseated pins in motor harness connectors
- Check "Bk" for erratic CFM command (in variable speed applications)
- Check out system controls - thermostat?
- Perform **Moisture Check**
- Does removing panel or filter reduce "puffing"?
 - Reduce restriction
 - Reduce maximum airflow
- Check low voltage (thermostat) wires and connections
- Verify fan is not in delay mode - wait until delay is complete
- "R" missing / not connected at motor
Perform motor / control replacement check
- "R" missing / not connected at motor
- Is fan in delay mode? - wait until delay time complete
- Current leakage from controls into G, Y or W?
 - Check for Triac switched thermostat or solid state relay

CAUSE / PROCEDURE

- Determine if it is air noise, cabinet, duct or motor noise . Interview customer if necessary.
- High static creating high blower speed?
 - Is airflow set properly?
 - Does removing filter cause blower to slow down?
Check / replace filter
 - Use low pressure drop filter
 - Check / correct duct restrictions

DONT

- Oversize system then compensate with low airflow
- Plug in power connector backwards
- Force plugs

COMFORT CHECK PROCEDURE

- Check proper airflow settings
- Low static pressure for lowest noise
- Set low continuous fan CFM
- Use humidistat and 2-speed cooling units
- Use zoning controls designed for ICM that regulate CFM
- Thermostat in bad location?

Free Manuals Download Website

<http://myh66.com>

<http://usermanuals.us>

<http://www.somanuals.com>

<http://www.4manuals.cc>

<http://www.manual-lib.com>

<http://www.404manual.com>

<http://www.luxmanual.com>

<http://aubethermostatmanual.com>

Golf course search by state

<http://golfingnear.com>

Email search by domain

<http://emailbydomain.com>

Auto manuals search

<http://auto.somanuals.com>

TV manuals search

<http://tv.somanuals.com>