

Installation and Operating Guide

DS9000 Series



 Advanced Digital Information Corp

Copyright Notice

© Copyright ADIC 1995, 1996, 1997, 1998, 1999, 2000, 2001

The information contained in this document is subject to change without notice.

This document contains proprietary information that is protected by copyright. All rights are reserved. No part of this document may be photocopied, reproduced or translated to another language without the prior written consent of ADIC.

ADIC shall not be liable for errors contained herein or for incidental or consequential damages (including lost profits) in connection with the furnishing, performance or use of this material whether based on warranty, contract, or other legal theory.

Printed in the U.S.A.

April 2001

Document Number 62-0101-01 Rev. H

Advanced Digital Information Corporation

Telephone: (425) 881-8004

Fax: (425) 881-2296

World-Wide Web: <http://www.adic.com>

Shipping Address: 11431 Willows Road NE
Redmond, WA 98052

Mailing Address: P.O. Box 97057
Redmond, WA 98073-9757

ADIC Europe
ZAC des Basses Auges
1, rue Alfred de Vigny
78112 - Fourqueux, FRANCE
Telephone: +33 (0)1 30 87 53 00
Fax: +33 (0)1 30 87 53 01

For Customer Assistance:

In the United States and Canada, call ADIC Technical Assistance Center (ATAC)
at (800) 827-3822

In Europe, call ADIC Technical Assistance Center (ATAC) at +800.9999.3822

ADIC™ and ADIC Europe™ are trademarks of Advanced Digital Information Corporation. Quantum® is a registered trademark, DLT™ and DLTTape™ are trademarks of Quantum Corporation.

Copyright Notice (Europe)

© Copyright ADIC Europe 1995, 1996, 1997, 1998, 1999, 2000, 2001

All rights reserved. No part of this document may be copied or reproduced in any form or by any means, without prior written permission of ADIC Europe, ZAC des Basses Auges 1, rue Alfred de Vigny 78112 - Fourqueux, FRANCE.

ADIC Europe assumes no responsibility for any errors that may appear in this document, and retains the right to make changes to these specifications and descriptions at any time, without notice.

This publication may describe designs for which patents are pending, or have been granted. By publishing this information, ADIC Europe conveys no license under any patent or any other right.

ADIC Europe makes no representation or warranty with respect to the contents of this document and specifically disclaims any implied warranties of merchantability or fitness for any particular purpose. Further, ADIC Europe reserves the right to revise or change this publication without obligation on the part of ADIC Europe to notify any person or organization of such revision or change.

Every effort has been made to acknowledge trademarks and their owners. Trademarked names are used solely for identification or exemplary purposes, any omissions are made unintentionally.

Blank Page

Regulatory Notices

FCC Notices (USA Only)

This equipment generates, uses, and can radiate radio frequency energy and, if not installed and used in accordance with the manufacturer's instruction manual, may cause interference with radio and television reception. This equipment has been tested and found to comply with the limits for a Class B digital device, pursuant to Part 15 of the FCC Rules. These limits are designed to provide reasonable protection against harmful interference in a residential installation. However, there is no guarantee that interference will not occur in a particular installation. If this equipment does cause harmful interference with radio or television reception, which can be determined by turning the equipment off and on, you are encouraged to try to correct the interference by one or more of the following measures:

Reorient the receiving antenna.

Relocate the equipment with respect to the receiver.

Move the equipment away from the receiver.

Plug the equipment into a different outlet so that the equipment and the receiver are on different branch circuits.

If necessary, consult a representative of ADIC or an experienced radio/television technician for additional suggestions. You may find the following booklet helpful: FCC Interference Handbook, 1996, available from the U.S. Government Printing Office, Washington, DC 20402, Stock No. 004-000-00450-7.

This device complies with Part 15 of the FCC rules. Operation is subject to the following two conditions:

This device may not cause harmful interference.

This device must accept any interference received, including interference that may cause undesired operation.

A Notice About Shielded Cables: Use only shielded cables for connecting peripherals to this device to reduce the possibility of interference with radio and television reception. Using shielded cables ensures that you maintain the appropriate FCC radio frequency emissions compliance (for a Class A device) or FCC certification (for a Class B device) of this product.

The following information is provided on the device or devices covered in this document in compliance with FCC regulations:

Product Name: DS9000 Series
Model number: DS9X00
Company name: Advanced Digital Information Corporation
PO Box 97057
Redmond, WA 98073-9757 USA
(425) 881-8004

IC Notice (Canada Only)

Most tape libraries are classified by the Industry Canada (IC) Interference-Causing Equipment Standard #3 (ICES-003) as Class B digital devices. To determine which classification (Class A or B) applies to your tape library, examine all registration labels located on the bottom or the back panel of your library. A statement in the form of "IC Class A ICES-3" or "IC Class B ICES-3" will be located on one of these labels.

Note that Industry Canada regulations provide that changes or modifications not expressly approved by the tape library manufacturer could void your authority to operate this equipment.

This Class B (or Class A, if so indicated on the registration label) digital apparatus meets the requirements of the Canadian Interference-Causing Equipment Regulations.

Cet appareil numérique de la Classe B (ou Classe A, si ainsi indiqué sur l'étiquette d'enregistrement) respecte toutes les exigences du Règlement sur le Matériel Brouilleur du Canada.

EN 55022 Compliance (Czech Republic Only)

This device belongs to category B devices as described in EN 55022, unless it is specifically stated that it is a category A device on the specification label. The following applies to devices in category A of EN 55022 (radius of protection up to 30 meters). The user of the device is obliged to take all steps necessary to remove sources of interference to telecommunication or other devices.

Pokud není na typovém štítku pořízeno uvedeno, že spadá do třídy A podle EN 55022, spadá automaticky do třídy B podle EN 55022. Pro zařazení zařízení do třídy A (ochranné pásmo 30m) podle EN 55022 platí následující. Dojde-li k rušení telekomunikačních nebo jiných zařízení, je uživatel povinen provést taková opatření, aby rušení odstranil.

CE Notice

Marking by the symbol **CE** indicates compliance of this tape library to the EMC (Electromagnetic Compatibility) directive of the European Community. Such marking is indicative that this tape library meets or exceeds the following technical standards:

EN 55022 — "Limits and Methods of Measurement of Radio Interference Characteristics of Information Technology Equipment." This system is an EN 55022 Class B device.

EN 50081-1 — "Electromagnetic compatibility—Generic emission standard Part 1: Residential, commercial, and light industry."

EN 50082-1:1997 — "Electromagnetic compatibility—Generic immunity standard Part 1: Residential, commercial, and light industry."

EN 61000-3-2 — "Harmonic current emissions test." — Device Class A.

EN 61000-3-3 — "Voltage fluctuations and flicker in low-voltage supply systems test."

EN 61000-4-2 — "Electrostatic discharge immunity test." — Severity level 3.

EN 61000-4-3 — "Radiated, radio-frequency, electromagnetic field immunity test." — Severity level 2.

EN 61000-4-4 — "Electrical fast transient/burst immunity test." — Severity level 2.

EN 61000-4-5 — "Surge immunity test." — Severity level 2.

EN 61000-4-6 — “Immunity to conducted disturbances, induced by radio-frequency fields.” — Severity level 2.

EN 61000-4-8 — “Power frequency magnetic field immunity test.” — Severity level 2.

EN 61000-4-11 — “Voltage dips, short interruptions and voltage variations immunity test.” — Performance criteria B and C.

ENV 50204 — “Radiated electromagnetic field from digital radio telephones.”

EN 60950:1992 + Amd.1:1993 + Amd.2:1993 with considerations to Amd.3:1995 — “Safety of Information Technology Equipment including Electrical Business Equipment.”

A “Declaration of Conformity” in accordance with the preceding standards has been made and is on file at ADIC Europe, ZAC de Basses Auges, 1, rue Alfred de Vigny, 78112 Fourqueux, FRANCE.

DECLARATION OF CONFORMITY

according to EN 45014

Manufacturer's Name: Advanced Digital Information Corporation

Manufacturer's Address: 11431 Willows Road ZAC des Basses Auges
Redmond, Washington 98052 1, rue Alfred de Vigny
USA 78112 Fourqueux,
FRANCE

declares, that the product:

**Product
(Produit, Erzeugnis):** DS9000 Series

**Model Numbers
(Marque Commercial,
Warenbezeichnung):** DS9800D
DS9700D
DS9400D/L
DS9400

conforms to the following international standards,

Emissions: EN 50081-1, EN-55022 Class B

Immunity: EN 50082-1

Safety: EN 60950

Quality: ISO 9001

Supplementary Information:

Signature: Signature on File _____

Signature: Signature on File _____

Full Name: _____

Full Name: _____

Position: _____

Position: _____

Date: _____

Date: _____

Place: Redmond, WA USA

Place: Fourqueux, FRANCE

Safety Notices

Warnings

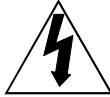

This symbol should alert the user to the presence of "dangerous voltage" inside the product that might cause harm or electric shock.

CAUTION

**RISK OF ELECTRIC SHOCK
DO NOT OPEN**

CAUTION : TO REDUCE THE RISK OF ELECTRIC SHOCK, DO NOT REMOVE COVER (OR BACK). NO USER-SERVICEABLE PARTS INSIDE. REFER SERVICING TO QUALIFIED SERVICE PERSONNEL.

Caution

All safety and operating instructions should be read before this product is operated, and should be retained for future reference. This unit has been engineered and manufactured to assure your personal safety. Improper use can result in potential electrical shock or fire hazards. In order not to defeat the safeguards, observe the following basic rules for its installation, use and servicing.

- Heed Warnings - All warnings on the product and in the operating instructions should be adhered to.
- Follow Instructions - All operating and use instructions should be followed.
- Ventilation - The product should be situated so that its location or position does not interfere with proper ventilation.
- Heat - The product should be situated away from heat sources such as radiators, heat registers, furnaces, or other heat producing appliances.
- Power Sources - The product should be connected to a power source only of the type directed in the operating instructions or as marked on the product.
- Power Cord Protection - The AC line cord should be routed so that it is not likely to be walked on or pinched by items placed upon or against it, paying particular attention to the cord at the wall receptacle, and the point where the cord exits from the product.
- Object and Liquid Entry - Care should be taken to insure that objects do not fall and liquids are not spilled into the product's enclosure through openings.
- Servicing - The user should not attempt to service the product beyond that described in the operating instructions. All other servicing should be referred to qualified service personnel.

Precautions

- Do not use oil, solvents, gasoline, paint thinners or insecticides on the unit.
- Do not expose the unit to moisture, to temperatures higher than 60°C (140°F) or to extreme low temperatures.
- Keep the unit away from direct sunlight, strong magnetic fields, excessive dust, humidity and electronic/electrical equipment, which generate electrical noise.
- Hold the AC power plug by the head when removing it from the AC source outlet; pulling the cord can damage the internal wires.
- Use the unit on a firm level surface free from vibration, and do not place anything on top of unit.

Table of Contents

Copyright Notice	ii
Copyright Notice (Europe).....	iii
Regulatory Notices.....	v
Safety Notices	ix
Chapter 1 Introduction	1
Equipment Description.....	2
DLT Drives	2
Options.....	2
SCSI Interface	2
Front Panel Controls and Indicators.....	3
Rear Panel Controls and Connectors.....	7
Data Cartridge	8
Other Requirements	9
Application Software	9
Chapter 2 Installation.....	11
Unpacking and Inspecting.....	12
Checking the Accessories.....	12
Installing the Host Adapter	12
Connecting the Interface Cable	12
Connecting More than One DS9000 Series Unit	13
Setting the SCSI ID.....	14
Check the SCSI Bus Termination	15
Connecting Power and Turning On.....	15
Installing the Application Software.....	16
Chapter 3 Operation and Maintenance.....	17
Power-on Self-Test.....	18
Drive Status.....	18
Loading the Data Cartridge	25
Data Protection.....	27
Tape in Use	27
Removing the Data Cartridge.....	28
Cleaning the Tape Head	28
Cleaning the Enclosure	30
Chapter 4 Troubleshooting and Diagnostics	31
Troubleshooting Chart	32
Use Cleaning Tape LED.....	34

Why the Use Cleaning Tape LED Gets Turned ON.....	34
High Humidity	35
When Assistance is Required.....	36
Calling ADIC’s Technical Assistance Center (ATAC).....	36
Appendix A Specifications	37
Appendix B Drive Configuration.....	39
Index	45

Chapter 1

Introduction

This Chapter. . .

- ❑ provides a physical description of the switches, indicators and connectors on the front and rear panels of the DS9000 Series.
- ❑ describes other requirements (additional hardware and software) needed to use the DS9000 Series devices.

Equipment Description

The ADIC DS9000 Series consists of several models: the ADIC 4000, DS9400D/L, DS9700D and DS9800D. All are SCSI compatible, high performance, streaming tape cartridge devices designed for storage of near-line and off-line data.

The DS9400D/L, DS9700D, and DS9800D are equipped with a 2-line by 20-character, back-lit LCD display. The LCD displays drive status messages, error messages, and drive Power-On Self-Test (POST) results messages. The ADIC 4000 uses the drive bezel LEDs to communicate drive operations. The DS9000 Series also includes Flash EEPROM technology that allows easy on-site installation of firmware updates from tape or from the host.

DLT Drives

Your DS9000 Series is equipped with a third-, or fourth-generation DLT drive. The DLT4000 and DLT7000 drives can read and write 2.6 GB, 6.0 GB, and 10.0 GB tape formats for 100% interchange compatibility with earlier DLT drives. The DLT 8000 drive can read and write 10.0, 15.0, 20.0, and 35.0 GB tape formats for 100% interchange compatibility with the DLT 2000, DLT 2000xt, DLT 4000, and DLT 7000 drives. DLT 8000 default tape density is 40 GB (80 GB compressed) when using the DLTape IV data cartridge. Tape density is selectable by the application software or via the Operator Panel.

Model	Drive Model	Cartridge Max Capacity (density - compressed mode)	Sustained Transfer Rate (compressed mode)
DS9400D/L ADIC 4000	DLT4000	20 GB (DLTTape III) 30 GB (DLTTape IIIXT) 40 GB (DLTTape IV)	3.0 MB/sec (180 MB/min)
DS9700D	DLT7000	20 GB (DLTTape III) 30 GB (DLTTape IIIXT) 70 GB (DLTTape IV)	10.0 MB/sec (600 MB/min)
DS9800D	DLT8000	20 GB (DLTTape III) 30 GB (DLTTape IIIXT) 80 GB (DLTTape IV)	12.0 MB/sec (720 MB/min)

Maximum Capacity and Sustained Transfer Rates

Options

SCSI Interface

The DS9000 Series is available with several different SCSI interfaces. These include Single-Ended (SE), Low Voltage Differential/Single-Ended (LVD/SE), or High Voltage Differential (HVD) SCSI interface.

Caution

SE and LVD/SE SCSI devices are not compatible with HVD SCSI devices. Equipment damage may occur if you connect your DS9000 Series unit to an incompatible SCSI bus.

Front Panel Controls and Indicators

Figures 1 through 3 show the controls and indicators located on the front panel of the DS9000 Series.

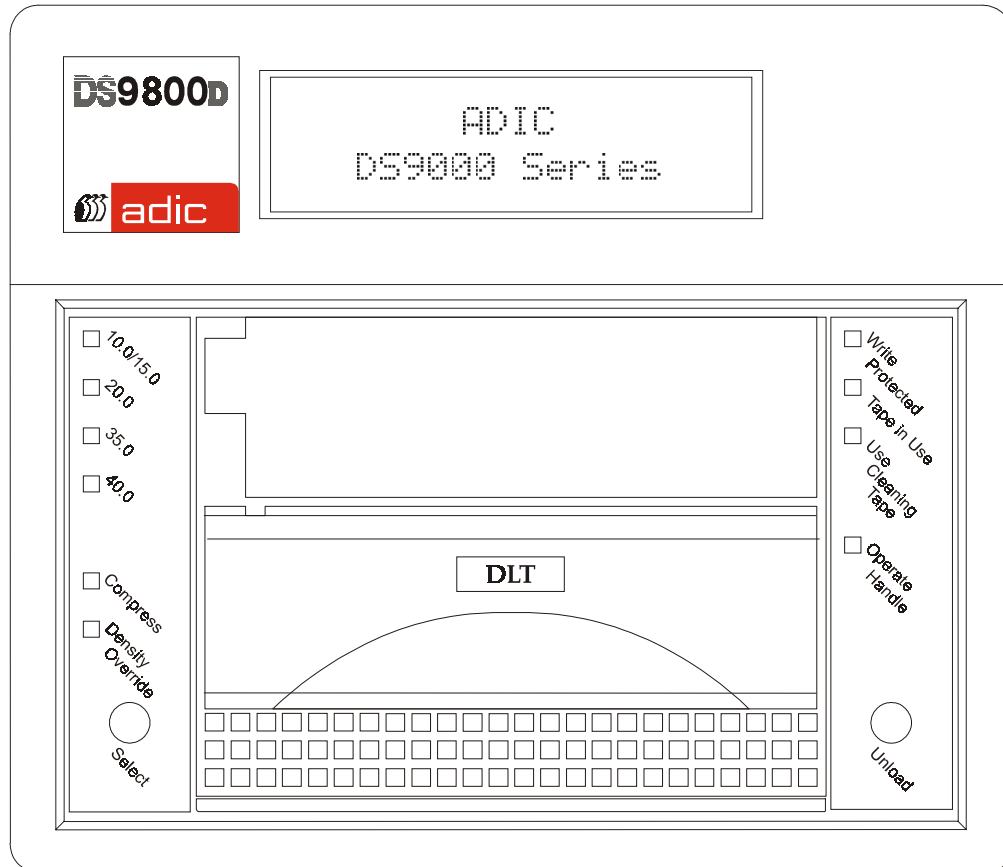

Figure 1. DS9800D Front Panel

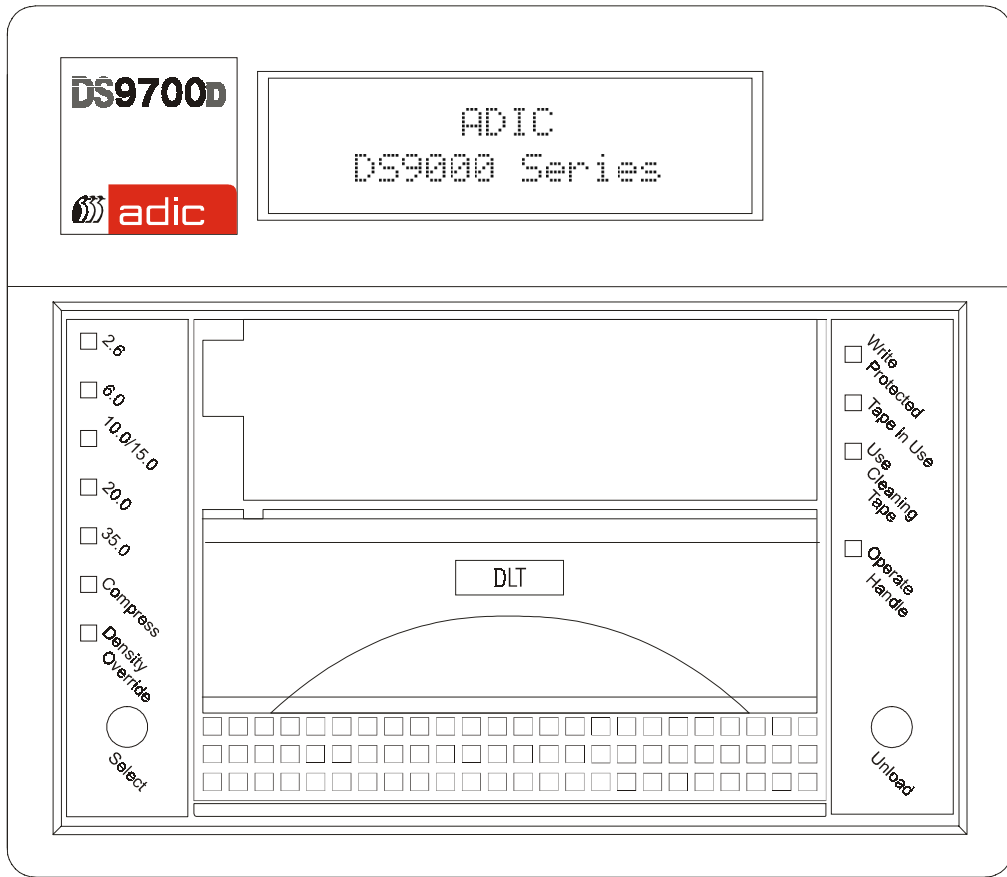

Figure 2. DS9700D Front Panel

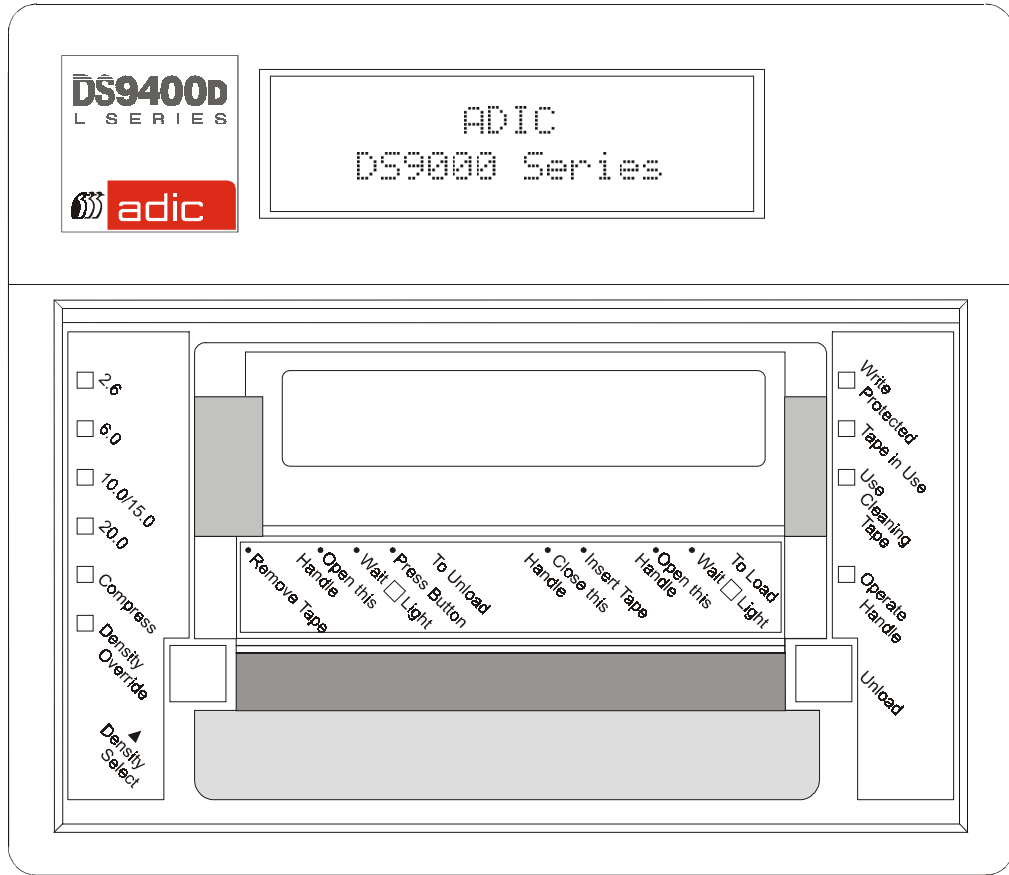

Figure 3. DS9400D/L Front Panel (ADIC 4000 does not include the LCD)

Front Panel Indicators and Controls	
2-line by 20-character LCD Display	Displays drive status, error messages, POST results
Beeper	Sounds whenever it is OK to operate the cartridge insert/release handle. The green Operate Handle LED should be ON whenever the Beeper sounds.
Write Protected (orange)	ON = Tape write-protected. OFF = Tape write enabled.
Tape in Use (yellow)	Blinking = Tape moving. ON = Tape loaded; ready for use.
Use Cleaning Tape (yellow)	ON = Drive head needs cleaning, or the tape is bad. OFF = cleaning complete, or cleaning unnecessary.
Operate Handle (green)	ON = OK to operate the cartridge insert/release handle. OFF = Do not operate the cartridge insert/release handle.
Density Select 2.6 (yellow)	ON = Tape is recorded in 2.6 GB format. Blinking = Tape is recorded in another density.
Density Select 6.0 (yellow)	ON = Tape is recorded in 6.0 GB format. Blinking = Tape is recorded in another density.
Density Select 10.0 (yellow)	ON = Tape is recorded in 10.0 GB format. Blinking = Tape is recorded in another density.
Density Select 15.0 (yellow)	ON = Tape is recorded in 15.0 GB format. Blinking = Tape is recorded in another density.
Density Select 20.0 (yellow) [DS9400D/L, ADIC 4000]	ON = Tape is recorded in 20.0 GB format. Blinking = Tape is recorded in another density.
Density Select 35.0 (yellow) [DS9700D]	ON = Tape is recorded in 35.0 GB format. Blinking = Tape is recorded in another density.
Density Select 40.0 (yellow) [DS9800D]	ON = Tape is recorded in 40.0 GB format. Blinking = Tape is recorded in another density.
Compress (yellow)	ON = Compression mode enabled. OFF = Compression mode disabled.
Density Override (yellow)	ON = Density selected from front panel. OFF (default) = Density selected from host. Blinking = In density selection mode.
Unload Button	Pressing this button initiates a manual unload of the tape. This may take from 10 seconds to 4 minutes depending on tape position.
Cartridge Insert/Release Handle	Lift this handle (only when the Operate Handle LED is ON , and after the momentary beep sounds) to load or eject a cartridge from the drive. The handle lifts to the open position and lowers to the closed position.

Rear Panel Controls and Connectors

Figure 4 shows the controls and connectors located on the rear panel of the DS9000 Series.

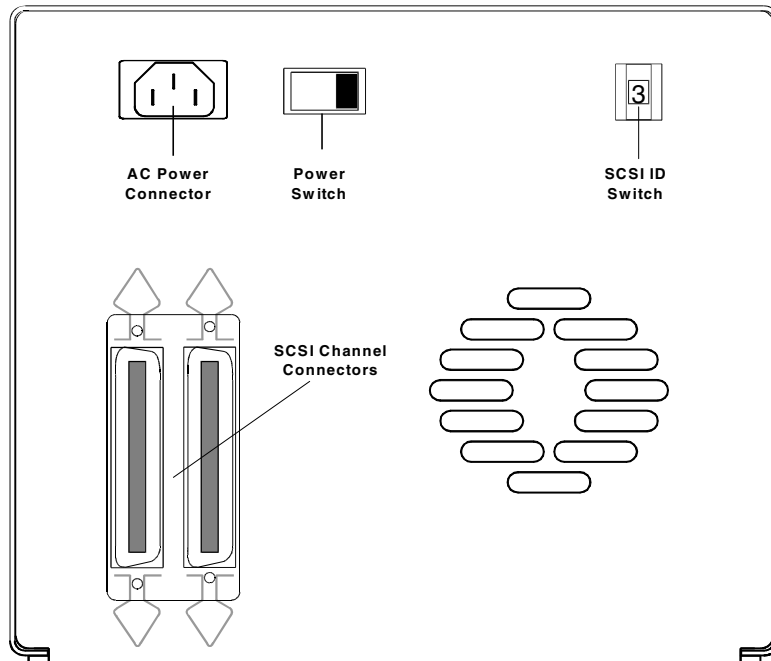

Figure 4. DS9000 Series Rear Panel

Rear Panel Controls and Connectors	
Control or Connector	Purpose
Power Switch	Turns power to the unit on and off.
AC Power Connector	Receptacle for AC power cord.
SCSI Channel Connectors	Connections for the interface cable that connects the unit with the host computer and/or to other devices on the SCSI channel. The interface cable can be attached to either connector. All DS9000 Series models, except the DS9700D and DS9800D, are equipped with a 50-contact, shielded, low density SCSI device connector. The DS9700D and DS9800D, both fast, wide SCSI devices, use a 68-pin high density SCSI device connector.
SCSI ID Switch	Used to select the SCSI ID for the DLT drive. Factory set at 0.

Data Cartridge

The data cartridges used in the DS9000 Series are housed in 4-inch plastic cases and employ ½-inch metal particle tape. Table 4 describes and lists the media cartridges that can be used with the four models.

Media Cartridge				
Model	Drive Model	Cartridge Model	Cartridge Color	Tape Length
DS9400D/L ADIC 4000	DLT4000	DLTTape III	gray	1100 feet
		DLTTape IIIXT	white	1800 feet
		DLTTape IV	brown	1800 feet
DS9700D	DLT7000	DLTTape III	gray	1100 feet
		DLTTape IIIXT	white	1800 feet
		DLTTape IV	brown	1800 feet
DS9800D	DLT8000	DLTTape III	gray	1100 feet
		DLTTape IIIXT	white	1800 feet
		DLTTape IV	brown	1800 feet

Table 4. Media Cartridges

The **Write-Protect** switch prevents accidental erasure of data. If the switch is moved all the way to the left, the cartridge is write-protected and the drive cannot write to, or erase data from, the cartridge. The small orange rectangle will be visible whenever the cartridge is write-protected. Additionally, an arrow (beneath the orange rectangle and above the two lines on the switch), indicates when data cannot be written to the cartridge. If the switch is moved all the way to the right, the cartridge is write-enabled and the drive can write data to, or erase data from, the cartridge. The orange rectangle will not be visible whenever the cartridge is write-enabled. On the right side of the write-protect switch an arrow over one line indicates that data can be written to the cartridge if it is slid to the right.

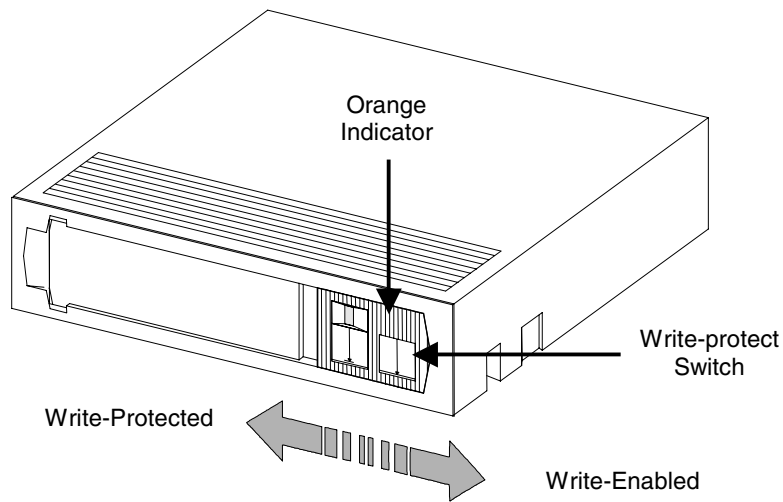

Figure 5. DLT Data Cartridge

Cautions

- Always remove **any** cartridge from the drive before turning off host system power. Failure to remove a cartridge can result in cartridge and drive damage.
- When a cartridge is removed from the drive, return it to the plastic case to prolong the cartridge life.

Other Requirements

SCSI Host Adapter

Your DS9000 Series must be connected to either an integrated SCSI host or a separate SCSI interface (host adapter) card installed in the computer – either directly to the I/O connector on the card or as part of an existing SCSI chain. The host adapter you choose will depend on your system requirements and your needs. If you are not sure about your host adapter requirements, please call ADIC's Technical Assistance Center (ATAC) and ask for assistance. The SCSI interface must be installed before you connect the DS9000 Series.

Application Software

A variety of backup and data storage software is available for use with your DS9000 Series. The software you use will depend upon your storage needs and the system you are using. Please check with ADIC Sales or Customer Assistance if you have a question on the compatibility of a particular software package.

Now you are ready to connect the DS9000 Series to your host computer. Follow the instructions provided in the next chapter.

Blank Page

Chapter 2

Installation

This Chapter. . .

- ☐ explains the steps necessary to install and test the DS9000 Series Devices.
- ☐ provides a ✓ symbol next to each step verified as correct.

Unpacking and Inspecting

Caution

If the operating environment differs from the storage environment by 15° C (30° F) or more, let the unit acclimate to the surrounding environment for at least 12 hours.

Unpack all items from the carton. Save the packing materials in case you need to move or ship the system in the future.

Caution

You must ship the DS9000 Series in the original or equivalent packing materials or your warranty may be invalidated.

Checking the Accessories

Check to make certain that the following items are included with your DS9000 Series:

- Power cord
- One DLT Tape IV data cartridge
- One cleaning cartridge, or a coupon for a free DLT cleaning cartridge
- One SCSI cable
- One SCSI bus terminator
- This manual
- A Warranty Registration card
- ✓ None of the items should show signs of damage.

Installing the Host Adapter

At this point if your host computer system does not have native SCSI capability and the host adapter you are using is not installed, please install it. Refer to the manual that came with your host adapter for specific directions.

When the host adapter card is installed return to this point in the manual.

Connecting the Interface Cable

Attach an interface cable between the host adapter and the DS9000 Series. The kind of cable needed depends on the kind of SCSI bus connector on the host adapter. The DS9000 Series has two SCSI device connectors on the rear panel. It does not matter which connector is used.

Note

The bail locks or jackscrews at the ends of the SCSI cable must be securely fastened to insure communications between the DS9000 Series and the host computer.

- ✓ Make sure that the SCSI cable between the host adapter and the DS9000 Series is secure and the connections are fastened correctly.

Connecting More than One DS9000 Series Unit

If connecting to more than one DS9000 Series unit on the same SCSI channel, connect each unit to the previous unit with an interface cable. The connection sequence between the units is not critical. Refer to Figure 6 to see a configuration set-up.

Note

Don't forget to install the SCSI terminator on the last device in the chain.

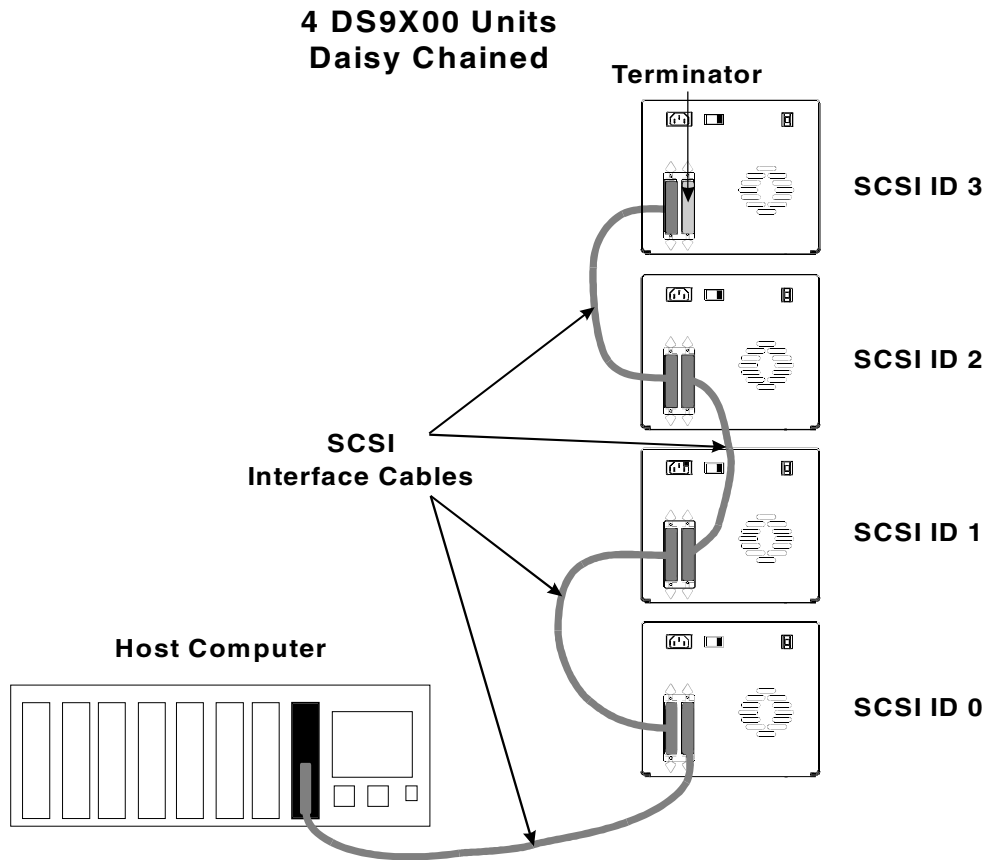

Figure 6. Cable Diagram for 4 DS9000 Series Units

Setting the SCSI ID

The SCSI address of the DS9000 Series may need to be changed, depending upon factors in the setup, operating system, and number of SCSI devices on the bus. Each device on the bus must have its own address. See Figures 6 and 7.

Notes

- The SCSI ID has been factory preset to 0.
- All devices on a SCSI bus must be set to a unique address.

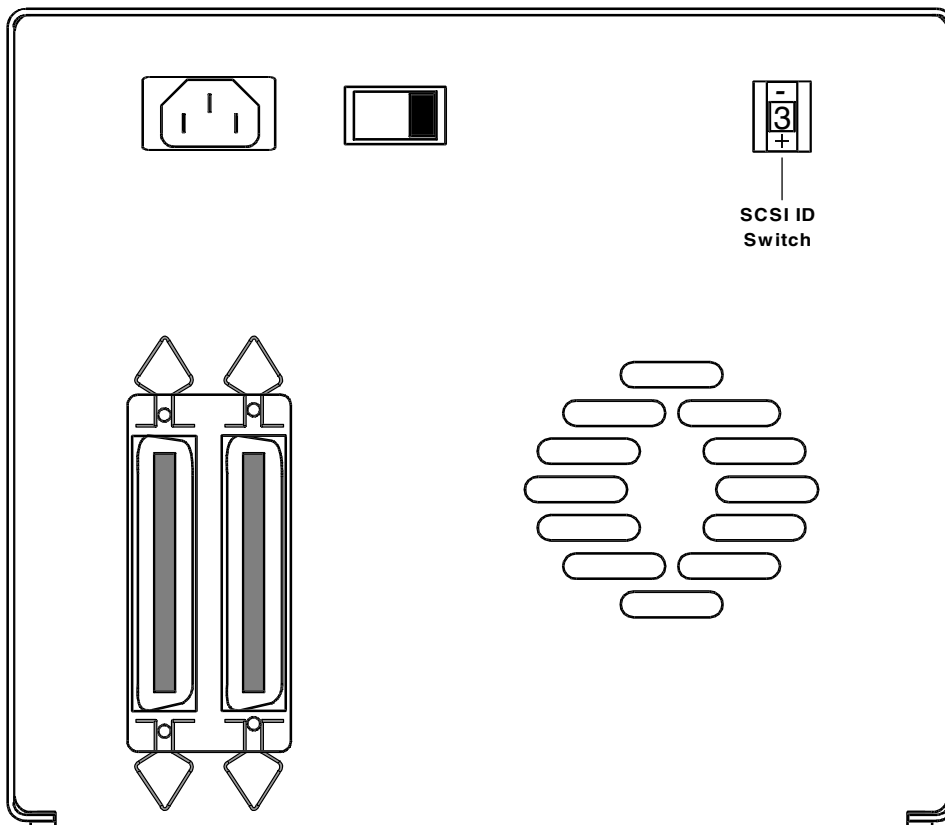

Figure 7. SCSI ID Switch

Note

The ADIC 4000 and DS9400D/L can be set to any SCSI ID between 0 and 7.
The DS9700D and DS9800D, both fast, wide SCSI devices, can be set to any SCSI ID between 0 and 15.

The SCSI ID switch is located on the rear of the DS9000 Series (see Figure 7). Use a small pointed object to press either the + button on the bottom, or the minus button on the top of the switch to select the proper ID.

- ✓ Count each device's SCSI IDs in order from 0 to 7 (or from 0 to 15) on each SCSI bus to confirm that no two devices have the same ID number assigned.

Note

The SCSI Host Adapter is normally set to SCSI ID 7, so this ID is usually not available for a device.

Check the SCSI Bus Termination

SCSI buses require termination at each end for proper operation. A typical external subsystem installation would be terminated at the SCSI host adapter and at the last device in the chain.

If an external device is being used with an internal device (on the same channel), the SCSI host adapter would now be in the middle of the bus rather than at the end. In this case, the termination would be at the internal device and the last drive in the external chain. The terminators on the SCSI host adapter would be removed. Refer to the SCSI host adapter manual for directions on removing the terminators on the board.

- ✓ Is there a terminator installed on each end of the SCSI bus?

Note

ADIC recommends that you always terminate a single-ended bus with an active terminator.

Connecting Power and Turning On

- Plug the power cord into the back of the DS9000 Series.
- Plug the power cord from the DS9000 Series into a GROUNDED electrical outlet.
- Plug the power cord from the host system into the same GROUNDED electrical circuit if possible. Computers and peripherals should always share the same grounds.
- Turn **ON** the power to the host system.
- Turn the DS9000 Series power **ON**.

Note

Turning on the host computer first ensures that the SCSI bus terminators stabilize the bus signals before the tape drive is turned on.

Installing the Application Software

- Refer to the application software installation guide and install the backup software, if necessary.
- ✓ After completing installation of the DS9000 Series unit and backup software, run a small backup/restore test and compare the results to confirm that the unit is working correctly. Refer to the software installation guide for additional information.

Chapter 3

Operation and Maintenance

This Chapter . . .

- describes normal operating features of the DS9000 Series.
- explains how, and when to clean the tape head.
- describes how to clean the enclosure.

Power-on Self-Test

When the system power is **ON**, the DLT drive performs a Power-on Self-Test (POST). The sequence of events is as follows:

1. The LEDs on the right front panel of the DLT drive will turn on sequentially from top to bottom. All LEDs will remain **ON** for a few seconds.
 2. The LEDs on the left front panel will turn **ON** at the same time for about three seconds and then turn **OFF**.
 3. The **Operate Handle**, **Write Protected**, and **Use Cleaning Tape** LEDs will turn **OFF**. The **Tape in Use** LED will blink while the tape drive initializes.
- ✓ If the external SCSI bus terminator has a Term Power LED it should also be illuminated.

Drive Status

LED Indicators

After initialization, the drive will be in one of the four states listed in the following table:

Drive State	LED Indicator Displays and Drive Actions
1. No cartridge is present.	A. The Tape in Use LED turns OFF . B. The Operate Handle LED turns ON . C. The handle is unlatched. D. The drive beeps momentarily.
2. A cartridge is present and the handle is down.	The drive loads the cartridge. When the Tape in Use LED stops blinking and stays ON , the tape's actual density lights. For example, if the actual tape density is 2.6, then the LED turns ON next to the 2.6 label. When the Density Override LED blinks, select a density setting. The drive is ready for use.
3. A cartridge is present, but the handle is up (<i>not recommended</i>).	The Tape in Use LED turns OFF . The Operate Handle LED flashes. When the handle is lowered, the cartridge loads.
4. The drive detects an error condition.	All right or left side LEDs blink repeatedly. Try to unload the tape (if present) and reinitialize the drive by pressing the Unload button or switch the power OFF and then ON . The right or left side LEDs stop blinking and the drive tries to reinitialize. The LEDs turn ON with a constant illumination, and then turn OFF if the test succeeds.

LCD Messages (DS9400D/L, DS9700D and DS9800D)

The following table describes the messages displayed on the LCD during and immediately after the POST:

Drive State	LCD Message
1. POST is executing.	<p style="text-align: center;">Power On Self Test In Progress</p> <p>Will be displayed for 3 to 5 seconds, followed by:</p> <pre style="text-align: center;"> DRV F/W XXXX LCD F/W 0X.XX ID: X </pre> <p>“DRV F/W” is the firmware version of the drive. “LCD F/W” is the firmware version of the LCD controller. “ID” is the SCSI ID setting of the drive.</p> <pre style="text-align: center;"> CPH= XXXX TSL= XXXX DCL= XXXX </pre> <p>“CPH” is the cumulative power on hours of the drive. “TSL” is the time since last cleaning cycle of the drive (will reset to zero after every cleaning cycle if followed by a power recycle). “DCL” is the drive data cartridge load counter.</p>
2. POST completed, no cartridge is present, and the handle is down.	<p style="text-align: center;">ADIC DS9000D Series</p>
3. POST completed, a cartridge is present, but the handle is up (<i>not recommended</i>).	<p style="text-align: center;">Operate Door Handle ↓ ↓ ↓ ↓</p> <p>This message will appear after approximately 5 minutes.</p>
4. The drive detects an error condition.	<p style="text-align: center;">ERROR! HARDWARE FAULT</p>

POST completes in about 13 seconds and the drive responds normally to all commands. However, it may take longer for the media to become ready.

LED Indicators

Use the following table to determine the drive's operating condition:

Right Indicator Panel LED			
Label	Color	State	Operating Condition
Write Protected	Orange	ON OFF	Tape is write-protected. Tape is write-enabled.
Tape in Use	Yellow	Blinking ON	Tape is moving. Tape is loaded; ready for use.
Use Cleaning Tape	Yellow	ON Remains on after unloading cleaning tape After cleaning, turns on again when reloading data cartridge	Drive head needs cleaning, or the tape is bad. Cleaning attempted, but tape expired, so cleaning not performed. Problem data cartridge. Try another cartridge.
Operate Handle	Green	ON OFF Blinking	OK to operate the Cartridge Insert/Release Handle. Do not operate the Cartridge Insert/Release Handle. Drive was powered on with door open. Close door and let drive complete initialization.
All Right Indicator Panel LEDs or, All Left Indicator Panel LEDs	–	ON Blinking	POST is starting. An error has occurred.

(Continued on next page)

Left Indicator Panel LED			
Label	Color	State	Operating Condition
2.6 (ADIC 4000, DS9400D/L, DS9700D)	Yellow	ON Blinking	Tape is recorded in 2.6 format. Tape is recorded in another density. The density selection was chosen earlier from BOT.
6.0 (ADIC 4000, DS9400D/L, DS9700D)	Yellow	ON Blinking	Tape is recorded in 6.0 format. Tape is recorded in another density. The density selection was chosen earlier from BOT.
10.0 (ADIC 4000, DS9400D/L)	Yellow	ON (default) Blinking	Tape is recorded in 10.0 format. Tape is recorded in another density. The density selection was chosen earlier from BOT.
10.0/15.0 (DS9700D, DS9800D)	Yellow	ON (default) Blinking	Tape is recorded in 10.0 or 15.0 format. Tape is recorded in another density. The density selection was chosen earlier from BOT.
20.0 (ADIC 4000, DS9400D/L, DS9700D, DS9800D)	Yellow	ON (default) Blinking	Tape is recorded in 20.0 format. Tape is recorded in another density. The density selection was chosen earlier from BOT.
35.0 (DS9700D, DS9800D)	Yellow	ON (default) Blinking	Tape is recorded in 35.0 format. Tape is recorded in another density. The density selection was chosen earlier from BOT.
40.0 (DS9800D)	Yellow	ON (default) Blinking	Tape is recorded in 40.0 format. Tape is recorded in another density. The density selection was chosen earlier from BOT.
Compress	Yellow	ON OFF	Compression mode enabled. (Compression can be done only in 10.0, 15.0, 20.0, 35.0, and 40.0 density.) Compression mode disabled.
Density Override	Yellow	ON OFF (default) Blinking	A density setting was selected earlier from the front panel. Density will be selected by the host (automatic). The unit is in density selection mode.
All Right Indicator Panel LEDs, or, all Left Indicator Panel LEDs	–	Blinking	A POST error has occurred.

LCD Messages (DS9400D/L, DS9700D and DS9800D only)

The following table describes the messages displayed by the LCD during normal operation:

Drive Operating Condition	LCD Message
No tape in drive.	<pre> ADIC DS9000D Series </pre>
When loading or unloading a tape.	<pre> DLTtype Loading >>> </pre> <p>“type” = 4000 OMX (DS9400D/L), 7000 OMX (DS9700D) or 8000 OMX (DS9800D).</p> <p>During the loading process the display may toggle between “Loading >>>” and “Calibrating >>>”.</p> <pre> DLTtype Calibrating >>> </pre> <div style="border: 1px solid black; padding: 5px; margin: 10px 0;"> <p style="text-align: center;">Note</p> <p>While loading the tape, the drive will enter a false Ready Mode condition for a short period. During this false state the Tape In Use LED will continue to blink. Do not attempt any operations while the LED is blinking.</p> </div> <pre> DLTtype Unloading >>> </pre>
When tape is unloaded.	<pre> Operate Door Handle ↓ ↓ ↓ ↓ </pre>

Continued on next page.

Drive Operating Condition	LCD Message
When tape is loaded.	<pre>DLTtype Compressed Ready Mode 15/30GB</pre> <p>“type” = 4000 OMX (DS9400D/L), 7000 OMX (DS9700D) or 8000 OMX (DS9800D).</p> <p>“Compressed” if compression mode enabled or “Standard” if compression mode disabled.</p> <p>“15/30 GB” is drive dependent. “15/30 GB” = DLT2000XT, “20/40 GB” = DLT4000, “35/70 GB” = DLT7000, and “40/80 GB” = DLT8000.</p> <p>This is the normal “Ready Screen”.</p>
If write-protected tape is inserted.	<p>During loading of a write-protected tape, the display will change from:</p> <p>“Loading >>>” to “Write Protected Tape Inside Drive”, the LCD back-light will toggle on/off and an audible alarm will sound.</p> <pre>Write Protected Tape Inside Drive</pre>
Write-protected tape fully loaded.	<pre>DLTtype Compressed Ready Mode WPT</pre> <p>“WPT” = Write Protected Tape in unit.</p> <p>“WPT” will toggle to “GB” and back to “WPT” and continue toggling until next drive action.</p> <pre>DLTtype Compressed Ready Mode 15/30GB</pre>

Continued on next page.

Drive Operating Condition	LCD Message
<p>Whenever the system is writing to a tape, these two messages will alternate. Each message will be displayed for approximately 2.5 seconds.</p>	<pre>DLTtype 2.1:1 16GB Writing >>> DLTtype Compressed Ready Mode 15/30GB</pre> <p>“Writing” — indicates the system is writing to the tape. “2.1:1” — indicates the current compression ratio being used. “16 GB” — indicates the amount of tape still available to be written to. 3 arrows in motion (>>>) — indicate tape travel.</p>
<p>Whenever the system is reading a tape, this message will alternate with the ready screen.</p>	<pre>DLTtype Compressed Reading >>></pre> <p>Reading — indicates the system is reading from the tape.</p>
<p>Whenever a tape is in motion.</p>	<pre>DLTtype Compressed Motion Message >>></pre> <p>Motion Messages = Loading, Unloading, Reading, Writing, Positioning, Erasing, Cleaning and Rewinding. 3 arrows in motion (>>>) — indicate tape travel.</p>
<p>Whenever an incorrect cartridge type is placed into a drive (i.e. DLTape IV cartridge is placed in DLT2000 or DLT2000XT drive).</p>	<pre>Format Not Valid For This Drive - Unload</pre> <p>The LCD will flash and the beeper will sound while this message is displayed. Press the Unload button, the drive will begin unloading the tape and the LCD will return to normal operation messages.</p>

Continued on next page.

Drive Operating Condition	LCD Message
If new tape, or the drive cannot initialize the tape.	<p>Initialization Time Out:</p> <p>followed by:</p> <p>If Using New Tape Drive Ready</p> <p>followed by:</p> <p>If Tape Has Data Unload & Reload</p>
A hardware error occurs during normal operation.	<p>ERROR!</p> <p>HARDWARE FAULT</p>

Loading the Data Cartridge

Warnings

- Before loading into a drive, ensure that all other items from this package are separated from the cartridge.
- Never press in on the hub portion of the data cartridge.
- Static electricity may cause the label or other items included in the package to occasionally cling to the DLT cartridge.

- In order to write data to, or erase data from the cartridge, check that the **Write-Protect** switch on the cartridge is in the write-enabled position - all the way to the right.

Caution

A data cartridge can be loaded only when the **Operate Handle** LED is **ON**. Do not attempt to open the **Cartridge Insert/Release Handle** unless this LED is **ON** steady.

- Lift up on the **Cartridge Insert/Release Handle**.

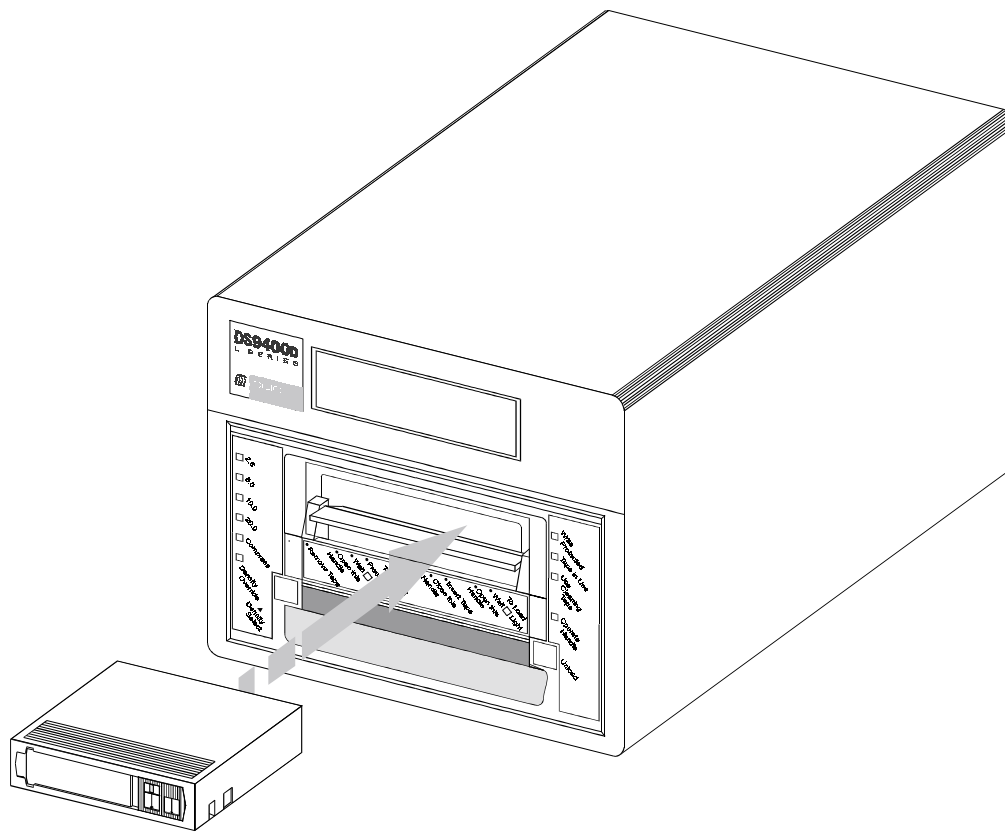

Figure 8. Loading a Data Cartridge

- Insert the data cartridge into the slot.
- Push the cartridge into the drive.
- Push the **Cartridge Insert/Release Handle** closed. The drive will go on-line.
- A load sequence will initiate where the **Operate Handle** LED will turn **OFF** and the **Tape in Use** LED will blink while the drive moves the tape to BOT (Beginning of Tape). When the tape is at BOT, the **Tape in Use** LED will turn **ON** steady. Additionally, one of the compression density LEDs on the Left Indicator Panel may be illuminated or blinking. The tape is now ready for use.

Data Protection

Write-Protection of the Data Cartridge While Inside the Drive

The **Write-Protect** switch on the data cartridge can be moved while the cartridge is loaded into the drive. The drive will turn on the **Write Protected** LED immediately. However, if the drive is writing to the tape, write protect does not take effect until the write operation is completed.

- If you move the **Write-Protect** switch from the write-protected position (on the left) to the write-enabled position (to the right), the tape becomes write-enabled after several seconds.
- If you move the **Write-Protect** switch from the write-enabled position (on the right) to the write-protected position (to the left), the tape becomes write-protected after several seconds.

Write-Protection of the Data Cartridge Outside of the Drive

Move the **Write-Protect** switch to the **left** to write-protect the tape. The **Write Protect LED** (orange) is **ON** and data cannot be written to, or erased from the tape.

Move the **Write-Protect** switch to the **right** to make the tape write-enabled. Data can now be written to, or erased from the tape, assuming it is not already software write-protected.

Tape in Use

Whenever the **Tape in Use** LED (yellow) is **ON** steady, the tape is ready to use. When the tape is being read, written, or rewound, the **Tape in Use** LED blinks.

Use the following table to determine what is happening during cartridge use:

(Right Indicator Panel)		
LED	State	Meaning
Tape in Use	ON steady	A cartridge is loaded, but the tape is not moving. This can mean no application is communicating with the controller, or that the application is communicating but is not delivering commands for tape motion.
	Blinks irregularly	A read or write is in progress.
	Blinks regularly	Tape is loading, unloading, or rewinding.
Operate Handle	ON and beeper sounds	Tape is unloaded into the cartridge and the cartridge can now be removed, or if the drive is unloaded, a cartridge can now be inserted.
All LEDs	Blinking	An error has occurred during operation.

Removing the Data Cartridge

Caution

Remove a cartridge from the drive before turning **OFF** host system power. Failure to remove a cartridge before turning **OFF** host system power can result in cartridge and drive damage.

To unload a cartridge from the drive perform the following steps:

- Push the **Unload** button.
- ✓ The **Tape in Use** LED will blink as the tape rewinds.

Caution

A data cartridge can only be unloaded when the **Operate Handle** LED is **ON**. Do not attempt to open the **Cartridge Insert/Release Handle** unless this LED is **ON** steady.

- When the **Operate Handle** LED is **ON** (and the beeper has sounded), pull the **Cartridge Insert/Release Handle** open to eject the cartridge from the drive.
- Remove the cartridge.
- Push the **Cartridge Insert/Release Handle** closed.

Caution

After the cartridge is removed from the drive, return it to its plastic case to prolong the cartridge life.

Cleaning the Tape Head

The DS9000 Series is a highly sophisticated unit. No routine maintenance is required apart from periodically cleaning the drive head whenever the **Use Cleaning Tape** LED is illuminated and the LCD displays the following message:

```
ATTENTION!  
High Data Error Rate
```

followed by:

```
Clean Heads or  
Use New Tape
```

If the DS9000 Series device fails to operate correctly, immediately call the ADIC Customer Assistance Center (refer to *When You Need Assistance* in Chapter 4, Troubleshooting and Diagnostics, later in this manual).

To clean the head, use a cleaning cartridge. Insert the cleaning cartridge in the drive following the *Loading the Data Cartridge* loading the procedure in Chapter 3. The drive will automatically clean the head. When the cleaning operation is complete, the beeper will sound, indicating that the cleaning cartridge should be removed.

Drive Operating Condition	LCD Message
No tape in drive.	ADIC DS9000D Series
When loading the cleaning tape.	DLTtype Loading >>>
While the cleaning cycle is executing.	DLTtype Cleaning >>>
When the cleaning cycle is completed.	When the cleaning process is complete, the LCD will display the following text for 3 to 5 seconds: CCL= CCA= “CCL” is the Cleaning Cartridge Load Counter is the cumulative number of times a cleaning cartridge has been loaded in this drive. “CCA” is the cumulative number of times this cleaning cartridge has been used to clean a drive.
When tape is unloaded.	Operate Door Handle ↓ ↓ ↓ ↓

Caution

Using cloth swabs, cotton swabs, cleaning agents, or *unapproved* cleaning cartridges will void the warranty. Use *only* an ADIC-approved cleaning cartridge.

Caution

Do not remove the cleaning cartridge before the drive sounds the beeper.

Follow the *Removing the Data Cartridge* procedure in Chapter 3 to remove the cleaning cartridge from the drive.

Note

Loading the cleaning cartridge into the drive at the end of its cleaning cycle will result in a failed or shortened cleaning operation. If the **Use Cleaning Tape** LED is illuminated, replace the cleaning cartridge.

Cleaning the Enclosure

The outside of the enclosure can be cleaned with a damp towel. If a liquid all-purpose cleaner is used, apply it to a towel. **Do not spray the enclosure.**

Chapter 4

Troubleshooting and Diagnostics

This Chapter. . .

- Lists a number of common problems and the actions to take to correct them.
- provides information on why the DLT drive turns on the Use Cleaning Tape LED.
- explains what to do when technical support is needed.

Troubleshooting Chart

If the DS9000 Series fails during POST or operation, use the following table to determine the problem and the action to take:

If . . .	Then . . .	Response . . .
The system does not recognize the DS9000 Series unit	The system may not be configured to recognize the SCSI ID	Configure the system to see the ID.
	The SCSI ID might not be unique	Change the SCSI ID and reconfigure the system. The new ID is effective at the next power-on.
	The parameters for the SCSI adapter may be incorrect	Check the SCSI adapter installation.
	The SCSI signal cable may be loose	Make sure the connector on each end of the cable is fully seated and the bail locks are secure.
	The SCSI terminator may not be present or might be loose	Install the terminator; make sure the terminator is fully seated and the bail locks are secure.
	The SCSI bus may not be correctly terminated	If the DS9000 Series unit is the last or only device on the bus, make sure the terminator is installed on the DS9000. If the DS9000 Series unit is not the last or only device on the bus, check the cable connections and make sure the terminator is installed at the end of the bus.

(continued on next page)

If . . .	Then . . .	Response . . .
The system does not recognize the DS9000 Series unit	<p>The SCSI terminator may not be at the end of the bus, or more than two terminators may be present</p> <ol style="list-style-type: none"> 1. The SCSI bus might be too long. 2. Too many devices might be on the bus 	<p>Be sure to install a terminator at each end of the bus. One terminator is usually installed at the host system.</p> <ol style="list-style-type: none"> 1. Limit the SCSI bus length to 3 meters (9.8 feet) for SE configurations, 12 meters (39.4 feet) for LVD/SE configurations, and 25 meters (82 feet) for HVD configurations. 2. Limit the number of devices on the bus. <p>Check the system configuration rules.</p>
The DS9000 Series unit does not power up	The DS9000 Series unit has no power	Check the DS9000 Series unit power cord connections with the DS9000 Series unit power switch OFF.
All right or all left indicator panel LEDs on the drive front panel blink	A drive fault has occurred	<p>Try to unload the tape and reinitialize the drive by pressing the Unload button or turn the DS9000 Series unit power off and then on again.</p> <p>The LEDs will stop blinking and the drive will try to reinitialize. The LEDs will turn on steady again and go off if the test succeeds.</p>
Undetermined fatal or nonfatal errors have been detected.	<p>The bus termination or SCSI signal cable connections might be incorrect</p> <p>The AC power source grounding might be incorrect</p>	<p>Make sure the SCSI bus is terminated.</p> <p>Use an AC outlet for the DS9000 Series unit on the same AC circuit as the AC line powering the host system.</p>

Use Cleaning Tape LED

If an excessive number of read-after-write errors are detected during normal operation of the DS9000 Series unit, the **Use Cleaning Tape LED** will be turned on by the drive.

Usually, the **Use Cleaning Tape LED** is turned on by the drive because of a dirty head, so the head should be cleaned (see *Cleaning the Tape Head* in Chapter 3, earlier in this manual) and the operation tried again.

If the **Use Cleaning Tape LED** is again turned on and this appears that to be a cartridge rather than a drive problem, perform a complete backup from the source drive with a different cartridge, if necessary. Then discard the old cartridge. If unsure of the problem source, call ADIC Technical Assistance Center. For additional information see the section, *When Assistance is Required*, later in this chapter.

The **Use Cleaning Tape LED** is normally turned off by executing a cleaning cycle or by cycling power to the DS9000 Series.

Why the Use Cleaning Tape LED Gets Turned ON

The **Use Cleaning Tape LED** will be turned on whenever the drives determine that low level error performance has degraded to a point where drive head cleaning is necessary. It does this by counting the number of C3 (soft) errors as well as the RAW (Read After Write) errors over a number of Mbytes. When a predetermined error rate threshold is reached, the drive displays the warning. Some drives display the warning after a specified number of hours of tape motion have been logged. When a tape is loaded, it may take several minutes for the indication to come on because the drive will wait for a specific number of bytes to be written. A hard (non-recoverable) error will cause the warning to be displayed immediately.

The most common reasons the **Use Cleaning Tape LED** illuminates are listed below, in order of highest rate of occurrence:

- Dirty ("Stained") heads.
A cleaning cycle *must* be executed to clear this indication.
- Worn tape.
DLTTape IV cartridges are rated at 1,000,000 passes. Applications that overwrite small blocks of data cause "shoe shining" of the tape against the head and will reach the 1,000,000 passes sooner than might be expected.
- Harmful environment.
Data errors result from a number of factors, each of which subtract from the margin between good data recovery and an error. Electrical or magnetic interference magnetic can decrease this margin. High levels of dust contamination, high humidity, and heat can also be significant factors.

Example

Placing a CRT monitor on top of, or directly next to, a DS9000 Series should always be avoided.

- Worn heads.
The tape heads will eventually wear out causing the time between cleanings to get shorter and shorter.

-
- Defective drive.
Drive amplifier settings could be off, causing error rate degradation. The drive may have failed.

High Humidity

To minimize the chance of condensation, please observe the following guidelines:

- After exposing cartridges to temperatures outside the operating limits (5-40°C/40-113°F), stabilize them before use by keeping the cartridges at room temperature for a minimum of two hours.
- Avoid temperature problems by ensuring that the ventilator slots at the front of the drive and the grille on the bottom of the chassis are not obstructed so that the drive has adequate ventilation.
- Position the drive where the temperature is relatively stable, for example, away from open windows, fan heaters, and doors.
- Avoid leaving cartridges in severe temperature conditions, for example, in a car standing in bright sunlight.
- Avoid transferring data (reading from and writing to cartridges) when the temperature is changing by more than 10°C per hour.

When Assistance is Required

Calling ADIC's Technical Assistance Center (ATAC)

Customer Support is provided free of charge to all ADIC customers who have a maintenance or warranty agreement. Customers should provide the unit's serial number when calling for support.

Warranty exchange service is available to all customers who have validated their warranty by returning the warranty card shipped with their unit, in accordance with the terms of the warranty.

Before calling ATAC, follow these steps:

- Consult the documentation to solve any problems. Most questions are answered in the documentation.
- Identify whether the software or hardware worked properly anytime before the call was made. Also note if anything was changed in the system recently.
- Pinpoint the exact location of the problem, if possible. Note the steps you took which led to the problem. Can the user recreate the problem or is it a one-time occurrence?
- Note any error messages displayed on the PC screen or file server and record the exact error message.
- If possible, call while at the computer with the ADIC system installed and turned on.
- If running on a network, collect all pertinent information (model type, version #, network hardware, etc.) and be prepared to share it.
- Be prepared to provide the following information:
 - Name
 - Company name
 - ADIC model number
 - Serial number of ADIC unit
 - Hardware configuration
 - Software configuration
 - A brief description of the problem
 - Where the ADIC system was purchased.

If this information is readily available when calling customer support, ADIC will be able to resolve the problem more quickly and efficiently.

Note

In the US and Canada, call ATAC at 1-800-827-3822.

In Europe, call ATAC at +800.9999.3822.

Please note that ADIC telephone support services are not provided as a substitute for proper review and use of applicable ADIC user manuals.

Appendix

A

Specifications

This Appendix . . .

- contains specification information on the DS9000 Series.

Drive

Type:	Quantum DLT4000	ADIC 4000, DS9400D/L
	Quantum DLT7000	DS9700D
	Quantum DLT8000	DS9800D
Data Transfer Rate	180 MB/min.	ADIC 4000, DS9400D/L
(compressed mode):	600 MB/min.	DS9700D
	720 MB/min	DS9800D

Enclosure

Electrical Interface:	SCSI	ADIC 4000, DS9400D/L
	SCSI Fast, Wide	DS9700D
	SCSI Fast, Wide	DS9800D
Physical Interface	50-pin, shielded, low-density device connector	
	68-pin, shielded, high-density device connector	

Reliability

Maintenance	Periodic cleaning of drive head using DLT cleaning cartridge.
MTBF:	More than 80,000 power-on hours
MTTR:	Within 30 minutes (drive replacement)

Physical

Dimensions:	5.75"(h) x 10.50" (w) x 14.50" (d)
Weight:	14 lbs.

Environment

Electrical:	100-240 vac, 50-60 Hz, 0.6 - 0.3A
Power Consumption:	less than 40 watts
BTU/Hour:	170 to 205
Temperature:	5 ° C to 10° C (Operating)
	-40° C to 66° C (Storage/Shipping)
Humidity:	20% to 80% (Operating)
	10% to 95% (Storage/Shipping)
Vibration:	0.25G (5-500 Hz) (Operating)
	0.5G (5-500 Hz) (Storage/Shipping)
Shock:	2G Operating
	30G Storage/Shipping

Appendix

B

Drive Configuration

This Appendix . . .

- describes the options that can be selected by installing jumpers on the DLT Tape Drives.

SCSI Bus Parity

DLT4000 Drives

If the host computer system does not generate SCSI bus parity, disable the parity checking function in the DLT drives by installing a jumper over two pins on the SCSI ID connector. See Figure 9 for location of the connector.

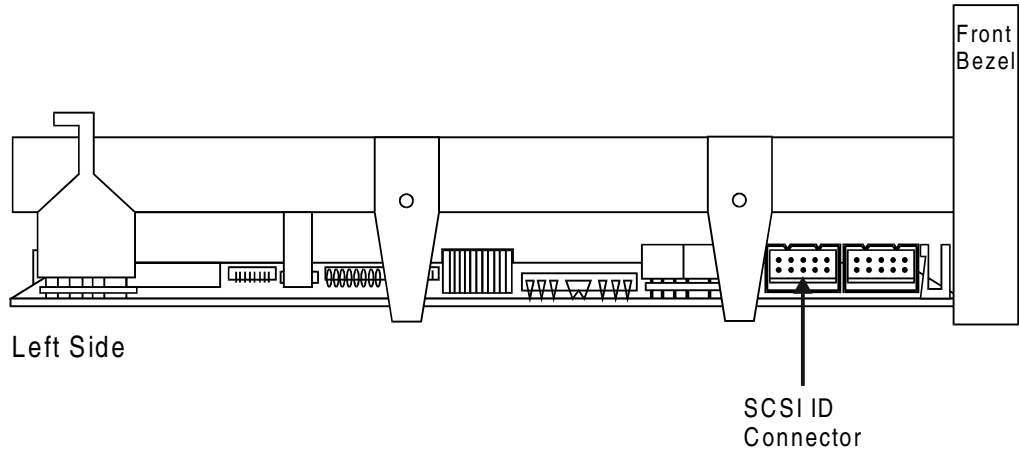

Figure 9. DLT4000 Tape Drive Connectors (left side)

Figure 10 shows which pins of the SCSI ID connector have to be connected by jumpers in order to disable parity.

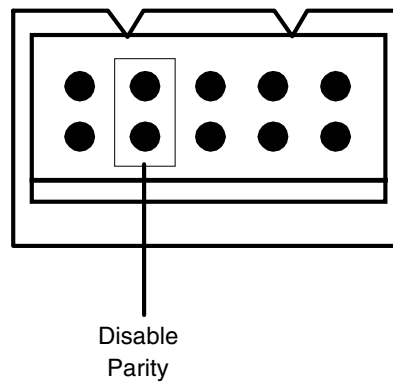

Figure 10. Disable Parity Pins on SCSI ID Connector

DLT7000/DLT8000 Drives

If the host computer system does not generate SCSI bus parity, disable the parity checking procedure in the DLT7000/DLT8000 drive by installing a jumper over two pins on the DFDT connector. See Figure 11 for location of the connector.

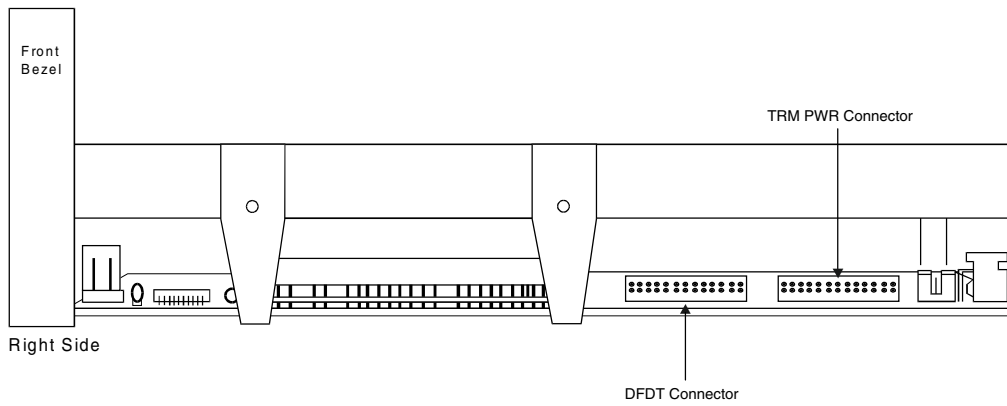

Figure 11. DLT7000/DLT8000 Tape Drive Connectors (right side)

Figure 12 shows which pins of the DFDT connector have to be connected by jumper cables in order to disable parity.

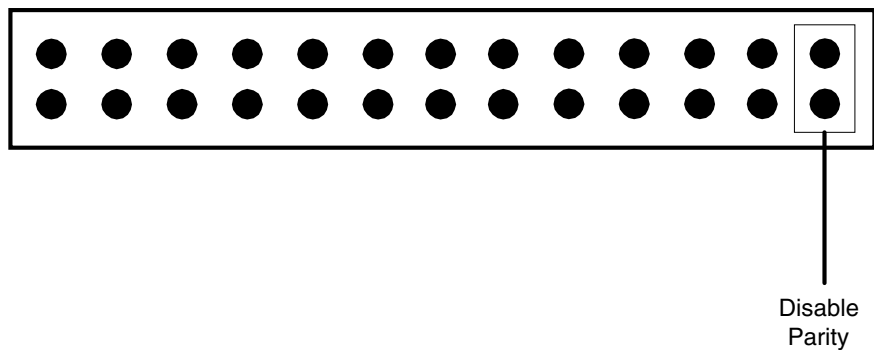

Figure 12. Disable Parity Pins on DFDT Connector

SCSI Bus Termination and Terminator Power

Note

The SCSI bus must be terminated at both ends, and at least one device must supply terminator power.

DLT4000 Drives

The DLT4000 drive can be configured to supply terminator power and termination on the bus, by placing jumpers across specific pins on the TRM PWR/TRM ENB connector (see Figure 13 for the location of the TRM PWR/TRM ENB connector).

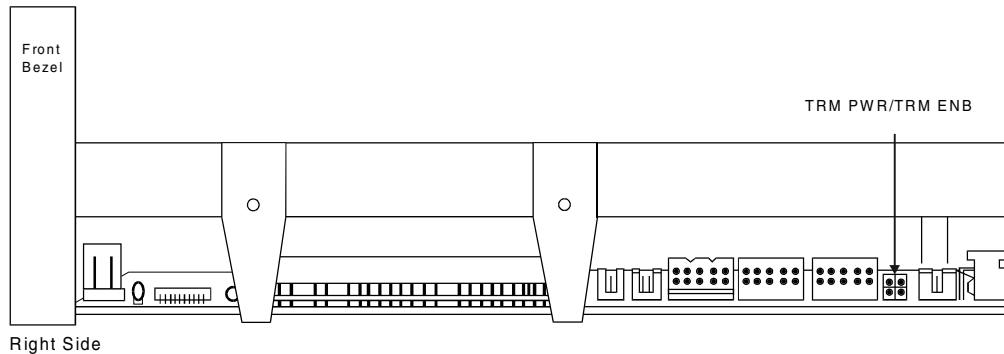

Figure 13. DLT4000 Tape Drive Connectors (right side)

Figure 14 and the table following it illustrate the possible position(s) for the TRM PWR/TRM ENB jumper(s).

Warning

If an external SCSI terminator is used, configurations ② and ④ in Figure 14 cannot be used.

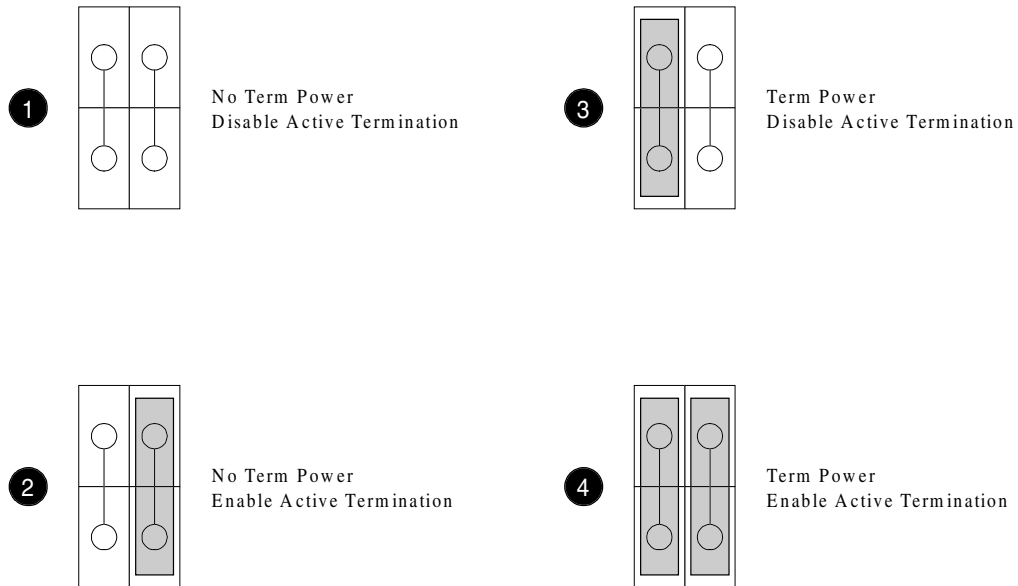

Figure 14. TRM PWR/TRM ENB Jumper Positions

If . . .	And . . .	Response . . .
Another device is providing terminator power	The DS9000 Series <i>is not</i> at the end of the SCSI bus chain	Connect jumpers as ❶ in Figure 12.
Another device is providing terminator power	The DS9000 Series <i>is</i> at the end of the SCSI bus chain	Connect jumpers as ❷ in Figure 12.
No other device on the SCSI bus is providing terminator power	The DS9000 Series <i>is not</i> at the end of the SCSI bus chain	Connect jumpers as ❸ in Figure 12.
No other device on the SCSI bus is providing terminator power	The DS9000 Series <i>is</i> at the end of the SCSI bus chain	Connect jumpers as ❹ in Figure 12.

DLT7000/DLT8000 Drives

The DLT7000/DLT8000 drives can be configured to supply terminator power, by placing jumpers across specific pins on the TRM PWR connector (see Figure 15 for the location of the TRM PWR connector, and Figure 16 for location of pin pair 3/4).

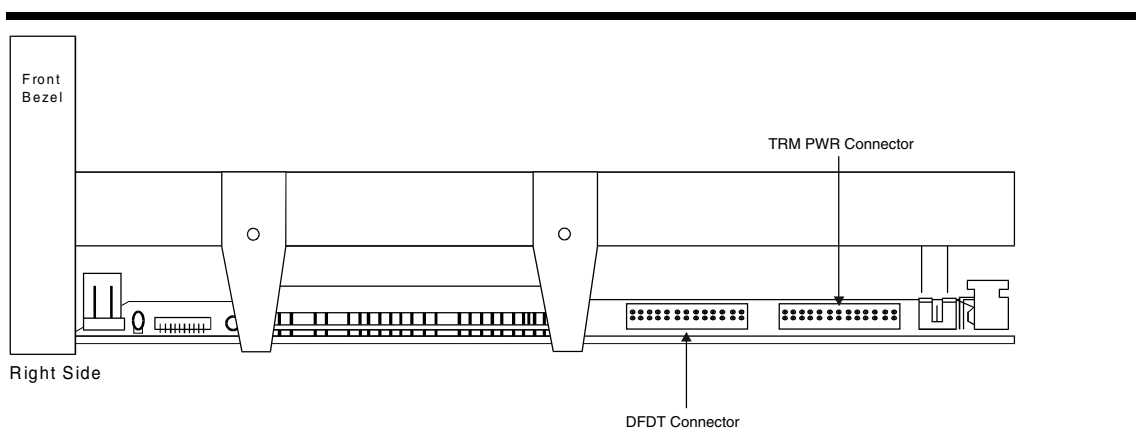

Figure 15. DLT7000/DLT8000 Tape Drive Connectors (right side)

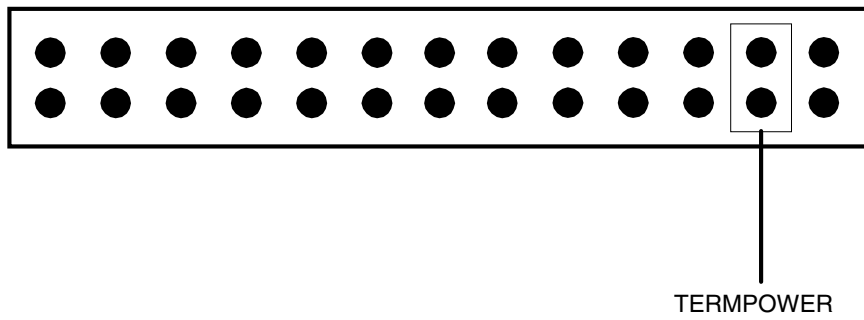

Figure 16. Term Power Pins on TRM PWR Connector

Index

#

10.0 format, 21
10.0 GB format, 6
10.0 GB tape format, 2
15.0 format, 21
15.0 GB format, 6
2.6 format, 21
2.6 GB format, 6
2.6 GB tape format, 2
20.0 format, 21
20.0 GB format, 6
6.0 format, 21
6.0 GB format, 6
6.0 GB tape format, 2
70.0 GB format, 6

A

AC Power Connector, 8
application software, 2
Application Software, 9

B

backup software, 9, 16
bail locks, 12, 32
beeper, 23
Beeper, 6

C

cartridge insert/release handle, 6
Cartridge Insert/Release Handle, 6, 20, 25, 26, 28
cleaning cartridge, 12, 29, 30, 38
cleaning the drive head, 28
cleaning the enclosure, 30
Cleaning the Tape Head, 28
Compress LED, 6
Compression mode, 6
compression mode disabled, 23
Compression mode disabled, 21
compression mode enabled, 23
Compression mode enabled, 21
configuration, 13
Copyright Notice, ii
Copyright Notice (Europe), iii
customer assistance, 34

Customer Assistance, 36
Customer Assistance Center, 29

D

data cartridge, 8, 9, 25, 26, 42
Data cartridge, 25
data storage software, 9
data transfer rate, 38
Density Override LED, 6, 18
Density Select 10.0 LED, 6
Density Select 15.0 LED, 6
Density Select 2.6 LED, 6
Density Select 20.0 LED, 6
Density Select 6.0 LED, 6
Density Select 70.0 LED, 6
density selection mode, 6, 21
dimensions, 38
disable parity, 40, 41
DLT drives, 2
drive error messages, 6
Drive head, 6
drive operating condition, 20
Drive Operating Conditions, 19
drive POST results, 6
drive Power-On Self-Test (POST), 2
Drive Status, 18
drive status messages, 2, 6
drive type, 38

E

electrical, 38
electrical interference, 34
EMI/RFI Compliance, v
environment, 34
environmental attributes, 38
error messages, 2, 36

F

front panel, 3, 6, 18, 21, 29, 33

H

hardware error, 25
heads, 34, 35
host adapter, 12

host adapter, 9, 13
host computer, 8, 9, 12, 16, 40, 41
humidity, 34
Humidity, 35, 38

I

I/O connector, 9
installing backup software, 16
interchange compatibility, 2
interface cable, 8, 12, 13

L

loading the data cartridge, 29

M

magnetic interference, 34
maintenance, 28
Mean Time Between Failures, 38
Mean Time To Repair, 38
media, 19
Motion Messages, 24

O

Operate Handle LED, 6, 18, 20, 25, 26, 27, 28
operating environment, 12

P

physical attributes, 38
POST, 18, 19, 20, 21, 32
power consumption, 38
Power LED, 18
power switch, 8, 33
Power-on Self-Test, 18

R

Ready Mode, 22
rear panel, 7, 12
reliability, 38
Removing the Data Cartridge, 28

S

SCSI adapter, 32
SCSI address, 14
SCSI bus, 15, 16, 32, 33, 42, 43
SCSI bus chain, 43
SCSI bus connector, 12
SCSI bus parity, 40, 41
SCSI Bus Parity, 40
SCSI Bus Termination, 15
SCSI Bus Termination and Terminator Power, 42
SCSI cable, 13
SCSI chain, 9
SCSI channel, 8, 13
SCSI Channel Connectors, 8
SCSI device connectors, 12
SCSI devices, 14
SCSI host adapter, 15
SCSI Host Adapter, 15
SCSI ID, 8, 14, 15, 32
SCSI ID connector, 40, 41
SCSI ID switch, 15
SCSI ID Switch, 8
SCSI interface, 9
SCSI interface cable, 12
SCSI signal cable, 32
SCSI terminator, 32, 33
SCSI terminator, 13, 15, 18
Shock, 38
surrounding environment, 12
system configuration, 33

T

tape density, 2
Tape in Use LED, 6, 18, 20, 26, 27, 28
Tape In Use LED, 22
temperature, 35, 38
temperature problems, 35
term power, 42, 43
terminator, 15

U

Unload button, 18, 28, 33
Unload Button, 6
Use Cleaning Tape LED, 6, 18, 20, 28, 30, 34

V

ventilation, 35
Vibration, 38

W

warranty, *ii, iii, 12, 29, 36*
weight, 38
write enabled, 6
Write Protected LED, 6, 18, 20, 27
write-enabled, 8, 20, 25, 27
Write-Protect switch, 8, 25, 27
write-protected, 6, 8, 20, 23, 27

Free Manuals Download Website

<http://myh66.com>

<http://usermanuals.us>

<http://www.somanuals.com>

<http://www.4manuals.cc>

<http://www.manual-lib.com>

<http://www.404manual.com>

<http://www.luxmanual.com>

<http://aubethermostatmanual.com>

Golf course search by state

<http://golfingnear.com>

Email search by domain

<http://emailbydomain.com>

Auto manuals search

<http://auto.somanuals.com>

TV manuals search

<http://tv.somanuals.com>