

PPC-120/140

Pentium® MMX processor-based
panel PC with 12.1"/13.8" LCD
flat panel display

Copyright Notice

This document is copyrighted, 1998, by Advantech Co. Ltd. All rights are reserved. Advantech Co., Ltd. reserves the right to alter the products described in this manual at any time without notice.

No part of this manual may be reproduced, copied, translated or transmitted in any form or by any means without the prior written permission of Advantech. Information provided in this manual is intended to be accurate and reliable. However, Advantech assumes no responsibility for use of this manual, nor for any infringements upon the rights of third parties which may result from such use.

All brand and product names mentioned herein are trademarks or registered trademarks of their respective holders.

Part No. 2002012010

2nd Edition Printed in Taiwan August 1998

FCC Class B

This equipment has been tested and found to comply with the limits for a Class B digital device, pursuant to Part 15 of the FCC Rules. These limits are designed to provide reasonable protection against harmful interference when the equipment is operated in a residential environment. This equipment generates, uses and can radiate radio frequency energy. If not installed and used in accordance with this user's manual, it may cause harmful interference to radio communications. Note that even when this equipment is installed and used in accordance with this user's manual, there is still no guarantee that interference will not occur. If this equipment is believed to be causing harmful interference to radio or television reception, this can be determined by turning the equipment on and off. If interference is occurring, the user is encouraged to try to correct the interference by one or more of the following measures:

- Reorient or relocate the receiving antenna
- Increase the separation between the equipment and the receiver
- Connect the equipment to a power outlet on a circuit different from that to which the receiver is connected
- Consult the dealer or an experienced radio/TV technician for help

Warning: Any changes or modifications made to the equipment which are not expressly approved by the relevant standards authority could void your authority to operate the equipment.

Packing List

Before installing your panel PC, ensure that the following materials have been received:

- PPC-120/140 series panel PC
- User's manual
- Accessories for PPC-120/140
 - Y-shaped adapter for PS/2 mouse and AT keyboard
 - Power cord (1.8 m) - USA type (other types are available on request)
 - Floppy disk with CD-ROM drive driver
 - "PPC-120/140 Drivers and Utilities" CD-ROM disc
 - Mounting kits and packet of screws
 - "Touchscreen Drivers" CD-ROM disc (refer to Note 1)
 - Heat sink with CPU fan (optional) (refer to Notes 2 and 3)

If any of these items are missing or damaged, contact your distributor or sales representative immediately.

*Note 1: (a) The "Touchscreen Drivers" CD-ROM only comes with panel PCs equipped with the touchscreen function.
(b) To save on resources, Advantech plans to copy the touchscreen drivers onto the "PPC-120/140 Drivers and Utilities" CD-ROM disc shortly.
(c) If your panel PC is equipped with a touchscreen, but you cannot find the "Touchscreen Drivers" CD-ROM disc in your package, then please check the contents of your "PPC-120/140 Drivers and Utilities" CD-ROM disc. The touchscreen drivers should be located there.*

Note 2: If the unit you have bought is basic (i.e. without a CPU, HDD, or SDRAM), you will find this optional item in the accessory box.

Note 3: If you install an Intel Pentium® MMX processor yourself, you must install a heat sink with a CPU fan above the CPU. This procedure will avoid heat damage to the CPU.

Additional Information and Assistance

1. Visit the Advantech Web sites at **www.advantech.com** or **www.advantech.com.tw** where you can find the latest information about the product.
2. Contact your distributor, sales representative, or Advantech's customer service center for technical support if you need additional assistance. Please have the following information ready before you call:
 - Product name and serial number
 - Description of your peripheral attachments
 - Description of your software (operating system, version, application software, etc.)
 - A complete description of the problem
 - The exact wording of any error messages

Safety Instructions

1. Read these safety instructions carefully.
2. Keep this User's Manual for later reference.
3. Disconnect this equipment from any AC outlet before cleaning. Use a damp cloth. Do not use liquid or spray detergents for cleaning.
4. For plug-in equipment, the power outlet socket must be located near the equipment and must be easily accessible.
5. Keep this equipment away from humidity.
6. Put this equipment on a reliable surface during installation. Dropping it or letting it fall may cause damage.
7. The openings on the enclosure are for air convection. Protect the equipment from overheating. **DO NOT COVER THE OPENINGS.**
8. Make sure the voltage of the power source is correct before connecting the equipment to the power outlet.
9. Position the power cord so that people cannot step on it. Do not place anything over the power cord.
10. All cautions and warnings on the equipment should be noted.
11. If the equipment is not used for a long time, disconnect it from the power source to avoid damage by transient overvoltage.
12. Never pour any liquid into an opening. This may cause fire or electrical shock.
13. Never open the equipment. For safety reasons, the equipment should be opened only by qualified service personnel.
14. If one of the following situations arises, get the equipment checked by service personnel:
 - a. The power cord or plug is damaged.
 - b. Liquid has penetrated into the equipment.
 - c. The equipment has been exposed to moisture.
 - d. The equipment does not work well, or you cannot get it to work according to the user's manual.
 - e. The equipment has been dropped and damaged.
 - f. The equipment has obvious signs of breakage.
15. **DO NOT LEAVE THIS EQUIPMENT IN AN UNCONTROLLED ENVIRONMENT WHERE THE STORAGE TEMPERATURE IS BELOW -20° C (-4° F) OR ABOVE 60° C (140° F). THIS MAY DAMAGE THE EQUIPMENT.**

The sound pressure level at the operator's position according to IEC 704-1:1982 is no more than 70dB(A).

DISCLAIMER: This set of instructions is given according to IEC 704-1. Advantech disclaims all responsibility for the accuracy of any statements contained herein.

Wichtige Sicherheitshinweise

1. Bitte lesen sie Sich diese Hinweise sorgfältig durch.
2. Heben Sie diese Anleitung für den späteren Gebrauch auf.
3. Vor jedem Reinigen ist das Gerät vom Stromnetz zu trennen. Verwenden Sie Keine Flüssig-oder Aerosolreiniger. Am besten dient ein angefeuchtetes Tuch zur Reinigung.
4. Die Netzanschlussteckdose soll nahe dem Gerät angebracht und leicht zugänglich sein.
5. Das Gerät ist vor Feuchtigkeit zu schützen.
6. Bei der Aufstellung des Gerätes ist auf sicheren Stand zu achten. Ein Kippen oder Fallen könnte Verletzungen hervorrufen.
7. Die Belüftungsöffnungen dienen zur Luftzirkulation die das Gerät vor überhitzung schützt. Sorgen Sie dafür, daß diese Öffnungen nicht abgedeckt werden.
8. Beachten Sie beim Anschluß an das Stromnetz die Anschlußwerte.
9. Verlegen Sie die Netzanschlusbleitung so, daß niemand darüber fallen kann. Es sollte auch nichts auf der Leitung abgestellt werden.
10. Alle Hinweise und Warnungen die sich am Geräten befinden sind zu beachten.
11. Wird das Gerät über einen längeren Zeitraum nicht benutzt, sollten Sie es vom Stromnetz trennen. Somit wird im Falle einer Überspannung eine Beschädigung vermieden.
12. Durch die Lüftungsöffnungen dürfen niemals Gegenstände oder Flüssigkeiten in das Gerät gelangen. Dies könnte einen Brand bzw. elektrischen Schlag auslösen.
13. Öffnen Sie niemals das Gerät. Das Gerät darf aus Gründen der elektrischen Sicherheit nur von autorisiertem Servicepersonal geöffnet werden.
14. Wenn folgende Situationen auftreten ist das Gerät vom Stromnetz zu trennen und von einer qualifizierten Servicestelle zu überprüfen:
 - a - Netzkabel oder Netzstecker sind beschädigt.
 - b - Flüssigkeit ist in das Gerät eingedrungen.
 - c - Das Gerät war Feuchtigkeit ausgesetzt.
 - d - Wenn das Gerät nicht der Bedienungsanleitung entsprechend funktioniert oder Sie mit Hilfe dieser Anleitung keine Verbesserung erzielen.
 - e - Das Gerät ist gefallen und/oder das Gehäuse ist beschädigt.
 - f - Wenn das Gerät deutliche Anzeichen eines Defektes aufweist.

Der arbeitsplatzbezogene Schalldruckpegel nach DIN 45 635 Teil 1000 beträgt 70dB(A) oder weiger.

DISCLAIMER: This set of instructions is given according to IEC704-1. Advantech disclaims all responsibility for the accuracy of any statements contained herein.

Contents

Chapters

1	General Information	1
1.1	Introduction	2
1.2	How to Use This Manual	4
1.3	Specifications	6
	General	6
	Standard PC functions	6
	PCI SVGA/flat panel interface	7
	Audio function	7
	PCI bus Ethernet interface	7
	Touchscreen (optional)	8
	Optional modules	8
	Environment	9
1.4	Dimensions	10
2	System Setup	11
2.1	A Quick Tour of the Panel PC	12
2.2	Preparing For First-time Use	15
2.3	Installation Procedures	16
	2.3.1 Connecting the power cord	16
	2.3.2 Connecting the keyboard and mouse	17
	2.3.3 Switching on the power	17
2.4	Running the BIOS Setup Program	18
2.5	Installing System Software	19
2.6	Installing the Drivers	19
3	Using the Panel PC	21
3.1	Introduction	22
3.2	Floppy Drive	22
3.3	CD-ROM Drive	23

3.4	PCMCIA	24
3.5	PS/2 Mouse and Keyboard	27
3.6	PCI/ISA Bus Expansion	27
3.7	Parallel Port	29
3.8	Serial COM Ports	29
3.9	VGA Port	30
3.10	Game Port	30
3.11	USB Ports	30
3.12	Audio Interface	31
3.13	Ethernet	31
3.14	Adjusting the LCD Contrast and Brightness	31
3.15	Infrared Module	32
3.16	Touchscreen (Optional)	32
4	Hardware Installation and Upgrading	33
4.1	Overview of Hardware Installation and Upgrading	34
4.2	Disassembling the Panel PC	35
4.3	Installing the 2.5" Hard Disk Drive (HDD)	37
4.4	Installing the Central Processing Unit (CPU)	38
4.5	Installing the SDRAM Memory Module	40
4.6	Installing the Floppy Disk Drive (FDD)	41
4.7	Installing the CD-ROM Drive	42
5	Jumper Settings and Connectors	43
5.1	Jumpers and Connectors	44
5.1.1	Setting jumpers	44
5.1.2	Jumpers	45
5.1.3	Locating jumpers	46
5.1.4	Connectors	47
5.1.5	Locating connectors	48

5.2	CPU Installation and Upgrading	49
5.2.1	System clock setting (JP11, JP8)	49
5.2.2	CPU core voltage setting (JP13)	51
5.2.3	CPU frequency ratio setting (JP14)	54
5.2.4	CMOS clear for external RTC (JP12)	56
5.2.5	Cyrix linear mode enable (JP10)	56
5.2.6	Reset system (JP16)	57
5.3	COM-port Interface	58
5.3.1	COM2 RS-232/422/485 setting (JP3, JP4, JP5)	58
5.3.2	COM3/COM4/RI pin setting (JP2, JP1) (Reserved)	59
5.4	VGA Interface	60
5.4.1	LCD panel V _{cc} power setting (JP6)	60
5.4.2	Panel type select (JP9)	61
5.5	Watchdog Timer Configuration	63
5.5.1	Watchdog activity selection (JP15)	63
6	PCI Bus Ethernet Interface	65
6.1	Introduction	66
6.2	Installation of Ethernet Driver	66
6.2.1	Installation for MS-DOS & WINDOWS 3.1	67
6.2.2	Installation for WINDOWS 95	68
6.2.3	Installation for WINDOWS NT	70
6.3	Further Information	72
7	PCI SVGA Setup	73
7.1	Introduction	74
	Chipset	74
	Display memory	74
	Display types	74
7.2	Installation of SVGA driver	75
7.2.1	Installation for Windows 3.1	76
7.2.2	Installation for Windows 95	78
7.2.3	Installation for Windows NT	81
7.2.4	Installation for OS/2	84
7.3	Further Information	86

8	Audio	87
8.1	Introduction	88
8.2	Installation of Audio Driver	88
	8.2.1 Installation of MS-DOS	88
	8.2.2 Changing settings in DOS	89
	8.2.3 Controlling volume in DOS	90
	8.2.4 Installation for WINDOWS 3.1	91
	8.2.5 Installation for WINDOWS 95	92
	8.2.6 Installation for WINDOWS NT	95
9	Award BIOS Setup	97
9.1	Award BIOS Setup	98
9.2	CMOS Setup Utility	98
9.3	Standard CMOS Setup	99
	9.3.1 Hard Disk Configurations	100
9.4	BIOS Features Setup	101
9.5	Chipset Features Setup	104
9.6	Power Management Setup	105
9.7	PNP/PCI Configuration Setup	109
9.8	Load BIOS Defaults	111
9.9	Load Setup Defaults	111
9.10	Integrated Peripherals	112
9.11	Password Setting	115
9.12	IDE HDD Auto Detection	116
9.13	Save and Exit Setup	118
9.14	Exit Without Saving	118

10	Touchscreen	119
10.1	Introduction	120
10.1.1	General information	120
10.1.2	Specifications	120
10.1.3	Environmental specifications	120
10.2	Installation of Touchscreen Driver	121
10.2.1	Installation for MS-DOS and WINDOWS 3.1	122
10.2.2	Installation for WINDOWS 95	126
10.2.3	Installation for WINDOWS NT	131
10.2.4	Installation for OS/2 (MonitorMouse)	134

Appendices

A	LCD Specifications and Selection Settings	139
B	Programming the Watchdog Timer	141
	Programming the Watchdog Timer	142
C	Full Disassembly Procedures	145
D	Pin Assignments	153
	IR Connector (J1)	154
	Flat Panel Display Connector (J2)	155
	Flat Panel Display Connector (J3)	156
	Internal COM4 Connector (J4)	156
	Touchscreen Power Connector (J5)	157
	Sandisk SSD Connector (J6)	158
	EIDE Hard Disk Drive Connector (J7)	159
	Floppy Drive Connector (J8)	160
	CD-ROM Connector (J9)	161
	CPU Fan Power Connector (J10)	161
	PCI/ISA Bus Expansion Connector (J11)	162
	Fan Power Connector (J12)	167
	AT Power Connector (J13)	167
	ATX Power Connector (J14) (Reserved)	168
	Internal Speaker Connector (J15)	169
	Inverter Power Connector (J16)	169
	COM2	170
E	Mounting Instructions	171
E.1	Introduction	172
E.2	Panel Mounting	172
E.3	Desktop Stand Mounting	174
E.4	Swingarm Stand Mounting	176

Tables

Table 5-1: Jumpers and their functions	45
Table 5-2: Panel PC connectors	47
Table 5-3: System/PCI clock setting (JP11)	50
Table 5-4: PCI bus clock setting (JP8)	51
Table 5-5: CPU voltage setting (JP13)	52
Table 5-6: CPU frequency ratio (for Intel) (JP14)	54
Table 5-7: CPU frequency ratio (for AMD K6) (JP14)	55
Table 5-8: Clear CMOS/External RTC (JP12)	56
Table 5-9: Cyrix linear mode enable (JP10)	56
Table 5-10: Reset system (JP16)	57
Table 5-11: COM2 RS-232/422/485 setting (JP3, JP4)	58
Table 5-12: COM2 RS-232/422/485 setting (JP5)	58
Table 5-13: PPC-120/140 serial port default settings	59
Table 5-14: COM4/RI pin setting (JP2)	59
Table 5-15: COM3/RI pin setting (JP1)	59
Table 5-16: Panel V _{CC} setting (JP6)	60
Table 5-17: Panel type select (JP9)	61
Table 5-18: Watchdog activity selection (JP15)	63

Table A-1: PPC-120/140 series LCD specifications	140
Table D-1: IR Connector (J1)	154
Table D-2: Flat Panel Display Connector (J2)	155
Table D-3: Flat Panel Display (J3)	156
Table D-4: Internal COM4 Connector (J4)	156
Table D-5: Touchscreen Power Connector (J5)	157
Table D-6: Sandisk SSD Connector (J6)	158
Table D-7: EIDE Hard Disk Drive Connector (J7)	159
Table D-8: Floppy Drive Connector (J8)	160
Table D-9: CD-ROM Connector (J9)	161
Table D-10: CPU Fan Power Connector (J10)	161
Table D-11: PCI/ISA Slot Pin Assignments (Pins A and B)	163
Table D-12: PCI/ISA Slot Pin Assignments (Pins C and D)	164
Table D-13: PCI/ISA Slot Pin Assignments (Pins E and F)	165
Table D-14: PCI/ISA Slot Pin Assignments (Pins G and H)	166
Table D-15: Fan Power Connector (J12)	167
Table D-16: AT Power Connector (J13)	167
Table D-17: ATX Power Connector (J14)	168
Table D-18: Internal Speaker Connector (J15)	169
Table D-19: Inverter Power Connector (J16)	169
Table D-20: COM2	170

Figures

Figure 1-1: The panel PC in perspective	3
Figure 1-2: How to read the PPC-120/140 manual	5
Figure 1-3: Dimensions of the PPC-120/140	10
Figure 2-1: Front view of the panel PC	12
Figure 2-2: Left side view of the panel PC	13
Figure 2-3: Rear view of the panel PC	14
Figure 2-4: Tilted rear view of the panel PC	15
Figure 2-5: Connecting the power cord	16
Figure 2-6: Connecting the keyboard and mouse	17
Figure 3-1: Inserting and ejecting a floppy diskette	22
Figure 3-2: Inserting and ejecting a CD-ROM Disc	23
Figure 3-3: Inserting and ejecting a PCMCIA card	24
Figure 3-4: Using the I/O interface (upper level ports excluding COM ports)	25
Figure 3-5: Using the I/O interface (lower level ports and COM ports)	26
Figure 3-6: PCI/ISA bus expansion	28
Figure 4-1: Disassembling the rear panel of the panel PC	36
Figure 4-2: Installing the primary 2.5" HDD	37
Figure 4-3: Installing the CPU	39
Figure 4-4: Installing the SDRAM	40
Figure 4-5: Installing the FDD	41
Figure 4-6: Installing the CD-ROM drive	42
Figure 5-1: Locating jumpers on the PPC-120/140 motherboard	46
Figure 5-2: Locating connectors on the PPC-120/140 motherboard	48
Figure 9-1: Setup program initial screen	98
Figure 9-2: CMOS setup screen	99
Figure 9-3: BIOS features setup screen	101
Figure 9-4: Chipset features setup screen	104
Figure 9-5: Power management setup screen	105
Figure 9-6: PNP/PCI configuration setup screen	109
Figure 9-7: Load BIOS defaults screen	111
Figure 9-8: Integrated peripherals screen	112
Figure 9-9: IDE HDD auto detecton screen	116
Figure 9-10: Save and exit setup screen	117

Figure C-1: Steps 1 - 4	147
Figure C-2: Steps 5 - 6	149
Figure C-3: Steps 7 - 11	151
Figure E-1: Cutout dimensions of the PPC-120/140	172
Figure E-2: Panel mounting	173
Figure E-3: Desktop stand mounting	175
Figure E-4: Swingarm stand mounting	176

CHAPTER 1

General Information

This chapter gives background information on the PPC-120/140 panel PC.

- Introduction
- How to Use This Manual
- Specifications

1.1 Introduction

The PPC-120/140 panel PC is a multimedia Pentium® MMX processor-based computer that is designed to serve as a human machine interface (HMI) and as a desktop computer. It is a PC-based system with 12.1"/13.8" color TFT or STN LCD display, on-board PCI Ethernet controller, multi-COM port interfaces and a 16-bit audio controller. With built-in CD-ROM drive, floppy drive and PCMCIA expansion sockets, the PPC-120/140 is as compact and user-friendly as a notebook computer. Unlike notebook computers, the PPC-120/140 is more durable and versatile in all applications. The panel PC can be placed on a desktop to replace the traditional desktop computer. In addition, its "fit anywhere" design makes it very flexible and able to be used in many different kinds of installations. It can be wall mounted, panel mounted or stood upright on a desktop.

For system integrators, this simple, complete, compact and highly integrated multimedia system lets you easily build a panel PC into your applications. Common industrial applications include factory automation systems, precision machinery, and production process control. It is also suitable for many nonindustrial applications, including interactive kiosk systems, entertainment management, and car park automation. Our panel PC is a reliable, cost-effective solution to your application's processing requirements.

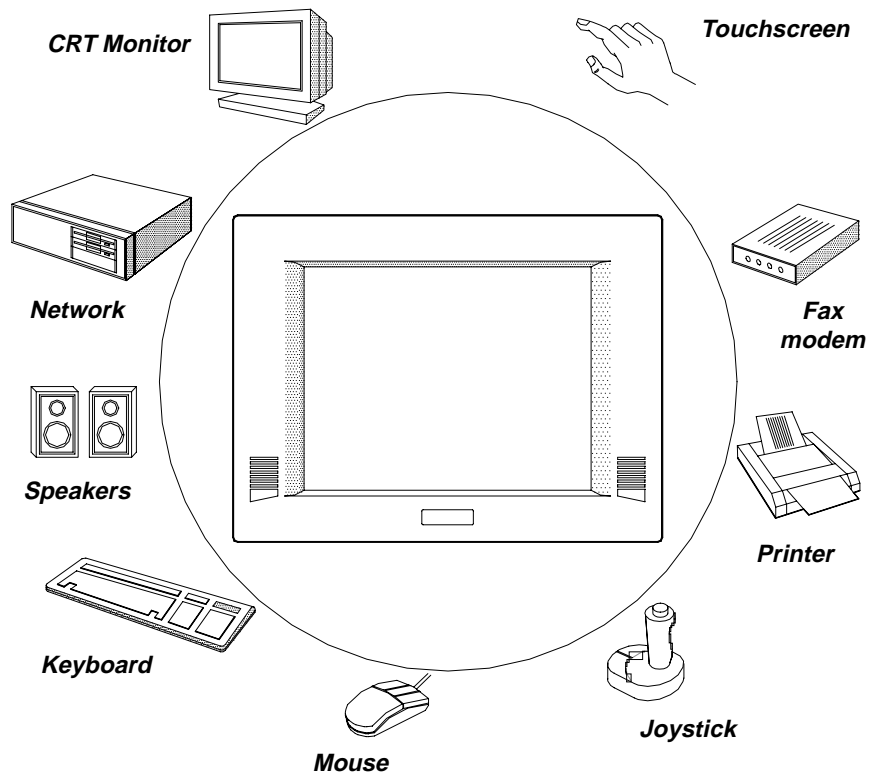

Figure 1-1: The panel PC in perspective

Note: *The illustrations of the panel PC in this manual may differ slightly from the appearance of the panel PC which you have bought. This is because the panel PC product series has two different LCD screen sizes: 12.1" and 13.8".*

1.2 How to Use This Manual

This manual contains all the information you need to set up and use the panel PC. In addition to this manual, you may also want to consult the manuals for your operating system, software applications and peripherals.

Whether you are a new or an experienced user, you will benefit more from this manual if you are familiar with its organization. This manual is divided into ten chapters, plus five appendices.

Chapter 1 (this chapter) outlines the organization of this User's Manual, provides a complete specification description of the PPC-120/140, and summarizes its main features.

Chapter 2 provides step-by-step instructions to help you set up and begin using the panel PC as quickly as possible.

Chapter 3 provides important information about the daily use of the panel PC, including using the CD-ROM drive, floppy drive and enjoying the panel PC's audio capabilities.

Chapter 4 provides detailed step-by-step instructions to help you install the internal key components, including the CPU, hard disk drive, memory module, and so on.

Chapter 5 provides a detailed description of jumper settings and connectors of the motherboard of the PPC-120/140.

Chapter 6 explains the PCI bus Ethernet setup.

Chapter 7 explains the PCI SVGA setup.

Chapter 8 explains the audio setup.

Chapter 9 explains the Award BIOS setup.

Chapter 10 explains how to configure and use the optional touchscreen.

Appendix A details the LCD specifications used in the PPC-120/140.

Appendix B explains how to program the watchdog timer.

Appendix C includes various exploded diagrams of the PPC-120/140. These diagrams will help system integrators disassemble the panel PC.

Appendix D includes all pin assignments on the connectors.

Appendix E helps users install the panel PC, which is mountable in a variety of ways.

If you are a commercial user and the panel PC unit you bought is a complete set with CPU, hard disk drive, SDRAM, CD-ROM drive, floppy disk drive and PCMCIA expansion slots included, you may only need to read Chapters 1 through 3 regarding hardware operation. For additional drivers and BIOS setup information, you should read Chapters 6 through 9. If you want to upgrade your system, you may follow the instructions in Chapters 4 and 5. Chapter 10 is for users who want information about the optional touchscreen. If you are a system integrator who wants to integrate the panel PC into your system, you can refer to Appendices A through E for information such as pin assignments and how to fully disassemble the panel PC.

A suggested guideline for reading this manual is shown below:

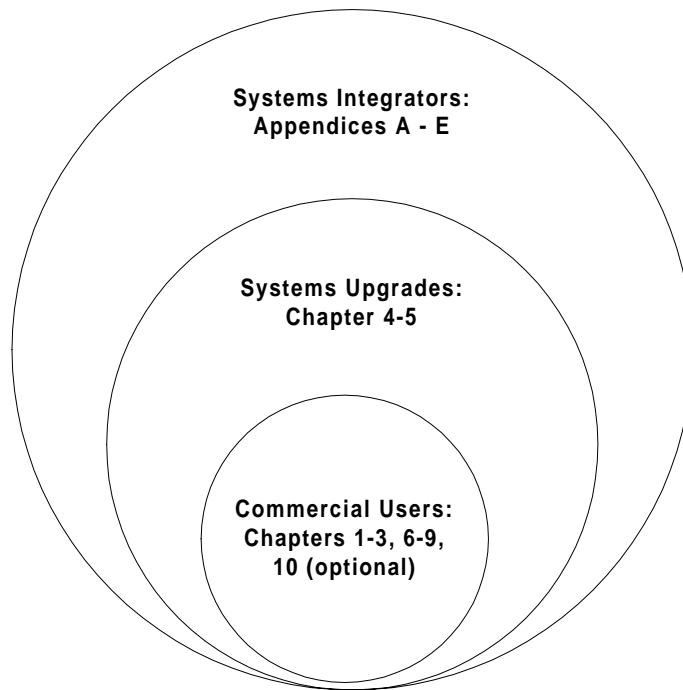

Figure 1-2: How to read the PPC-120/140 manual

1.3 Specifications

General

- **Dimensions (W x H x D):** 375 x 285 x 93.3 mm (14.7" x 11.2" x 3.7")
- **Weight:** 5.2 kg (11.5 lbs)
- **Power supply:**
80 watts
Input voltage: 115 V_{AC} / 3 A ~ 230V_{AC} / 1.5A @ 47 ~ 63 Hz
Output voltage: +5 V @ 12 A, +12 V @ 1 A
- **Cooling fan dimensions (L x W x H):**
40 x 40 x 10 mm (1.6" x 1.6" x 0.4")
- **Disk drive housing:** Space for one 2.5" HDD, one 12.7 mm compact CD-ROM drive, and one slim type 3.5" FDD
- **Front panel:** IP65 protection

Standard PC functions

- **CPU:** Intel Pentium® 75 ~ 233 MHz with MMX, P55C/P54C, AMD K5, K6, Cyrix M1, M2
- **BIOS:** Award 256KB Flash BIOS, supports Plug & Play, APM
- **Chipset:** SiS 5582
- **2nd level cache:** On-board 512 KB Pipeline Burst SRAM
- **RAM:** One 168-pin DIMM socket accepts 16 ~ 128 MB SDRAM (3.3 V)
- **PCI bus master IDE interface:** Supports two connectors. Each connector has one channel and supports two IDE devices. Each channel supports PIO modes 0 ~ 4, DMA mode 0 ~ 2, and Ultra DMA 33 simultaneously. The secondary connector is designated for the CD-ROM drive. BIOS supports IDE CD-ROM boot-up.
- **Floppy disk drive:** Supports up to two FDDs (720K/1.44MB). One built-in FDD included inside FDD housing
- **Parallel port:** One parallel port, supports SPP/EPP/ECP parallel mode. BIOS configurable to LPT1, LPT2, LPT3 or disabled

- **Serial ports:** Four serial ports with three RS-232 ports (COM1, 3, and 4), one RS-232/422/485 port (COM2). All ports are compatible with 16C550 UARTs.
- **Universal serial bus (USB) port:** Supports up to two USB ports
- **PCI/ISA bus expansion slot:** Accepts either one ISA card or one PCI bus card
- **Infrared transceiver:** IrDA 1.1, HP-SIR and Sharp ASK compatible with speeds up to 115.2 Kbps
- **Watchdog timer:** 63-level, interval 1 ~ 63 seconds. Automatically generates system reset or IRQ11 when the system stops due to a program error or EMI. Jumperless selection and software enabled/disabled
- **Battery:** 3.0 V @ 190 mA lithium battery

PCI SVGA/flat panel interface

- **Chipset:** C&T 65555
- **Display memory:** 2 MB on-board memory, supports up to 4 MB
- **Display type:** Simultaneously supports CRT and flat panel displays (EL, LCD and gas plasma)
- **Display resolution:** Supports non-interlaced CRT and LCD displays up to 1024 x 768 @ 65536 colors. If display memory is expanded to 4 MB, supports CRT and LCD displays up to 1280 x 1024 with true-color resolution.

Audio function

- **Chipset:** ESS 1869
- **Audio controller:** 16-bit codec, Full-Duplex stereo single-chip audio solution
- **Stereo sound:** 100% DOS GAME compatible (Sound Blaster or Sound Blaster Pro)
- **Audio interface:** Microphone in, line in, line out and game port.

PCI bus Ethernet interface

- **Chipset:** Realtek RTL 8139 PCI local bus Ethernet controller
- **Ethernet interface:** Full compliance with IEEE 802.3u 100Base-T and 10 Base-T specifications. Includes software drivers and boot ROM
- **100/10Base-T auto-sensing capability**

Touchscreen (optional)

- **Type:** Analog resistive
- **Resolution:** Continuous
- **Light transmission:** 75% (surface meets ASTM-D-1044 standard, Taber abrasion test)
- **Controller:** RS-232 interface (uses COM4)
- **Power consumption:** +5 V @ 200 mA
- **Software driver:** Supports DOS, Windows 3.1, Windows 95, Windows NT 4.0 and OS/2
- **Durability:** 30 million touches lifetime

Note: The panel PC with the optionally installed touchscreen will share COM4. Once the touchscreen is installed, COM4 cannot be used for other purposes.

Optional modules

- **CPU:** Intel Pentium® 75 ~ 233 MHz with MMX, P55C/P54C, AMD K5, K6, Cyrix M1, M2
- **Memory:** 16/32/64/128 MB SDRAM
- **HDD:** 2.5" HDD
- **Touchscreen:** Analog resistive or analog capacitive
- **CD-ROM drive:** Compact 24X CD-ROM or above
- **PCMCIA interface:** Complies with 1995 PCMCIA card standard. Supports two PCMCIA card/CardBus slots. Two sockets support both a 16-bit PCMCIA card and a 32-bit CardBus simultaneously. Hot insertion and removal

Note 1: The PCMCIA driver is an option which does not come with the PCMCIA interface. For more information, contact your local dealer or our sales representative.

Note 2: Microsoft's new operating system, Windows 98, supports the PCMCIA function.

Environment

- **Temperature:**
0° ~ 40° C (32° ~ 113° F) for panel PC with DSTN LCD
0° ~ 45° C (32° ~ 122° F) for panel PC with TFT LCD
- **Relative humidity:** 10 ~ 95% @ 40° C (non-condensing)
- **Shock:** 10G peak acceleration (11 msec duration)
- **Power MTBF:** 50,000 hrs
- **Certification:** Passed CE, FCC Class B, VCCI certification; meets UL

1.4 Dimensions

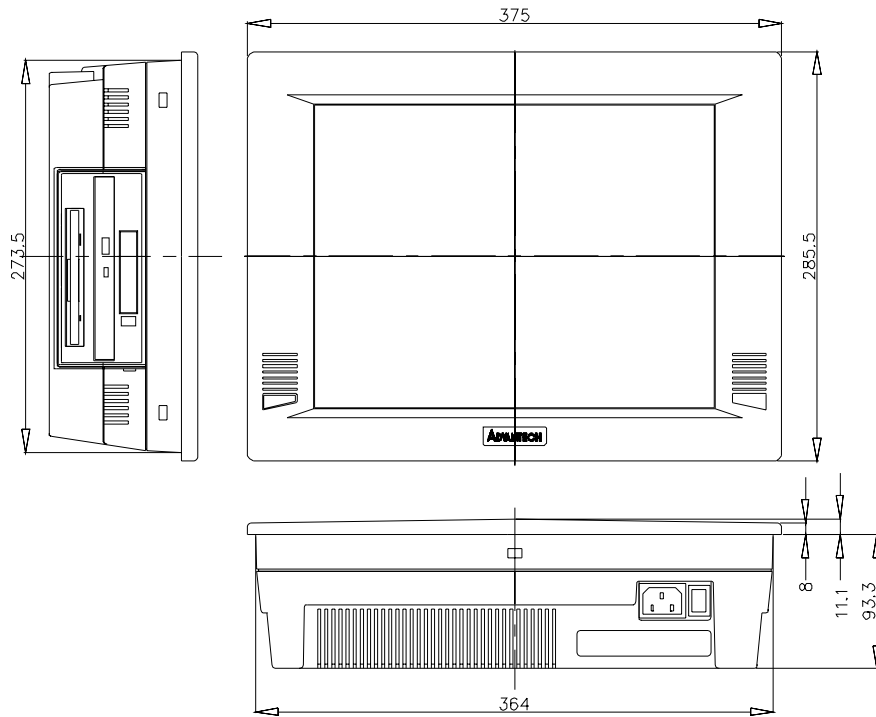

Figure1-3: Dimensions of the PPC-120/140

CHAPTER 2

System Setup

- A Quick Tour of the Panel PC
- Preparing for First-time Usage
- Running the Setup Program
- Installing the System Software
- Installing the Drivers

2.1 A Quick Tour of the Panel PC

Before you start to set up the panel PC, take a moment to become familiar with the locations and purposes of the controls, drives, connectors and ports, which are illustrated in the figures below.

When you place the panel PC upright on the desktop, its front panel appears as shown in Figure 2-1. The size of your panel PC's liquid crystal display (LCD) varies according to the model that you purchased.

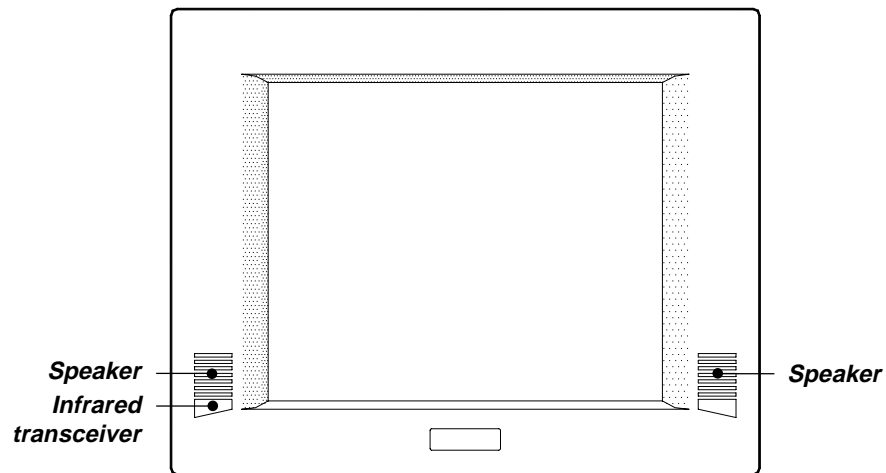

Figure 2-1: Front view of the panel PC

When you look at the left side of the panel PC, you will see the floppy disk drive, CD-ROM drive and PCMCIA expansion sockets, as shown in Fig. 2-2.

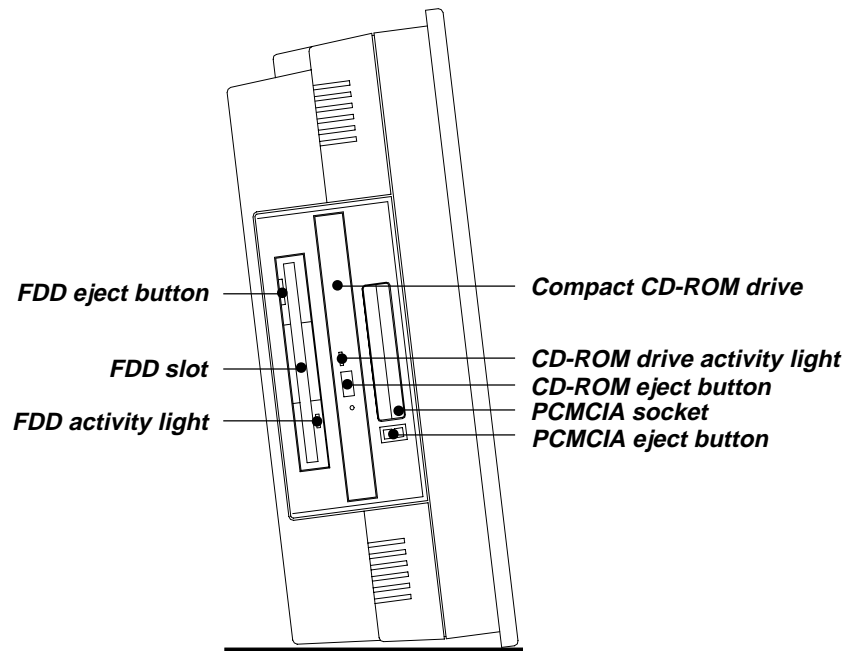

Figure 2-2: Left side view of the panel PC

When you turn the panel PC around and look at its rear cover, you will find the PCI/ISA expansion slot located on the left side. This slot is covered by a side panel cover. The sunken I/O section is at the bottom of the panel PC, as shown in Fig. 2-3. (The I/O section includes various I/O ports, including serial ports, parallel port, the Ethernet port, USB ports, the microphone jack, and so on.)

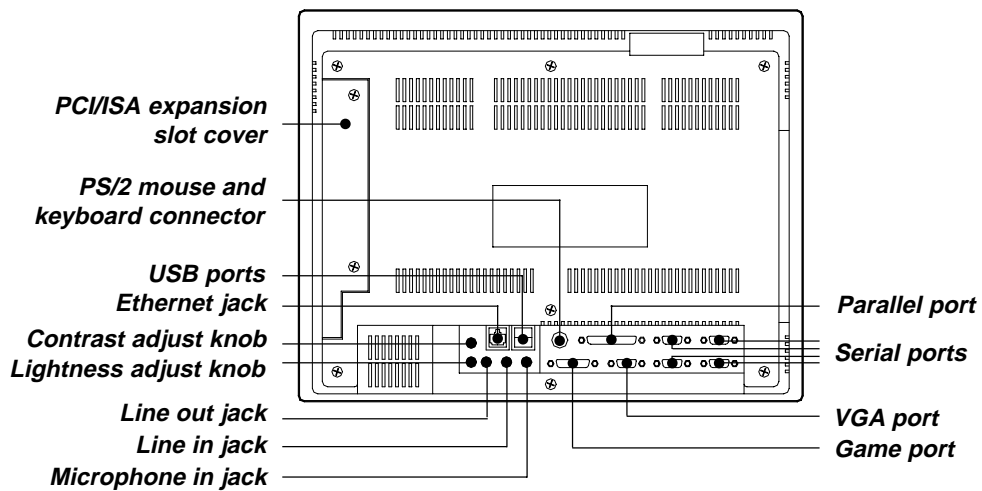

Figure 2-3: Rear view of the panel PC

Figure 2-4 shows the I/O section and power switch of the panel PC.

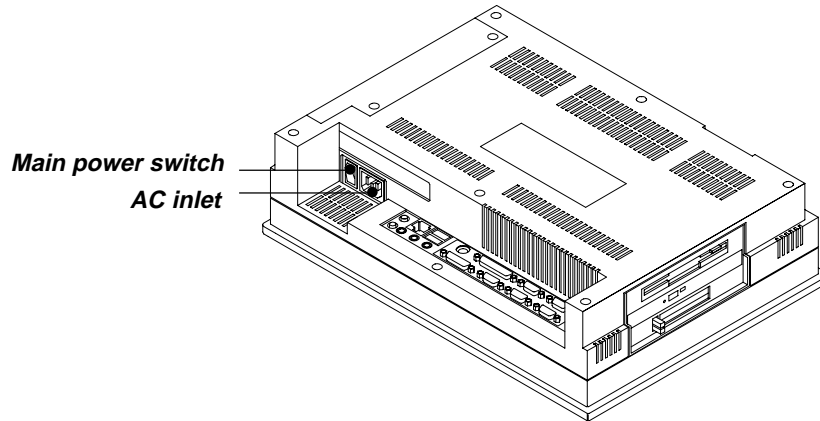

Figure 2-4: Tilted rear view of the panel PC

2.2 Preparing For First-time Use

Before you start to set up the panel PC system, you should have at least the following items ready:

- Power cord (in the accessory box)
- Y-shaped connector (in the accessory box)
- AT keyboard
- PS/2 or serial mouse (for system software installation i.e. Microsoft Windows, NT, etc.)

2.3 Installation Procedures

2.3.1 Connecting the power cord

The panel PC can only be powered by an AC electrical outlet (90 ~ 240 volts, 50 ~ 60 Hz). Be sure to always handle the power cords by holding the plug ends only.

Follow these procedures in order:

1. Connect the female end of the power cord to the AC inlet of the panel PC. (See Fig. 2-5.)
2. Connect the 3-pin male plug of the power cord to an electrical outlet.

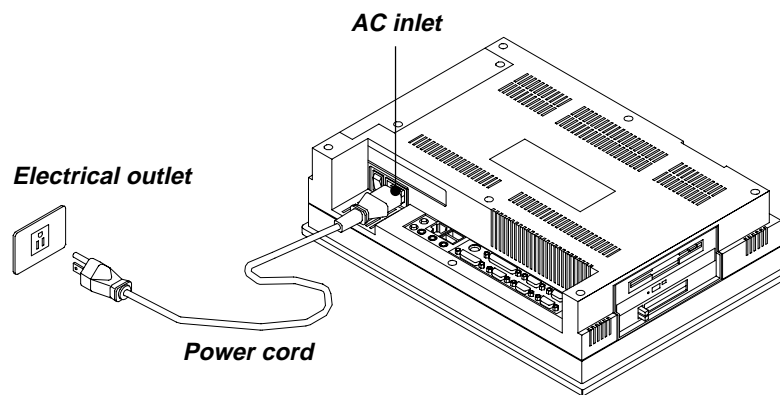

Figure 2-5: Connecting the power cord

2.3.2 Connecting the keyboard and mouse

1. Connect the Y-shaped adapter to the PS/2 mouse and keyboard port on the I/O section of the panel PC. (See Fig. 2-6.)
2. Connect the PS/2 mouse and keyboard to the Y-shaped adapter. (See Fig. 2-6.)

If you use a serial mouse and your panel PC has a touchscreen, you can connect the mouse to any COM port except COM4.

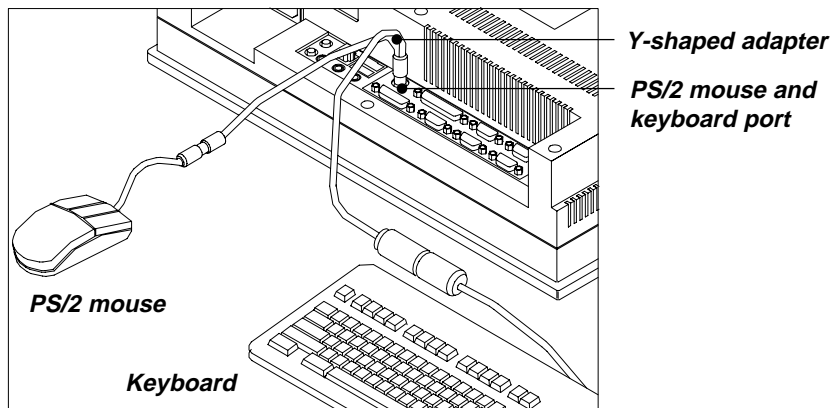

Figure 2-6: Connecting the keyboard and mouse

2.3.3 Switching on the power

Switch on the power switch on the rear cover. (See Fig. 2-4.)

2.4 Running the BIOS Setup Program

Your panel PC is likely to have been properly set up and configured by your dealer prior to delivery. You may still find it necessary to use the panel PC's BIOS (Basic Input-Output System) setup program to change system configuration information, such as the current date and time or your type of hard drive. The setup program is stored in read-only memory (ROM). It can be accessed either when you turn on or reset the panel PC, by pressing the "Del" key on your keyboard immediately after powering on the computer.

The settings you specify with the setup program are recorded in a special area of memory called CMOS RAM. This memory is backed up by a battery so that it will not be erased when you turn off or reset the system. Whenever you turn on the power, the system reads the settings stored in CMOS RAM and compares them to the equipment check conducted during the power on self-test (POST). If an error occurs, an error message will be displayed on screen, and you will be prompted to run the setup program.

If you want to change the setup of BIOS, refer to Chapter 9 for more detailed information.

2.5 Installing System Software

Recent releases of operating systems from major vendors include setup programs which load automatically and guide you through hard disk preparation and operating system installation. The guidelines below will help you determine the steps necessary to install your operating system on the panel PC hard drive.

Note: Some distributors and system integrators may have already pre-installed system software prior to shipment of your panel PC.

If required, insert your operating system's installation or setup diskette into the diskette drive until the release button pops out. (See Fig. 3-1.)

The BIOS of the panel PC supports system boot-up directly from the CD-ROM drive. You may also insert your system installation CD-ROM into the CD-ROM drive. (See Fig. 3-2.) Refer to Chapter 9 - BIOS Setup if you wish to change the BIOS settings.

Power on your panel PC or reset the system by pressing the "Ctrl"+"Alt"+"Del" keys simultaneously. The panel PC will automatically load the operating system from the diskette or CD-ROM.

If you are presented with the opening screen of a setup or installation program, follow the instructions on screen. The setup program will guide you through preparation of your hard drive, and installation of the operating system.

If you are presented with an operating system command prompt, such as A:\>, then you must partition and format your hard drive, and manually copy the operating system files to it. Refer to your operating system user's manual for instructions on partitioning and formatting a hard drive.

2.6 Installing the Drivers

After installing your system software, you will be able to set up the Ethernet, SVGA, audio, and touchscreen functions. All the drivers except the CD-ROM drive driver are stored in a CD-ROM disc entitled "Drivers and Utilities". The CD-ROM drive driver is stored in a floppy disk. Both the CD-ROM and the floppy disk can be found in your accessory box.

To set up the CD-ROM function, insert the floppy disk with the CD-ROM drive driver into the floppy disk drive and type "install" after the following prompt is displayed on screen:

A: > INSTALL

Press "Enter", and the installation process will be completed in a few seconds.

The standard procedures for installing the Ethernet, SVGA, audio, and touchscreen drivers are described in Chapters 6, 7, 8 and 10 respectively.

For your reference, the directory of drivers on the "Drivers and Utilities" CD-ROM is:

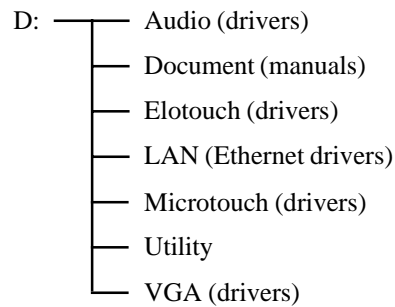

The utility directory includes multimedia programs. Refer to the README.TXT file inside the BIOS folder for more detailed information.

The various drivers and utilities in the CD-ROM disc have their own text files which help users install the drivers and understand their functions. These files are a very useful supplement to the information in this manual.

Note: *The drivers and utilities used for the PPC-120/140 panel PCs are subject to change without notice. If in doubt, check Advantech's web site or contact our application engineers for the latest information regarding drivers and utilities.*

CHAPTER 3

Using the Panel PC

- Floppy Drive
- CD-ROM Drive
- PCMCIA Sockets
- PS/2 Mouse and Keyboard
- Audio Interface
- PCI/ISA Bus Expansion
- Parallel Port
- Serial COM Ports
- VGA Port
- Game Port
- USB Ports
- Audio Interface
- Ethernet
- Adjusting the LCD Contrast and Brightness (STN)
- Infrared Module
- Touchscreen (Optional)

3.1 Introduction

This chapter describes basic features and procedures for using the panel PC. Topics covered include the floppy drive, CD-ROM drive, I/O ports, touchscreen, and so on.

3.2 Floppy Drive

To insert a diskette, hold it with your left hand, between your thumb and your other fingers, and push it toward the drive. (See Fig. 3-1.) Slide the disk until it clicks into place. Note that new diskettes must be formatted by your operating system before you can use them for data storage. See your operating system manual for details.

To eject a diskette, first ensure that the drive activity light is off, and then press the eject button on the drive. When the diskette pops out of the drive, remove it and store it properly.

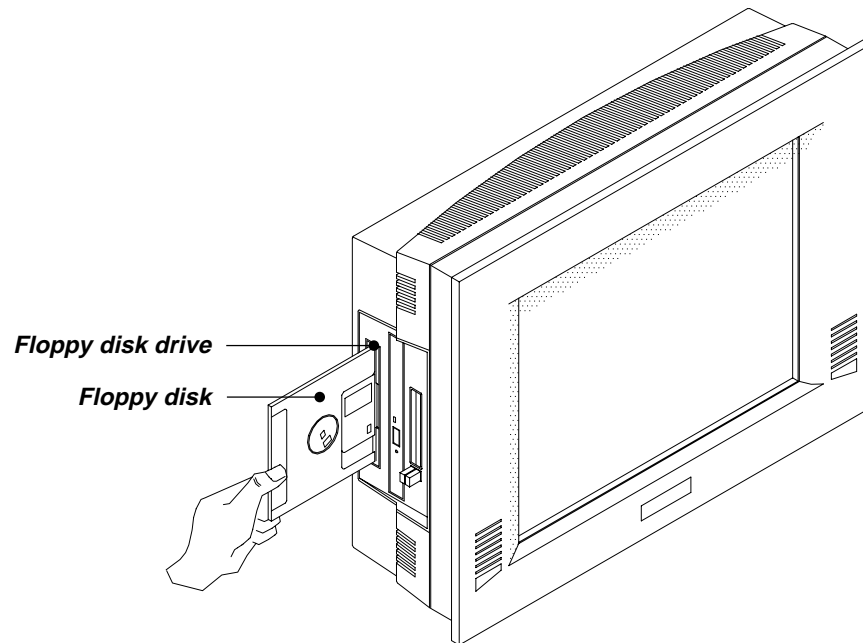

Figure 3-1: Inserting and ejecting a floppy diskette

3.3 CD-ROM Drive

To insert a CD-ROM disc, press the eject button of the CD-ROM drive. The yellow activity light will flash and the front panel will come out a short distance. Using your fingertips, hold the top and bottom of the front panel and pull it outward to the very end. (See Fig 3-2.) Align the center hole of the CD-ROM disc with the center circle of the CD-ROM holding plate. Press the transparent ring around the center hole of the CD-ROM until you hear a click. Push the front panel of the CD-ROM drive back to its original place.

To eject a CD-ROM disc, first ensure that the drive activity light is off. Then press the eject button on the drive. When the disc pops out of the drive, remove it and store it properly.

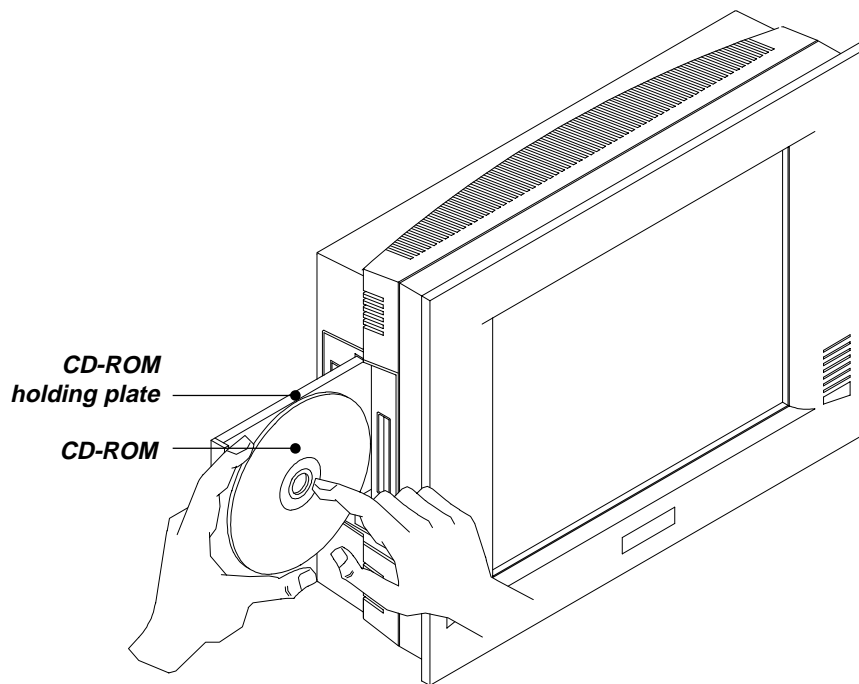

Figure 3-2: Inserting and ejecting a CD-ROM disc

3.4 PCMCIA

PCMCIA cards are inserted and ejected in much the same way as diskettes.

To insert a PCMCIA card, align the card with the socket and slide the card into the socket until it locks into place. Note that some PCMCIA memory cards must be prepared by your operating system before you can use them for data storage. See your PCMCIA card manual for details.

To eject a PCMCIA card, first ensure that the panel PC is not accessing the memory card or device. Then press the appropriate eject button on the socket. When the card pops out of the socket, remove it and store it properly.

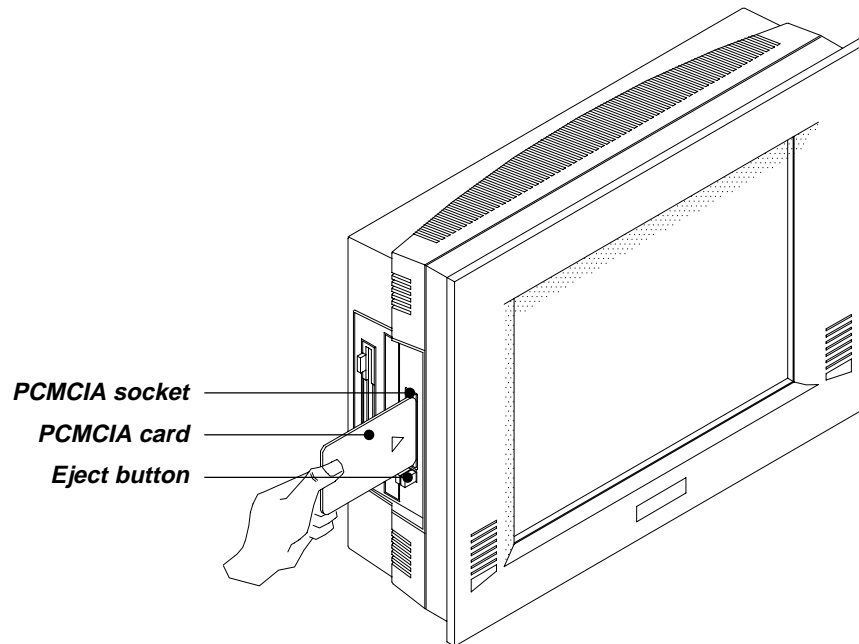

Figure 3-3: Inserting and ejecting a PCMCIA card

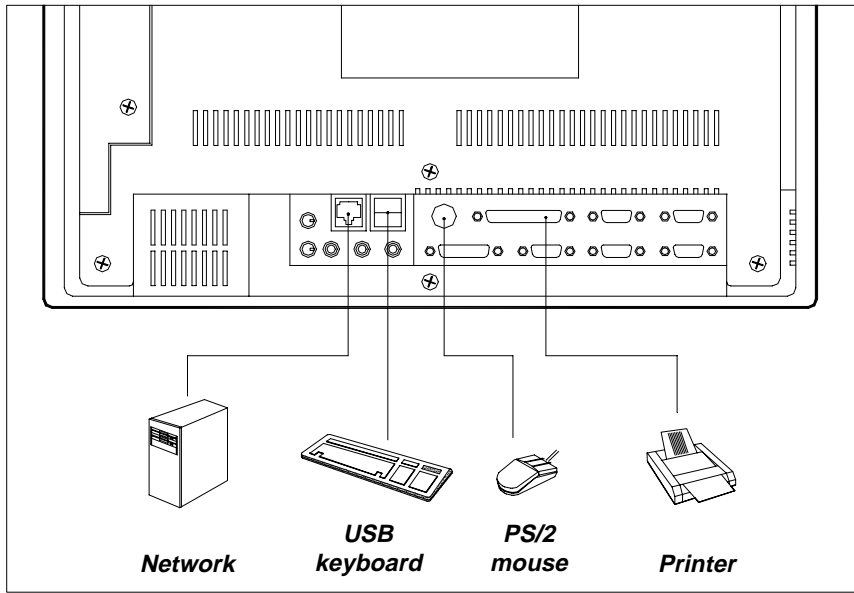

Figure 3-4: Using the I/O interface (upper level ports excluding COM ports)

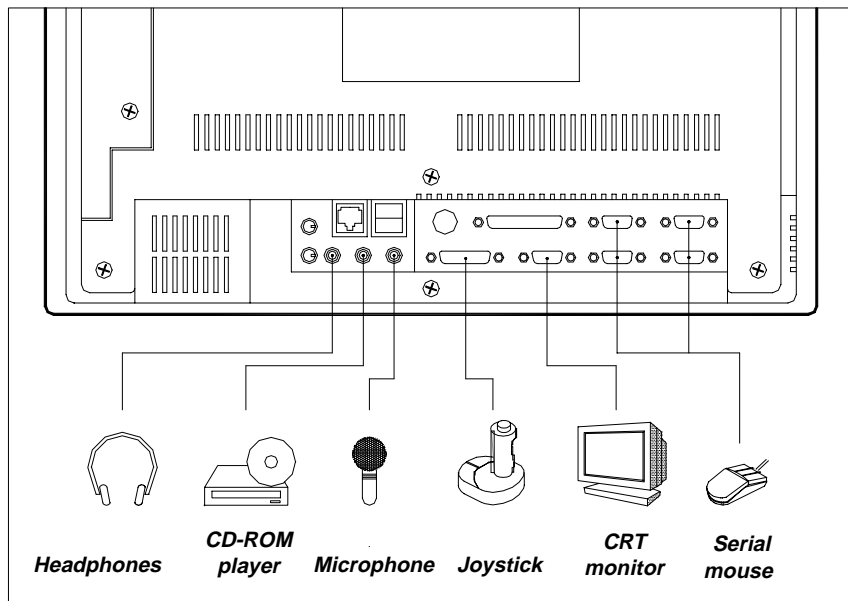

Figure 3-5: Using the I/O interface (lower level ports and COM ports)

3.5 PS/2 Mouse and Keyboard

If you wish to use a full-size desktop keyboard and PS/2 mouse with your panel PC, follow these instructions:

1. Be sure the panel PC is turned off.
2. Connect the Y-shaped adapter to the PS/2 mouse and keyboard port on the rear bottom side of the rear cover. (See Fig. 3-4 and Fig. 2-6.)
3. Attach the keyboard to the 5-pin port of the Y-shaped adapter.
4. Attach the PS/2 mouse to the 6-pin female PS/2 port of the Y-shaped adapter.
5. Turn on the panel PC.

3.6 PCI/ISA Bus Expansion

The panel PC supports PCI and ISA bus expansion cards. To integrate a new PCI or ISA bus card into your system, follow these instructions:

1. Turn off the panel PC.
2. Unscrew the two screws on the top of the PCI/ISA bus expansion slot cover, and remove this cover.
3. Remove the metal plate by unscrewing the single attaching screw.
4. Insert the PCI or ISA bus card into the PCI/ISA slot of the riser card. (See Fig. 3-6 overleaf.)
5. Run the setup program within your operating system to configure your system.

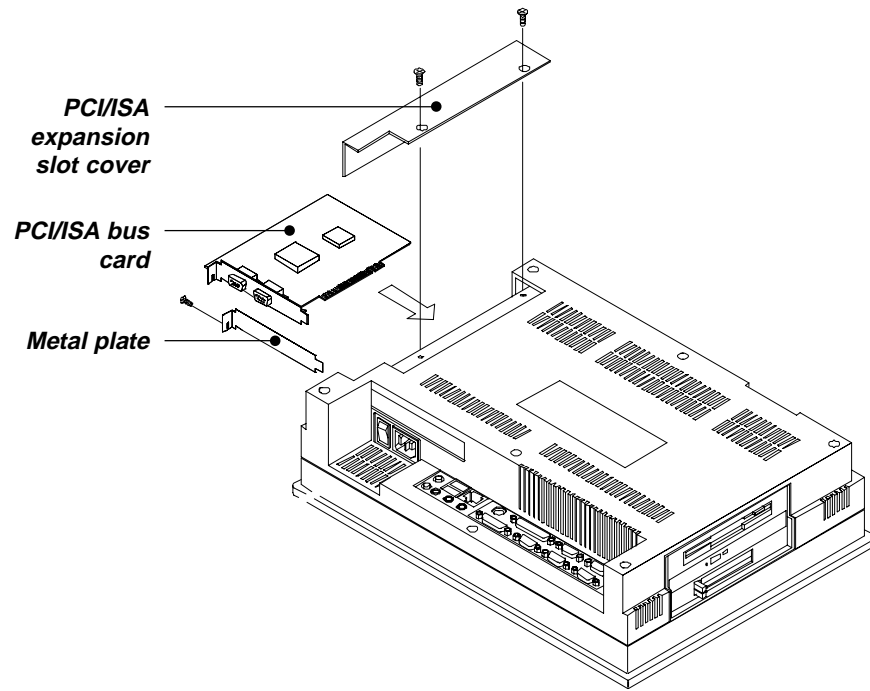

Figure 3-6: PCI/ISA bus expansion

3.7 Parallel Port

The panel PC supports the latest EPP and ECP parallel port protocols for improved performance and versatility with compatible printers or other devices.

To connect the panel PC to a printer or other devices:

1. Be sure both the panel PC and the printer/devices are turned off.
2. Connect the 25-pin male connector of the printer cable to the 25-pin female port on the panel PC labelled "parallel port".
3. If necessary, attach the other end of your printer cable to your printer, and fasten any retaining screws. A typical parallel printer connection is illustrated in Fig. 3-4.
4. Turn on the printer and any other peripheral devices you may have connected to the panel PC, and then turn on the panel PC.
5. If necessary, run the panel PC's BIOS setup program to configure the parallel port to respond as required by your printer and software operating environment.

3.8 Serial COM Ports

There are four serial COM ports on the bottom of the rear cover. You can easily attach a serial device to the panel PC, such as an external modem or mouse. Follow these instructions:

1. Be sure the panel PC and any other peripheral devices you may have connected to the panel PC are turned off.
2. Attach the interface cable of the serial device to the panel PC's serial port. (See Fig. 3-5.) If necessary, attach the other end of the interface cable to your serial device. Fasten any retaining screws.
3. Turn on any other peripheral devices you may have connected to the panel PC, and then turn on the panel PC.
4. Refer to the manual(s) which accompanied your serial device(s) for instructions on configuring your operating environment to recognize the device(s).
5. Run the BIOS setup program and configure the jumper settings to change the mode of the COM ports. (See Section 5.3.)

3.9 VGA Port

An external VGA-compatible device may be connected to the system through the 15-pin external port located on the rear of the system unit. The panel PC simultaneously supports an external CRT monitor in addition to its own LCD display.

1. Be sure the panel PC is turned off.
2. Connect the external monitor to the system. (See Fig. 3-5.)
3. Turn on the panel PC and the external monitor.

3.10 Game Port

An external game device may be connected to the system through the 15-pin external port located on the rear of the system unit.

1. Be sure the panel PC is turned off.
2. Connect the external joystick or game device to the system. (See Fig. 3-5.)
3. Turn on the panel PC and the external joystick or game device (if applicable).
4. Install the driver before you use the joystick or game device.

3.11 USB Ports

An external USB device may be connected to the system through the 4-pin USB ports located on the rear side of the system unit.

1. Connect the external device to the system. (See Fig. 3-4.)
2. The USB ports support hot plug-in connection. You should install the device driver before you use the device.

3.12 Audio Interface

The audio interface includes three jacks: microphone in, line out and line in. (See Fig. 3-5.) Their functions are:

Microphone in: Use an external microphone to record voice and sound.

Line out: Output audio to external devices such as speakers or earphones. The built-in speaker will not be disabled when the line out jack is connected to external audio devices.

Line in: Input audio from an external CD player or radio.

1. Connect the audio device to the system. (See Fig. 3-5.)
2. Install the driver before you use the device.

3.13 Ethernet

External devices on your network may be connected to the system through the external ethernet port located on the rear side of the system unit.

1. Be sure the panel PC is turned off.
2. Connect the external device(s) to the panel PC. (See Fig. 3-4.)
3. Turn on the panel PC and the external device(s).
4. Under DOS, run the RSET8139 program to check the hardware network status before installing the Ethernet driver.
5. Run the Ethernet driver to connect up to the network.

3.14 Adjusting the LCD Contrast and Brightness

The contrast control knob allows you to adjust the contrast of the LCD display panel. Only panel PCs with DSTN LCD displays have this function.

The brightness control knob allows you to adjust the brightness of the LCD display panel.

3.15 Infrared Module

This sensor on the front panel supports the optional wireless transmitting and receiving of infra-red data. (See Fig. 2-1.) You must configure the setting through the BIOS setup (chipset features) to select whether UART2 is directed for use with COM2 or IrDA.

1. Place the panel PC and the infrared transceiving device (eg. printer) with their IrDA ports facing each other at the same horizontal level. The distance between the two IrDA ports should not exceed 1 meter (38").
2. Run the infrared transceiving function on the panel PC. (The function is supported by various operating systems and application software.)
3. The transceiving device also needs to run its infrared transceiving driver to receive or transmit data.

3.16 Touchscreen (Optional)

The touchscreen is connected to COM4. Its function is similar to that of a mouse. The only difference is that you put your fingertip on the screen to move the cursor.

You will need to install the touchscreen driver before it will work. The touchscreen drivers for various operating systems are stored on the CD-ROM disc inside the accessory box. The touchscreen manual can also be found on this disc. Read Chapter 10 of this manual carefully before you install the driver.

CHAPTER 4

Hardware Installation and Upgrading

- Overview of Hardware Installation and Upgrading
- Disassembling the Panel PC
- Installing the 2.5" Hard Disk Drive (HDD)
- Installing the Central Processing Unit (CPU)
- Installing the SDRAM Memory Module
- Installing the Floppy Disk Drive (FDD)
- Installing the CD-ROM Drive

4.1 Overview of Hardware Installation and Upgrading

The panel PC consists of a PC-based computer that is housed in a plastic rear panel and a shielding case. Your HDD, SDRAM, power supply, CPU, and so on are all readily accessible by removing the rear panel and shielding case. Any maintenance or hardware upgrades can be easily completed after removing the rear panel and shielding case.

If you are a systems integrator and need to know how to completely disassemble the panel PC, you can find more useful information in Appendix C.

Warning! *Do not remove the rear cover until you have verified that no power is flowing within the panel PC. Power must be switched off and the power cord must be unplugged. Every time you service the panel PC, you should be aware of this.*



4.2 Disassembling the Panel PC

The following are standard procedures for disassembling the panel PC before you upgrade your system. All procedures are illustrated in Fig. 4-1.

1. Unscrew the seven screws that secure the rear cover, then remove the cover.
2. Unscrew the two screws of the PCI/ISA expansion PCB, and remove it.
3. Unscrew the four screws that secure the CPU cover.
4. Remove the floppy drive, HDD, and CD-ROM cables; then remove the side panel.
5. Unscrew the ten screws of the shielding case, and remove it.
6. Detach the ventilation fan power cable.

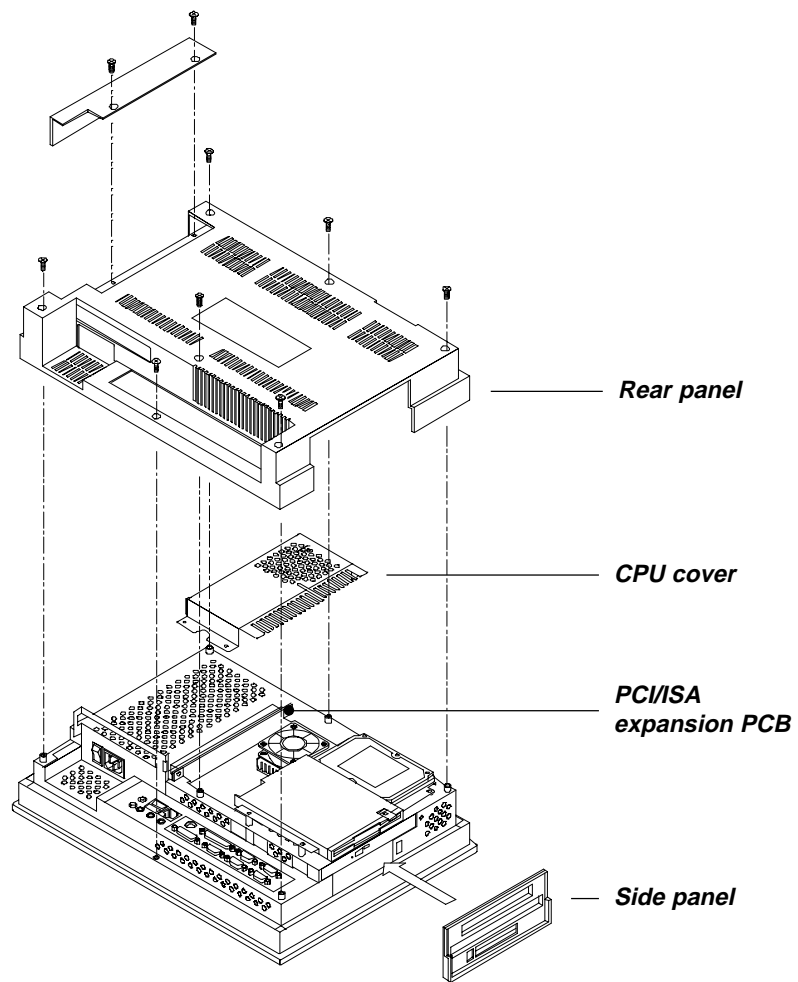

Figure 4-1: Disassembling the rear panel of the panel PC

4.3 Installing the 2.5" Hard Disk Drive (HDD)

You can attach one enhanced Integrated Device Electronics (IDE) hard disk drive to the panel PC's internal controller which uses a PCI local-bus interface. The advanced IDE controller supports faster data transfer and allows the IDE hard drive to exceed 528 MB. The following are instructions for installation:

1. Detach and remove the rear cover and side panel.
2. There is a metal plate holding the HDD on the upper right-hand side of the shielding case. (See Fig. 4-2.) Remove the two screws on the metal plate.
3. Push the metal plate to the right and remove it from the two lugs of shielding case.
4. Place the HDD on the metal plate, and tighten the four screws from the bottom of the metal plate.
5. The HDD cable (1 x 44-pin to 1 x 44-pin) is next to the metal plate. Connect the HDD cable to the HDD. The another end of the HDD cable is connected to the PC board (J7). Make sure that the red/blue wire corresponds to Pin 1 on the connector, which is labeled on the board. Plug the other end of the cable into the IDE hard drive, with Pin 1 on the cable corresponding to Pin 1 on the hard drive.

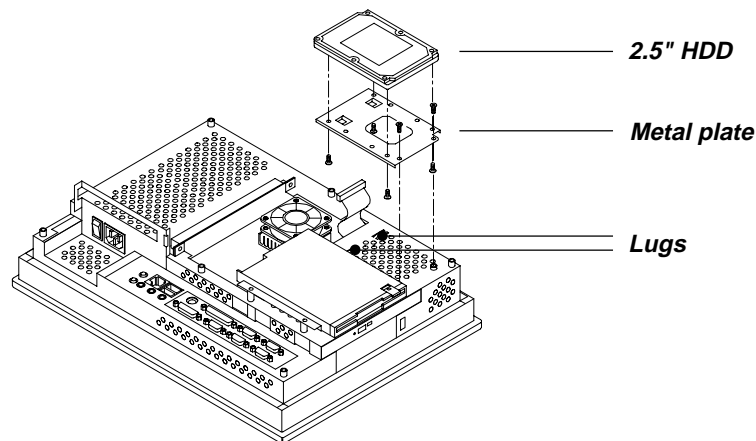

Figure 4-2: Installing the primary 2.5" HDD

4.4 Installing the Central Processing Unit (CPU)

The panel PC's central processing unit (CPU) can be upgraded to improve system performance. The panel PC provides one 321-pin ZIF (Zero Insertion Force) socket (Socket 7) which is backward compatible with ZIF Socket 5 processors. The CPU must come with an attached heatsink and CPU fan to prevent overheating. The panel PC comes with one CPU fan with a unique connector in the accessory box.

Warning! *The CPU may be damaged if operated without a heatsink and a fan.*



Warning! *Always disconnect the power cord from your panel PC when you are working on it. Do not make connections while the power is on as sensitive electronic components can be damaged by the sudden rush of power. Only experienced electronics personnel should open the panel PC.*



1. Detach and remove the rear cover, shielding case and side panel.
2. Detach the flat cables of the HDD, FDD and CD-ROM drives.
3. Unscrew the ten screws of the shielding case and remove the case.
4. Locate the ZIF socket and open it by first pulling the lever sideways away from the socket, then upwards at an angle of 90 degrees.
5. Insert the CPU with the correct orientation. The notched corner of the CPU (with the white dot) should point towards the end of the lever. The end of the lever is the blank area where one hole is missing from the corner of the square array of pin holes. An arrowhead printed on the motherboard points to the end of the lever. (See Fig. 4-3 overleaf.)
6. Slide the CPU in gently. It should insert easily. If not, pull the lever up a little more and make sure the pins of the CPU correspond with the holes of the socket. **DO NOT USE EXCESSIVE FORCE!**
7. Press the lever down. The plate will slide forward.
8. Place the heatsink on top of the CPU and tighten it with the heatsink clip (shown in Fig. 4-3).
9. Attach the CPU fan to the CPU heatsink with the four screws.

10. Connect the power cable of the CPU fan to the 2-pin connector (J12).
11. After changing the CPU, you must set jumpers, including those for the PCI bus clock (JP8), system/PCI clock (JP11), frequency ratio (JP14), and voltage (JP13). (See Section 5.2.)
12. To remove the CPU, pull the lever out to the side a little and raise it as far as it will go. Lift out the CPU chip.

NOTE! When you install a new CPU, be sure to adjust the board jumper settings. Improper settings may damage the CPU. (See Chapter 5 for jumper settings.)

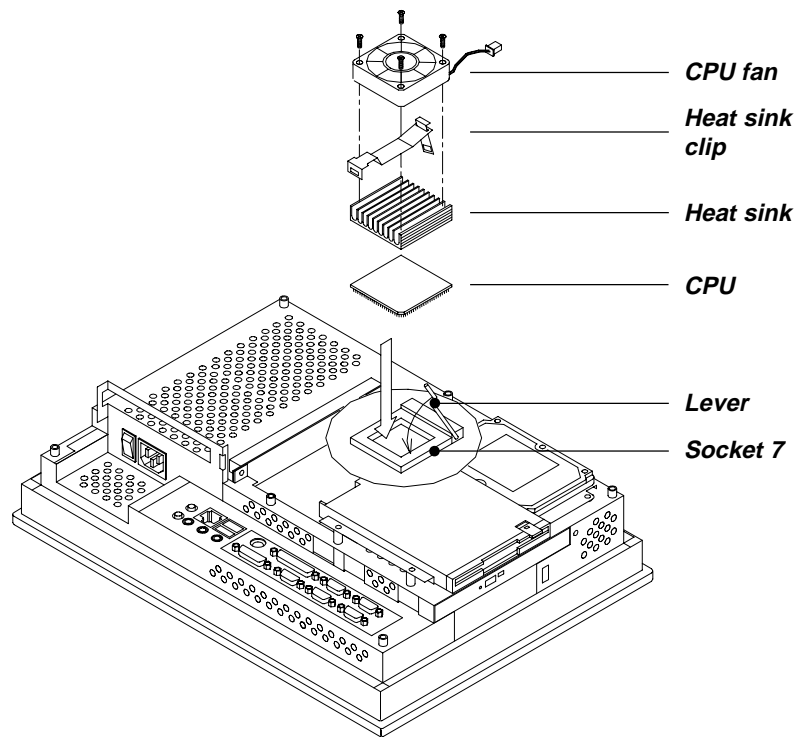

Figure 4-3: Installing the CPU

4.5 Installing the SDRAM Memory Module

You can install from 16 MB to 128 MB of SDRAM memory. The panel PC system provides one 168-pin DIMM (Double Inline Memory Module) socket and supports 3.3 V SDRAM with a minimum speed of 12 ns.

Note: *The module can fit into the socket only one way. Pin 1 of the DIMM module must line up with the small arrowhead printed on the motherboard next to the DIMM socket. The golden pins of the module must point down into the DIMM socket.*

1. Detach and remove the rear cover and CPU cover.
2. Push the two white eject levers on each side of the DIMM outward until they are separated from the black vertical posts. (See Fig. 4-4.)
3. Insert the memory module into the socket at an angle of 90 degrees.
4. Push the two eject levers towards the vertical posts at each end of the socket until the module is upright.

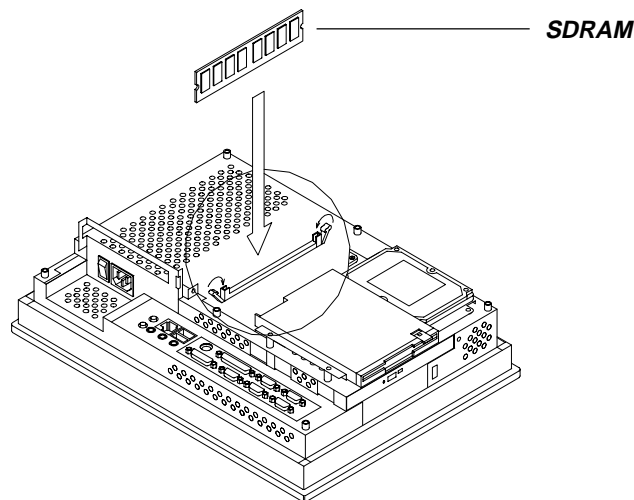

Figure 4-4: Installing the SDRAM

4.6 Installing the Floppy Disk Drive (FDD)

Installation of a floppy disk drive is similar to that for a hard disk drive. The metal plate for holding the FDD is on the left side of the shielding case. The 26-pin yellow FPC cable is for connecting the FDD. Only 3.5" floppy disk drives (720 KB and 1.44 MB) can be attached to the metal plate.

1. Detach and remove the rear cover and side panel.
2. There is a metal plate for holding the FDD on the right side of the shielding case. (See Fig. 4-5.) Unscrew the two screws on the upper side of the metal plate.
3. Push the metal plate to the right and remove it from the two lugs of the shielding case.
4. Place the FDD on the metal plate. Tighten the four smaller screws located on each side of the metal plate.
5. Connect the yellow FDD cable (26-pin to 26-pin) which is next to the metal plate of the FDD. The other end of the FDD cable is connected to connector J8 on the PC board.
6. Attach the two screws of the metal plate to the original hole.

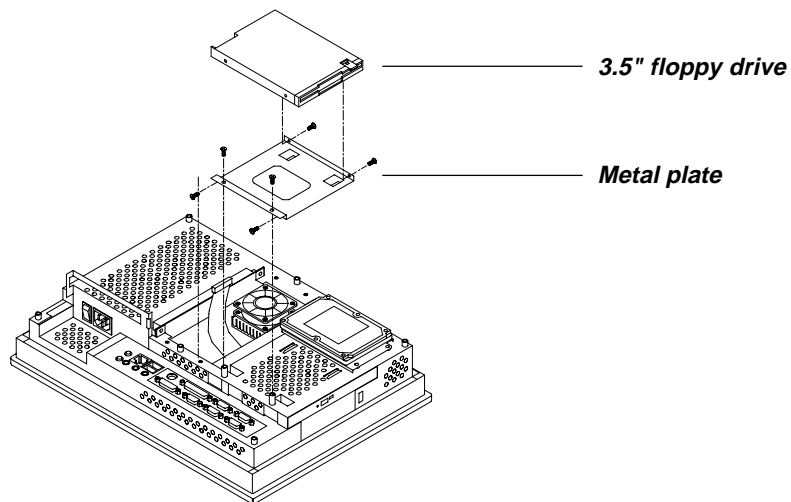

Figure 4-5: Installing the FDD

4.7 Installing the CD-ROM Drive

The compact CD-ROM drive used in the panel PC is not the common 5.25" CD-ROM drive seen in computer shops. It is the kind widely used in notebook computers. Install the CD-ROM drive as follows:

1. Detach and remove the rear cover, side panel and CPU cover.
2. Fasten the retaining clip on the CD-ROM drive with the two screws.
3. Slide the slim CD-ROM drive into the CD-ROM slot. (See Fig. 4-6.)
4. Attach the two screws on the side panel of the CD-ROM slot.
5. Connect the 40-pin CD-ROM cable (which has a small converting PCB at its end) to the CD-ROM drive. The other end of the cable is connected to CD-ROM connector J9 on the motherboard.
6. Rotate the retaining spring, to secure the CD-ROM connector (with converting PCB) in place.

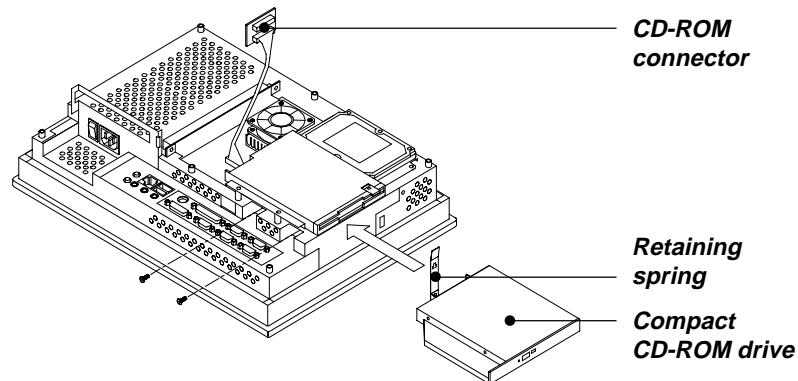

Figure 4-6: Installing the CD-ROM drive

CHAPTER 5

Jumper Settings and Connectors

This chapter tells how to set up the panel PC hardware, including instructions on setting jumpers and connecting peripherals, switches and indicators. Be sure to read all the safety precautions before you begin the installation procedures.

- Jumpers and Connectors
- CPU Installation and Upgrading
- COM Port Interface
- VGA Interface
- Watchdog Timer Configuration

5.1 Jumpers and Connectors

5.1.1 Setting jumpers

You can configure your panel PC to match the needs of your application by setting jumpers. A jumper is the simplest kind of electrical switch. It consists of two metal pins and a small metal clip (often protected by a plastic cover) that slides over the pins to connect them. To “close” a jumper, you connect the pins with the clip. To “open” a jumper you remove the clip. Sometimes a jumper will have three pins, labeled 1, 2, and 3. In this case, you would connect either pins 1 and 2 or pins 2 and 3.

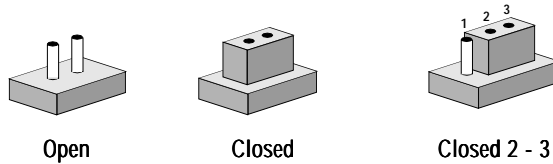

The jumper settings are schematically depicted in this manual as follows:

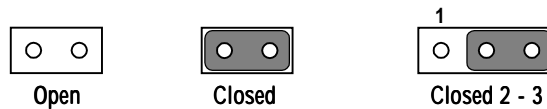

A pair of needle-nose pliers may be helpful when working with jumpers.

If you have any doubts about the best hardware configuration for your application, contact your local distributor or sales representative before you make any changes.

5.1.2 Jumpers

The motherboard of the panel PC has a number of jumpers that allow you to configure your system to suit your applications. The table below lists the function of each of the board's jumpers.

Table 5-1: Jumpers and their functions

Label	Function
JP1	COM3 RI pin setting (Reserved)
JP2	COM4 RI pin setting (Reserved)
JP3	COM2 RS-232/422/485 setting
JP4	COM2 RS-232/422/485 setting
JP5	COM2 RS-232/422/485 setting
JP6	Panel V _{CC} setting
JP7	ENVEE pin setting
JP8	PCI bus clock setting
JP9	Panel type select
JP10	Cyrix linear mode enable
JP11	System/PCI clock setting
JP12	CMOS clear for external RTC
JP13	CPU V _{CORE} voltage setting
JP14	CPU frequency ratio setting
JP15	Watchdog timer action
JP16	Reset
JP17	CMOS clear for 5582 internal RTC (Reserved)
JP18	AT/ATX power select (Reserved)

5.1.3 Locating jumpers

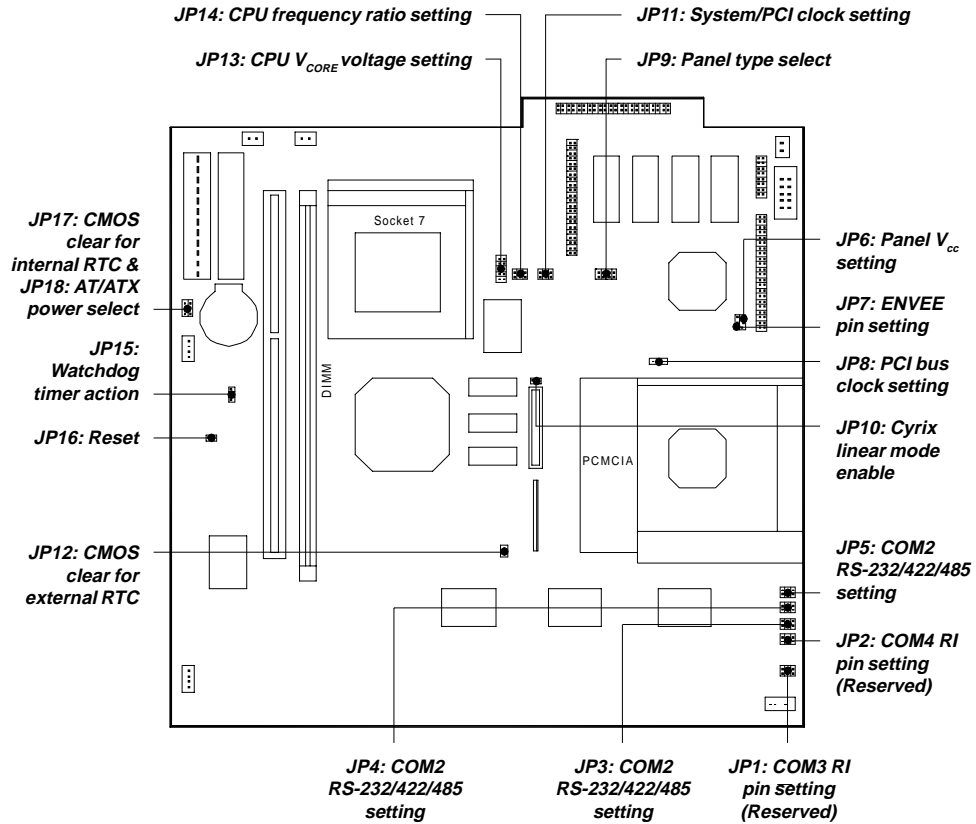

Figure 5-1: Locating jumpers on the PPC-120/140 motherboard

5.1.4 Connectors

On-board connectors link the panel PC to external devices such as hard disk drives or floppy drives. The table below lists the function of each of the board's connectors.

Table 5-2: Panel PC connectors

Label	Function
J1	IR connector
J2	Flat panel display connector
J3	Flat panel display connector
J4	Internal COM4 connector
J5	Touchscreen power connector
J6	Sandisk SSD connector
J7	EIDE hard disk driver connector
J8	Floppy driver connector
J9	CD-ROM connector
J10	CPU fan power connector
J11	PCI/ISA bus expansion connector
J12	Fan power connector
J13	AT power connector
J14	ATX power connector (Reserved)
J15	Internal speaker connector
J16	Inverter power connector

5.1.5 Locating connectors

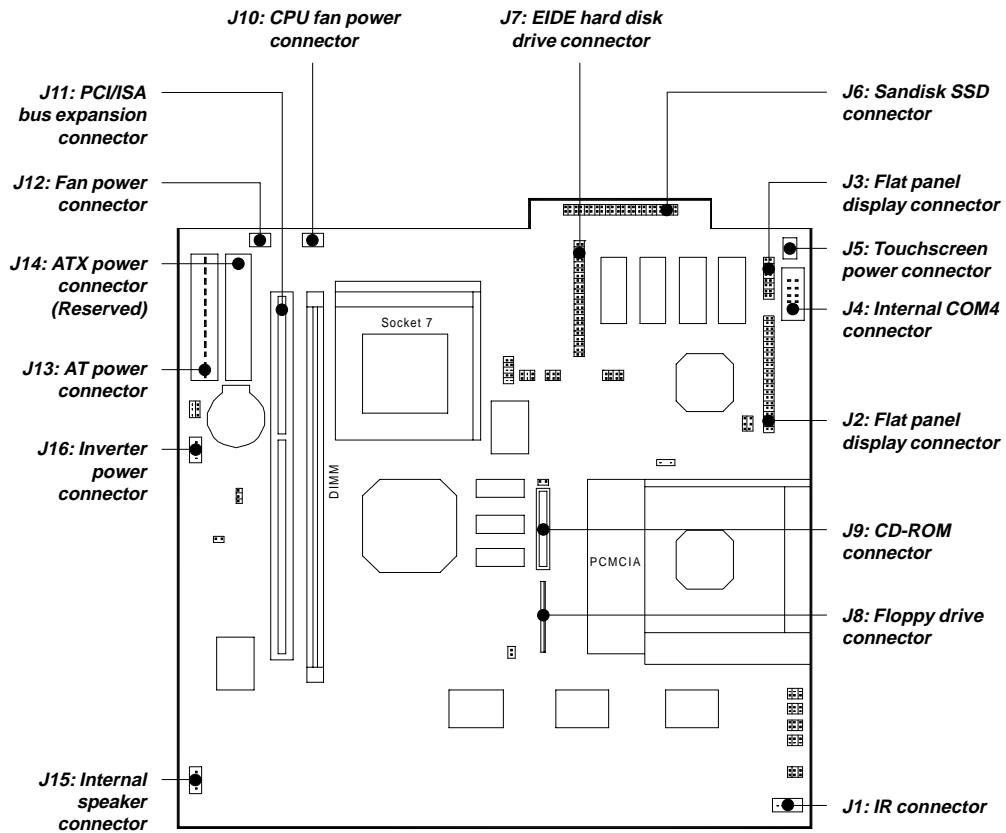

Figure 5-2: Locating connectors on the PPC-120/140 motherboard

5.2 CPU Installation and Upgrading

You can upgrade to a higher power Pentium®, AMD or Cyrix processor at any time. Simply remove the old CPU, install the new one, and set the jumpers for the new CPU type and speed.

5.2.1 System clock setting (JP11, JP8)

JP11 and JP8 are used to set the CPU and PCI bus speeds respectively, to optimize the system's performance. The system chipset will sense the JP8 setting to get the bus frequency, then adjust its internal timing. JP11 is used to set the CPU and PCI clock. Refer to the CPU speed reference table for instructions on adjusting the internal clocks according to the base CPU speed.

Table 5-3: System/PCI clock setting (JP11)

PCI clock	CPU clock	
25 MHz	50 MHz	
30 MHz	60 MHz	
33 MHz	66 MHz	
28 MHz	55 MHz	
38 MHz	75 MHz	
42 MHz	83 MHz	
(Reserved)		

Table 5-4: PCI bus clock setting (JP8)

PCI clock

* CPUCLK/2

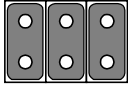
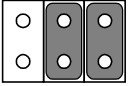
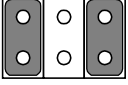
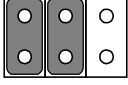
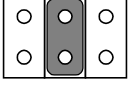
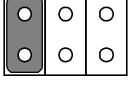
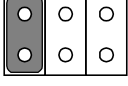
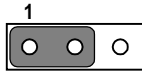

32MHz



* default setting

5.2.2 CPU core voltage setting (JP13)

JP13 must be set to match the CPU type. The following chart shows the proper jumper settings for their respective $V_{CC(CORE)}$. (The $V_{CC(I/O)}$ for the CPU is fixed at 3.3 V.)

Table 5-5: CPU voltage setting (JP13)

$V_{CC(CORE)}$ 1.30 V	$V_{CC(CORE)}$ 1.35 V	$V_{CC(CORE)}$ 1.40 V	$V_{CC(CORE)}$ 1.45 V
$V_{CC(CORE)}$ 1.50 V	$V_{CC(CORE)}$ 1.55 V	$V_{CC(CORE)}$ 1.60 V	$V_{CC(CORE)}$ 1.65 V
$V_{CC(CORE)}$ 1.70 V	$V_{CC(CORE)}$ 1.75 V	$V_{CC(CORE)}$ 1.80 V	$V_{CC(CORE)}$ 1.85 V
$V_{CC(CORE)}$ 1.90 V	$V_{CC(CORE)}$ 1.95 V	$V_{CC(CORE)}$ 2.00 V	$V_{CC(CORE)}$ 2.05 V

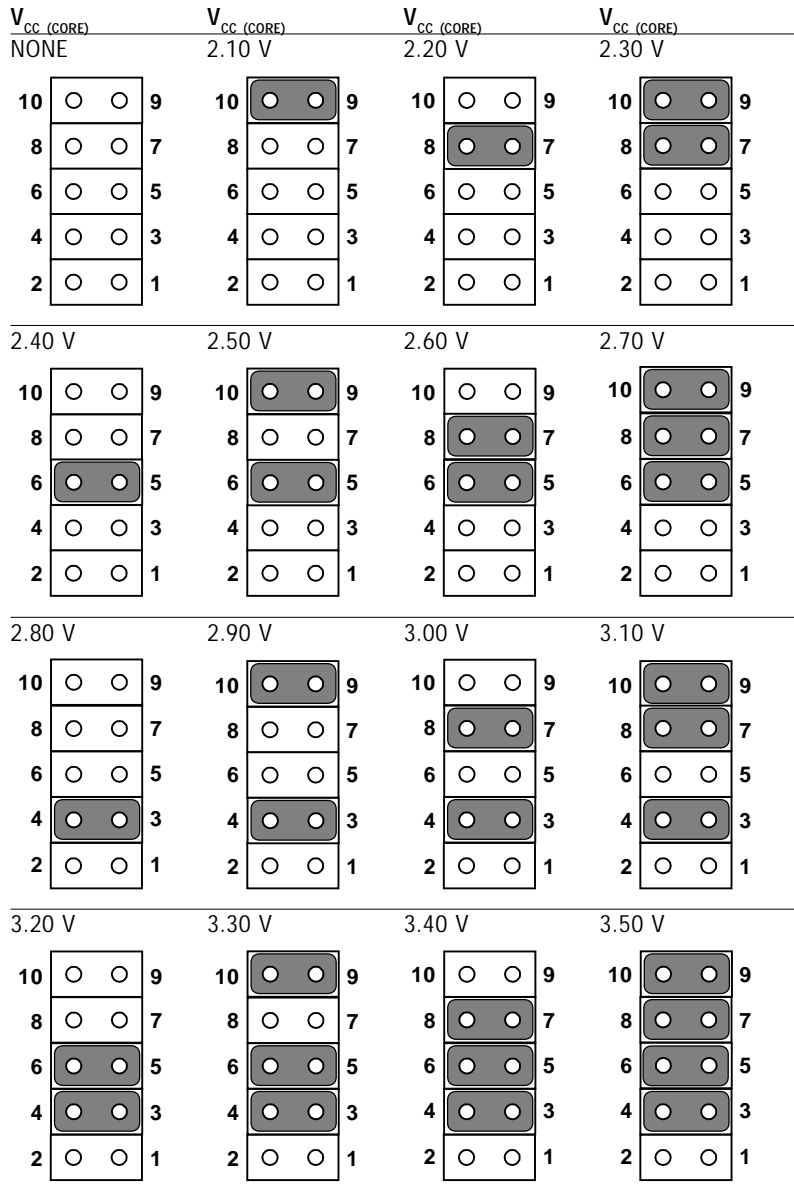

5.2.3 CPU frequency ratio setting (JP14)

Table 5-6: CPU frequency ratio (for Intel) (JP14)

P55C	P54C	
3.5x	1.5x	
2x	2x	
3x	3x	
2.5x	2.5x	

Table 5-7: CPU frequency ratio (for AMD K6) (JP14)



5.2.4 CMOS clear for external RTC (JP12)

Warning: To avoid damaging the computer, always turn off the power supply before setting "Clear CMOS". Set the jumper back to "3.0 V Battery On" before turning on the power supply.

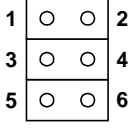
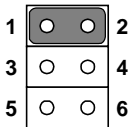
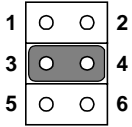
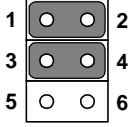
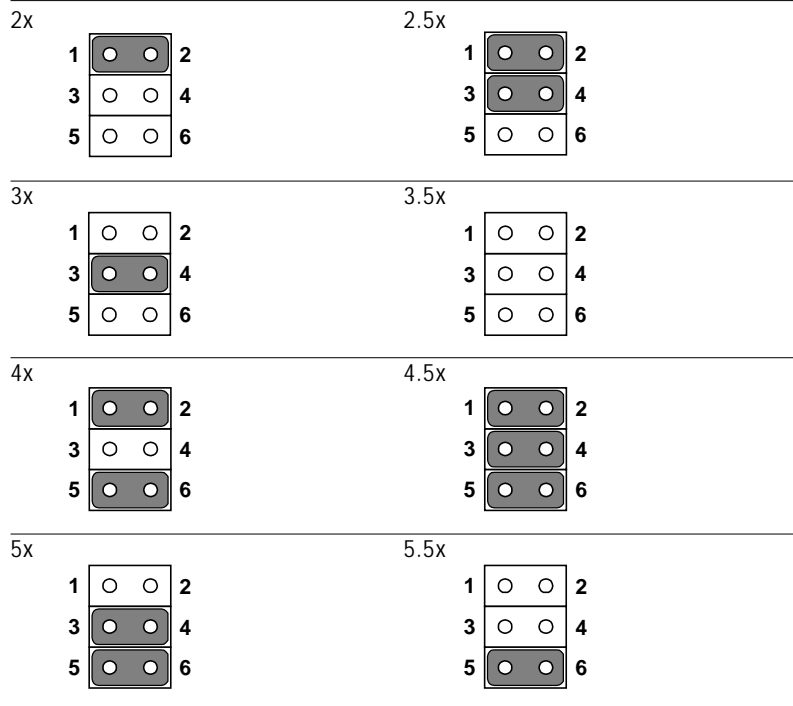
Table 5-8: Clear CMOS/External RTC (JP12)

* normal operation

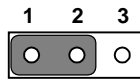

Clear CMOS

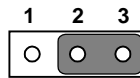

* default setting

5.2.5 Cyrix linear mode enable (JP10)

The panel PC supports Cyrix M1 CPU with its linear access mode on L2 cache. This mode is set through JP10.

Table 5-9: Cyrix linear mode enable (JP10)

* open = disable (normal operation)



closed = Cyrix linear mode



* default setting

5.2.6 Reset system (JP16)

Table 5-10: Reset system (JP16)

* open = normal operation



closed = reset system



* default setting

5.3 COM-port Interface

The panel PC provides four serial ports (COM1, 3, 4: RS-232; COM2: RS-232/422/485) in one COM port connector.

5.3.1 COM2 RS-232/422/485 setting (JP3, JP4, JP5)

COM2 can be configured to operate in RS-232, RS-422, or RS-485 mode. This is done via JP6 and JP5.

Table 5-11: COM2 RS-232/422/485 setting (JP3, JP4)

* RS-232		RS-422/485	
JP4		JP4	
JP3		JP3	

* default setting

Table 5-12: COM2 RS-232/422/485 setting (JP5)

* RS-232	RS-422	RS-485
<p>2 4 6</p> <p>1 3 5</p>	<p>2 4 6</p> <p>1 3 5</p>	<p>2 4 6</p> <p>1 3 5</p>

* default setting

The IRQ and the address ranges for COM1, 2, 3, and 4 are fixed. However, if you wish to disable the port or change these parameters later you can do this in the system BIOS setup. The table overleaf shows the default settings for the panel PC's serial ports.

COM1 and COM2 are one set. You can exchange the address range and interrupt IRQ of COM1 for the address range and interrupt IRQ of COM2. After exchanging, COM1's address range is 2F8 ~ 2FF and its request IRQ is IRQ3; and COM2's address range is 3F8 ~ 3FF and its interrupt IRQ is IRQ4.

COM3 and COM4 are another set. Their selectable function is the same as the COM1/COM2 set.

Table 5-13: PPC-120/140 serial port default settings

Port	Address Range	Interrupt
COM1	3F8 - 3FF	IRQ4
COM2	2F8 - 2FF	IRQ3
COM3	3E8 - 3EF	IRQ10
COM4	2E8 - 2EF	IRQ5

5.3.2 COM3/COM4/RI pin setting (JP2, JP1) (Reserved)

Table 5-14: COM4/RI pin setting (JP2)

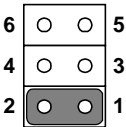
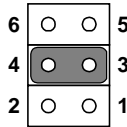
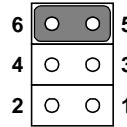
+5 V output	+12 V output	* RI output
		

* default setting

Table 5-15: COM3/RI pin setting (JP1)

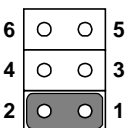
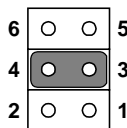
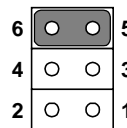
+5 V output	+12 V output	* RI output
		

* default setting

5.4 VGA Interface

The panel PC's's PCI SVGA interface can drive conventional CRT displays and is capable of driving a wide range of flat panel displays, including electroluminescent (EL), gas plasma, passive LCD and active LCD displays. The board has two connectors to support these displays simultaneously; one for standard CRT VGA monitors and one for flat panel displays.

CRT display port information can be found in Section 3.9 - VGA Port.

The pin assignments for the flat panel display connector, backlight connector and other related connectors are described in the appendices.

5.4.1 LCD panel power setting (JP6)

The panel PC's's PCI SVGA interface supports 5 V and 3.3 V LCD displays. By changing the setting of JP6, you can select the panel video signal level to be 5 V or 3.3 V.

Table 5-16: Panel V_{cc} setting (JP6)

* 5 V

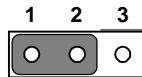

3.3 V

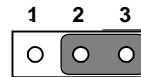

* default setting

Configuration of the VGA interface is done exclusively via the software utility. You do not have to set any jumpers. Refer to Chapter 8 for software setup details.

5.4.2 Panel type select (JP9)

Table 5-17: Panel type select (JP9)

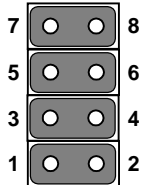
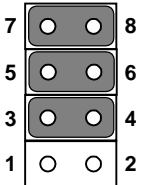
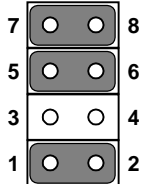
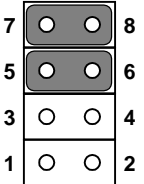
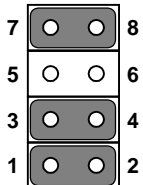
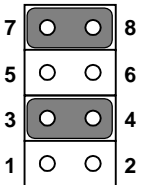
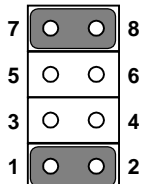
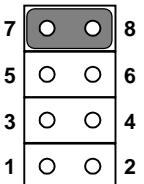
Maximum Resolution	Display Type	Maximum Resolution	Display Type
1. 1024 x 768	DSTN color	2. 1280 x 1024	TFT color
			
3. 640 x 480	DSTN color	4. 800 x 600	DSTN color
			
5. 640 x 480	SHARP TFT color	6. 640 x 480	18-bit TFT color
			
7. 1024 x 768	TFT color	8. 800 x 600	TFT color
			

Maximum Resolution	Display Type	Maximum Resolution	Display Type
9. 800 x 600	TFT color (44 K BIOS only)	10. 800 x 600	TFT color
11. 800 x 600	DSTN color (44 K BIOS only)	12. 800 x 600	DSTN color
13. 1024 x 768	TFT color (44 K BIOS only)	14. 1280 x 1024	DSTN color (44 K BIOS only)
15. 1024 x 600	TFT color (48-K BIOS only)	16. 1024 x 600	TFT color

5.5 Watchdog Timer Configuration

An on-board watchdog timer reduces the chance of disruptions which EMP (electromagnetic pulse) interference can cause. This is an invaluable protective device for standalone or unmanned applications. Setup involves one jumper and running the control software. (Refer to Appendix B.)

5.5.1 Watchdog activity selection (JP15)

When the watchdog timer activates (i.e. CPU processing has come to a halt), it can reset the system or generate an interrupt on IRQ11. This can be set via jumper JP15 as shown below:

Table 5-18: Watchdog activity selection (JP15)

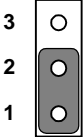
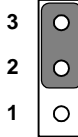
* System reset	IRQ11
	

* default setting

CHAPTER 6

PCI Bus Ethernet Interface

This chapter provides information on Ethernet configuration.

- Introduction
- Installation of Ethernet Driver
 - Installation for MS-DOS & WINDOWS 3.1
 - Installation for WINDOWS 95
 - Installation for WINDOWS NT
- Further Information

6.1 Introduction

The PPC-120/140 is equipped with a high performance 32-bit Ethernet chipset which is fully compliant with IEEE 802.3 100 Mbps CSMA/CD standards. It is supported by major network operating systems. It is also both 100Base-T and 10Base-T compatible. The medium type can be configured via the RSET8139.exe program included on the utility disk.

The Ethernet port provides a standard RJ-45 jack. The network boot feature can be utilized by incorporating the boot ROM image files for the appropriate network operating system. The boot ROM BIOS files are combined with system BIOS, which can be enabled/disabled in the BIOS setup.

6.2 Installation of Ethernet Driver

Before installing the Ethernet driver, note the procedures below. You must know which operating system you are using in your PPC-120/140, and then refer to the corresponding installation flow chart. Then just follow the steps described in the flow chart. You will quickly and successfully complete the installation, even if you are not familiar with instructions for MS-DOS or WINDOWS.

Note 1: The windows illustrations in this chapter are examples only. You must follow the flow chart instructions and pay attention to the instructions which then appear on your screen.

Note 2: The CD-ROM drive is designated as "D" throughout this chapter.

6.2.1 Installation for MS-DOS & WINDOWS 3.1

If you want to set up your Ethernet connection under the MS-DOS or Windows 3.1 environment, you should first check your server system model. For example, MS-NT, IBM-LAN server, and so on.

Then choose the correct driver to install in your panel PC.

The installation procedures for various servers can be found in the directory path "LAN/TXT/*" of the drivers and utilities CD-ROM, where * is your server model.

6.2.2 Installation for WINDOWS 95

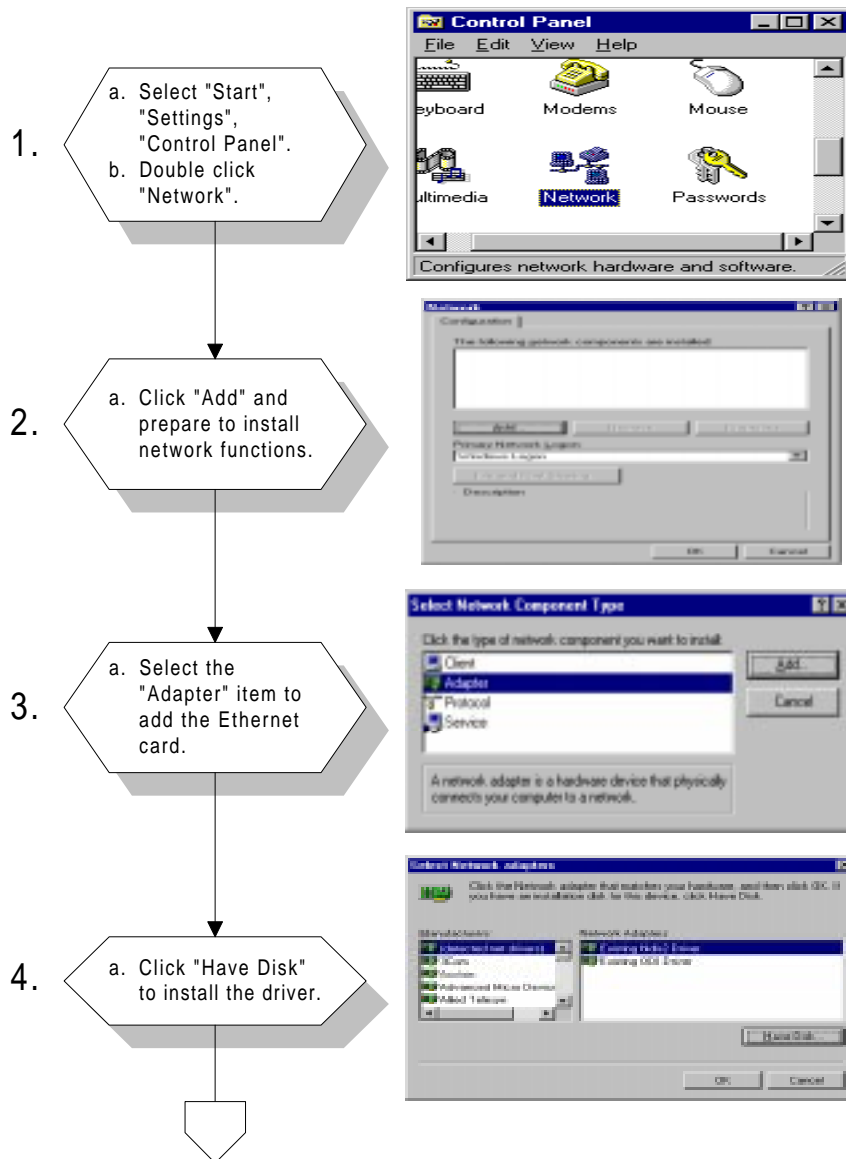

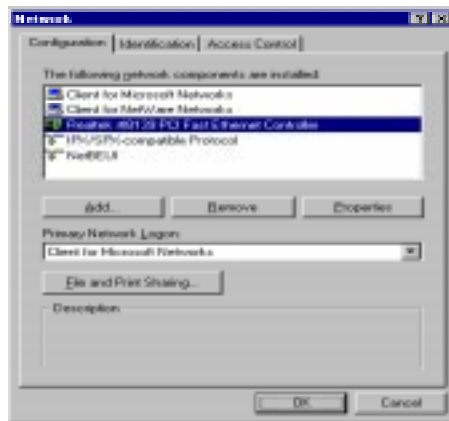
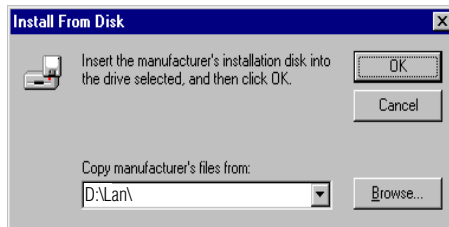
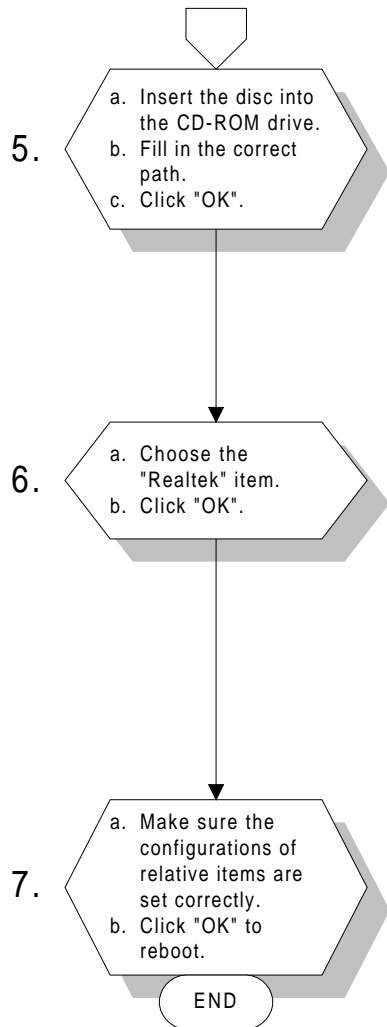

6.2.3 Installation for WINDOWS NT

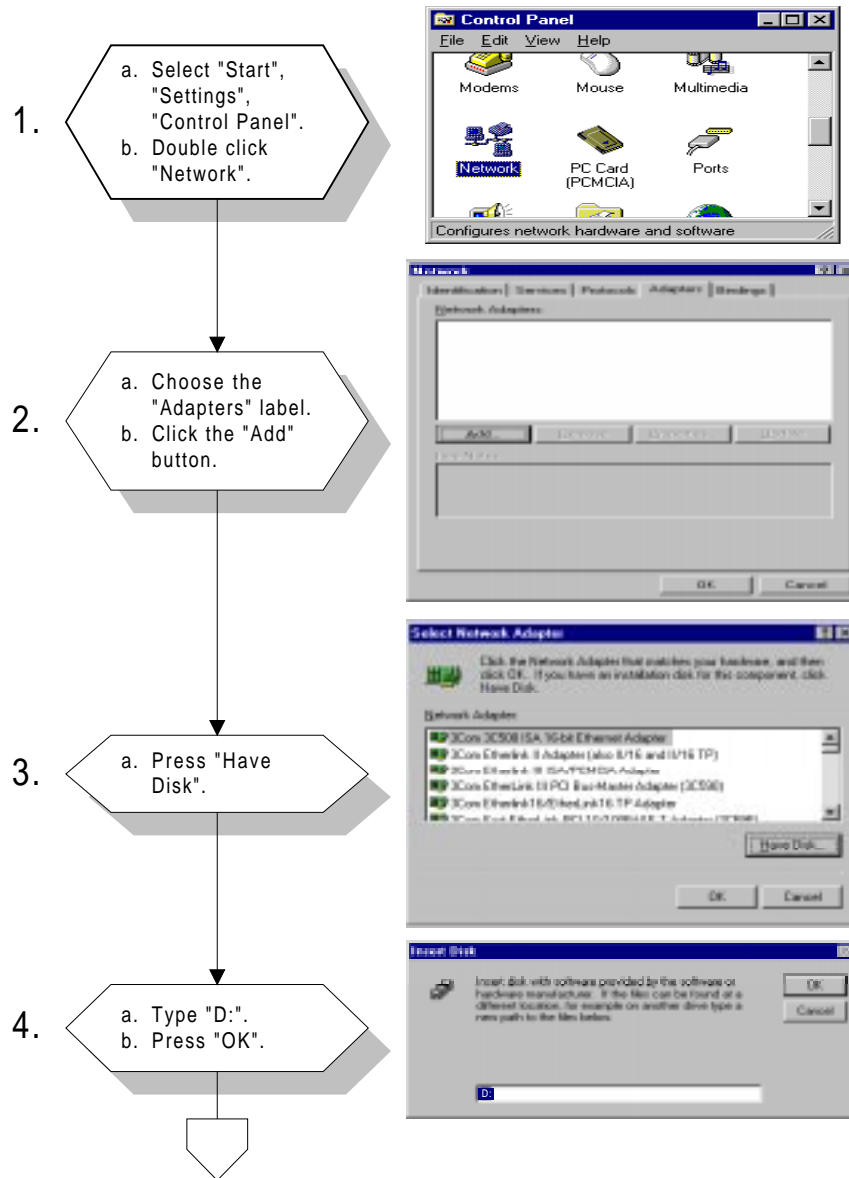

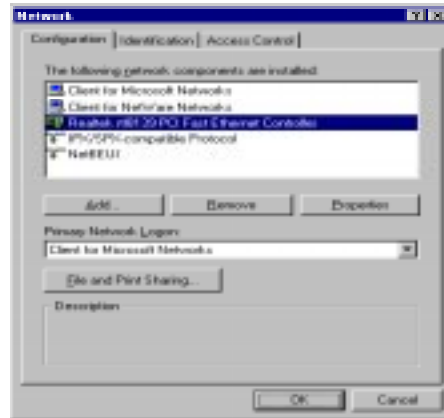
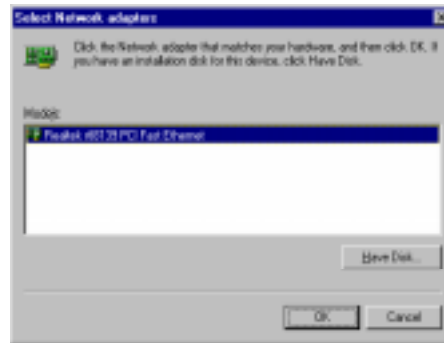
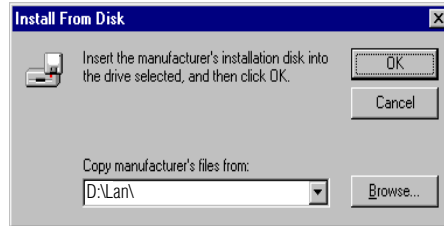
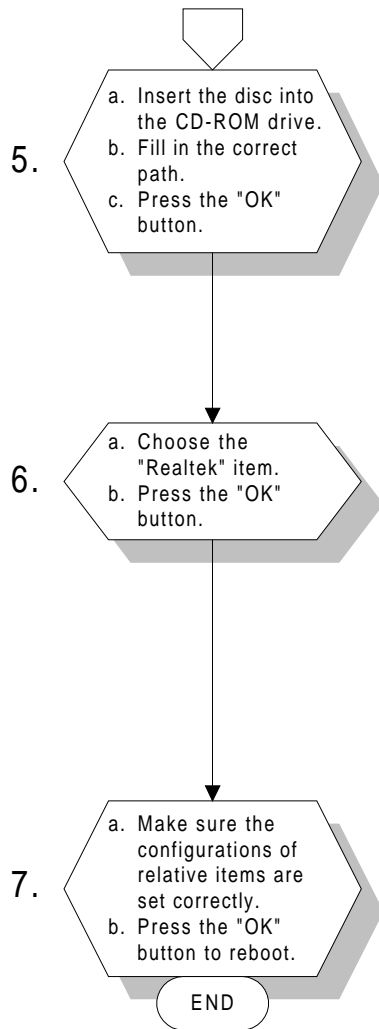

6.3 Further Information

Realtek web: www.realtek.com

Advantech web: www.advantech-usa.com or www.advantech.com.tw

CHAPTER 7

PCI SVGA Setup

- Introduction
- Installation of SVGA Driver
 - Installation for WINDOWS 3.1
 - Installation for WINDOWS 95
 - Installation for WINDOWS NT
 - Installation for OS/2
- Further Information

7.1 Introduction

The PPC-120/140 has an on-board PCI flat panel/VGA interface. The specifications and features are described as follows:

Chipset

The PPC-120/140 uses a C&T 65555 chipset for its PCI/SVGA controller. It supports many popular LCD, EL, and gas plasma flat panel displays and conventional analog CRT monitors. The 65555 VGA BIOS supports monochrome LCD, EL, color TFT and STN LCD flat panel displays. In addition, it also supports interlaced and non-interlaced analog monitors (color and monochrome VGA) in high-resolution modes while maintaining complete IBM VGA compatibility. Digital monitors (i.e. MDA, CGA, and EGA) are NOT supported. Multiple frequency (multisync) monitors are handled as if they were analog monitors.

Display memory

With on-board 2 MB display memory, the VGA controller can drive CRT displays or color panel displays with resolutions up to 1024 x 768 at 64 K colors. The display memory can be expanded to 4 MB for true-color resolution of 1024 x 768.

Display types

CRT and panel displays can be used simultaneously. The PPC-120/140 can be set in one of three configurations: on a CRT, on a flat panel display, or on both simultaneously. The system is initially set to simultaneous display mode. The CD-ROM disc includes three *.COM files in the subdirectory `Utility\vga\` which can be used to configure the display. In order to use these configuration programs, type the file name and path at the DOS prompt.

CT.COM: Enables CRT display only

FP.COM: Enables panel display only

SM.COM: Enables both displays simultaneously

7.2 Installation of SVGA driver

Complete the following steps to install the SVGA driver. Follow the procedures in the flow chart that apply to the operating system that you are using within your PPC-120/140.

Important: 1. The following windows illustrations are examples only. You must follow the flow chart instructions and pay attention to the instructions which then appear on your screen.

2. The resolution of the PPC-120 is 800 x 600 pixels (SVGA), whereas the resolution of the PPC-140 is 1024 x 768 pixels (XVGA).

Note 1: The CD-ROM drive is designated as "D" throughout this chapter.

Note 2: <Enter> means pressing the "Enter" key on the keyboard.

7.2.1 Installation for Windows 3.1

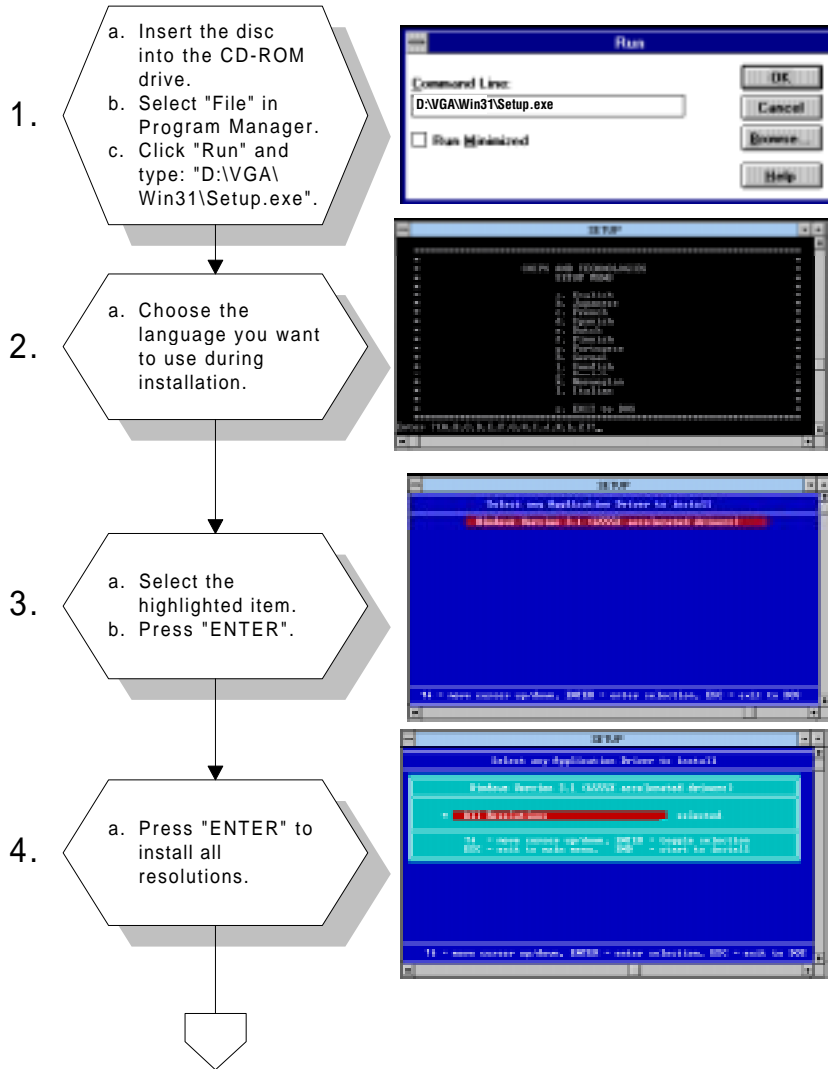

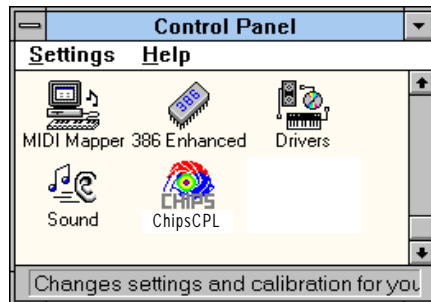
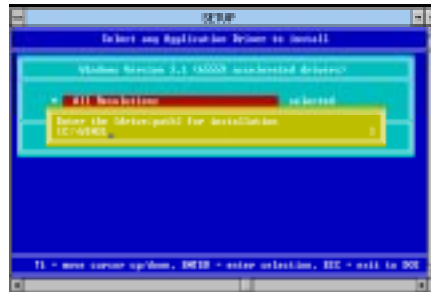
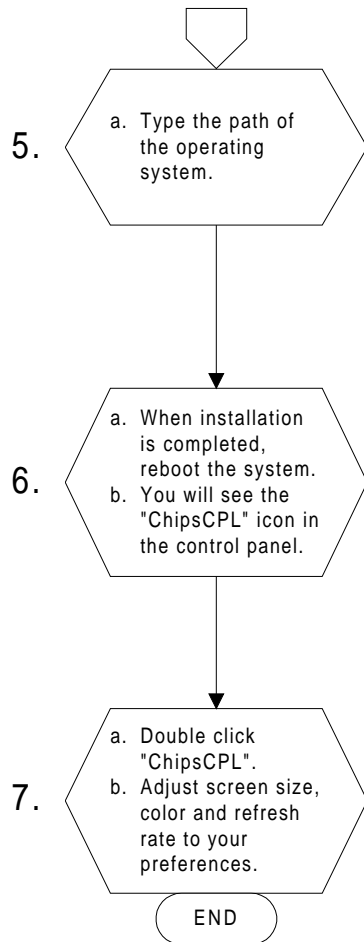

7.2.2 Installation for Windows 95

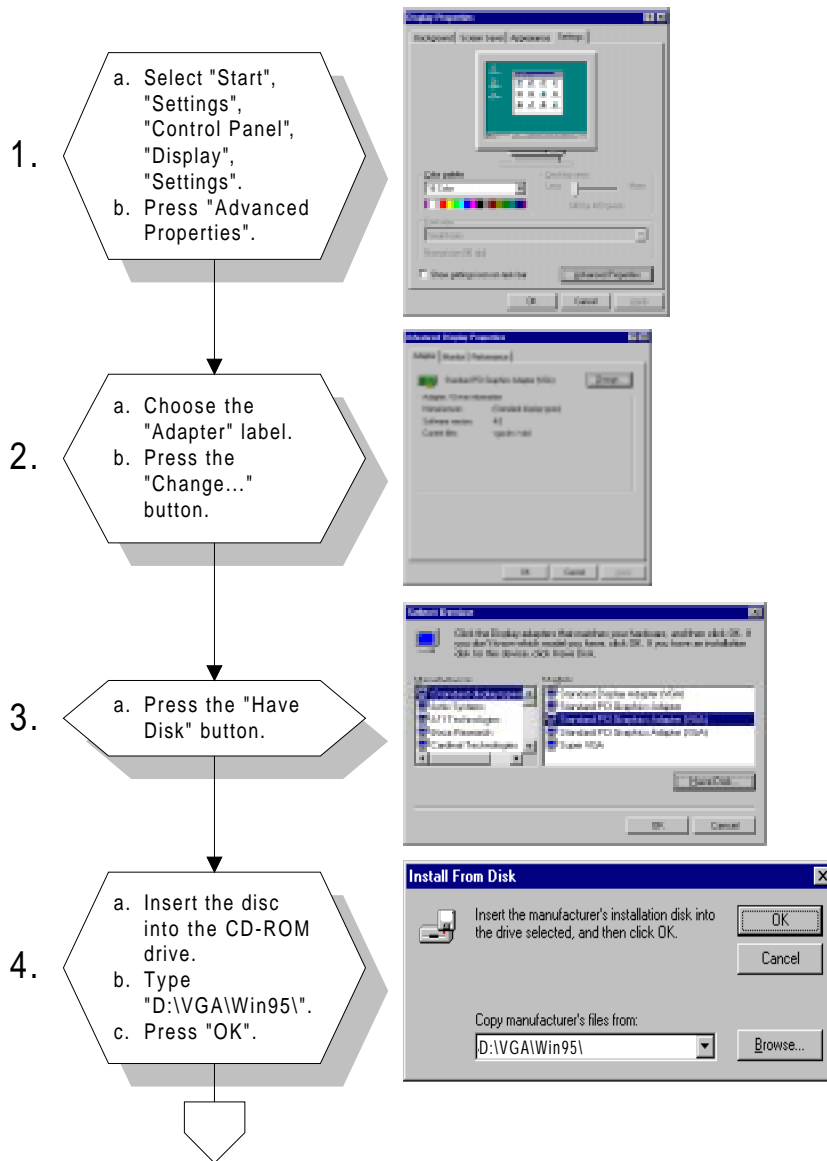

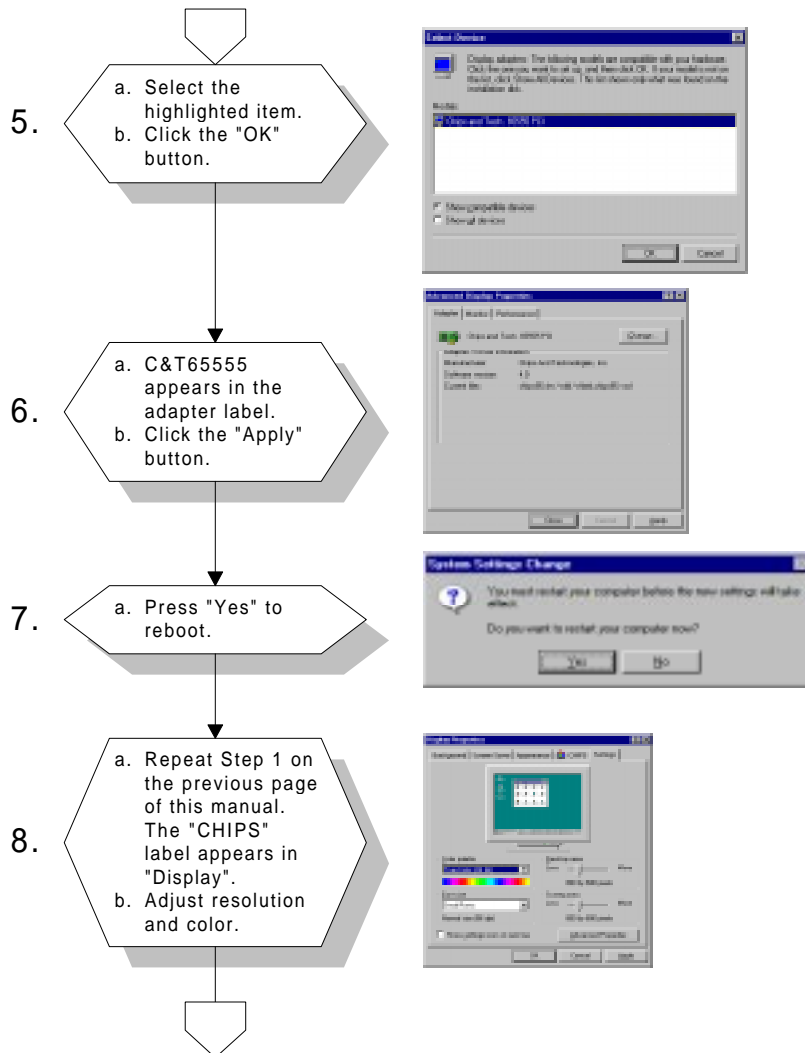

7.2.3 Installation for Windows NT

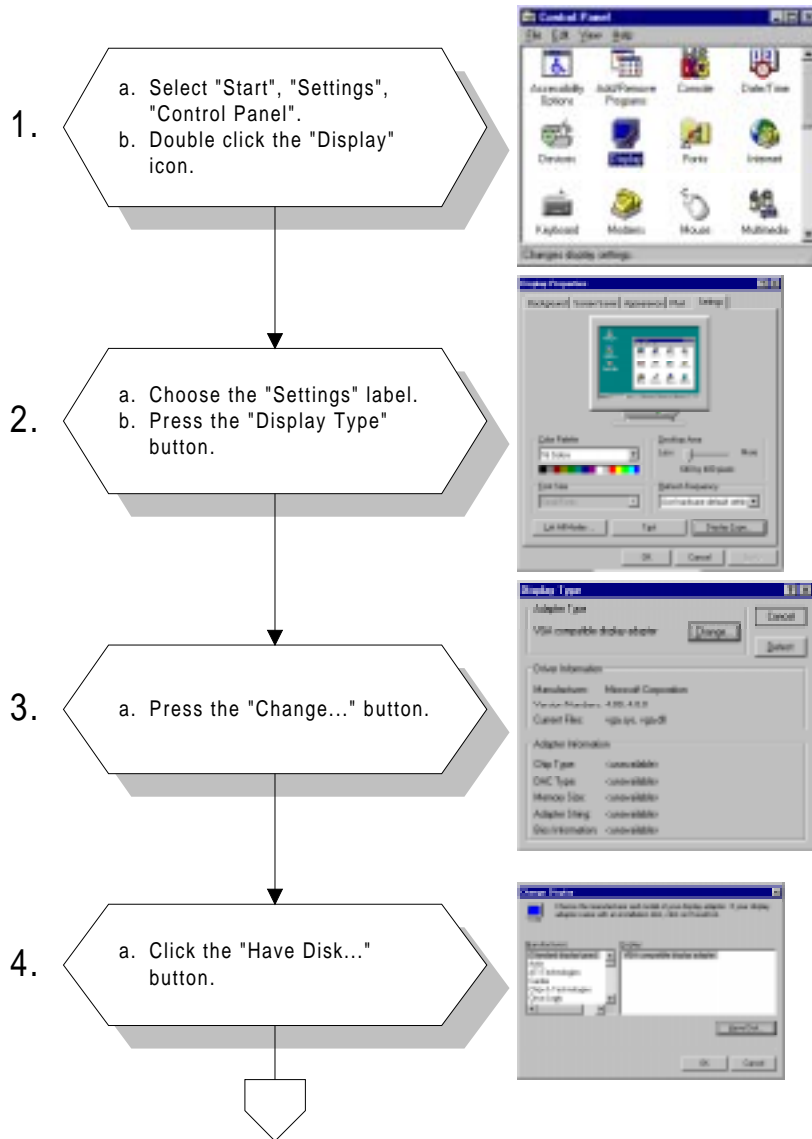

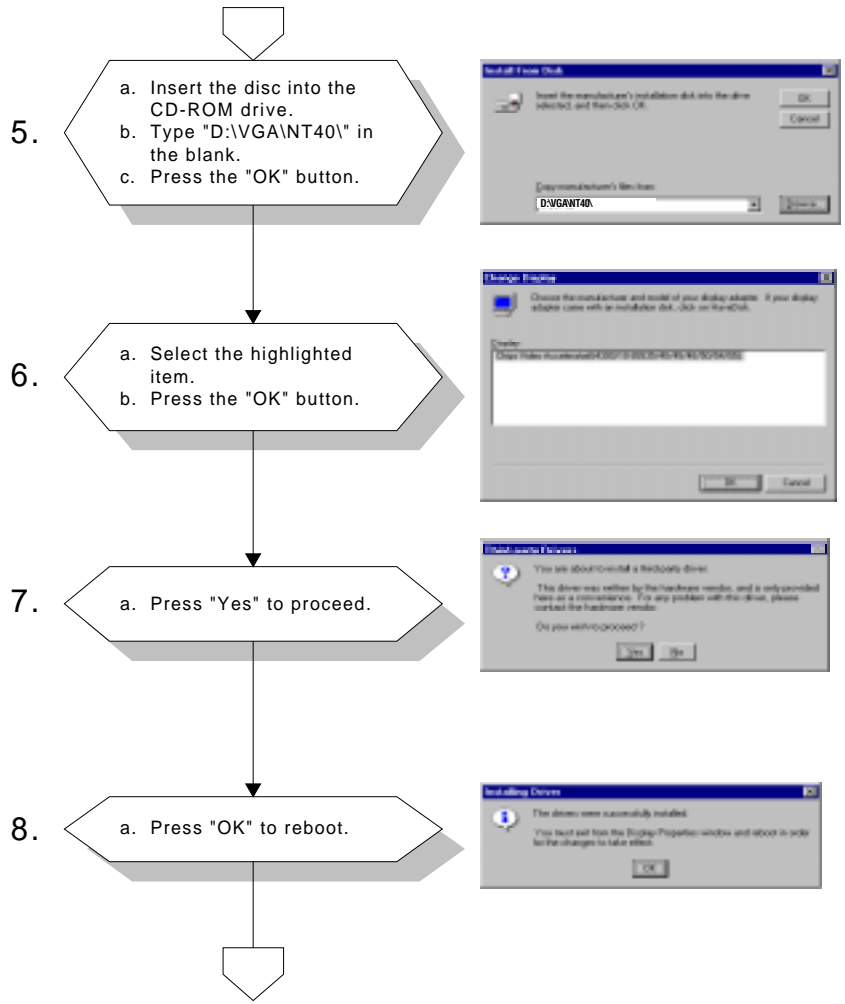

9.

- a. Repeat Step 1 in this manual, to select the "Settings" label.
- b. Adjust resolution and color.
- c. Click "Test" to see the result.
- d. Click "OK" to save the setting.

END

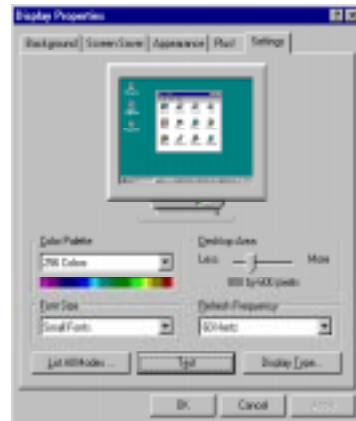

7.2.4 Installation for OS/2

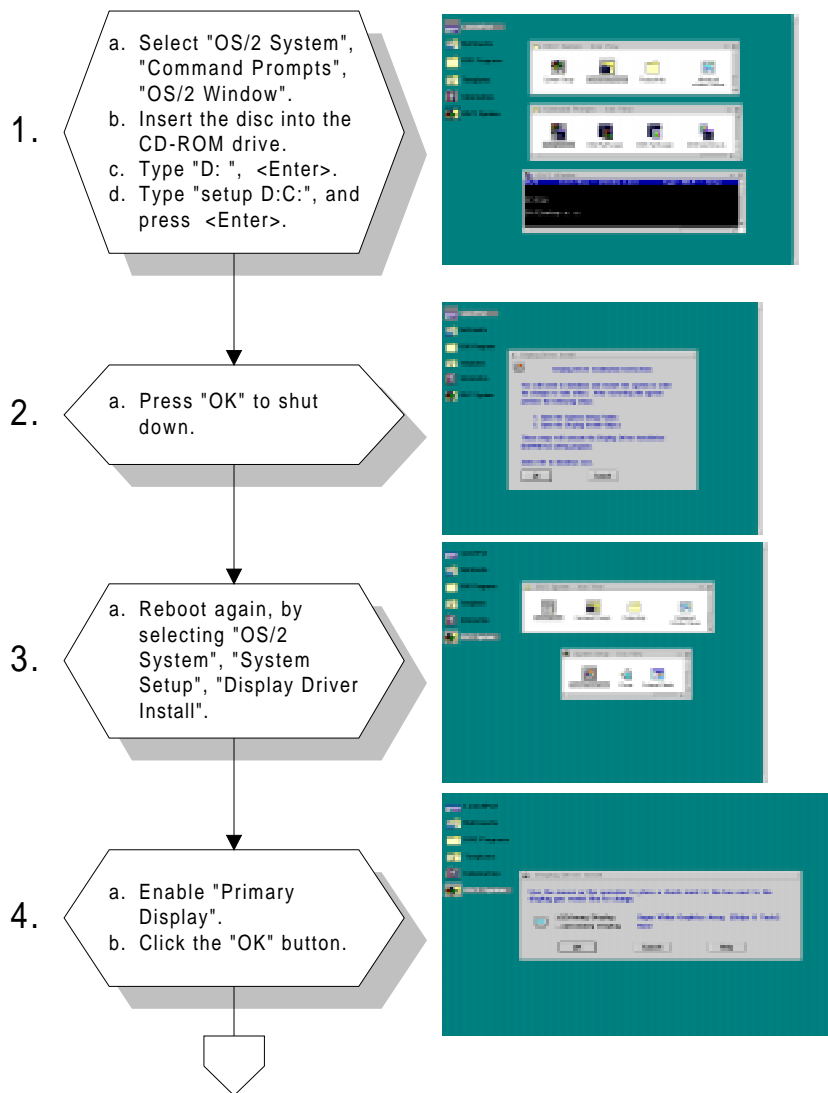

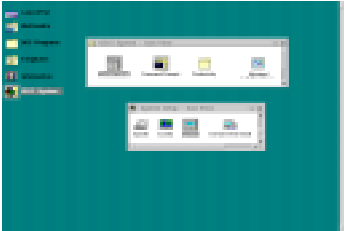
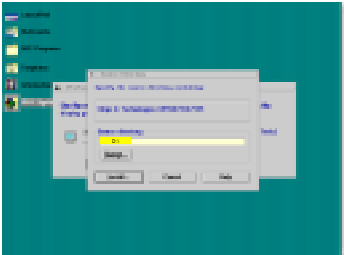
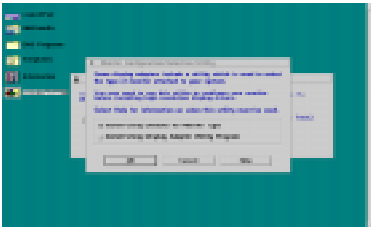
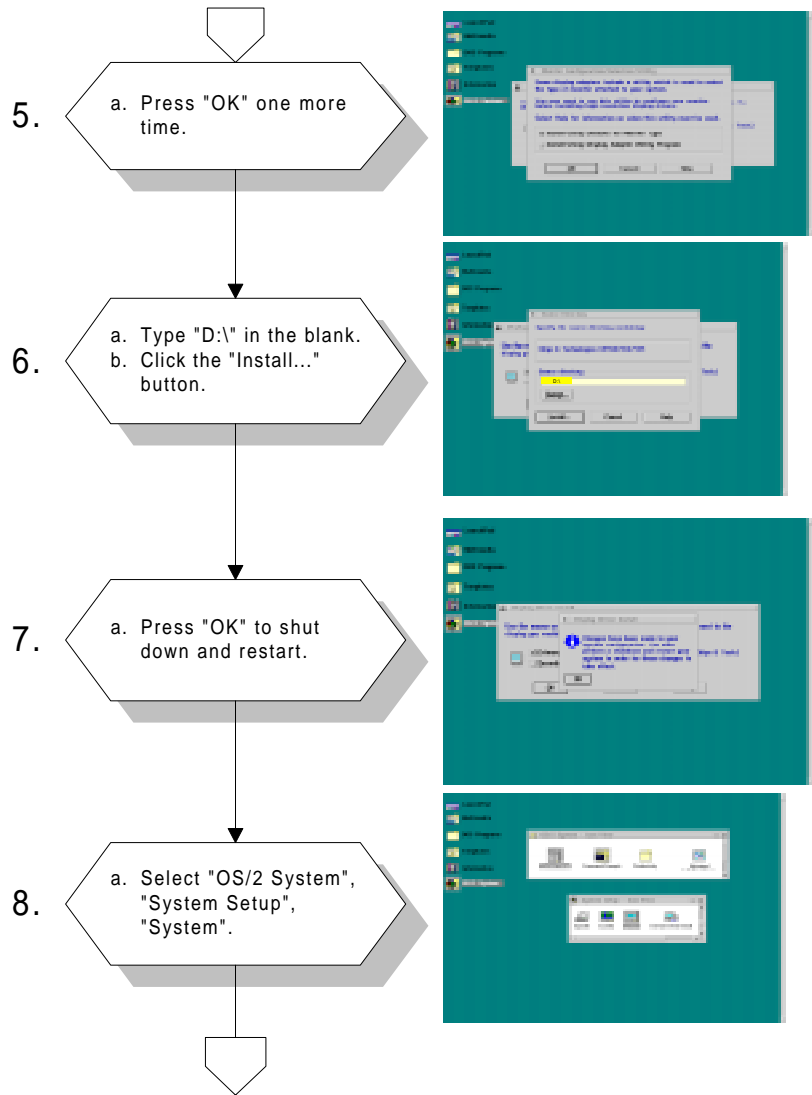

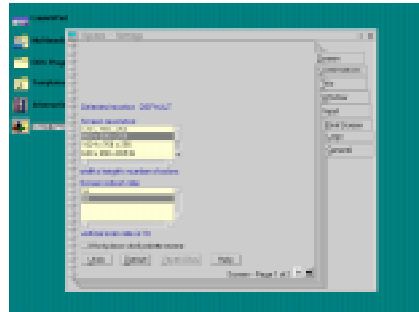
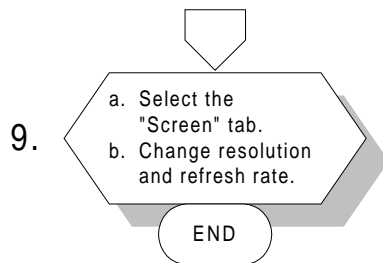

7.3 Further Information

For further information about the PCI/SVGA installation in your PPC-120/140, including driver updates, troubleshooting guides and FAQ lists, visit the following web resources:

C&T web site: www.chips.com

Advantech web sites: www.advantech.com

www.advantech.com.tw

Audio

- Introduction
- Installation of Audio Driver
 - Installation for MS-DOS & WINDOWS 3.1
 - Installation for WINDOWS 95
 - Installation for WINDOWS NT
 - Installation for OS/2

8.1 Introduction

The PPC-120/140 on-board audio interface provides high-quality stereo sound and FM music synthesis (ESFM) by using the ES1869 audio controller from ESS Technology, Inc. The audio interface can record, compress, and play back voice, sound, and music with a built-in mixer control. The PPC-120/140 on board audio interface also supports the Plug and Play (PnP) standard and provides PnP configuration for audio, FM, and MPU-104 logical devices. It is compatible with Sound Blaster, Sound Blaster Pro version 3.01, voice, and music functions. The ESFM synthesizer is register compatible with the OPL3 and has extended capabilities.

8.2 Installation of Audio Driver

Before installing the audio driver, please take note of the procedures detailed below. You must know which operating system you are using in your PPC-120/140, and then refer to the corresponding installation flow chart. Just follow the steps in the flow chart. You can quickly and successfully complete the installation, even though you are not familiar with instructions for MS-DOS or WINDOWS.

Note: *The CD-ROM drive is designated as "D" throughout this chapter.*

8.2.1 Installation of MS-DOS

The ES1869 audio controller supports PC games and applications for Sound Blaster and SoundBlaster Pro, with no need for a device driver in a DOS environment. The default settings for the audio controller in DOS are:

Address: 220H	IRQ: 9
DMA: 1	MPU-401: Disabled

8.2.2 Changing settings in DOS

The audio controller settings can be changed in the DOS environment by using the DOS SETUP utility located in the UTILITY subdirectory of the CD-ROM. To change the settings, simply type DOSSET at the DOS prompt. Follow the instructions on screen to choose the new settings for the ES1869 audio controller.

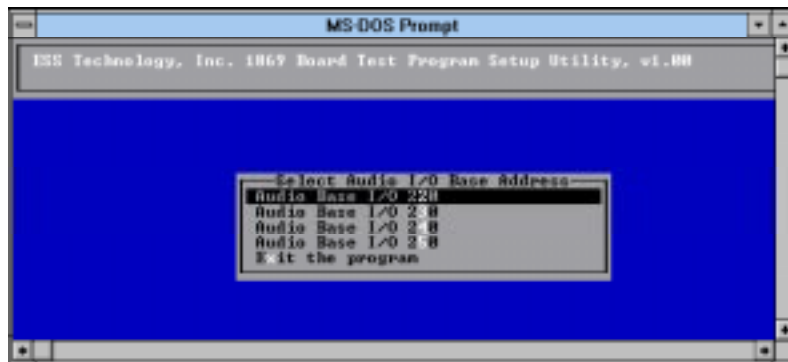

8.2.3 Controlling volume in DOS

The ES1869 audio controller provides software control of the settings for audio volumes. The VOLUME CONTROL utility located in the UTILITY\Audio\ subdirectory of the CD-ROM is used to control the volume settings in DOS. To control the volume settings, simply type "ESSVOL" at the DOS prompt with appropriate parameters. The script for ESSVOL is:

```
ESSVOL [/?] [/v:xx] [/l:xx] [/w:xx] [/m:xx]  
[/c:xx] [/s:xx] [/a:xx]
```

no option	Display all volume settings
/?	Display this message
/v	Change master volume
/l	Change line volume
/w	Change wave volume
/m	Change microphone volume
/c	Change CD volume
/s	Change synthesizer volume
/a	Change AuxB volume
/p	Change PC speaker volume
xx	Volume. Note: no xx means 0

The value range for volume is 0 ~ 15.

(The PC speaker volume range is 0 ~ 7.)

8.2.5 Installation for WINDOWS 95

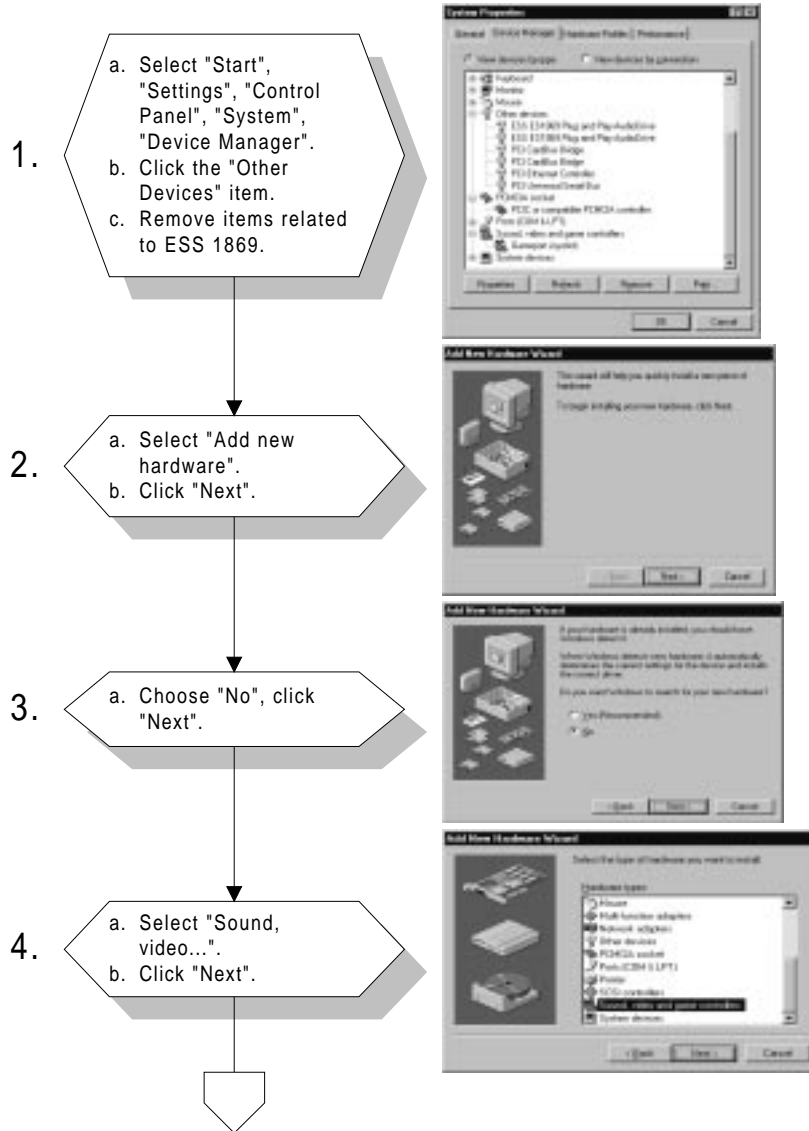

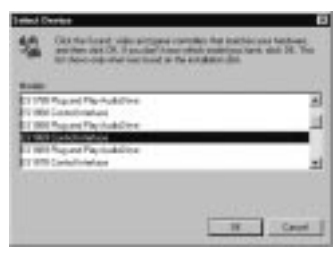
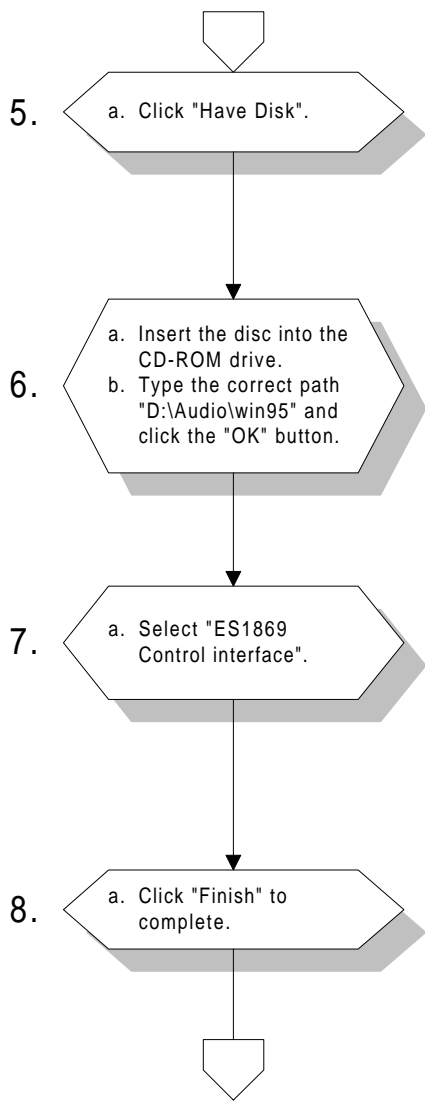

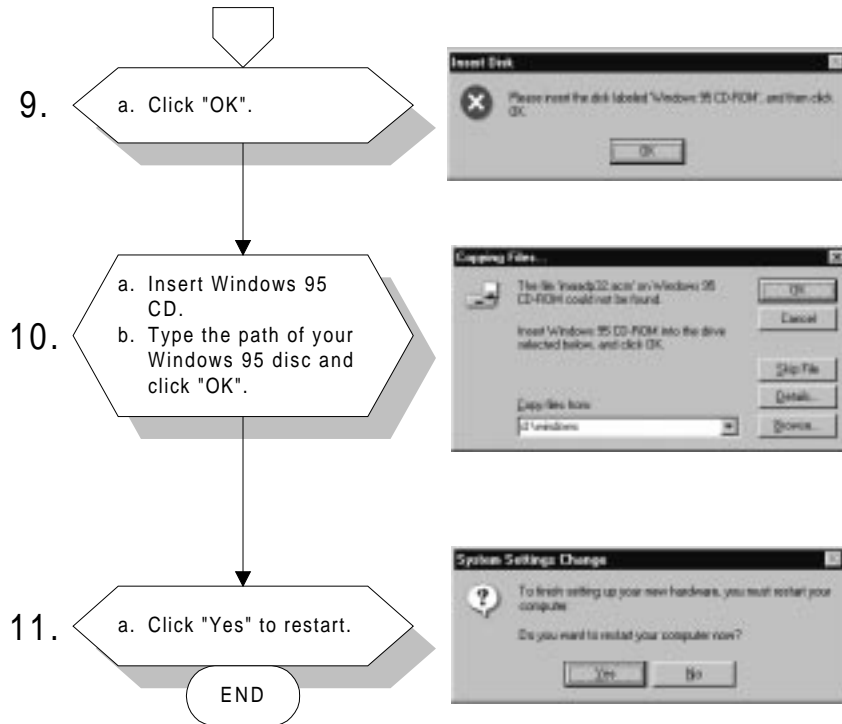

8.2.6 Installation for WINDOWS NT

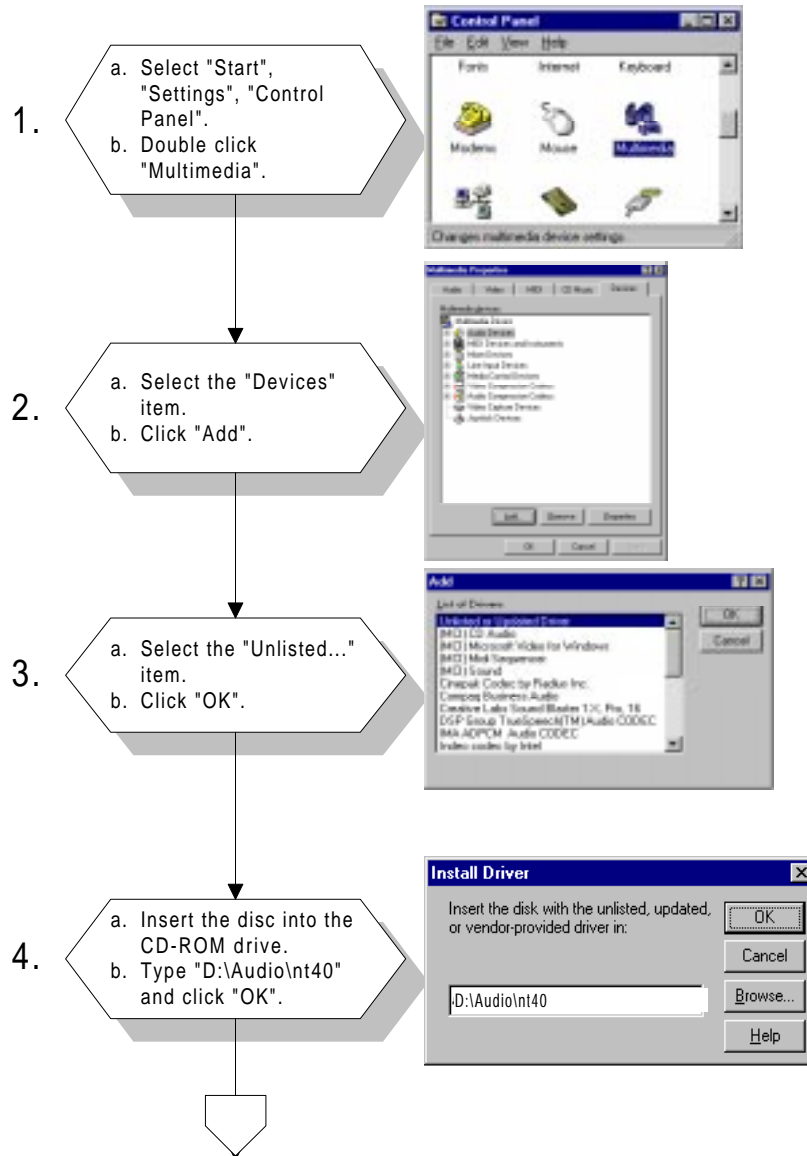

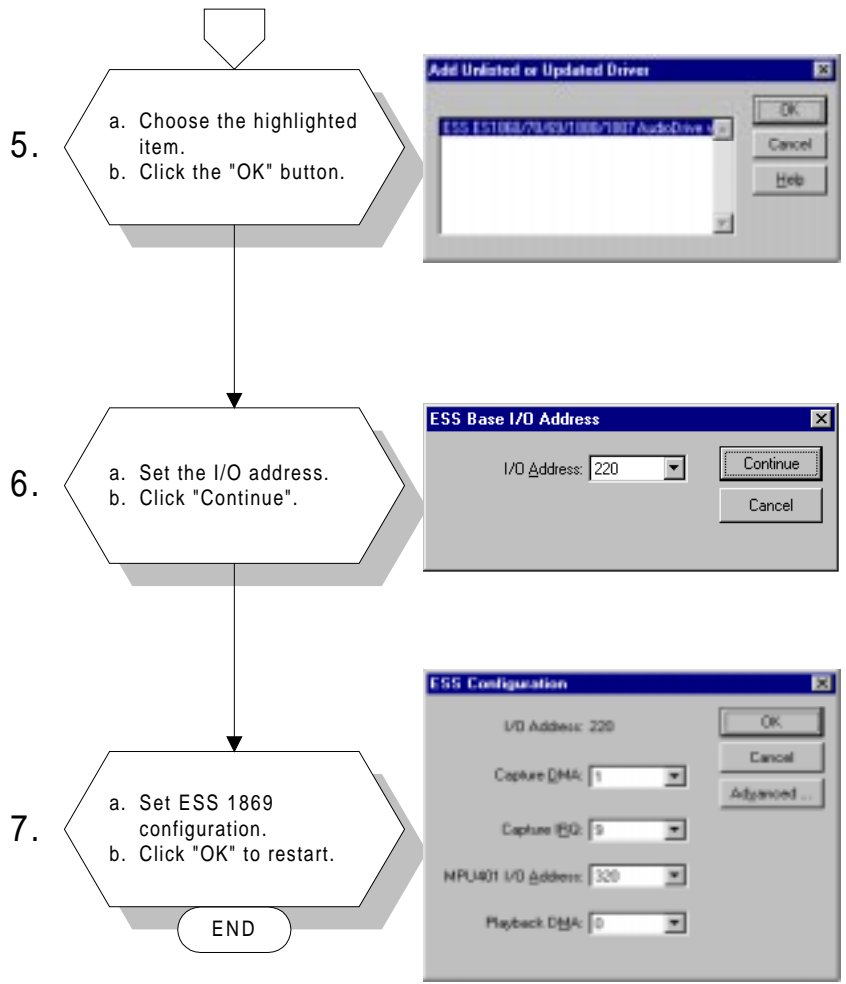

CHAPTER
9

Award BIOS Setup

This chapter describes how to set BIOS configuration data.

9.1 Award BIOS Setup

The PPC-120/140 comes with an Award BIOS chip that contains the ROM setup for your system. This chip serves as an interface between the processor and the rest of the mainboard's components. This chapter explains the information contained in the setup program and tells you how to modify the settings according to your system configuration. Some setup items will not be explained, because it is recommended that users do not change such items.

Note: Values for the various setup items that appear on your own screen (including default values) may not be the same as the values shown on the screen figures in this chapter. This is because the BIOS is revised and updated from time to time. If in doubt, check Advantech's web site for the latest BIOS versions and related information.

9.2 CMOS Setup Utility

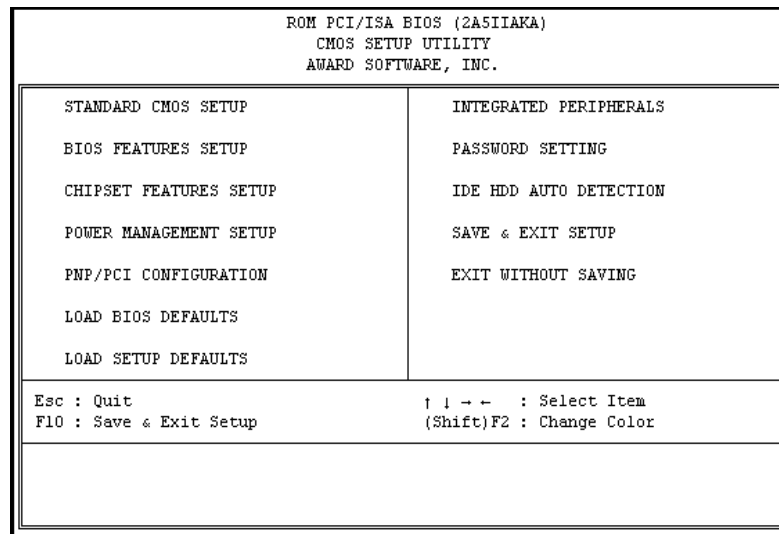

Figure 9-1: Setup program initial screen

A setup program, built into the system BIOS, is stored in the CMOS RAM that allows the configuration settings to be changed. This program is executed when the user changes the system configuration; when the user changes the system backup battery; or when the system detects a configuration error and asks the user to run the setup program. At power-on RAM testing, the message "Press DEL to enter Setup" appears. After pressing the "DEL" key, the CMOS setup utility screen will appear as shown in Fig. 9-1. Use the arrow keys to select and press "Enter" to run the selected program.

9.3 Standard CMOS Setup

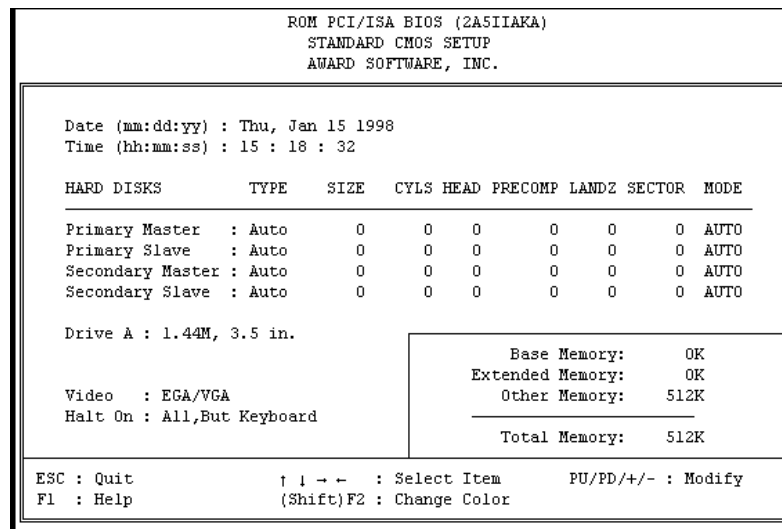

Figure 9-2: CMOS setup screen

The standard CMOS setup screen is shown above. System BIOS automatically detects memory size, so no changes are necessary. It has a few items requiring setting. Each item may have one or more optional settings. System BIOS allows you to change the system date and time, IDE hard disk, floppy disk drive types for drives A: and B:, boot-up video display mode, and POST error handling selection. Use the arrow keys to highlight the item and then use the "PgUp" or "PgDn" keys to select the value you want for each item.

9.3.1 Hard Disk Configurations

TYPE:

Select from 1 to 45 to fill the remaining fields with predefined values for disk drives. Select "User" to fill the remaining fields. Select "Auto" to detect the HDD type automatically.

SIZE:

Hard disk size. The unit is megabytes (MB).

CYLS:

The cylinder number of the hard disk.

HEAD:

The read/write head number of the hard disk.

PRECOMP:

The cylinder number at which the disk drive changes the write timing.

LANDZ:

The cylinder number where the disk drive heads (read/write) are seated when the disk drive is parked.

SECTOR:

The sector number of each track defined on the hard disk.

MODE:

Select "Auto" to detect the mode type automatically. If your hard disk supports the LBA mode, select "LBA" or "Large". However, if your hard disk supporting cylinder is more than 1024 MB and does not support the LBA function, you have to select "Large". If your hard disk supporting cylinder is below 1024 MB, select "Normal".

9.4 BIOS Features Setup

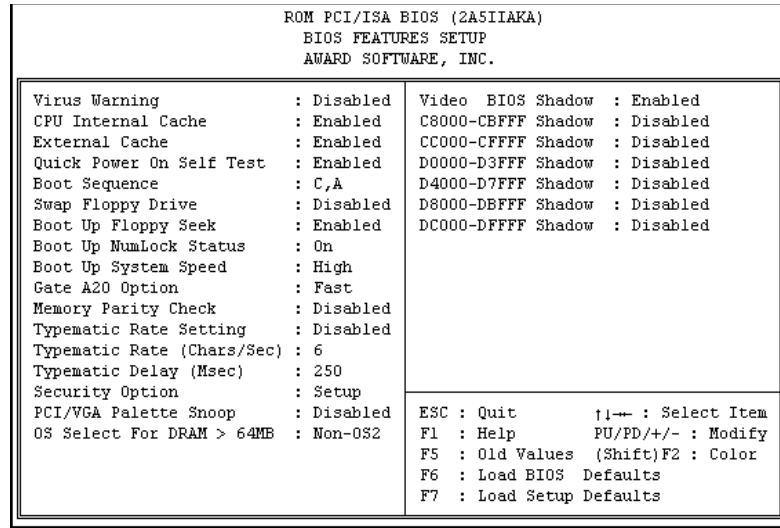

Figure 9-3: BIOS features setup screen

Moving around the BIOS Features and Chipset Features setup programs works the same way as moving around the Standard CMOS setup program. (Refer to the next section for Chipset Features setup.) The BIOS Features setup program is shown above. Users are not encouraged to run the BIOS and Chipset Features setup programs. Your system should have been fine-tuned before shipping. Improper setup may cause the system to fail, so consult your dealer before making any changes.

Virus Warning

When enabled, it assigns the BIOS to monitor the master boot sector and the DOS sector of the first hard disk drive.

The options are: Disabled (Default), Enabled.

CPU Internal Cache

When enabled, it improves system performance. Disable this item when testing or troubleshooting.

The options are: Enabled (Default), Disabled.

External Cache

When enabled, supports an external cache SRAM.

The options are: Enabled (Default), Disabled.

Quick Power On Self Test

When enabled, allows the BIOS to bypass the extensive memory test.

The options are: Disabled (Default), Enabled.

Boot Sequence

Allows the system BIOS to first try to boot the operating system from the selected disk drive.

The options are: A, C (Default); C (only); C, CDROM, A; CDROM, C, A.

Swap Floppy Drive

When enabled, allows you to switch the order in which the operating system accesses the floppy drives during boot-up.

The options are: Disabled (Default), Enabled.

Boot Up Floppy Seek

When enabled, assigns the BIOS to perform floppy disk drive tests by issuing seek commands. Note that such tests are time-consuming.

The options are: Enabled (Default), Disabled.

Boot Up NumLock Status

When set to "On", allows the BIOS to automatically enable the NumLock function when the system boots up.

The options are: On (Default), Off.

Memory Parity Check

The options are: Disabled (Default), Enabled.

Typematic Rate Setting

The term typematic means that when a keyboard key is held down, the character is repeatedly entered until the key is released. When this item is enabled, you may change the typematic repeat rate.

The options are: Disabled (Default), Enabled.

Typematic Rate (Chars/Sec)

Sets the rate of a character repeat when the key is held down.

The options are: 6 (Default), 8, 10, 12, 15, 20, 24, 30.

Typematic Delay (msec)

Sets the delay time before a character is repeated.

The options are: 250 (Default), 500, 750, 1000 milliseconds.

Security Option

Allows you to set the security level of the system.

The options are: Setup (Default), System.

PCI/VGA Palette Snoop

When enabled, allows you to install an enhanced graphics adapter card. If your graphics adapter card does not support the Palette Snoop function, set at "Disabled" to avoid system malfunctions.

The options are: Disabled (Default), Enabled.

OS Select For DRAM > 64MB

If your operating system (OS) is OS2, select "OS2". Otherwise, stay with the default setting Non-OS2.

Video BIOS Shadow

When enabled, allows the BIOS to copy the video ROM code of the add-on video card to the system memory, giving faster access.

The options are: Enabled (Default), Disabled.

C8000-CBFFF Shadow through to DC000-DFFFF Shadow

When enabled, allows the BIOS to copy the BIOS ROM code of the add-on card to the system memory for faster access. It may improve the performance of the add-on card. Some add-on cards will not function properly if their BIOS ROM codes are shadowed. To use this option correctly, you need to know the memory address range used by the BIOS ROM of each add-on card.

The options are: Disabled (Default), Enabled.

9.5 Chipset Features Setup

Note: It is strongly recommended that setup items in this section NOT be changed, because advanced knowledge is required to effect such changes.

ROM PCI/ISA BIOS (2ASIIAKA) CHIPSET FEATURES SETUP AWARD SOFTWARE, INC.	
Auto Configuration : Enabled	CPU to PCI Burst Mem. WR: Disabled
L2 (WB) Tag Bit Length : 8bits	ISA Bus Clock Frequency : PCICLK/4
SRAM Back-to-Back : Enabled	System BIOS Cacheable : Enabled
NA# Enable : Enabled	Video BIOS Cacheable : Enabled
Starting Point of Paging: 1T	Memory Hole at 15M-16M : Disabled
Refresh Cycle Time (us) : 15.6	Linear Mode SRAM Support: Disabled
RAS Pulse Width Refresh : 5T	
RAS Precharge Time : 3T	
RAS to CAS Delay : 2T	
CAS# Pulse Width (FP) : 2T	
CAS# Pulse Width (ED0) : 1T	
RAMW# Assertion Timing : 3T	
CAS Precharge Time (FP) : 1T/2T	
CAS Precharge Time (ED0): 1T/2T	
SDRAM WR Retire Rate : X-2-2-2	ESC : Quit ↑↓←→ : Select Item
SDRAM Wait State Control: 1WS	F1 : Help PU/PD/+/- : Modify
Enhanced Memory Write : Disabled	F5 : Old Values (Shift) F2 : Color
Read Prefetch Memory RD : Enabled	F6 : Load BIOS Defaults
CPU to PCI Post Write : 4T	F7 : Load Setup Defaults

Figure 9-4: Chipset features setup screen

System BIOS Cacheable

When enabled, allows the ROM area F000H-FFFFH to be cacheable when the cache controller is activated. The recommended setting is "Disabled", especially for high speed CPUs (200 MHz and above).

Video BIOS Cacheable

When enabled, allows the system to use the video BIOS codes from SRAMs, instead of the slower DRAMs or ROMs.

The options are: Enabled (Default), Disabled.

Memory Hole at 15M-16M

When enabled, the memory hole at the 15 MB address will be relocated to the 15 ~ 16 MB address range of the ISA cycle when the processor accesses the 15 ~ 16 MB address area.

When disabled, the memory hole at the 15 MB address will be treated as a DRAM cycle when the processor accesses the 15 ~ 16 MB address.

The options are: Disabled (Default), Enabled.

9.6 Power Management Setup

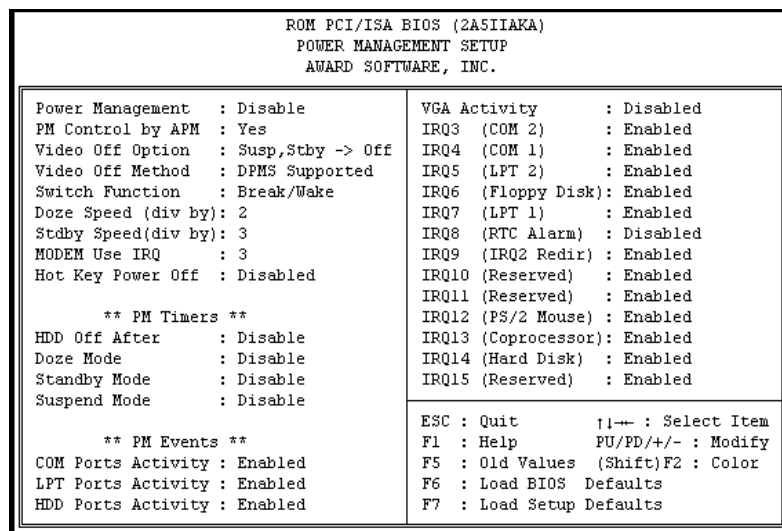

Figure 9-5: Power Management setup screen

Power Management

When enabled, allows you to use Power Management features.

The options are: Disabled (Default), Enabled.

PM Control by APM

The option "No" allows the BIOS to ignore the APM (Advanced Power Management) specification. Selecting "Yes" will allow the BIOS to wait for APM's prompt before it enters Doze mode, Standby mode, or Suspend mode. If the APM is installed, it will prompt the BIOS to set the system into power saving mode after all tasks are done.

The options are: Yes (Default), No.

Video Off Option

This feature provides the selections for the video display power saving mode. The option "Susp, Stby → Off" allows the video display to go blank if the system enters Suspend or Standby mode. The option "Suspend → Off" allows the video display to go blank if the system enters Suspend mode. The option "All Modes → Off" allows the video display to go blank if the system enters Doze mode or Suspend mode. The option "Always On" allows the video display to stay in Standby mode even when the system enters Doze or Suspend mode.

The options are: Susp, Stby → Off (Default), Suspend → Off, All Modes → Off, Always On.

Video Off Method

"DPMS Supported" allows the BIOS to blank off the screen display with your VGA card which supports DPMS (Display Power Management Signaling function). "Blank Screen" allows the BIOS to blank the screen display by turning off the red-green-blue signals.

The options are: DPMS Supported (Default), Blank Screen.

Doze Speed (div by)

The options are: 2 (Default), 1, 3, 4, 5, 6, 7, 8.

Stdby Speed (div by)

The options are: 3 (Default), 1, 2, 4, 5, 6, 7, 8.

MODEM Use IRQ

This feature allows you to select the IRQ# to meet your modem's IRQ#.

The options are: 3 (Default), 4, 5, 7, 9, 10, 11, NA.

Hot Key Power Off

This function is designated as "Disabled".

HDD Off After

Selecting "Disabled" will turn off the hard disk drive (HDD) motor.

Selecting "1 Min.. 15 Min" allows you to define the HDD idle time before the HDD enters Power Saving Mode.

The options "1 Min.. 15 Min" and "When Suspend" will not work concurrently. When the HDD is in Power Saving Mode, any access to the HDD will wake it up.

The options are: Disabled (Default), 1 Min.. 15 Min.

Doze Mode

The system will not enter Doze mode, because this option is designated as "Disabled".

Standby Mode

The system will not enter Standby mode, because this option is designated as "Disabled".

Suspend Mode

The system will not enter Suspend mode, because this option is designated as "Disabled".

COM Ports Activity

Selecting "Enabled" will enable the power management timer when a no activity event is detected in the COM ports. Selecting "Disabled" will disable the PM timer even if a no activity event is detected.

The options are: Enabled (Default), Disabled.

LPT Ports Activity

Selecting "Enabled" will enable the power management timer when a no activity event is detected in the LPT ports. Selecting "Disabled" will disable the PM timer even if a no activity event is detected.

The options are: Enabled (Default), Disabled.

HDD Ports Activity

Selecting "Enabled" will enable the power management timer when a no activity event is detected in the hard disk drive. Selecting "Disabled" will disable the PM timer even if a no activity event is detected.

The options are: Enabled (Default), Disabled.

VGA Activity

Selecting "Enabled" will enable the power management timer when a no activity event is detected in the VGA. Selecting "Disabled" will disable the PM timer even if a no activity event is detected.

The options are: Disabled (Default), Enabled.

IRQ# Activity

After the time period which you set in the Suspend Mode feature elapses, the system advances from Doze Mode to Suspend Mode, in which the CPU clock stops and the screen display is off. At this moment, if the IRQ activity which is defined as enabled occurs, the system goes directly back to Full-on Mode.

If the IRQ activity which is defined as "Disabled" occurs, the system enters another low power state, Dream Mode. In Dream Mode, the system will function the same as in Full-on Mode, except that the screen display remains off until the corresponding IRQ handler finishes, whereupon the system reverts to Suspend Mode.

For instance, if the system is connected to a LAN and receives an interruption from its file server, the system will enter Dream Mode to execute the corresponding calling routine.

The options are: Enabled, Disabled.

The default values of IRQ3, 4, 5, 6, 7, 9, 10, 11, 12, 13, 14, 15 are all: Enabled.

The default value of IRQ8 is: Disabled.

Note: Under certain operating systems such as Windows NT 4.0 (Build 1381), the CD auto-insertion feature might have some effect on power management. It is recommended that the CD-ROM drive use the secondary channel, and that the following Power Management Setup features be set:
HDD & FDD: Off
IRQ15 (Reserved): Secondary

9.7 PNP/PCI Configuration Setup

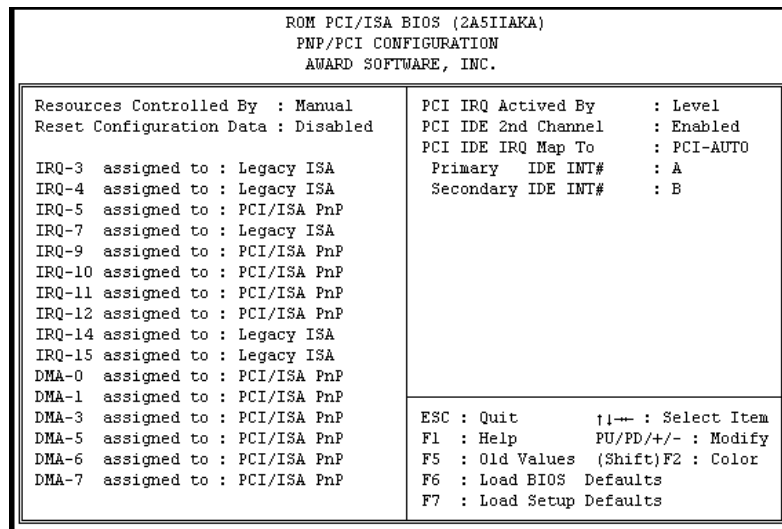

Figure 9-6: PNP/PCI configuration setup screen

Resources Controlled By

If set at "Auto", the BIOS automatically arranges all system resources for you. If there are conflicts or you are not satisfied with the configuration, simply set all the resources listed in the above figure by selecting "Manual".

The options are: Manual (Default), Auto.

The manual options assigned to IRQ-/DMA- are: Legacy ISA, PCI/ISA PnP.

Reset Configuration Data

When enabled, this feature allows the system to clear the last BIOS configuration data and then reset the data with the default BIOS configuration data.

The options are: Disabled (Default), Enabled.

PCI IRQ Activated By

If your IDE card is triggered by edge, set it at "Edge".

The options are: Level (Default), Edge.

PCI IDE 2nd Channel

This item allows you to designate an IDE controller board inserted into one of the PCI slots as your secondary IDE controller.

The options are: Enabled (Default), Disabled.

PCI IDE IRQ Map To

This item allows you to configure your system to the type of IDE disk controller that you are using. By default, Setup assumes that your controller is a PCI device rather than an ISA controller. The more apparent difference is the type of slot being used.

Your system is equipped with a PCI controller. Selecting PCI-AUTO allows you to specify which slot has the controller and which PCI interrupt (A, B, C or D) is associated with the connected hard drives.

The options are: PCI-AUTO (Default), ISA.

Primary IDE INT #

Remember that this setting refers to the hard disk drive itself, rather than individual partitions.

Secondary IDE INT #

Since each IDE controller supports two separate hard drives, you can select the INT# for each. You will note that the primary has a lower interrupt than the secondary.

Selecting PCI-AUTO allows the system to automatically determine how your IDE disk system is configured.

9.8 Load BIOS Defaults

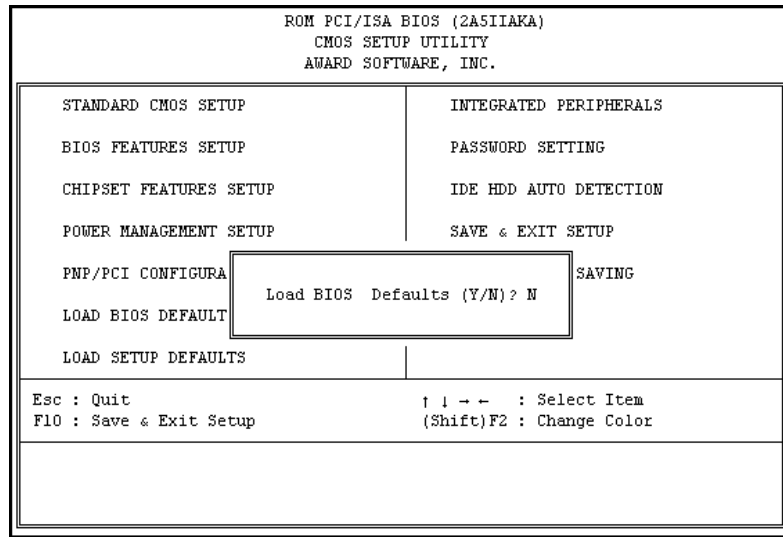

Figure 9-7: Load BIOS defaults screen

The BIOS defaults screen contains the most appropriate values of the system parameters that allow minimum system performance.

9.9 Load Setup Defaults

Selecting this field loads the factory defaults for BIOS and Chipset Features. The system will automatically detect these defaults.

9.10 Integrated Peripherals

ROM PCI/ISA BIOS (2AS11AKA) INTEGRATED PERIPHERALS AWARD SOFTWARE, INC.	
Internal PCI/IDE : Both	Onboard Serial Port 3 : 3E8/IRQ10
IDE Primary Master PIO : Auto	Onboard Serial Port 4 : 2E8/IRQ5
IDE Primary Slave PIO : Auto	Onboard Parallel Port : 378/IRQ7
IDE Secondary Master PIO: Auto	Parallel Port Mode : ECP+EPP
IDE Secondary Slave PIO: Auto	ECP Mode Use DMA : 3
Primary Master UltraDMA: Auto	WDT Active When Power ON : 63 sec
Primary Slave UltraDMA: Auto	PS/2 mouse function : Disabled
Secondary MasterUltraDMA: Auto	USB Controller : Disabled
Secondary Slave UltraDMA: Auto	Ethernet Boot Rom : Disabled
IDE Burst Mode : Disabled	Panel Type : 1024x768 DSTN
IDE Data Port Post Write: Enabled	
IDE HDD Block Mode : Enabled	
Onboard FDC Controller : Enabled	
Onboard Serial Port 1 : 3F8/IRQ4	ESC : Quit 1← : Select Item
Onboard Serial Port 2 : 2F8/IRQ3	F1 : Help PU/PD/+/- : Modify
IR Address Select : Disable	F5 : Old Values (Shift)F2 : Color
	F6 : Load BIOS Defaults
	F7 : Load Setup Defaults

Figure 9-8: Integrated peripherals screen

Internal PCI/IDE

When you select "Both", two PCI/IDE ports will be enabled. If you select "Disabled", both PCI/IDE ports will be enabled. You can also select one of two ports to be enabled by selecting "Primary" or "Secondary".

The options are: Both (Default), Disabled, Primary, Secondary.

IDE Primary/Secondary Master/Slave PIO

IDE hard disk drive controllers can support up to separate hard drives.

These drives have a master/slave relationship which is determined by the cabling configuration used to attach them to the controller. Your system supports two IDE controllers - a primary and a secondary - so you have the ability to install up to four separate hard disks.

PIO means Programmed Input/Output. Rather than having the BIOS issue a series of commands to effect a transfer to or from the disk drive, PIO allows the BIOS to tell the controller what it wants and then let the controller and the CPU perform the task by themselves.

Your system supports five modes, numbered from 0 through 4, which differ primarily in timing. When "Auto" is selected, the BIOS will choose the best available mode.

The options are: Auto, (Default), Disabled.

Primary/Secondary Master/Slave Ultra DMA

DMA means Direct Memory Access. Ultra DMA is faster than DMA. DMA is a method of transferring data to or from memory at a fast rate, without involving the CPU.

When you select "Auto", the BIOS will choose the best available mode.

The options are: Auto (Default), Disabled.

IDE Burst Mode

When enabled, data transfer on IDE buses will improve.

The options are: Disabled (Default), Enabled.

IDE HDD Block Mode

This allows your hard disk controller to use the fast block mode to transfer data to and from your hard disk drive (HDD).

The options are: Enabled (Default), Disabled.

Onboard FDD Controller

When enabled, the floppy disk drive (FDD) controller is activated.

The options are: Enabled (Default), Disabled.

WDT Active When Power ON

This is Advantech's patented watchdog function which can reboot the system should the computer hang in the BIOS checkup.

The options are: 63 sec (Default), Disabled, 31 sec, 15 sec.

Onboard Serial Ports 1 & 2

If the serial ports use the onboard I/O controller, you can modify your serial port parameters.

The options for Port 1 are: 3F8/IRQ4 (Default), 2E8/IRQ3, Disabled, 2F8/IRQ3, 3E8/IRQ4.

The options for Port 2 are: 2F8/IRQ3 (Default), 3E8/IRQ4, 2E8/IRQ3, Disabled, 3F8/IRQ4.

IR Address Select

When enabled, the infrared receptor is activated.

The options are: Disabled (Default), Enabled.

Onboard Serial Ports 3 & 4

If the serial ports use the onboard I/O controller, you can modify your serial port parameters.

The options for Port 3 are: 3E8/IRQ10 (Default), 2E8/IRQ5, Disabled.

The options for Port 4 are: 2E8/IRQ5 (Default), Disabled, 3E8/IRQ10.

Onboard Parallel Port

If the parallel port uses the onboard I/O controller, you can modify your parallel port parameters. When you select "Disabled", the next two setup items will disappear.

The options are: 378/IRQ7 (Default), 3BC/IRQ7, 278/IRQ5, Disabled.

Parallel Port Mode

You can choose different data transfer modes for your system.

The options are: ECP & EPP (Default), SPP, EPP, ECP.

ECP Mode Use DMA

You can choose different DMA modes for data transfer.

The options are: 3 (Default), 1.

PS/2 mouse function

When enabled, the PS/2 mouse is activated.

The options are: Disabled (Default), Enabled.

USB Controller

When enabled, the USB devices are activated.

The options are: Disabled (Default), Enabled.

Ethernet Boot ROM

When enabled, your system will be able to boot up through the Ethernet.

The options are: Disabled (Default), Enabled.

Panel Type

The panel type is designated by the manufacturer, according to your LCD panel type.

9.11 Password Setting

To enable the password setting, select the item from the Standard CMOS Setup. You will be prompted to create your own password. Type your password up to eight characters and press "Enter". You will be asked to confirm the password. Type the password again and press "Enter". You may also press "Esc" to abort the selection and not enter a password. To disable the password, press "Enter" when you are prompted to enter the password. A message will appear, confirming the password is disabled.

Under the BIOS Features setup, if "System" is selected under the Security Option field and the Supervisor Password is enabled, you will be prompted for the supervisor password every time you try to enter the CMOS Setup utility. If "System" is selected and User Password is enabled, you will be requested to enter the user password every time you reboot the system. If "Setup" is selected under the Security Option field and User Password is enabled, you will be prompted only when you reboot the system.

9.12 IDE HDD Auto Detection

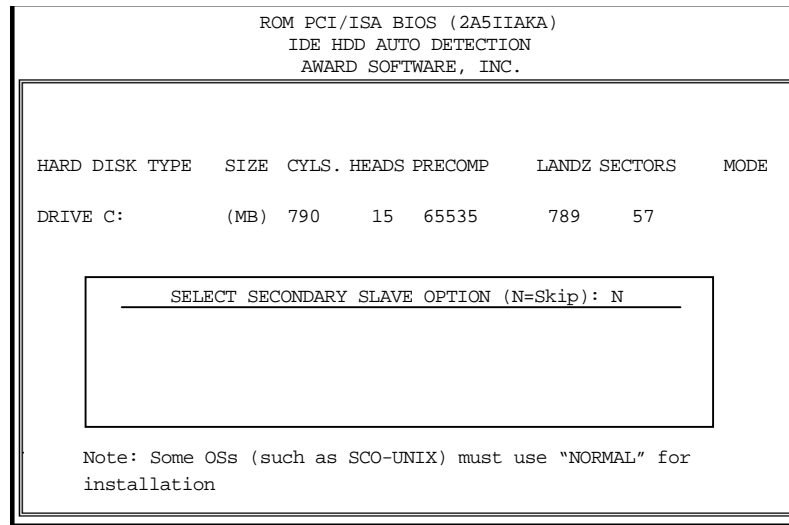

Figure 9-9: IDE HDD auto detection screen

The IDE Hard Disk Drive Auto Detection feature automatically configures your new hard disk. Use it for quick configuration of new hard disk drives. This feature allows you to set the parameters of up to four IDE HDDs. The option with "(Y)" is recommended by the system BIOS. You may also key in your own parameters instead of setting them according to the system BIOS. After keying in all settings, press "Esc" to return to the main menu. For confirmation, enter the Standard CMOS Setup feature.

9.13 Save and Exit Setup

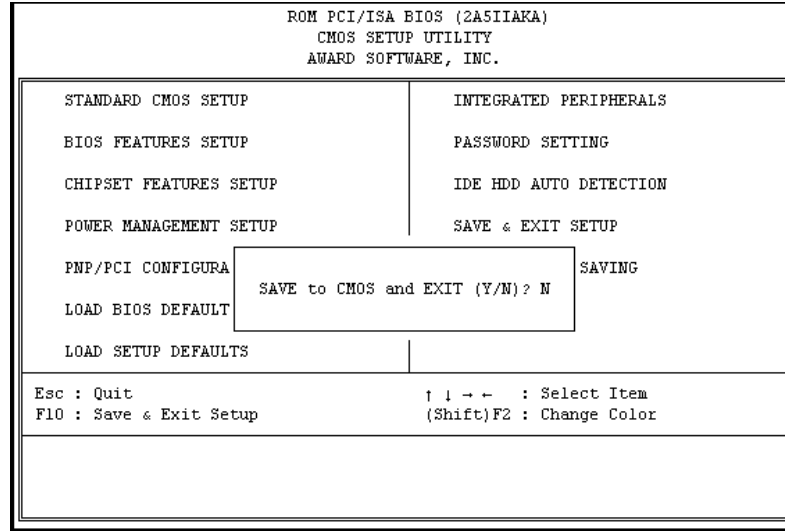

Figure 9-10: Save and exit setup screen

After you have made changes in the BIOS setup, press "Esc" to return to the main menu. Move the cursor to "Save and Exit Setup", or press "F10" and then press "Y", to change the CMOS Setup. If you did not change anything, press "Esc" again or move the cursor to "Exit Without Saving" and press "Y" to retain the setup settings. The following message will appear at the center of the screen to allow you to save data to CMOS and exit the setup utility:

```
SAVE to CMOS and EXIT (Y/N)?
```

9.14 Exit Without Saving

If you select this feature, the following message will appear at the center of the screen to allow you to exit the setup utility without saving CMOS modifications:

```
Quit Without Saving (Y/N) ?
```

CHAPTER 10

Touchscreen

- Introduction
- Installation of Touchscreen Driver
 - Installation for MS-DOS & WINDOWS 3.1
 - Installation for WINDOWS 95
 - Installation for WINDOWS NT
 - Installation for OS/2

10.1 Introduction

10.1.1 General information

The PPC-120/140's optional touchscreen incorporates advanced second-generation 5-wire resistive technology. It allows 75% light transmission and has an antiglare surface. This produces greatly enhanced visual resolution. It also has a newly improved scratch-resistant hard coating.

The touchscreen is manufactured from UL-recognized components (file no. E133802). When properly installed, the touchscreen's ball impact resistance meets the UL 1950 standard. Its fire resistance meets the UL-746C, 19 mm (0.75") flame test standard. Systems incorporating the touchscreen, controllers, and cables have been approved to FCC class A and B standards.

10.1.2 Specifications

Light Transmission: Typically 75% at 550 nanometers wavelength, optimized for flat-panel displays. All measurements as per ASTM D 10036-61

Visual Resolution: Antiglare: 6:1 minimum. Measured according to USAF 1951 Resolution Chart, under 30x magnification, with test unit located approximately 3.8 mm (1.5") from surface of resolution chart

Haze: Antiglare: less than 15%, as per ASTM D 103-61

Gloss: Antiglare: 96 ± gloss units, as per ASTM D 2457-70

10.1.3 Environmental specifications

Temperature: -10° ~ 50° C (operating)
-40° ~ 71° C (storage)

Relative humidity:
90 RH at 35° C (operating)
90 RH at 35° C for 240 hours, noncondensing (storage)

Chemical Resistance: The active area of the touchscreen is resistant to the following chemicals when exposed for a period of one hour at a temperature of 21° C (71° F):

- Acetone
- Methylene chloride
- Methyl ethyl ketone
- Isopropyl alcohol
- Hexane
- Ammonia-based glass cleaners
- Turpentine
- Mineral spirits
- Foods and beverages

10.2 Installation of Touchscreen Driver

The touchscreen driver for Windows 95 contains a native, 32-bit driver designed for Windows 95 and a 32-bit control panel program for the PPC-120/140 system.

To facilitate the installation of the touchscreen driver, you should read the instructions in this chapter carefully before you attempt installation.

Note 1: The following windows illustrations are examples only. You must follow the flow chart instructions and pay attention to the instructions which then appear on your screen.

Note 2: The CD-ROM drive is designated as "D" throughout this chapter.

10.2.1 Installation for MS-DOS and WINDOWS 3.1

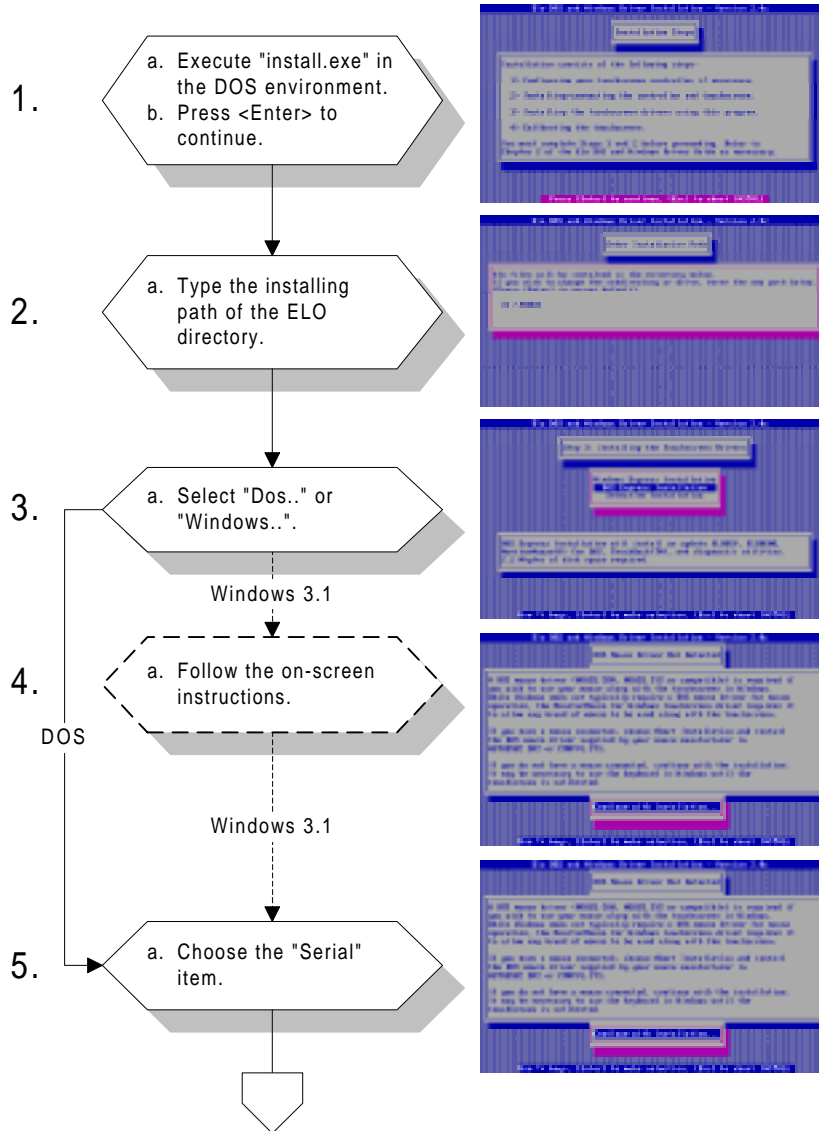

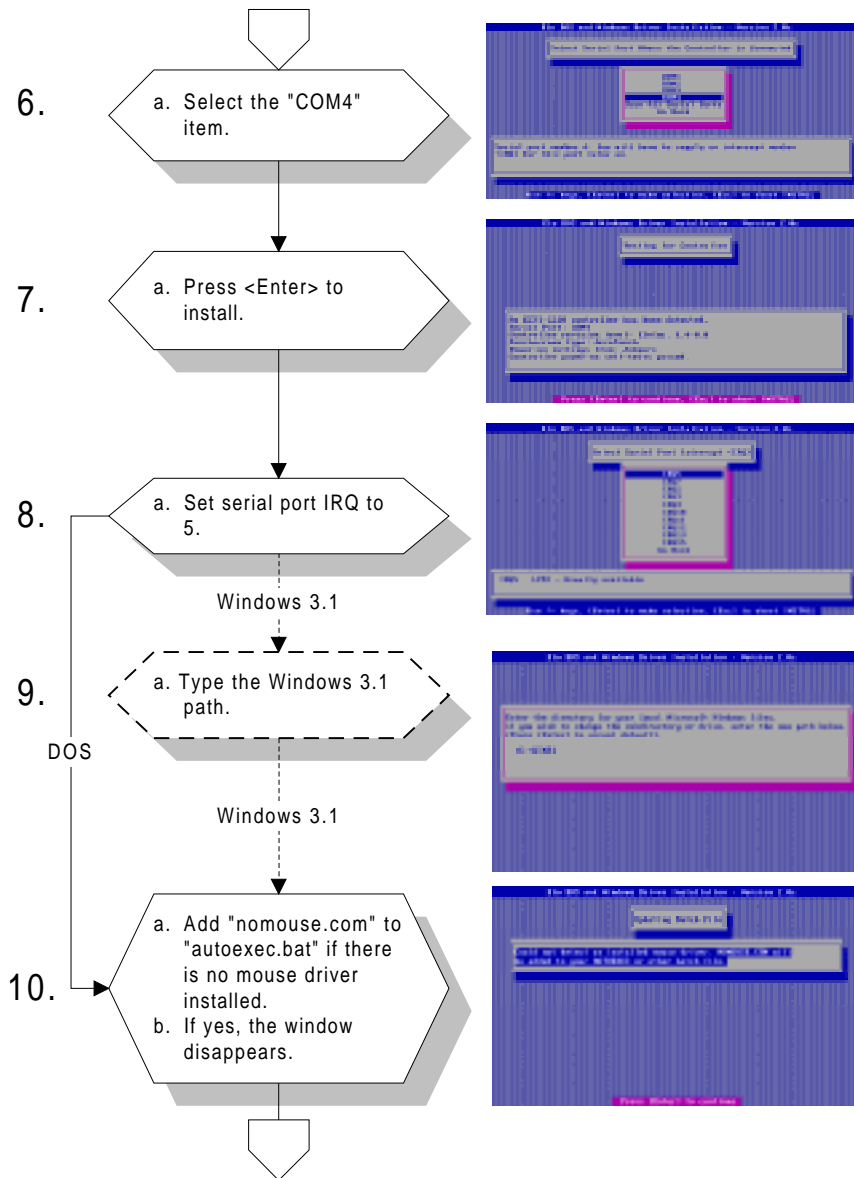

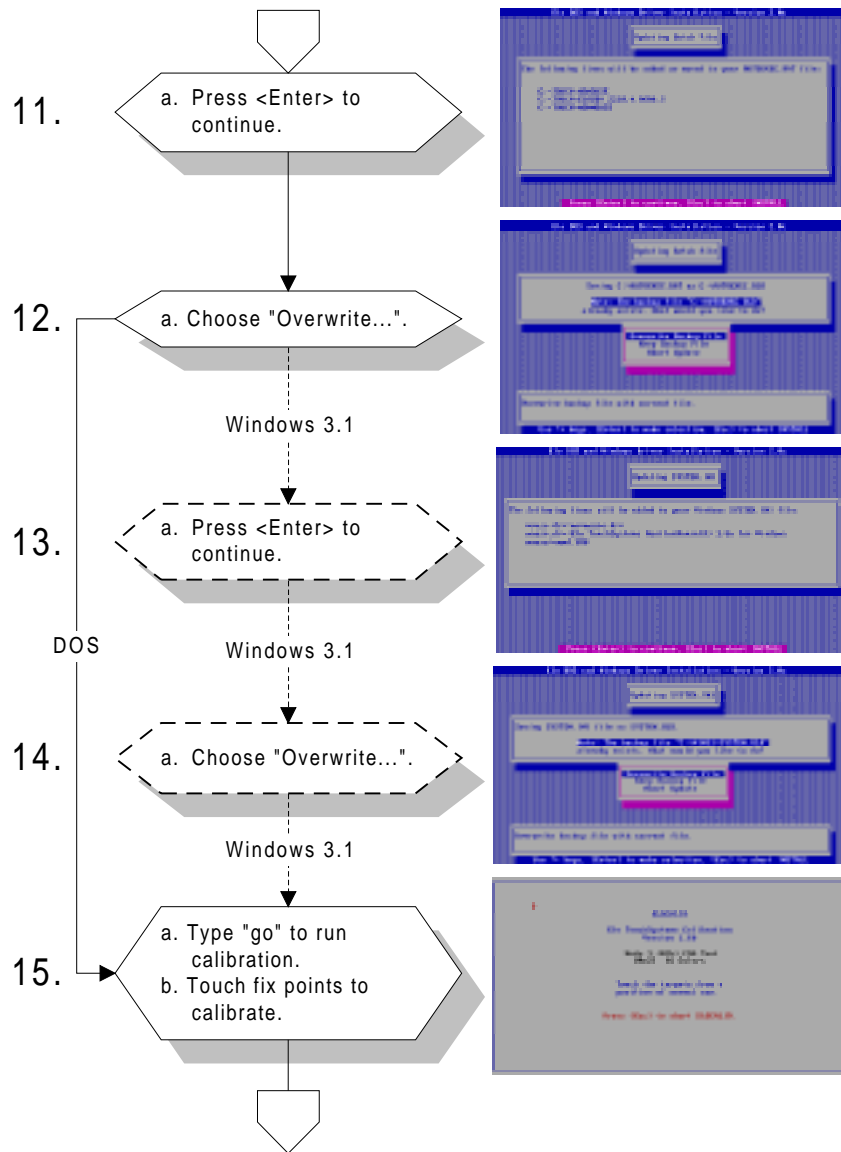

10.2.2 Installation for WINDOWS 95

If you want to use the touchscreen driver CD-ROM accompanying your panel PC, refer to the following flow chart instructions.

*Note: An alternative Windows 95 touchscreen driver is available. The touchscreen supplier, Elo TouchSystems Inc., has recently revised its Windows 95 touchscreen driver to support selection of four COM ports. This new feature enables users to set up the touchscreen driver without going through a long register-changing process. Although this new driver (version 1.86) has not yet been formally released by Elo TouchSystems, it can be downloaded from their website: **www.elotouch.com** Advantech will provide this new driver as soon as Elo TouchSystems verifies its validity.*

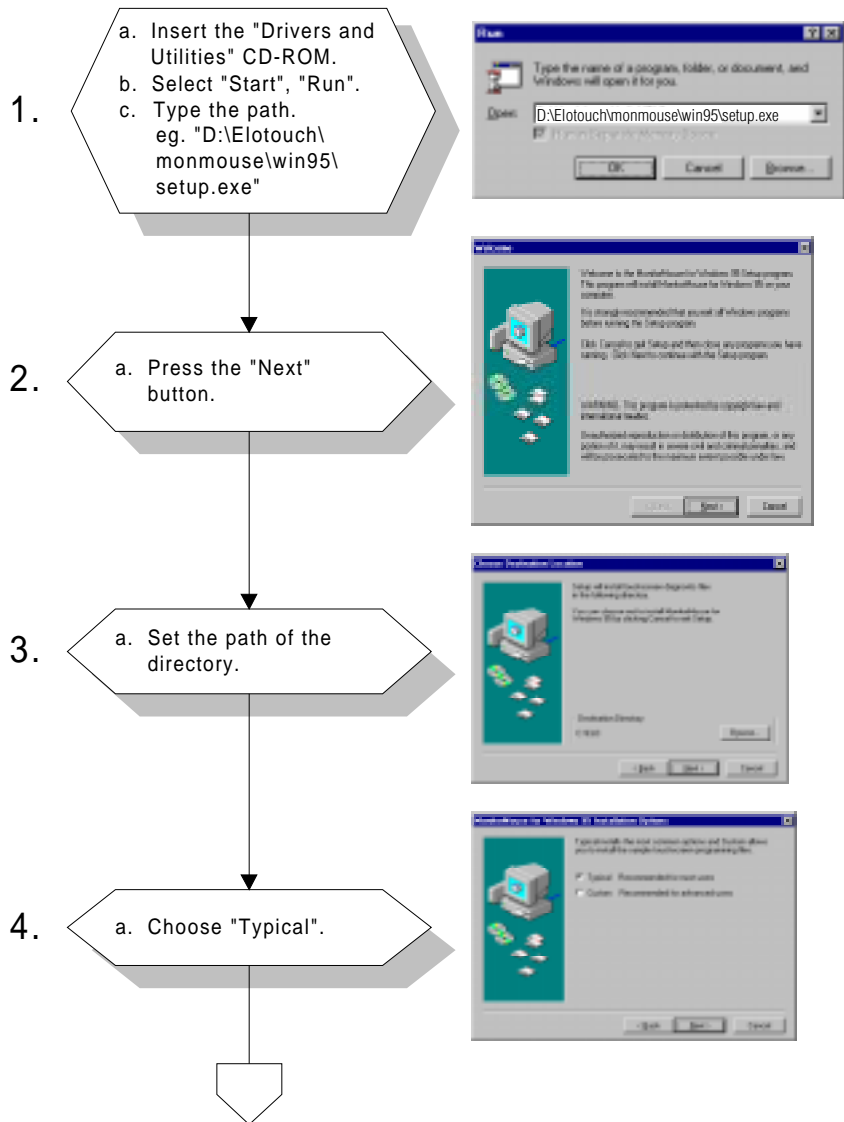

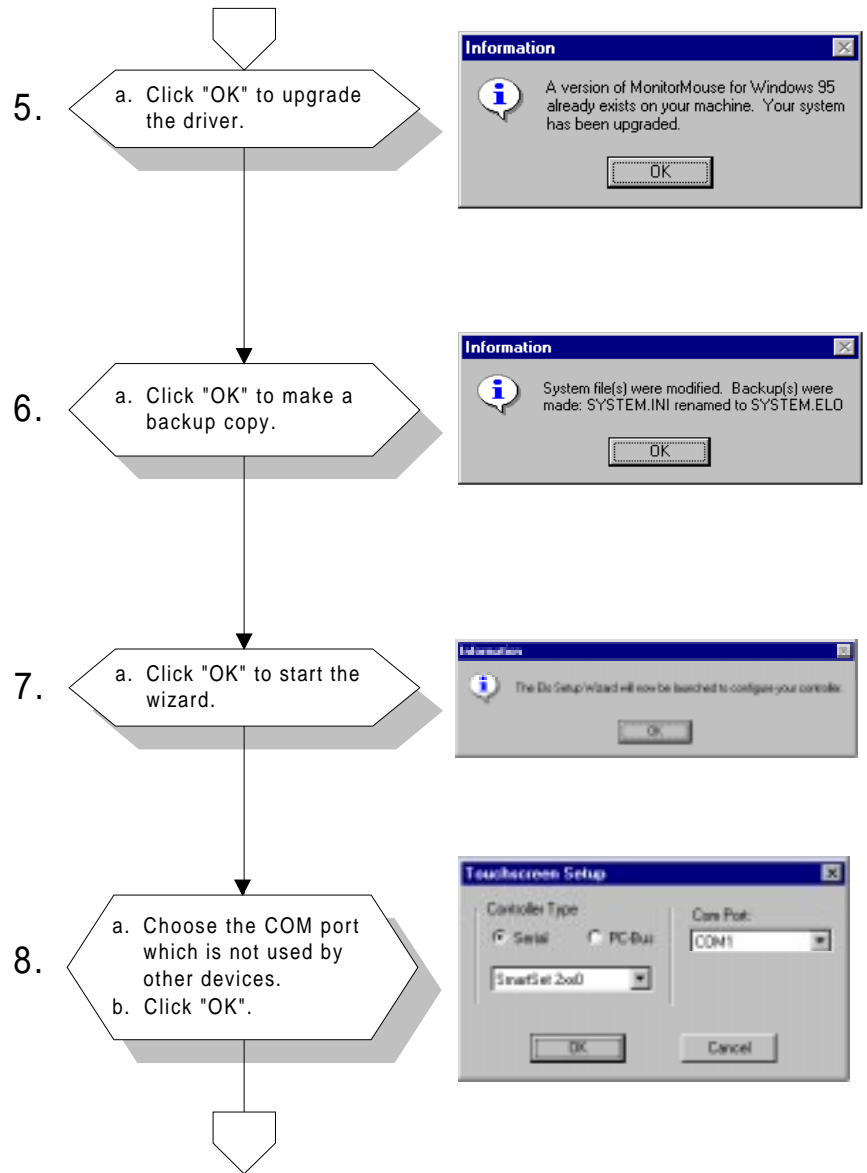

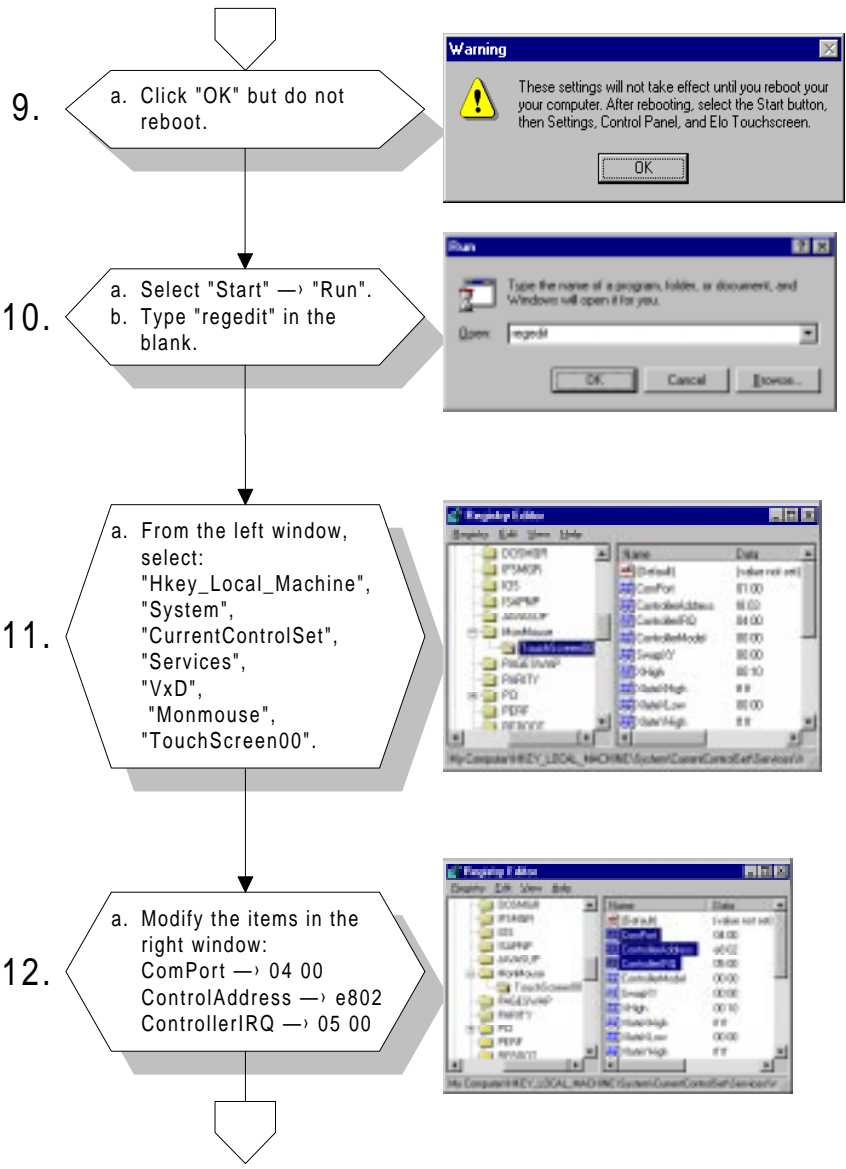

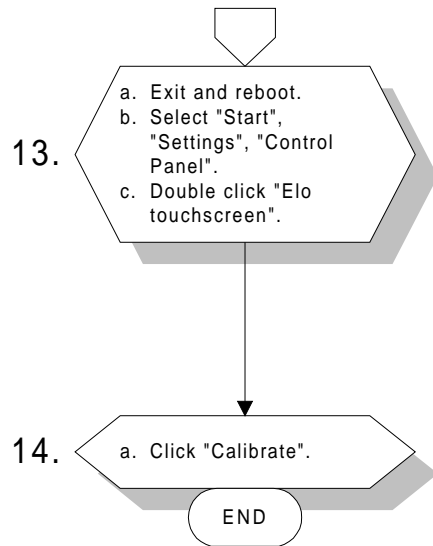

10.2.3 Installation for WINDOWS NT

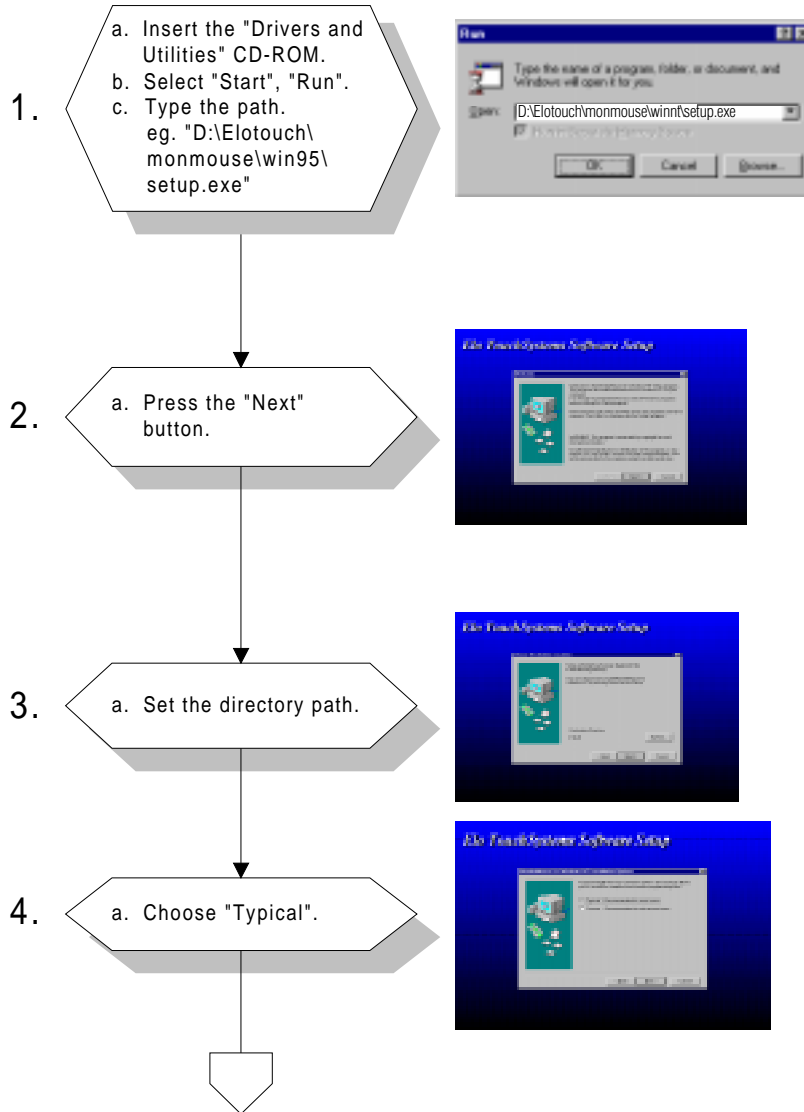

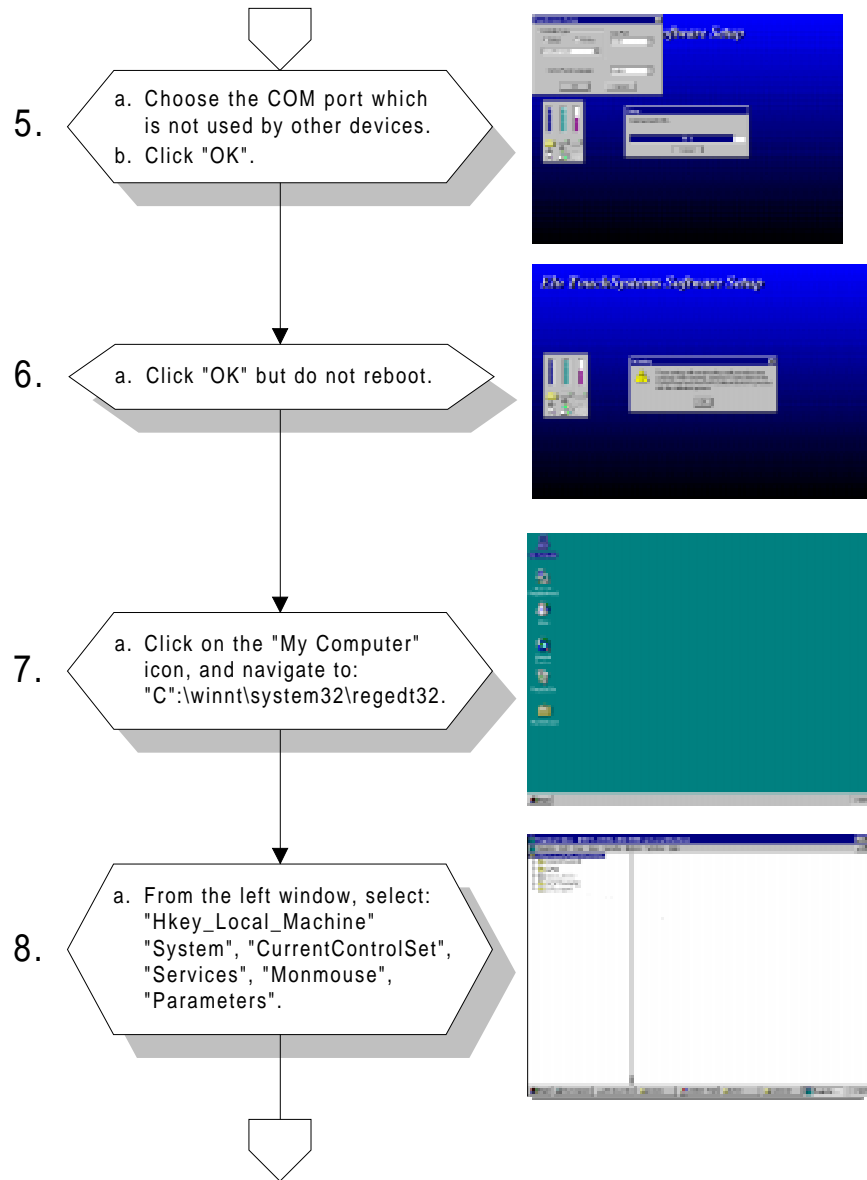

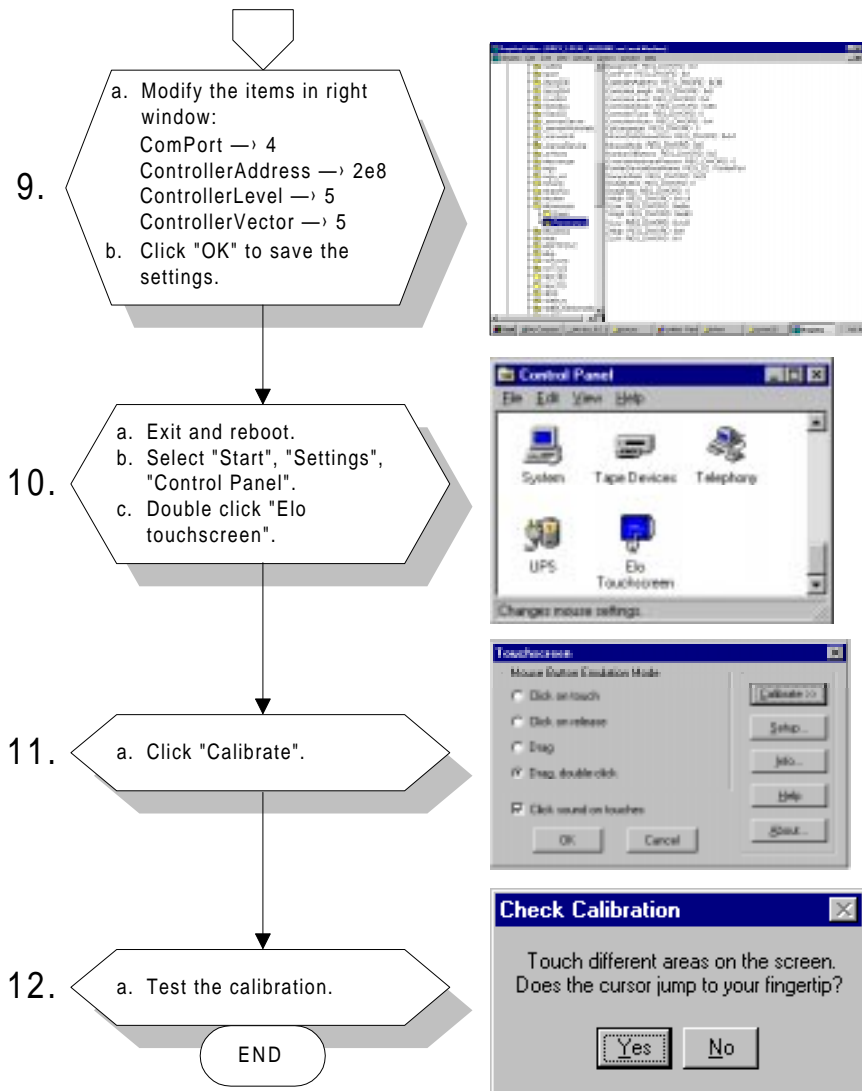

10.2.4 Installation for OS/2 (MonitorMouse)

BEFORE YOU BEGIN

First be sure OS/2 is installed and operating properly with your mouse. As you will be modifying the CONFIG.SYS file, it is best to have the OS/2 installation disks or a bootable DOS disk readily available. This way, any problems in CONFIG.SYS which cause the system not to boot can be corrected by rebooting from the disk(s).

Five steps are required when installing MonitorMouse for OS/2:

Step 1 - Configure your Controller

Step 2 - Copy the Software

Step 3 - Modify CONFIG.SYS

Step 4 - Install the Touchscreen Control Panel

Step 5 - Calibrate the Touchscreen

STEP 1 - CONFIGURE YOUR CONTROLLER

Verify your controller configuration. Elo typically ships touchscreen controllers preconfigured for use with Elo software, including MonitorMouse for OS/2. Configuration requires setting switches and/or installing jumpers that determine controller operating parameters. You will need these parameters when you install the MonitorMouse for OS/2 driver software. For controller installation instructions, refer to the IntelliTouch Product Manual or the AccuTouch Product Manual.

STEP 2 - COPY THE SOFTWARE

The following files are on the MonitorMouse for OS/2 disk:

!READ.ME!	Text file containing any additions or changes made after this manual was printed.
MONMOU01.SYS	Touchscreen driver for serial touchscreen controllers on PC bus systems.
MONMOU02.SYS	Touchscreen driver for serial touchscreen controllers on Micro Channel systems.
MONMOU03.SYS	Touchscreen driver for PC bus and Micro Channel touchscreen controllers.
ELOCAL2.EXE	Touchscreen control panel software program used to calibrate the touchscreen and to select options.
ELOCAL2.DLL	Used by ELOCAL2.EXE.
ELOCAL2.HLP	Help file for ELOCAL2.EXE.
ELO.BMP	Elo desktop wallpaper.
@6253.ADF	Description file for the E271-2202 Micro Channel touchscreen controller.
COMDUMP.EXE	DOS program for testing serial touchscreen controllers.
BUSSTAT.EXE	DOS program for testing PC bus touchscreen controllers.
SAWDUMP.EXE	DOS program for testing IntelliTouch touchscreen controllers.

Create a subdirectory on your hard disk and copy the files into it. For example:

```
CD \  
MD ELO  
COPY A:*. * ELO
```

International versions of the touchscreen control panel software program are included in subdirectories on the MonitorMouse for OS/2 disk. Replace ELOCAL2.DLL and ELOCAL2.HLP on your hard disk with the versions from the appropriate subdirectory.

STEP 3 - MODIFY CONFIG.SYS

MonitorMouse for OS/2 is installed by commands in CONFIG.SYS. Use your system editor to make these changes. In general, the changes are as follows:

1. Comment-out the existing DEVICE command(s) for your mouse.
2. Add a DEVICE command for the appropriate MonitorMouse for the OS/2 touchscreen driver immediately after the commented-out DEVICE commands(s).
3. Add a new DEVICE command for MOUSE.SYS.

The order of the DEVICE commands is important. Other changes may be required depending on your hardware configuration and version of OS/2.

Serial Touchscreen Controller on PC Bus System

Change your CONFIG.SYS file as follows:

```
Rem C:/OS2\MOUSE.SYS {Flags}

Device=c:\elo\monmou01.sys <controller>, <COM
port>,<baud rate>

Device=c:\os2\mouse.sys stype=elomou$ {Flags -
keep same as above}
```

Where:

<controller> is:

2300 for the IntelliTouch E281-2300 serial controller.

4002 for the IntelliTouch E281{A}-4002 serial controller.

2210 for the AccuTouch E271-2210 serial controller.

140 for the AccuTouch E271-140 serial controller.

<COM port> is:

the number of the COM port where the serial output of the touchscreen controller is connected.

<baud rate>

matches the switch or jumper settings on the controller.

Example MonitorMouse for OS/2 DEVICE command:

```
Device=c:\elo\monmou01.sys 2210,1,9600
```

No Mouse

If you do not wish to have a mouse connected, change the “styp=elomou\$” flag to “type=elomou\$” on the DEVICE=MOUSE.SYS command.

Disabling the COM Drivers

If your system COM ports are being used by the touchscreen and mouse, REM out the DEVICE=COM.SYS and DEVICE=VCOM.SYS commands (if present) in CONFIG.SYS. This prevents the COM drivers from displaying a message saying the COM port is unavailable.

If only the touchscreen is using a COM port, move the DEVICE=COM.SYS and DEVICE=VCOM.SYS commands before the DEVICE=MONMOU02.SYS command in CONFIG.SYS. Then add the flag (<COM Port>,0,0) to COM.SYS, where <COM Port> is the same as on the DEVICE=MONMOU01.SYS command. For example,

```
Device=c:\os2\com.sys (1,0,0)
```

STEP 4 - INSTALL THE TOUCHSCREEN CONTROL PANEL

The touchscreen control panel software program, ELOCAL2.EXE, is a presentation manager application for calibrating the touchscreen and setting various options.

Add the \ELO\ELOCAL2.EXE program to the System Setup folder and label the icon "Touchscreen". This is accomplished as follows:

1. Open the OS/2 System folder, then System Setup.
2. Open the Templates folder.
3. Drag the Program template with the right mouse button into the System Setup folder. A Settings notebook will be displayed.
4. Enter "C:\ELO\ELOCAL2.EXE" as the path and file name. Enter "C:\ELO" as the working directory.
5. Select the "General" tab. Change the Title to "Touchscreen".
6. Close the notebook.

See your OS/2 documentation for detailed instructions on installing new applications.

STEP 5 - CALIBRATE THE TOUCHSCREEN

Double-click the Touchscreen icon with the mouse (as the touchscreen may not be calibrated yet), or use the keyboard if the mouse is not connected. You may also run ELOCAL2.EXE from an OS/2 Window prompt.

Select "Calibrate" and follow the on-screen instructions. After calibrating, the touchscreen will work like the mouse. The DEVICE=MONMOUxx command in CONFIG.SYS is updated with the new calibration points (-c flag). The calibration points are then set automatically each time the system is started. Recalibration should only be necessary after moving or resizing the video image, or after changing either the touchscreen, controller, or monitor.

Close the touchscreen control panel.

**APPENDIX
A**

**LCD Specifications and
Selection Settings**

Table A-1: PPC-120/140 series LCD specifications

Model	PPC-140T	PPC-140S	PPC-120T
Display type (LCD)	13.8" TFT	13.8" DSTN	12.1" TFT
Max. resolution	1024 x 768	1024 x 768	800 x 600
Colors	256 K colors	256 K colors	256 K colors
Dot size (mm)	0.33 x 0.33	0.33 x 0.33	0.33 x 0.33
View angle	120°	90°	120°
Luminance	250 cd/m ²	200 cd/m ²	250 cd/m ²
Temperature	0° ~ 50° C	0° ~ 40° C	0° ~ 50° C
*VR controls	*Brightness	*Brightness/ Contrast	*Brightness
Simultaneous mode	Yes	Yes	Yes
LCD MTBF	50,000 hours	50,000 hours	50,000 hours
Backlight MTBF	25,000 hours	25,000 hours	25,000 hours

* The VR control knobs are located on the I/O section on the rear cover of the panel PC.

Note: The color LCD display installed in the panel PC is high-quality and reliable. However, it may contain a few defective pixels which may not always illuminate. With current technology, it is impossible to completely eliminate defective pixels. Advantech is actively working to improve this technology.

APPENDIX **B**

Programming the Watchdog Timer

The PPC-120/140 is equipped with a watchdog timer that resets the CPU or generates an interrupt if processing comes to a standstill for any reason. This feature ensures system reliability in industrial standalone or unmanned environments.

Programming the Watchdog Timer

To program the watchdog timer, you must write a program which writes I/O port address 443 (hex). The output data is a time interval value. The value range is from 01 (hex) to 3F (hex), and the related time interval is from 1 sec. to 63 sec.

Data	Time Interval
01	1 sec.
02	2 sec.
03	3 sec.
04	4 sec.
•	•
•	•
•	•
3F	63 sec.

After data entry, your program must refresh the watchdog timer by rewriting the I/O port 443 (hex) while simultaneously setting it. When you want to disable the watchdog timer, your program should read I/O port 443 (hex).

The following example shows how you might program the watchdog timer in BASIC:

```
10      REM  Watchdog timer example program
20      OUT &H443, data REM  Start and restart the watchdog
30      GOSUB 1000 REM  Your application task #1,
40      OUT &H443, data REM  Reset the timer
50      GOSUB 2000 REM  Your application task #2,
60      OUT &H443, data REM  Reset the timer
70      X=INP (&H443) REM, Disable the watchdog timer
80      END

1000     REM  Subroutine #1, your application task
        .
        .
        .
1070     RETURN
2000     REM  Subroutine #2, your application task
        .
        .
        .
2090     RETURN
```

APPENDIX

C

**Full Disassembly
Procedures**

If you want to completely disassemble the panel PC, follow the step-by-step procedures below. Users should be aware that Advantech Co., Ltd. takes no responsibility whatsoever for any problems or damage caused by the user's disassembly of the panel PC. Make sure the power cord of the panel PC is unplugged before you start disassembly.

The following procedures do not include the detailed disassembly procedures for the CPU, HDD, CD-ROM drive, FDD, and SRAM; all of which can be found in Chapter 4.

1. Unscrew the seven screws on the rear cover, and remove it. The PCI/ISA expansion slot cover can be detached by removing the two additional screws.
2. Remove the side panel by pushing it outward.
3. Unscrew the four screws that attach the CPU cover.
4. Detach the flat cable of the HDD, FDD and CD-ROM drive. Remove the two screws on the PCI/ISA bus expansion card. Remove the ten screws on the side rim of the shielding case. Carefully move the shielding case to the right to bypass the eject buttons of the PCMCIA slot, before removing the case from the machine. The electric fan and power inlet can also be removed from the case by unscrewing the screws.

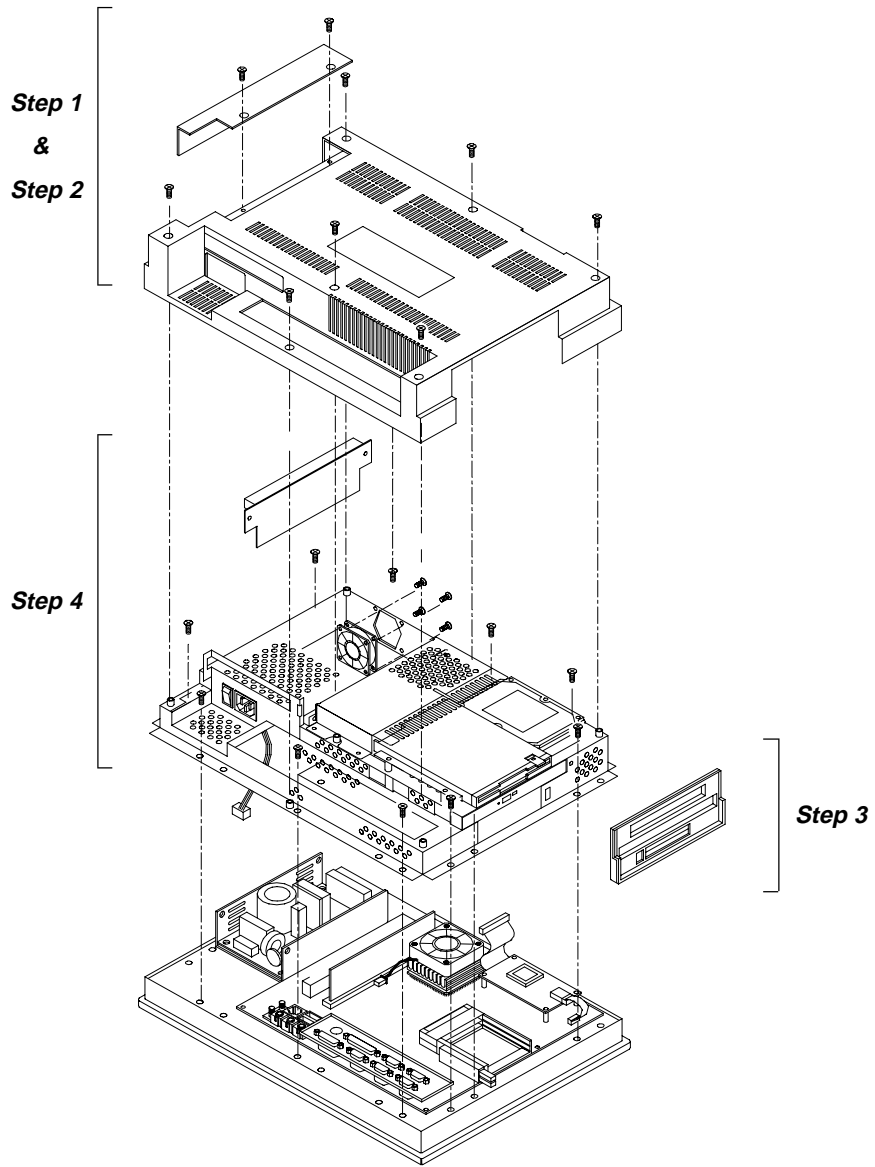

Figure C-1: Steps 1 - 4

5. Unscrew the fourteen screws of the I/O bracket with a hexagonal screwdriver. The EMI protection cover lies below the I/O bracket. You can now remove both the bracket and the cover from the I/O ports.
6. Detach the flat cables of the speakers, LCD inverter, touchscreen and LCD from the motherboard. You can remove the motherboard from the LCD holding plate.

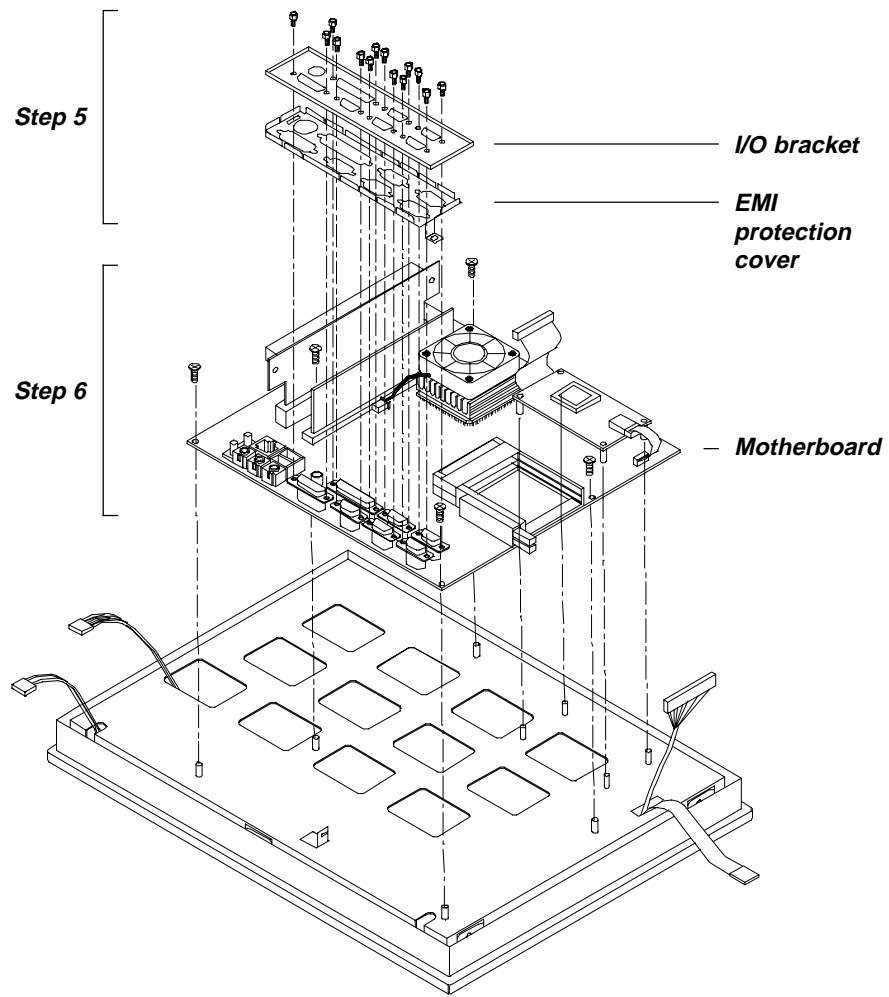

Figure C-2: Steps 5 - 6

7. Unscrew the four screws on the power supply board. The power supply board can be detached from the LCD holding plate after unplugging the two cables from the power inlet and motherboard.
8. Detach the LCD holding plate and LCD by unscrewing the four screws at the bottom. The LCD inverter can also be detached by unscrewing the three screws at the bottom.
9. Detach the cables of the LCD, touchscreen, LCD inverter and speaker from the holes of the holding plate.
10. Detach the touchscreen by removing it from the LCD. The rubber pad around the touchscreen and glass can also be detached.
11. The speakers are located on the two sides of the front cover.

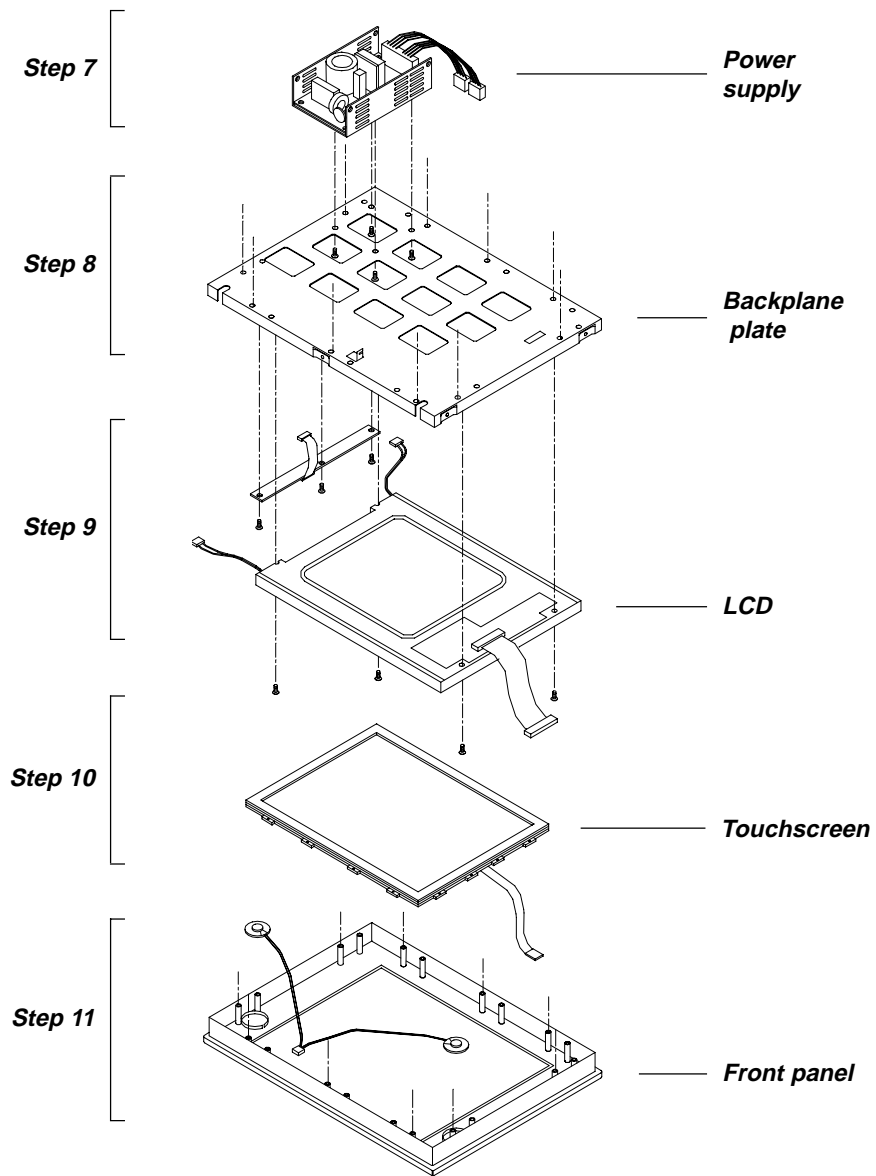

Figure C-3: Steps 7 - 11

APPENDIX D

Pin Assignments

- IR Connector (J1)
- Flat Panel Display Connector (J2)
- Flat Panel Display Connector (J3)
- Internal COM4 Connector (J4)
- Touchscreen Power Connector (J5)
- Sandisk SSD Connector (J6)
- EIDE Hard Disk Drive Connector (J7)
- Floppy Drive Connector (J8)
- CD-ROM Connector (J9)
- CPU Fan Power Connector (J10)
- PCI/ISA Bus Expansion Connector (J11)
- Fan Power Connector (J12)
- AT Power Connector (J13)
- ATX Power Connector (J14) (Reserved)
- Internal Speaker Connector (J15)
- Inverter Power Connector (J16)
- COM2

IR Connector (J1)

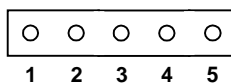

Table D-1: IR Connector (J1)

Pin	Signal
1	V _{CC}
2	Mode_Select
3	IR_IN
4	GND
5	IR_out

Flat Panel Display Connector (J2)

Table D-2: Flat Panel Display Connector (J2)

Pin	Signal	Pin	Signal
1	+12 V	2	+12 V
3	GND	4	GND
5	V _{DD} SAFE	6	V _{DD} SAFE
7	ENAVEE	8	GND
9	P0	10	P1
11	P2	12	P3
13	P4	14	P5
15	P6	16	P7
17	P8	18	P9
19	P10	20	P11
21	P12	22	P13
23	P14	24	P15
25	P16	26	P17
27	P18	28	P19
29	P20	30	P21
31	P22	32	P23
33	GND	34	GND
35	SHFCLK	36	FLM
37	M/DE	38	LP
39	GND	40	ENABKL
41	NC	42	NC
43	NC	44	NC

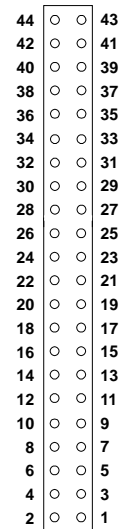

Flat Panel Display Connector (J3)

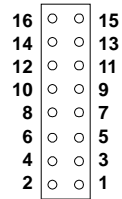

Table D-3: Flat Panel Display (J3)

Pin	Signal	Pin	Signal
1	V _{DD} SAFE	2	+5 V
3	P24	4	P25
5	P26	6	P27
7	P28	8	P29
9	P30	10	P31
11	P32	12	P33
13	P34	14	P35
15	GND	16	GND

Internal COM4 Connector (J4)

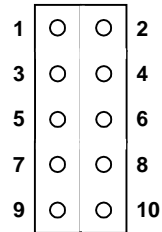

Table D-4: Internal COM4 Connector (J4)

Pin	Signal	Pin	Signal
1	DCD	2	DSR
3	RX	4	RTS
5	TX	6	CTS
7	DTR	8	RI
9	GND	10	GND

Touchscreen Power Connector (J5)



Table D-5: Touchscreen Power Connector (J5)

Pin	Signal
1	+5 V
2	GND

Sandisk SSD Connector (J6)

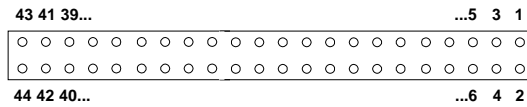

Table D-6: Sandisk SSD Connector (J6)

Pin	Signal	Pin	Signal
1	IDE RESET #	2	GND
3	DATA 7	4	DATA 8
5	DATA 6	6	DATA 9
7	DATA 5	8	DATA 10
9	DATA 4	10	DATA 11
11	DATA 3	12	DATA 12
13	DATA 2	14	DATA 13
15	DATA 1	16	DATA 14
17	DATA 0	18	DATA 15
19	SIGNAL GND	20	N/C
21	HDD 0	22	GND
23	IO WRITE	24	GND
25	IO READ	26	GND
27	HD READY	28	N/C
29	HDACK 0 #	30	GND
31	IRQ14	32	N/C
33	ADDR 1	34	N/C
35	ADDR 0	36	ADDR 2
37	HDD SELECT 0 #	38	HDD SELECT 1 #
39	IDE ACTIVE 0 #	40	GND
41	GND	42	V _{CC}
43	GND	44	N/C

Low active

EIDE Hard Disk Drive Connector (J7)

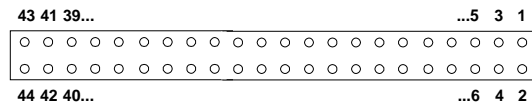

Table D-7: EIDE Hard Disk Drive Connector (J7)

Pin	Signal	Pin	Signal
1	IDE RESET #	2	GND
3	DATA 7	4	DATA 8
5	DATA 6	6	DATA 9
7	DATA 5	8	DATA 10
9	DATA 4	10	DATA 11
11	DATA 3	12	DATA 12
13	DATA 2	14	DATA 13
15	DATA 1	16	DATA 14
17	DATA 0	18	DATA 15
19	SIGNAL GND	20	N/C
21	HDD 0	22	GND
23	IO WRITE	24	GND
25	IO READ	26	GND
27	HD READY	28	N/C
29	HDACK 0 #	30	GND
31	IRQ14	32	N/C
33	ADDR 1	34	N/C
35	ADDR 0	36	ADDR 2
37	HDD SELECT 0 #	38	HDD SELECT 1 #
39	IDE ACTIVE 0 #	40	GND
41	GND	42	V _{cc}
43	GND	44	N/C

Low active

Floppy Drive Connector (J8)

Table D-8: Floppy Drive Connector (J8)

Pin	Signal	Pin	Signal
1	V _{CC} (+5 V)	14	STEP
2	INDEX	15	GND
3	V _{CC} (+5 V)	16	WRITE DATA
4	DRIVE SELECT	17	GND
5	V _{CC} (+5 V)	18	WRITE DATA
6	DISK CHANGE	19	GND
7	NC	20	TRACK 0
8	NC	21	GND
9	NC	22	WRITE PROTECT
10	MOTOR ON	23	GND
11	NC	24	READ DATA
12	DIRECTION	25	GND
13	DENSITY SELECT	26	SIDE 1 SELECT

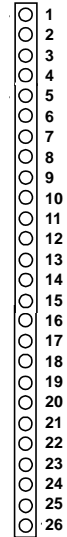

CD-ROM Connector (J9)

Table D-9: CD-ROM Connector (J9)

Pin	Signal	Pin	Signal
1	Audio_L	2	Audio_R
3	GND	4	GND
5	IDE RESET #	6	DATA8
7	DATA7	8	DATA9
9	DATA6	10	DATA10
11	DATA5	12	DATA11
13	DATA4	14	DATA12
15	DATA3	16	DATA13
17	DATA2	18	DATA14
19	DATA1	20	DATA15
21	DATA0	22	HDD 0
23	GND	24	IO READ
25	IO WRITE	26	GND
27	HD READY	28	HD ACK 0 #
29	IRQ 15	30	NC
31	ADDR1	32	NC
33	ADDR0	34	ADDR2
35	HDD SELECT 0 #	36	HDD SELECT 1 #
37	V _{cc} (+5 V)	38	V _{cc} (+5 V)
39	GND	40	GND

1	○	○	21
2	○	○	22
3	○	○	23
4	○	○	24
5	○	○	25
6	○	○	26
7	○	○	27
8	○	○	28
9	○	○	29
10	○	○	30
11	○	○	31
12	○	○	32
13	○	○	33
14	○	○	34
15	○	○	35
16	○	○	36
17	○	○	37
18	○	○	38
19	○	○	39
20	○	○	40

Low active

CPU Fan Power Connector (J10)



Table D-10: CPU Fan Power Connector (J10)

Pin	Signal
1	+12 V
2	GND

PCI/ISA Bus Expansion Connector (J11)

side view

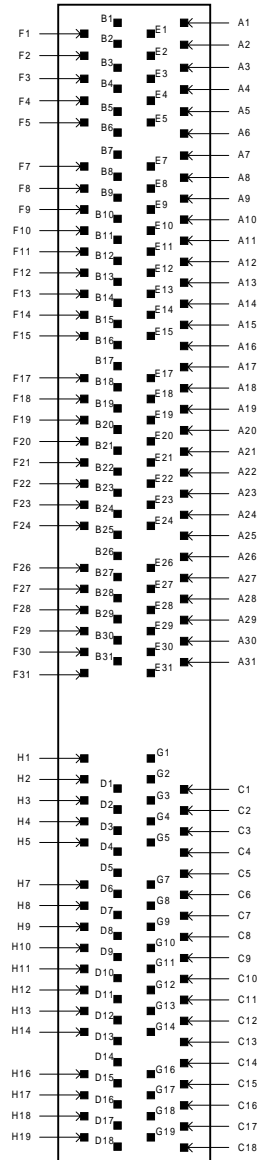

Table D-11: PCI/ISA Slot Pin Assignments (Pins A and B)

Pin	Signal	Pin	Signal
A1	IOCHK	B1	GND
A2	SD7	B2	RST
A3	SD6	B3	V _{cc}
A4	SD5	B4	IRQ9
A5	SD4	B5	-5 V
A6	SD3	B6	DRQ2
A7	SD2	B7	-12 V
A8	SD1	B8	OVS
A9	SD0	B9	+12 V
A10	IORDY	B10	GND
A11	AEN	B11	SMW
A12	SA19	B12	SMR
A13	SA18	B13	IOW
A14	SA17	B14	IOR
A15	SA16	B15	DACK3
A16	SA15	B16	DRQ3
A17	SA14	B17	DACK1
A18	SA13	B18	DRQ1
A19	SA12	B19	REF
A20	SA11	B20	SCLK
A21	SA10	B21	IRQ7
A22	SA9	B22	IRQ6
A23	SA8	B23	IRQ5
A24	SA7	B24	IRQ4
A25	SA6	B25	IRQ3
A26	SA5	B26	DACK2
A27	SA4	B27	TC
A28	SA3	B28	ALE
A29	SA2	B29	V _{cc}
A30	SA1	B30	OSC
A31	SA0	B31	GND

Table D-12: PCI/ISA Slot Pin Assignments (Pins C and D)

Pin	Signal	Pin	Signal
C1	SBHE	D1	MEM16
C2	LA23	D2	IO16
C3	LA22	D3	IRQ10
C4	LA21	D4	IRQ11
C5	LA20	D5	IRQ12
C6	LA19	D6	IRQ15
C7	LA18	D7	IRQ14
C8	LA17	D8	DACK0
C9	MEMR	D9	DRQ0
C10	MEMW	D10	DACK5
C11	SD8	D11	DRQ5
C12	SD9	D12	DACK6
C13	SD10	D13	DRQ6
C14	SD11	D14	DACK7
C15	SD12	D15	DRQ7
C16	SD13	D16	V _{cc}
C17	SD14	D17	MASTER
C18	SD15	D18	GND

Table D-13: PCI/ISA Slot Pin Assignments (Pins E and F)

Pin	Signal	Pin	Signal
E1	GND	F1	GND
E2	GND	F2	GND
E3	INT 1	F3	INT3
E4	INT 2	F4	INT4
E5	V _{cc}	F5	V _{cc}
E6	---	F6	---
E7	V _{cc}	F7	V _{cc}
E8	RST	F8	PCLK2
E9	GNT2	F9	(V)
E10	REQ2	F10	GNT3
E11	GND	F11	GND
E12	PCLK1	F12	REQ3
E13	GND	F13	AD31
E14	AD30	F14	AD29
E15	NC	F15	NC
E16	---	F16	---
E17	NC	F17	NC
E18	AD28	F18	AD27
E19	AD26	F19	AD25
E20	AD24	F20	CBE3
E21	AD22	F21	AD23
E22	AD20	F22	AD21
E23	AD18	F23	AD19
E24	NC	F24	NC
E25	---	F25	---
E26	---	F26	NC
E27	AD16	F27	AD17
E28	FRAME	F28	IRDY
E29	CBE2	F29	DEVSEL
E30	TRDY	F30	LOCK
E31	STOP	F31	PERR

Table D-14: PCI/ISA Slot Pin Assignments (Pins G and H)

Pin	Signal	Pin	Signal
G1	---	H1	SERR
G2	---	H2	AD15
G3	CBE1	H3	AD14
G4	PAR	H4	AD12
G5	GND	H5	GND
G6	---	H6	KEY
G7	GND	H7	GND
G8	AD13	H8	AD10
G9	AD11	H9	AD8
G10	AD9	H10	AD7
G11	CBEO	H11	AD5
G12	AD6	H12	AD3
G13	AD4	H13	AD1
G14	AD2	H14	AD0
G15	---	H15	KEY
G16	V _{CC}	H16	V _{CC}
G17	V _{CC}	H17	V _{CC}
G18	GND	H18	GND
G19	GND	H19	GND

Fan Power Connector (J12)



Table D-15: Fan Power Connector (J12)

Pin	Signal
1	+12 V
2	GND

AT Power Connector (J13)

Table D-16: AT Power Connector (J13)

Pin	Signal
1	NC
2	+5 V
3	+12 V
4	-12 V
5	GND
6	GND
7	GND
8	GND
9	-5 V
10	+5 V
11	+5 V
12	+5 V



ATX Power Connector (J14) (*Reserved)

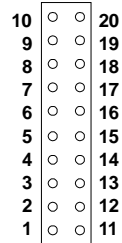

Table D-17: ATX Power Connector (J14)

Pin	Signal	Pin	Signal
1	+3.3 V	11	+3.3 V
2	+3.3 V	12	-12 V
3	GND	13	GND
4	+5 V	14	PS -ON
5	GND	15	GND
6	+5 V	16	GND
7	GND	17	GND
8	NC	18	-5 V
9	5VSB	19	+5 V
10	+12 v	20	+5 V

* Reserved for future expansion. There is no connector on the PC board.

Internal Speaker Connector (J15)

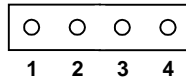

Table D-18: Internal Speaker Connector (J15)

Pin	Signal
1	Speaker out_L
2	GND
3	GND
4	Speaker out_R

Inverter Power Connector (J16)

Table D-19: Inverter Power Connector (J16)

Pin	Signal
1	+12 V
2	GND
3	ENABKL
4	Brightness Adj.
5	+5 V

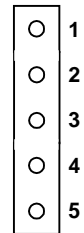

COM2

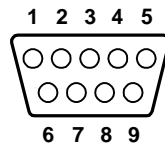

Table D-20: COM2

Pin	Signal		
	RS-232	RS-422	RS-485
1	DCD	TX-	DATA-
2	RX	TX+	DATA+
3	TX	RX+	---
4	DTR	RX-	---
5	GND	GND	---
6	DSR	---	---
7	RTS	---	---
8	CTS	---	---
9	RI	---	---

APPENDIX
E

Mounting Instructions

- Introduction
- Panel Mounting
- Desktop Stand Mounting

E.1 Introduction

The PPC-120/140 can be placed as is on a shelf or table, mounted into a panel, or mounted on a customized desktop stand.

E.2 Panel Mounting

Panel mounting can help system integrators conveniently integrate the panel PC into their system.

To construct a suitable panel, refer to the following cutout dimensions diagram.

Note: The panel thickness should not exceed 10 mm.

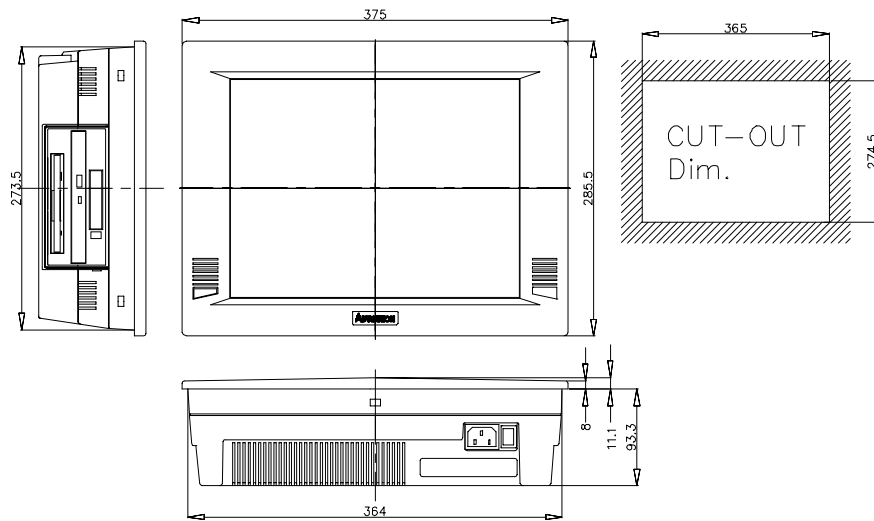

Figure E-1: Cutout dimensions of the PPC-120/140

To mount the PPC-120/140 into a panel:

1. There are six plastic caps located along the four sides of the panel PC. Pry them off with a flat-head screwdriver.
2. Insert the fixation wedges into the holes and tighten them with the screws provided.

Note: The panel thickness should not exceed 10 mm.

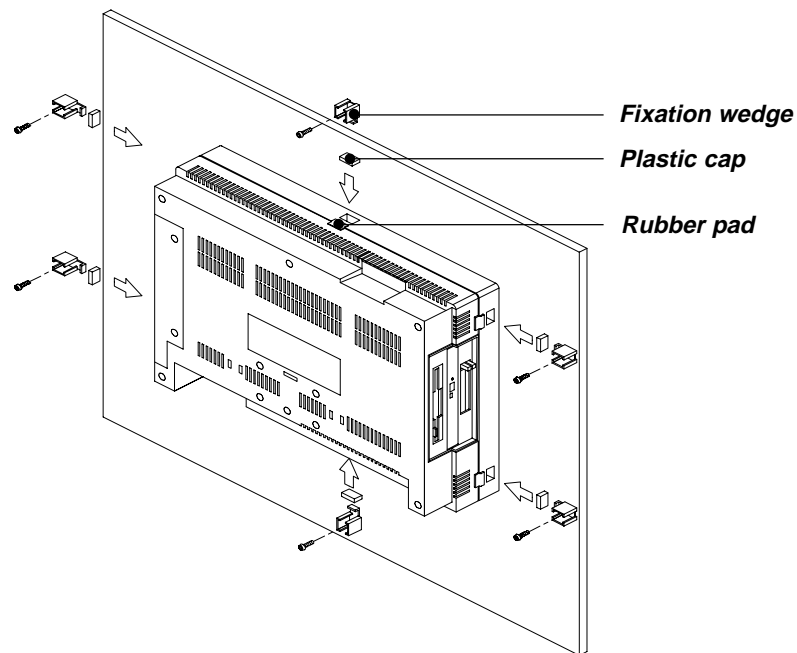

Figure E-2: Panel mounting

E.3 Desktop Stand Mounting

The PPC-120/140 has a customized stand suitable for desktops and other horizontal locations. A unique spring inside the stand enables the panel PC's vertical tilt to be adjusted about 30 degrees. The stand is available from Advantech Co.

Follow these procedures to set up the stand:

1. Remove the rear cover of the panel PC by unscrewing the seven screws.
2. Attach the holding plate of the stand to the inside of the rear cover of the panel PC using the five screws provided. (See Fig. E-3.)
3. Reattach the rear cover of the panel PC.
4. Attach the main body of the stand to the rear cover of the panel PC using the four screws provided.
5. Slide the main body of the stand into the stand base. Tighten it with the two screws provided.
6. Attach the rear cover of the stand to the main body of the stand by snapping the lugs of the rear cover into the slots of the main body. When the rear cover locks into place, you will hear a click.
7. Attach the top cover of the stand to the main body of the stand by snapping the lugs of the top cover into the slots of the main body. The cover must be rotated as it is snapped into place. When the top cover locks into place, you will hear a click.

Note: *The base of the stand has two plastic caps. If you pry off the caps, you can attach the stand to your desktop using the two screw holes.*

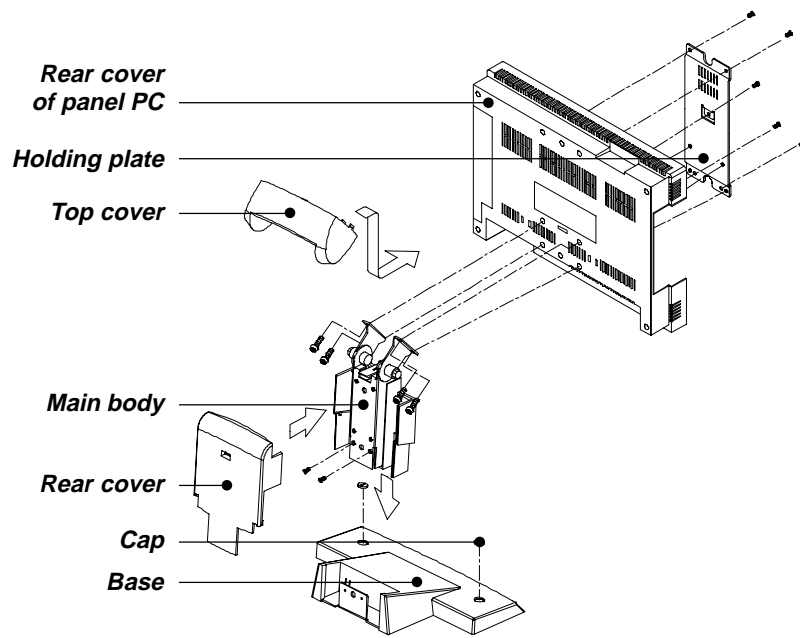

Figure E-3: Desktop stand mounting

E.4 Swingarm Stand Mounting

The PPC-120/140 can be mounted on a unique swingarm. This versatile swingarm is easy to install and operate, and allows for rotation at very wide-ranging angles. Its dimensions are as shown in Fig. E-4, and it is available from Advantech Co., Ltd.

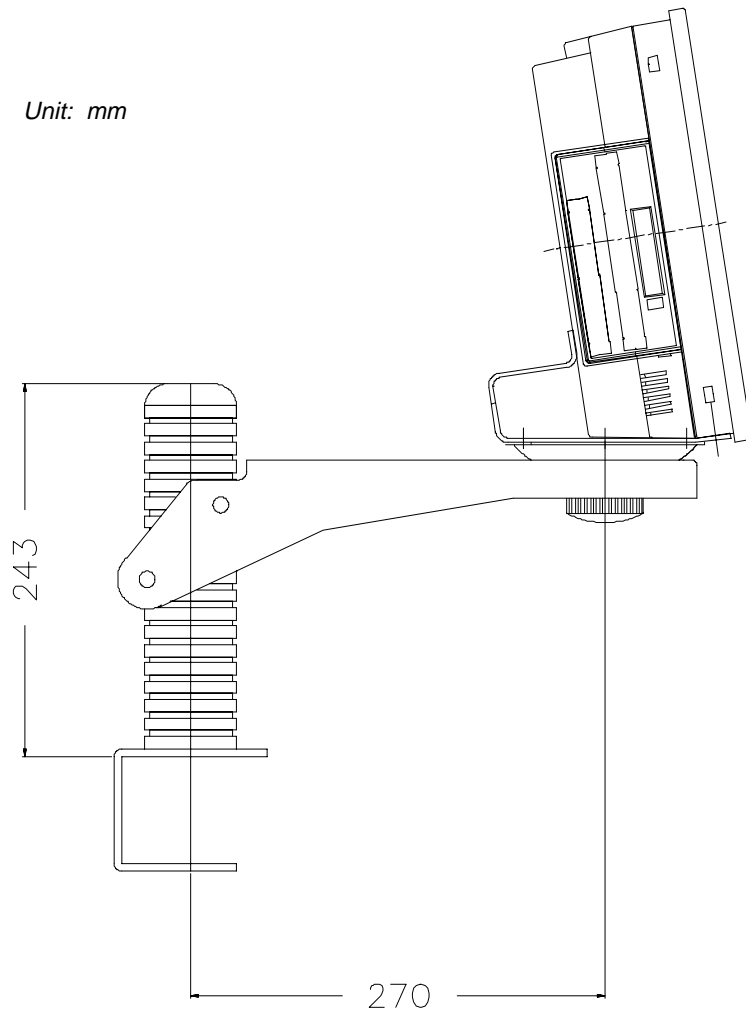

Figure E-4: Swingarm stand mounting

Free Manuals Download Website

<http://myh66.com>

<http://usermanuals.us>

<http://www.somanuals.com>

<http://www.4manuals.cc>

<http://www.manual-lib.com>

<http://www.404manual.com>

<http://www.luxmanual.com>

<http://aubethermostatmanual.com>

Golf course search by state

<http://golfingnear.com>

Email search by domain

<http://emailbydomain.com>

Auto manuals search

<http://auto.somanuals.com>

TV manuals search

<http://tv.somanuals.com>