User, Programming and Service Guide

Agilent 11896A Polarization Controller

Notice

The information contained in this document is subject to change without notice.

Agilent Technologies makes no warranty of any kind with regard to this material, including, but not limited to, the implied warranties of merchantability and fitness for a particular purpose. Agilent Technologies shall not be liable for errors contained herein or for incidental or consequential damages in connection with the furnishing, performance, or use of this material.

Agilent Part Number: 11896-90011
Printed in USA April 2000

©Copyright Agilent Technologies 2000
All Rights Reserved. Reproduction, adaptation, or translation without prior written permission is prohibited, except as allowed under the copyright laws.
1400 Fountaingrove Parkway, Santa Rosa, CA 95403-1799, USA

Certification

Agilent Technologies certifies that this product met its published specifications at the time of shipment from the factory. Agilent Technologies further certifies that its calibration measurements are traceable to the United States National Institute of Standards and Technology, to the extent allowed by the Institute's calibration facility, and to the calibration facilities of other International Standards Organization members.

Warranty

This Agilent Technologies instrument product is warranted against defects in material and workmanship for a period of one year from date of shipment. During the warranty period, Agilent Technologies will, at its option, either repair or replace products which prove to be defective.

For warranty service or repair, this product must be returned to a service facility designated by Agilent Technologies. Buyer shall prepay shipping charges to Agilent Technologies and Agilent Technologies shall pay shipping charges to return the product to Buyer. However, Buyer shall pay all shipping charges, duties, and taxes for products returned to Agilent Technologies from another country.

Agilent Technologies warrants that its software and firmware designated by Agilent Technologies for use with an instrument will execute its programming instructions when properly installed on that instrument. Agilent Technologies does not warrant that the operation of the instrument, or software, or firmware will be uninterrupted or error-free.

LIMITATION OF WARRANTY

The foregoing warranty shall not apply to defects resulting from improper or inadequate maintenance by Buyer, Buyer-supplied software or interfacing, unauthorized modification or misuse, operation outside of the environmental specifications for the product, or improper site preparation or maintenance.

NO OTHER WARRANTY IS EXPRESSED OR IMPLIED. AGILENT TECHNOLOGIES SPECIFICALLY DISCLAIMS THE IMPLIED WARRANTIES OF MERCHANTABILITY AND FITNESS FOR A PARTICULAR PURPOSE.

EXCLUSIVE REMEDIES

THE REMEDIES PROVIDED HEREIN ARE BUYER'S SOLE AND EXCLUSIVE REMEDIES. AGILENT TECHNOLOGIES SHALL NOT BE LIABLE FOR ANY DIRECT, INDIRECT, SPECIAL, INCIDENTAL, OR CONSEQUENTIAL DAMAGES, WHETHER BASED ON CONTRACT, TORT, OR ANY OTHER LEGAL THEORY.

Assistance

Product maintenance agreements and other customer assistance agreements are available for Agilent Technologies products.

For any assistance, contact your nearest Agilent Technologies Service Office.

Safety Symbols

The following safety symbols are used throughout this manual. Familiarize yourself with each of the symbols and its meaning before operating this instrument.

CAUTION

The *caution* sign denotes a hazard to the instrument. It calls attention to a procedure which, if not correctly performed or adhered to, could result in damage to or destruction of the instrument. Do not proceed beyond a *caution* sign until the indicated conditions are fully understood and met.

WARNING

The *warning* sign denotes a life-threatening hazard. It calls attention to a procedure which, if not correctly performed or adhered to, could result in injury or loss of life. Do not proceed beyond a *warning* sign until the indicated conditions are fully understood and met.

Instruction Manual

The **instruction manual** symbol. The product is marked with this symbol when it is necessary for the user to refer to the instructions in the manual.



General Safety Considerations

WARNING

Before this instrument is switched on, make sure it has been properly grounded through the protective conductor of the ac power cable to a socket outlet provided with protective earth contact.

Any interruption of the protective (grounding) conductor, inside or outside the instrument, or disconnection of the protective earth terminal can result in personal injury.

WARNING

This is a Safety Class I product (provided with a protective earthing ground incorporated in the power cord). The mains plug shall only be inserted in a socket outlet provided with a protective earth contact. Any interruption of the protective conductor inside or outside of the instrument is likely to make the instrument dangerous. Intentional interruption is prohibited.

WARNING

There are many points in the instrument which can, if contacted, cause personal injury. Be extremely careful.

Any adjustments or service procedures that require operation of the instrument with protective covers removed should be performed only by trained service personnel.

WARNING

If this instrument is not used as specified, the protection provided by the equipment could be impaired. This instrument must be used in a normal condition (in which all means for protection are intact) only.

NOTE

Clean the cabinet using a damp cloth only.

How to Use This Manual

This manual provides information about the Agilent 11896A polarization controller.

- | | |
|-------------------|--|
| Chapter 1 | provides general information and specifications for the controller |
| Chapter 2 | describes how to prepare the polarization controller for use and how to make fiber optic connections |
| Chapter 3 | shows how to manually control the lightwave polarization controller |
| Chapter 4 | shows how to control the lightwave polarization controller using a computer |
| Chapter 5 | provides procedures for verifying and servicing the Agilent 11896A polarization controller |
| Appendix A | selecting scan rate and measurement time |
| Appendix B | measurement considerations |
| Appendix C | provides a sample GPIB program |

Contents

1. General Information

Description	1-3
Instrument configuration	1-4
Options	1-4
Accessories	1-4
Polarization-dependent loss measurements	1-5
Power meter PDL measurement system	1-5
Swept-wavelength PDL measurement system	1-6
Max/min PDL measurement system	1-8
Theory of Operation	1-10
Specifications and Characteristics	1-11
Serial Numbers	1-14
Electrostatic Discharge Information	1-15
Reducing ESD damage	1-17

2. Installation and Preparation for Use

Preparing the Polarization Controller for Use	2-3
Initial inspection	2-3
Connecting the Agilent 11896A to a power source	2-4
Power requirements	2-4
Checking the fuse	2-4
Power cable	2-5
Turning on the Agilent 11896A	2-8
Lightwave Connector Care	2-9
Introduction	2-9
Cleaning and handling	2-11
Definition of terms	2-11
Handling	2-11
Cleaning	2-11
Cleaning non-lensed lightwave connectors	2-12
Equipment	2-12
Process	2-12
Cleaning lightwave adapters	2-13
Equipment	2-13
Process	2-13
Cleaning lensed connections	2-13

Storage	2-14
Making connections	2-15
Summary	2-16
Inspection	2-16
Visual inspection	2-16
Optical performance testing	2-17
Introduction	2-17
Insertion loss	2-17
Return loss	2-18
3. Using the Agilent 11896A Polarization Controller	
Front-Panel Features	3-3
Error codes	3-5
Rear-Panel Features	3-6
Using the Agilent 11896A	3-7
Power-up function	3-8
To use the Manual mode	3-8
To continuously sweep all polarization states	3-9
To set the scan rate	3-9
To save an instrument state	3-10
To recall an instrument state	3-10
To use the Local function	3-11
To display or change the GPIB address	3-11
4. Programming	
Changing the GPIB address	4-3
Talking to the Instrument	4-4
Program Message Syntax	4-5
Output command	4-5
Device address	4-5
Instructions	4-6
Instruction header	4-6
White space (separator)	4-6
Program data	4-7
Header types	4-7
Simple command header	4-7
Compound command header	4-8
Common command header	4-8
Combining commands	4-8
Duplicate mnemonics	4-9
Query command	4-10

Program header options	4-11
Program data syntax rules	4-12
Numeric program data	4-12
Program message terminator	4-13
Selecting multiple subsystems	4-13
Initialization	4-14
Programming over GPIB	4-15
Interface capabilities	4-15
Command and data concepts	4-15
Addressing	4-16
Communicating over the bus (HP 9000 series 200/300 controller)	4-17
Interface select code (selects interface)	4-17
Instrument address (selects instrument)	4-17
Lockout	4-18
Bus commands	4-18
Device clear	4-18
Interface clear	4-18
Common commands	4-19
*CLS (Clear Status)	4-19
*ESE (Event Status Enable)	4-20
*ESR (Event Status Register)	4-21
*IDN (Identification Number)	4-22
*OPC (Operation Complete)	4-22
*RCL (Recall)	4-23
*RST (Reset)	4-23
*SAV (Save)	4-23
*SRE (Service Request Enable)	4-24
*STB (Status Byte)	4-25
*TST (Test)	4-26
*WAI (Wait)	4-26
Instrument specific commands	4-27
:ABORt	4-27
:INITiate:IMMediate	4-27
:PADDle:POSition	4-28
:SCAN:RATE	4-29
:SCAN:TIMer	4-29
:SCAN:TIMer:CLEar	4-30
:STATus:OPERation :CONDition	4-30
:STATus:OPERation :ENABLE	4-30
:STATus:OPERation :EVENT	4-31

:STATus:PRESet	4-31
:STATus:QUEStionable :CONDition	4-31
:STATus:QUEStionable :ENABle	4-32
:STATus:QUEStionable :EVENT	4-32
:SYSTem:ERRor	4-33
:SYSTem:VERSion	4-34

5. Verification and Service Information

Performing a Verification Check	5-3
Verify startup	5-3
Verify the SCAN RATE function	5-3
Verify the LOCAL function	5-4
Verify the SAVE and RECALL functions	5-4
Verify the event timer	5-5
If the verification check fails	5-6
Verifying the Agilent 11896A Specifications	5-7
Insertion loss	5-7
Return loss	5-8
How to Return the Agilent 11896A for Service	5-9
Packaging	5-9
Instrument shipping preparation procedure	5-10
Sales and service offices	5-12
Sales and service offices	5-12
Service Information	5-14
General information	5-14
Serial-number information	5-14
Safety considerations	5-14
Reliability considerations	5-15
Protection from electrostatic discharge	5-15
Required service tools	5-16
Adjustment procedure	5-16
Replacement procedures	5-17
To replace the front-panel assembly	5-17
To replace the polarization assembly	5-18
To replace the power supply	5-18
To replace the GPIB connector	5-18
Replaceable parts	5-19
Replaceable parts table format	5-19
Part ordering information	5-19
Direct mail-order system	5-20
Direct phone-order system	5-20

Regular orders	5-20
Hotline orders	5-20
A. Choosing the Scan Rate and Measurement Time	
Single wavelength PDL measurements	A-2
Swept wavelength PDL measurements	A-3
Depolarization application	A-4
B. Measurement Considerations	
Overall insertion loss	B-2
Insertion loss variation with paddle position	B-3
Optical return loss	B-3
Extinction ratio	B-4
Paddle angle repeatability	B-5
Settling time	B-5
Paddle rotation rates	B-5
Nominal quarter-wave plates	B-5

Index

Figures

1-1. Typical application setup using the Agilent 11896A polarization controller.	1-3
1-2. Setup for single-wavelength PDL measurements using an optical power meter.	1-5
1-3. Setup for swept-wavelength PDL measurements using an optical spectrum analyzer.	1-6
1-4. Example of swept-wavelength PDL test data.	1-7
1-5. Setup for single-wavelength max/min PDL measurements.	1-8
1-6. Example of max/min PDL measurement data.	1-9
1-7. Agilent 11896A polarization controller block diagram.	1-10
1-8. Example of a static-safe work station.	1-16
2-1. Checking the fuse.	2-5
5-1. Agilent 11896A assembly level replaceable parts.	5-21
B-1. Block diagram for testing the extinction ratio of the Agilent 11896A.	B-4

Tables

1-1. Performance Specifications	1-12
1-2. Static-Safe Accessories	1-17
2-1. Accessories Supplied with the Agilent 11896A	2-3
2-2. Agilent 11896A Power Requirements	2-4
2-3. AC Power Cables Available	2-7
4-1. Standard Event Status Enable Register	4-20
4-2. Standard Event Status Register	4-21
4-3. Service Request Enable Register	4-24
4-4. Status Byte Register	4-25
4-5. Error Messages	4-33
5-1. Agilent Technologies Service Numbers	5-13
5-2. Required Tools	5-16
5-3. Assembly-Level Replaceable Parts	5-21
A-1. Selecting Averaging Time, Scan Rate and Measurement Time	A-3

Contents



General Information

General Information

What you'll find in this chapter

- A description of the Agilent 11896A polarization controller.
- A list of options and accessories available.
- Agilent 11896A polarization controller specifications and characteristics.
- Information about the controller's serial number label.
- Information about avoiding damage to the controller from electrostatic discharge.

Description

The Agilent 11896A polarization controller provides manual and automatic polarization state adjustments over a wide wavelength range (1250 to 1600 nm). All possible states of polarization are achieved with extremely small optical insertion-loss variations (± 0.002 dB). This performance combination maximizes measurement accuracy for power sensitive measurements such as polarization-dependent loss, gain and optical/electrical responsivity because the measurement uncertainty contributed by the polarization controller is minimized. A typical application configuration using the polarization controller is shown in Figure 1-1.

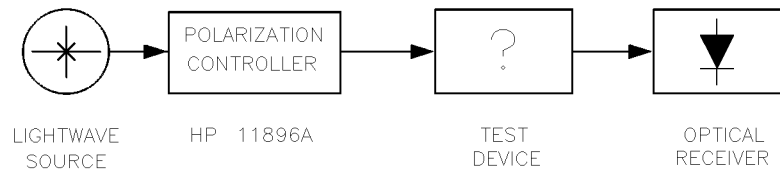

Figure 1-1. Typical application setup using the Agilent 11896A polarization controller.

Description

Instrument configuration

The standard Agilent 11896A polarization controller includes:

- FC/PC front-panel connector interfaces
- *Agilent 11896A User, Programming, and Service Guide*

Options

The following options are available:

Option	Description
Option 010	Deletes FC/PC front-panel connector interfaces.
Option 025	One meter pigtail fiber with FC/PC connector interfaces.

Accessories

The *Fiber Optics Handbook* (Agilent part number 5952-9654) is an introduction to, and a reference for, fiber-optic measurements.

Polarization-dependent loss measurements

Polarization-dependent loss (PDL) measurement systems can be created by combining the Agilent 11896A with instruments like the Agilent 8153A lightwave multimeter, the Agilent 71450A or Agilent 71451A optical spectrum analyzer and the Agilent 8509A/B lightwave polarization analyzer.

Power meter PDL
measurement system

Figure 1-2 shows how to configure the Agilent 11896A polarization controller and the Agilent 8153A optical power meter for performing automatic single-wavelength PDL measurements. Measurement repeatability of a few thousandths of a dB can typically be achieved.

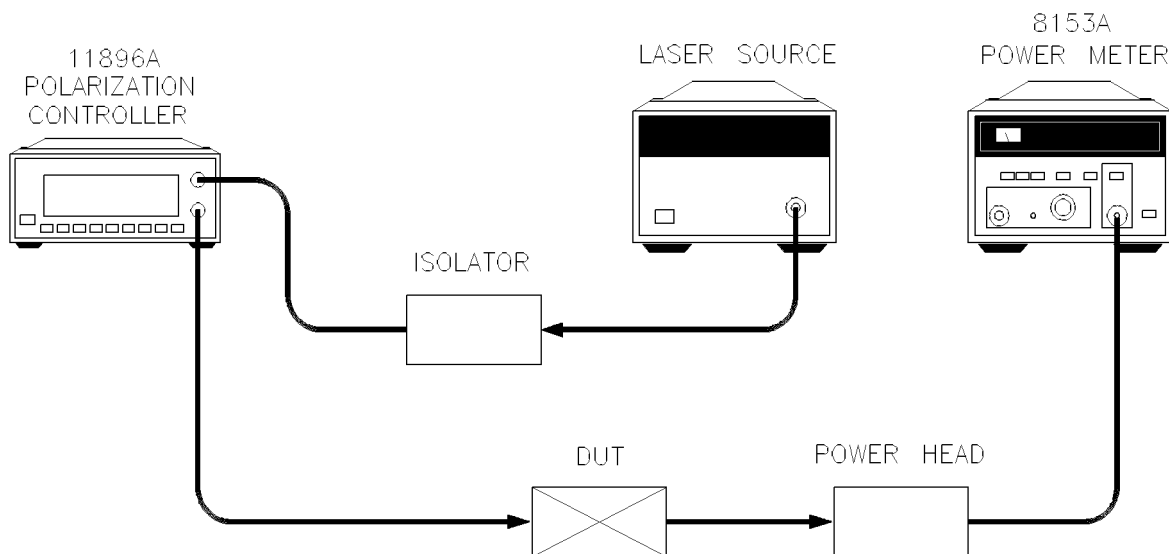

Figure 1-2. Setup for single-wavelength PDL measurements using an optical power meter.

General Information

Description

Swept-wavelength PDL
measurement system

Figure 1-3 shows how to configure the Agilent 11896A polarization controller and the Agilent 71451A optical spectrum analyzer for performing automatic swept-wavelength PDL measurements.

Figure SWPTWAVE here.

Figure 1-3. Setup for swept-wavelength PDL measurements using an optical spectrum analyzer.

Description

Max/min PDL
measurement system

Figure 1-5 shows how to setup the Agilent 11896A polarization controller and the Agilent 8509A/B lightwave polarization analyzer for performing automatic single-wavelength max/min PDL measurements.

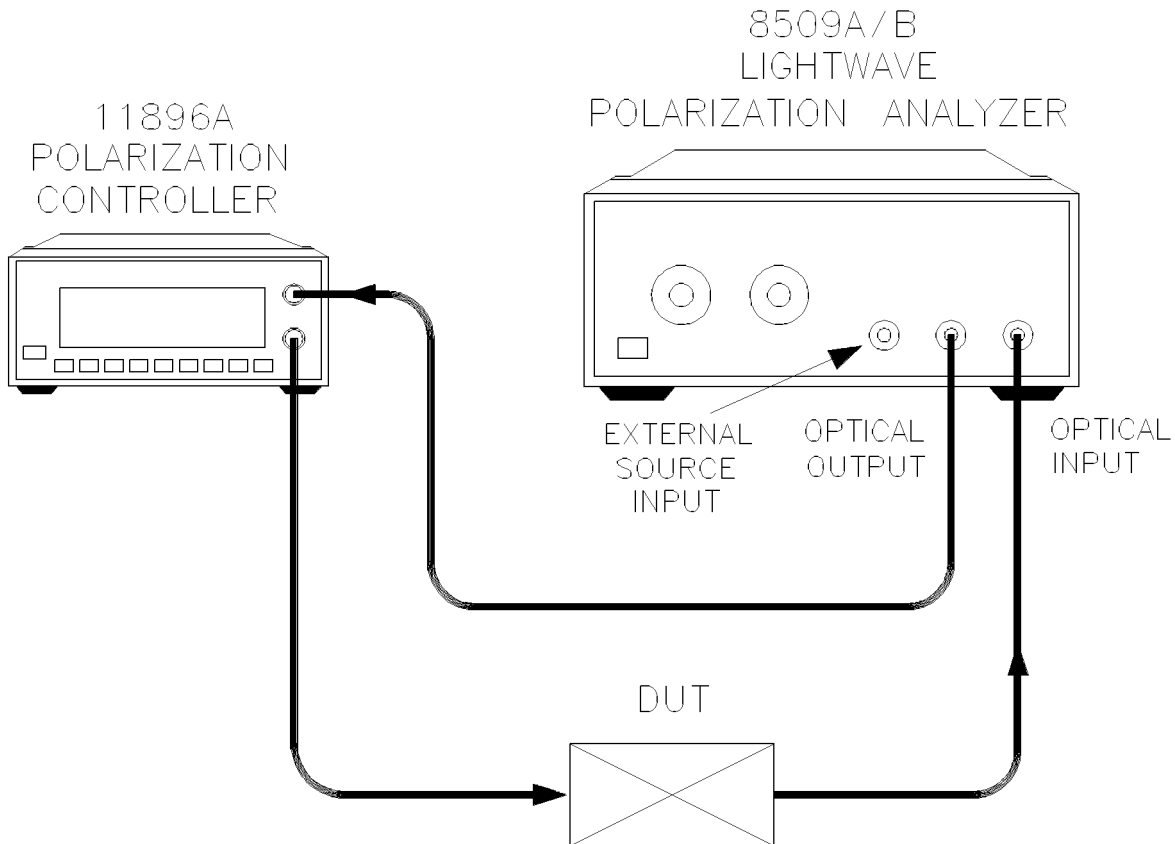
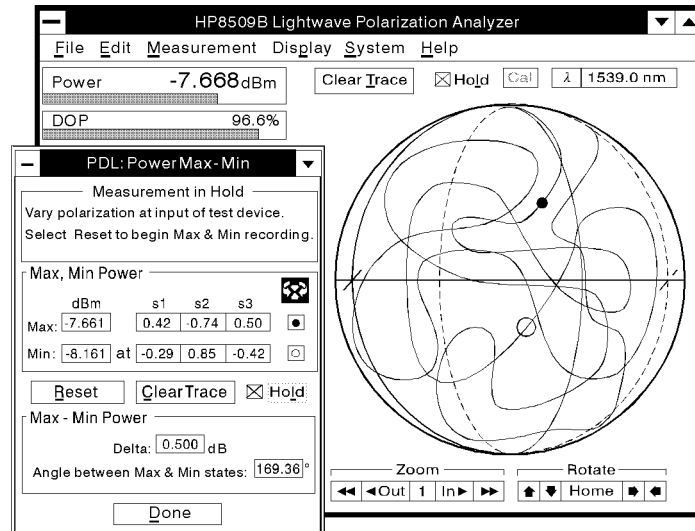

Figure 1-5. Setup for single-wavelength max/min PDL measurements.

An example of max/min PDL measurement data is shown in Figure 1-6. The states of polarization are displayed as Stokes parameters and PDL markers on the Poincare sphere at the points where maximum and minimum power values actually occur during the measurement.



pq775b_c

Figure 1-6. Example of max/min PDL measurement data.

Theory of Operation

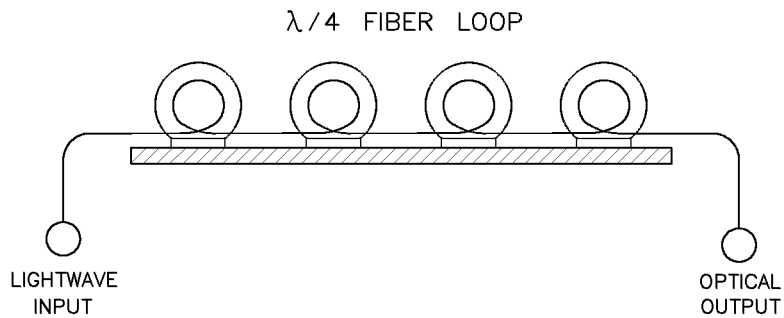

Figure 1-7. Agilent 11896A polarization controller block diagram.

The transmitted signal enters the polarization controller and passes through the internal four-fiber-loop assembly. The dimensions of each loop are optimized to approximate a quarter-wave retarder response over the polarization controller's specified wavelength range. Complete and continuous polarization adjustability is achieved by independently adjusting each loop over an angular range of 180° . This range is divided into 1000 equal steps (000–999), providing an adjustment resolution of 0.18° . Adjustments can be made manually, using the front-panel knobs, or automatically, using remote GPIB commands or the built-in autoscanning control and the SAVE and RECALL registers.

Specifications and Characteristics

This section contains specifications and characteristics for the Agilent 11896A polarization controller. The specifications in this chapter apply over the temperature range 0 °C to +55 °C (unless otherwise noted). All specifications apply after the instrument's temperature has been stabilized after 1 hour continuous operation and self-calibration routines have been run. Fiber pigtail interfaces are assumed for all cases, except where otherwise stated.

- Specifications** *Specifications* describe warranted performance.
- Characteristics** *Characteristics* provide useful, but nonwarranted, information about the functions and performance of the instrument. *Characteristics are printed in italics.*
- Calibration cycle** Agilent Technologies warrants instrument specifications over the recommended calibration interval. To maintain specifications, periodic recalibrations are necessary. We recommend that the Agilent 11896A polarization controller be calibrated at an Agilent Technologies service facility every 24 months.

Specifications and Characteristics**Table 1-1. Performance Specifications**

Performance Specifications	Standard (FC/PC connectors)¹	Option 025 (fiber pigtails)
Operating wavelength range	1250 to 1600 nm	1250 to 1600 nm
Insertion loss		
Overall insertion loss	<2.0 dB ²	<1.5 dB ³
Variation with paddle position	<±0.02 dB ²	<±0.002 dB ³
Variation with wavelength 1250-1600 nm	≤±0.3 dB	≤±0.3 dB
Variation with wavelength any 100 nm range	≤±0.1 dB	≤±0.1 dB
Optical return loss	35 dB ²	55 dB ³
Polarization extinction ratio	>40 dB ⁴	>40 dB ⁴
Paddle adjustment		
Paddle angle resolution	0.18° ⁵	0.18° ⁵
Paddle angular repeatability	0.18° ⁵	0.18° ⁵
Settling time	<1 sec	<1 sec
Number of scan rates	8	8
Maximum paddle rotation rate	360°/sec	360°/sec
Number of SAVE/RECALL memory registers	9	9
Maximum allowable input power	+23 dBm	+23 dBm
Operating Specifications		
Operating temperature	0° C to 55° C	
Non-operating, storage temperature	-40° C to +70° C	
Humidity	15% to 95%, non-condensing	
Power requirements	47 to 63 Hz 90 to 264 Vrms	
Power consumption	60 VA max	
Physical Specifications		
Weight	4.5 kg 10 lb	
Dimensions (H × W × D)	10 × 21.3 × 36 cm 3.9 × 8.4 × 14.2 in	

¹ Also applies to Option 010 when using FC/PC connectors.

² Characteristic, non-warranted performance.

³ When the Agilent 11896A is spliced into the measurement system.

⁴ Extinction ratio refers only to the polarized portion of the optical signal.

⁵ Any position.

DECLARATION OF CONFORMITY

according to ISO/IEC Guide 22 and EN 45014

Manufacturer's Name: Hewlett-Packard Co.

Manufacturer's Address: 1400 Fountaingrove Parkway
Santa Rosa, CA 95403-1799
USA

declares that the product:

Product Name: Polarization State Controller

Model Number: HP 11896A

Product Options: This declaration covers all options of the above product.

conforms to the following Product specifications:

Safety: IEC 1010-1:1990+A1 / EN 61010-1:1993
CAN/CSA-C22.2 No. 1010.1-92

EMC: CISPR 11:1990/EN 55011:1991 Group 1, Class A
IEC 801-2:1984/EN 50082-1:1992 4 kV CD, 8 kV AD
IEC 801-3:1984/EN 50082-1:1992 3 V/m, 27-500 MHz
IEC 801-4:1988/EN 50082-1:1992 0.5 kV Sig. Lines, 1 kV Power Lines
IEC 1000-3-2:1995 / EN 61000-3-2:1995
IEC 1000-3-3:1994 / EN 61000-3-3:1994

Supplementary Information:

This product herewith complies with the requirements of the Low Voltage Directive 73/23/EEC and the EMC Directive 89/336/EEC and carries the CE-marking accordingly.

Santa Rosa, California, USA 26 Dec. 1996

John Hiatt/Quality Engineering Manager

European Contact: Your local Hewlett-Packard Sales and Service Office or Hewlett-Packard GmbH, Department ZQ/Standards
Europe, Herrenberger Strasse 130, D-71034 Böblingen, Germany (FAX: +49-7031-14-3143)

Serial Numbers

Agilent Technologies makes frequent improvements to its products to enhance their performance, usability, or reliability, and to control costs. Agilent Technologies service personnel have access to complete records of design changes to each type of equipment, based on the equipment's serial number. Whenever you contact Agilent Technologies about your polarization controller, have the complete serial number available to ensure obtaining the most complete and accurate information possible. A serial-number label is attached to the rear of the polarization controller. It contains the serial number and the options installed in the polarization controller. The serial number has two parts: the prefix (the first four numbers and a letter), and the suffix (the last five numbers). Whenever you refer to the serial number when using it to obtain information about your controller, be sure to use the complete number, including the full prefix and suffix.

Electrostatic Discharge Information

Electrostatic discharge (ESD) can damage or destroy electronic components. All work on electronic assemblies should be performed at a static-safe work station. Figure 1-8 shows an example of a static-safe work station using two types of ESD protection:

- Conductive table-mat and wrist-strap combination.
- Conductive floor-mat and heel-strap combination.

Both types, when used together, provide a significant level of ESD protection. Of the two, only the table-mat and wrist-strap combination provides adequate ESD protection when used alone. To ensure user safety, the static-safe accessories must provide at least 1 M Ω of isolation from ground.

WARNING

These techniques for a static-safe work station should not be used when working on circuitry with a voltage potential greater than 500 volts.

Electrostatic Discharge Information

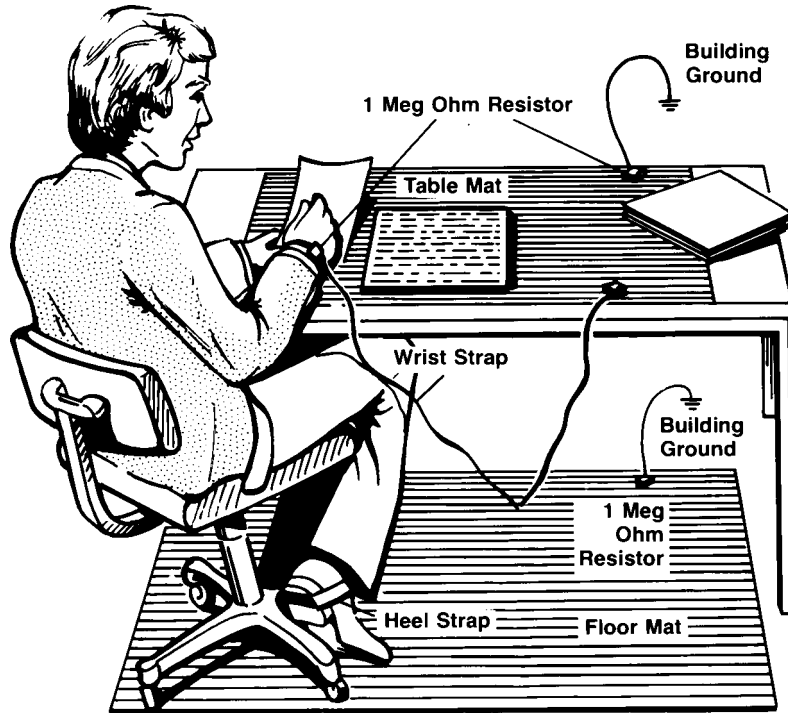

Figure 1-8. Example of a static-safe work station.

Reducing ESD damage

The following suggestions may help reduce ESD damage that occurs during testing and servicing operations.

- Before connecting any coaxial cable to an instrument connector for the first time each day, momentarily ground the center and outer conductors of the cable.
- Personnel should be grounded with a resistor-isolated wrist strap before touching the center pin of any connector and before removing any assembly from the unit.
- Be sure that all instruments are properly earth-grounded to prevent a buildup of static charge.

Table 1-2 lists static-safe accessories that can be obtained from Agilent Technologies using the Agilent part numbers shown.

Table 1-2. Static-Safe Accessories

Agilent Part Number	Description
9300-0797	Set includes: 3M static control mat 0.6 m × 1.2 m [2 ft× 4 ft] and 4.6 cm [15 ft] ground wire. [The wrist-strap and wrist-strap cord are not included. They must be ordered separately.]
9300-0980	Wrist-strap cord 1.5 m [5 ft].
9300-1383	Wrist-strap, color black, stainless steel, without cord, has four adjustable links and a 7 mm post-type connection.
9300-1169	ESD heel-strap [reusable 6 to 12 months].

General Information

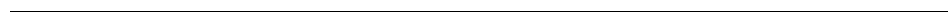

Installation and Preparation for Use

Installation and Preparation for Use

What you'll find in this chapter

- Preparing the polarization controller for use.
- Turning on the controller.
- Making fiber optic connections.

Preparing the Polarization Controller for Use

Initial inspection

Inspect the Agilent 11896A shipping container for damage. If the shipping container or cushioning material is damaged, keep it until you have verified that the contents are complete and you have tested the polarization controller mechanically and electrically. Table 2-1 lists the accessories shipped with the polarization controller.

Notify the carrier if:

- the contents are incomplete or if the polarization controller does not pass the verification test (this procedure is provided in “Performing a Verification Check” in Chapter 5).
- the shipping container is damaged or the cushioning material shows signs of stress.

Keep the shipping materials for the carrier’s inspection. The Agilent Technologies office will arrange for repair or replacement without waiting for a claim settlement. If the shipping materials are in good condition, retain them for possible future use. You may wish to ship the polarization controller to another location or return it to Agilent Technologies for service. Refer to “How to Return the Agilent 11896A for Service” in Chapter 5.

Table 2-1. Accessories Supplied with the Agilent 11896A

Description	Agilent Part Number	Comments
Power cable	See Table 2-3	Shipped with the polarization controller.
Operating and service manual	11896-90001	Shipped with the polarization controller.

Preparing the Polarization Controller for Use

Connecting the Agilent 11896A to a power source

The polarization controller is a portable instrument and requires no physical installation other than connection to a power source.

CAUTION

Do not connect ac power until you have verified that the line voltage is correct and the proper fuse is installed. Damage to the equipment could result.

Power requirements

Table 2-2. Agilent 11896A Power Requirements

Characteristic	Requirement
Input Voltage	90 to 264 Vrms
Frequency	47 to 63 Hz
Power	60 VA [maximum]

Checking the fuse

The recommended fuse is a 2 A, 250 V, Agilent part number 2110-0710. The line fuse is housed in a small container in the line module (refer to Figure 2-1). The spare fuse is stored below the line fuse. To check the fuse, insert the tip of a screwdriver between the instrument and the side of the container. Gently pull outward to remove the container. If the fuse is defective or missing, install a new fuse in the proper position and reinsert the fuse container.

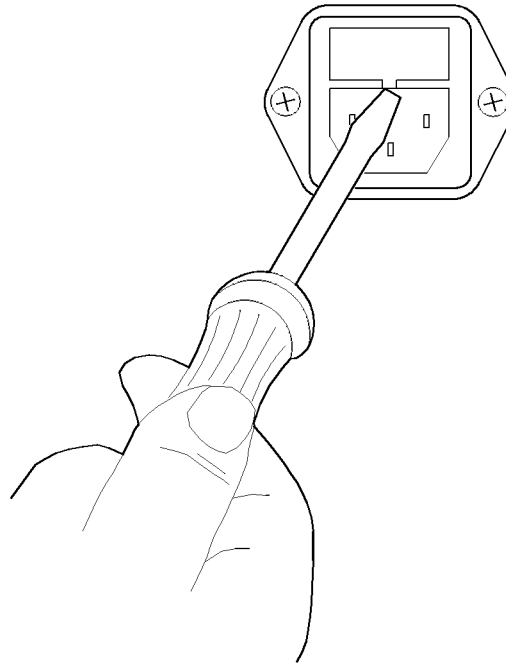

Figure 2-1. Checking the fuse.

Power cable

The polarization controller is equipped with a three-wire power cable, in accordance with international safety standards. When connected to an appropriate power line outlet, this cable grounds the instrument cabinet.

Preparing the Polarization Controller for Use





WARNING

Failure to ground the polarization controller properly can result in personal injury. Before turning on the polarization controller, you must connect its protective earth terminals to the protective conductor of the main power cable. Insert the main power cable plug only into a socket outlet that has a protective earth contact. DO NOT defeat the earth-grounding protection by using an extension cable, power cable, or autotransformer without a protective ground conductor. If you are using an autotransformer, make sure its common terminal is connected to the protective earth contact of the power source outlet socket.

Various power cables are available to connect the polarization controller to the types of ac power outlets unique to specific geographic areas. The cable appropriate for the area to which the polarization controller is originally shipped is included with the unit. You can order additional ac power cables for use in different areas. Table 2-3 lists the available ac power cables, illustrates the plug configurations, and identifies the geographic area in which each cable is appropriate.

Installation and Preparation for Use
Preparing the Polarization Controller for Use

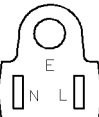
Table 2-3. AC Power Cables Available

PLUG TYPE **	CABLE HP PART NUMBER	PLUG DESCRIPTION	CABLE LENGTH CM (INCHES)	CABLE COLOR	FOR USE IN COUNTRY
250V 	8120-1351 8120-1703	Straight* BS1363A 90°	229 (90) 229 (90)	Mint Gray Mint Gray	Great Britain, Cyprus, Nigeria, Singapore, Zimbabwe
250V 	8120-1369 8120-0696	Straight* NZSS198/ASC112 90°	201 (79) 221 (87)	Gray Gray	Argentina, Australia, New Zealand, Mainland China
250V 	8120-1689 8120-1692	Straight* CEE7-Y11 90°	201 (79) 201 (79)	Mint Gray Mint Gray	East and West Europe, Central African Republic, United Arab Republic (unpolarized in many nations)
125V 	8120-1348 8120-1538	Straight* NEMA5-15P 90°	203 (80) 203 (80)	Black Black	United States Canada, Japan (100 V or 200 V), Brazil, Colombia, Mexico, Philippines, Saudia Arabia, Taiwan
	8120-1378 8120-4753 8120-1521 8120-4754	Straight* NEMA5-15P Straight 90° 90°	203 (80) 230 (90) 203 (80) 230 (90)	Jade Gray Jade Gray Jade Gray Jade Gray	
250V 	8120-5182 8120-5181	Straight* NEMA5-15P 90°	200 (78) 200 (78)	Jade Gray Jade Gray	Israel
<p>* Part number for plug is industry identifier for plug only. Number shown for cable is HP Part Number for complete cable, including plug.</p> <p>** E = Earth Ground; L = Line; N = Neutral.</p>					

Turning on the Agilent 11896A

With the power cable inserted into the line module, turn the polarization controller on by rocking the front-panel switch to the “1” position. After a moment, numerals appear on the front-panel LCD. If the LCD fails to light, refer to “Performing a Verification Check” in Chapter 5.

Lightwave Connector Care

Introduction

Lightwave cable interfaces can be damaged by improper cleaning and connection procedures. Dirty or damaged lightwave interfaces can result in nonrepeatable or inaccurate measurements. This section will suggest some best practices to clean, care for, connect, and inspect lightwave connectors.

Lightwave connectors are used to connect two fiber ends together. These connections may be used to join cables between optical ports on devices, laser sources, receivers, patch panels, terminals and many other types of systems or components.

Fiber optic cables are used at different wavelengths, in single or multi-mode, and in different environments. There are a variety of sizes, core/cladding combinations, jackets, and indexes of refraction. In general, different types of cables do not work well together. Cables should match each other and the system.

However, regardless of the cable type, the connectors have only one function: to provide a direct and low-loss optical signal transition from one fiber end to another. When these connectors are used in a measurement system, repeatability becomes an important factor.

Lightwave connectors differ from electrical or microwave system connectors. In a fiber optic system, light is transmitted through an extremely small fiber core. Because fiber cores are often 62.5 microns (0.0625 mm) or less in diameter, and dust particles range from tenths of a micron to several microns in diameter, dust and very minute contamination on the end of the fiber core can degrade the performance of the connector interface (where the two cores meet). Therefore, the connector must be precisely aligned and the connector interface free of trapped foreign material.

Connector (or insertion) loss is one important performance characteristic of a lightwave connector. Typical values are less than 1 dB of loss, and sometimes as little as 0.1 dB of loss with high performance connectors.

Lightwave Connector Care

Return loss is another important factor. It is a measure of reflection: the less reflection the better (the larger the return loss, the smaller the reflection). The best physically contacting connectors have return losses better than 40 dB, although 20 to 30 dB is more common.

Causes of connector loss and reflections include core misalignment, differences in the numerical aperture of two fibers, spacing and air gaps, reflections caused by damaged, worn, or loose fiber ends, and the improper use and removal of index matching compounds.

Achieving the best possible connection, where the fiber end faces are flush (no air gap) and properly aligned, depends on two things:

1. the type of connector.
2. using the proper cleaning and connecting techniques. If the connection is lossy or reflective, light will not make a smooth transition. If the transition is not smooth or the connection is not repeatable, measurement data will be less accurate. For this reason, lightwave connections can make a critical difference in optical measurement systems.

Cleaning and handling

Proper cleaning and handling of lightwave connectors is imperative for achieving accurate and repeatable measurements with your Agilent Technologies lightwave equipment. Lightwave interfaces should be cleaned before each measurement using the techniques described in this handbook. Information on protecting and storing your connectors/cables and tips on how to properly mate connectors are also included in this section.

Definition of terms

To avoid confusion, the following definitions are used in this handbook.

- Connector** Houses the fiber end, most open at the end of a lightwave cable or on the front panel of an instrument or accessory.
- Adapter** Does not contain optical fiber. Used to mate two optical connectors.

Handling

Always handle lightwave connectors and cable ends with great care. Fiber ends should never be allowed to touch anything except other mating surfaces or cleaning solutions and tools.

Always keep connectors and cable ends covered with a protective cap when they are not in use. (See "Storage.")

Cleaning

Three cleaning processes are provided. The first process describes how to clean non-lensed lightwave connectors. The second process describes how to clean lightwave adapters. The third process describes how to care for lensed lightwave connections.

CAUTION

Agilent Technologies strongly recommends that index matching compounds NOT be applied to their Instruments and accessories. Some compounds, such as gels, may be difficult to remove and can contain damaging particulates. If you think the use of such compounds is necessary, refer to the compound manufacturer for information on application and cleaning procedures.

Cleaning non-lensed lightwave connectors

Equipment

The following is a list of the items that should be used to clean non-lensed lightwave connectors.

- Any commercially available denatured alcohol
- Cotton swabs Agilent part number 8520-0023
- Compressed air Agilent part number 8500-5262

CAUTION

Agilent Technologies recommends that you do not use any type of foam swab to clean optical fiber ends. Foam swabs can leave filmy deposits on fiber ends that can degrade performance.

Process

Before cleaning the fiber end, clean the ferrules and other parts of the connector. Use isopropyl alcohol, clean cotton swabs, and clean compressed air. Then use alcohol to clean the fiber end. Some amount of wiping or mild scrubbing of the fiber end can help remove particles when application of alcohol alone will not remove them. This can be done by applying the alcohol to a cotton swab and moving it back and forth across the fiber end several times. This technique can help remove or displace particles smaller than one micron.

Allow the connector to dry (about a minute) or dry it immediately with clean compressed air. Compressed air lessens the chance of deposits remaining on the fiber end after the alcohol evaporates. It should be blown horizontally across the fiber end. Visually inspect the fiber end for stray cotton fibers. As soon as the connector is dry, the connection should be made.

CAUTION

Inverting the compressed air canister while spraying will produce residue on the sprayed surface. Refer to instructions provided on the compressed air canister.

Cleaning lightwave adapters

Equipment

All of the items listed above for cleaning connectors may be used to clean lightwave adapters. In addition, small foam swabs may be used along with isopropyl alcohol and compressed air to clean the inside of lightwave connector adapters.

NOTE

As noted in a previous caution statement, the foam swabs can leave filmy deposits. These deposits are very thin however, and the risk of other contamination buildup on the inside of adapters greatly outweighs the risk of contamination of foam swab deposits left from cleaning the inside of adapters.

Process

Clean the adapter by applying isopropyl alcohol to the inside of the connector with a foam swab. Allow the adapter to air dry, or dry it immediately with clean compressed air.

Cleaning lensed connections

Some instruments may have a connector that is “lensed.” In other words, the connection does not provide a physically contacting connection, but the light is received into a lens rather than into a connecting fiber. These receiving lenses usually have an anti-reflective coating that is very easily damaged. Therefore, these connectors should NEVER have cleaning solutions or any other substance applied to them unless it is specifically recommended by the manufacturer. You may wish to use clean compressed air to rid them of dust from time to time.

Lightwave Connector Care

Storage

All of Agilent Technologies' lightwave instruments are shipped with either laser shutter caps or dust caps on the lightwave adapters that come with the instrument. Also, all of the cables that are shipped have covers to protect the cable ends from damage or contamination. These dust caps and protective covers should be kept on the equipment at all times except when in use.

The adapters that were shipped on your instrument can be removed from the connectors on the instrument. If you remove these adapters you should keep the exposed connector of your instrument covered until the next use. Protective covers for these exposed connectors are not provided with the instruments, so it is best to keep the adapters on the instrument with the dust covers on.

The list below provides the Agilent part numbers for the laser shutter cap and dust caps that are provided with lightwave instruments and accessories.

Item	Agilent Part No.	Connector Option
Laser shutter cap	08145-64521	All options
FC/PC dust cap	08154-44102	opt 012
Biconic dust cap	08154-44105	opt 015
DIN dust cap	5040-9364	opt 013
HMS 10 dust cap	5040-9361	opt 011
ST dust cap	5040-9366	opt 014
SC dust cap	1401-0253	opt 017

Making connections

Proper connection technique requires attention to connector compatibility, insertion technique and torque requirements. Connectors must be the same connector type in order to ensure mechanical and optical compatibility. Attempting to connect incompatible connector types may prevent the connection from functioning properly and even cause damage to the fiber surfaces. A visual inspection of the mechanical interfaces may not be enough because some connector types have the same mechanical interface but have different optical fiber interfaces (for example, angled-no-contact, angled-contact or straight-contact fiber interfaces). Refer to the manufacturer's data sheet to confirm connector type compatibility before connecting.

When you insert the ferrule into a connector or adapter, make sure that the fiber end does not touch the outside of the mating connector or adapter. In this way, you will not rub the fiber end against any undesirable surface. Many connectors have a keyed slot provided for optimum measurement repeatability that also helps to align and seat the two connectors. After the ferrule is properly seated inside the other connector, use one hand to keep it straight, rotate it to align the key, and tighten it with the other hand.

Most connectors using springs to push fiber ends together exert one to two pounds of force. Over-tightening or under-tightening these connectors can result in misalignment and nonrepeatable measurements. Always finger tighten the connector in a consistent manner. Refer to the manufacturer's data sheet for any torque recommendations.

Summary

When making measurements with lightwave instruments or accessories, the following precautions will help to insure good, reliable, repeatable measurements:

- Confirm connector type compatibility.
- Use extreme care in handling all lightwave cables and connectors.
- Be sure the connector interfaces are clean before making any connections.
- Use the cleaning methods described in this handbook.
- Keep connectors and cable ends covered when not in use.

Inspection

Visual inspection

Although it is not necessary, visual inspection of fiber ends can be helpful. Contamination and/or imperfections on the cable endface can be detected as well as cracks or chips in the fiber itself.

Several fiber inspection scopes are on the market, but any microscope with an enlargement range of 100× to 200× can be used. It is helpful to devise some method to hold the fiber in place while viewing in this range.

Inspect the entire endface for contamination, raised metal, or dents in the metal, as well as any other imperfections. Inspect the fiber core for cracks and chips.

Visible imperfections not touching the fiber core may not affect the performance of the lightwave connection (unless the imperfections keep the fibers from contacting). Consistent optical measurements are the best assurance that your lightwave connection is performing properly.

Optical performance testing

Introduction Consistent measurements with your lightwave equipment are a good indication that you have good connections. However, you may wish to know the insertion loss and/or return loss of your lightwave cables or accessories. If you test your cables and accessories for insertion loss and return loss upon receipt, and retain the measured data for comparison, you will be able to tell in the future if any degradation has occurred.

Insertion loss Insertion loss can be tested using a number of different test equipment configurations. Some of these are:

- an Agilent 8702 or Agilent 8703 lightwave component analyzer system with the lightwave source and receivers
- an Agilent 83420 lightwave test set with an Agilent 8510 network analyzer, an Agilent 8153 lightwave multimeter with source and power sensor modules

Many other possibilities exist. The basic requirements are an appropriate lightwave source and a compatible lightwave receiver. Refer to the manuals provided with your lightwave test equipment for information on how to perform an insertion loss test.

As mentioned earlier in this handbook, typical insertion loss for cables is less than 1 dB, and can be as little as 0.1 dB. For actual specifications on your particular cable or accessory, refer to the manufacturer.

Installation and Preparation for Use

Return loss

Return loss can be tested using a number of different test equipment configurations. Some of these are:

- an Agilent 8703 lightwave component analyzer
- an Agilent 8702 analyzer with the appropriate source, receiver and lightwave coupler
- an Agilent 8504 precision reflectometer
- an Agilent 8153 lightwave multimeter with an Agilent 81543 return loss module

Many other possibilities exist. The basic requirements are an appropriate lightwave source, a compatible lightwave receiver, and a compatible lightwave coupler.

Refer to the manuals provided with your lightwave test equipment for information on how to perform a return loss test.

As mentioned earlier in this handbook, typical return loss is better than 20 to 30 dB, and can be better than 40 dB. For actual specifications on your particular cable or accessory, refer to the manufacturer.

Using the Agilent 11896A Polarization Controller

Using the Agilent 11896A Polarization Controller

What you'll find in this chapter

- Agilent 11896A series front-panel features.
- Agilent 11896A series rear-panel features.
- Instructions for manually operating the polarization controller.

Front-Panel Features

The front panel of the polarization controller includes three main sections:

- Polarization adjustment
- Instrument state
- Data entry

Using the Agilent 11896A
Polarization Controller
Front-Panel Features

The front panel includes a display and four knobs for adjusting the paddles. The right-most knob is also used to adjust the scan rate, the SAVE and RECALL register numbers, and the GPIB address when using the front-panel function keys.

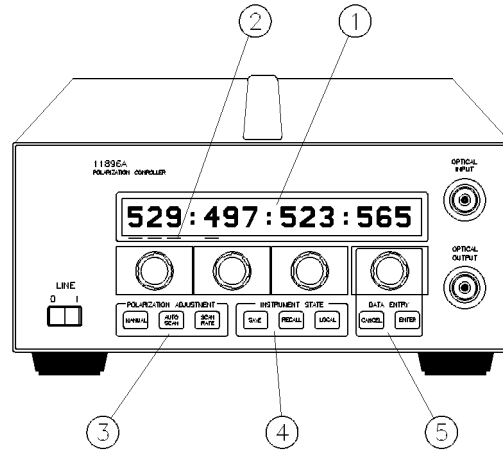

The Agilent 11896A front panel.

- 1 Display screen. Used to display paddle positions and instrument settings.
- 2 Status indicators. Indicates the current status of the RMT, LSN, TLK, and SRC lines.
- 3 Polarization adjustment keys. Includes the **MANUAL**, **AUTO SCAN**, and **SCAN RATE** keys.
- 4 Instrument state keys. Includes the **SAVE**, **RECALL**, and **LOCAL** keys.
- 5 Data entry keys. Includes the **CANCEL** and **ENTER** keys.

Error codes

The controller has six error codes that can appear on the front panel twelve digit 7-segment LED display:

Error Message Type of Error

MOTOR ERROR Error parking the motor. Indicates a stuck paddle, faulty motor and so forth.

SCPI ERR Execution problem occurred in the SCPI controller such as the memory or a CPU register is corrupted. This message is displayed for 12 seconds and then the instrument will attempt to reboot.

The following errors can be displayed if an error is detected when the instrument is initially turned on.

SCPI E1
SCPI E2
Error 1
HAP E1

If any of these errors are displayed on the screen, the instrument may require service. Refer to Chapter 5 for information.

Rear-Panel Features

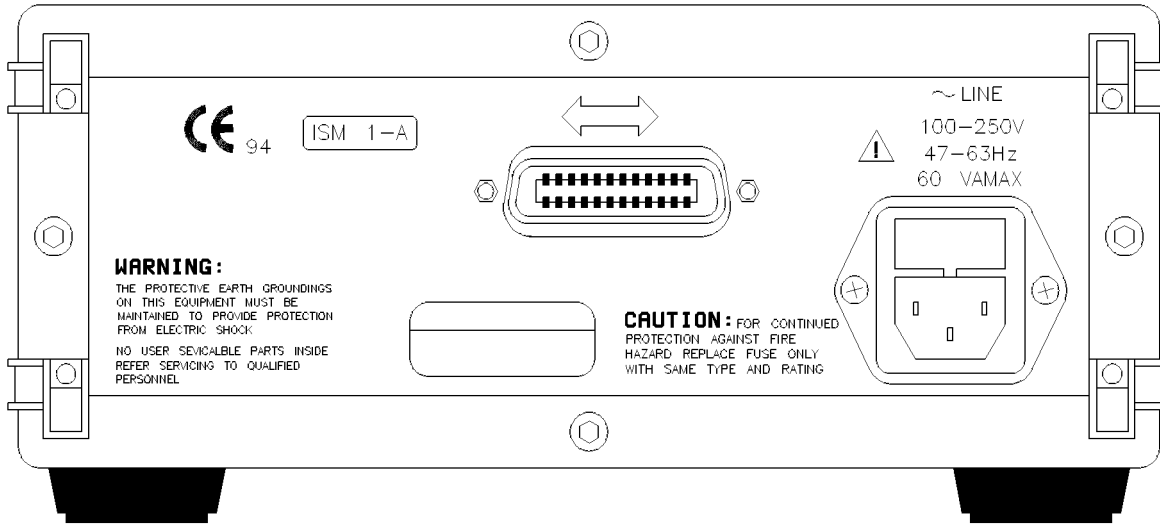

The Agilent 11896A rear panel.

- 1 Power input
- 2 GPIB connector

Using the Agilent 11896A

Precise manual adjustment of the four paddles in the polarization controller can be made using the front-panel knobs while watching the display. Each paddle can rotate 180° in 1000 discrete steps of 0.18° each. The three-segment display shows the relative step count, where zero corresponds to 0° and 999 corresponds to 180° .

Nine save/recall registers enable rapid state of polarization hopping between nine different user-set states of polarization (SOP). Autoscanning continuously sweeps all states of polarization in a random fashion, eliminating the need to manually tune the SOP across the entire Poincare sphere. Eight polarization scan rates are available to match the speed of the application, whether it is a five-minute, wavelength-scanning PDL measurement or a three-second, single-wavelength PDL measurement. Autoscanning rates are fast enough to produce polarization scrambling for some applications.

Remote interrogation of all instrument settings and remote control of all instrument functions are provided via GPIB. Refer to Chapter 4 for information on remote programming.

Power-up function

The power switch is located in the lower left-hand corner of the front panel. Turn the polarization controller on by setting the switch to the “1” position. When the polarization controller is turned on:

- All display segments are lit for approximately one second.
- The firmware revision number is displayed for approximately one second.
- All four paddles are set to the middle position (500).
- The SAVE and RECALL registers, the SCAN RATE, and the GPIB address contain the same values they had when the power was last turned off.

To use the Manual mode

To control the paddles from the front panel, press **MANUAL**.

- Each of the four paddles can now be controlled by its respective knob.
- Paddle positions are displayed where; “000” corresponds to 0°, and “999” corresponds to 180°.

To continuously sweep all polarization states

To continuously and randomly sweep all polarization states, press **AUTOSCAN**.

- The scan time clock is reset to 00:00. This indicates the present scan time has been active 0 minutes, 0 seconds.
- Polarization scanning is initiated at the current scan rate.
- The elapsed scan time in minutes and seconds is displayed, along with the current scan rate.

To set the scan rate

To change the scan rate, press, **SCAN RATE**.

- The current scan rate is displayed.
- Adjust the scan rate using the right-most knob.
- To select and lock-in the displayed scan rate, press **ENTER**.

NOTE

The scan rate returns to the previous value if any key is pressed *prior* to pressing **ENTER**.

To save an instrument state

To save the instrument state, press **(SAVE)**.

- The number of the last Save register used is displayed.
- Use the right-most knob to select the desired register (1-9).
- To save the current instrument state in the displayed register, press **(ENTER)**.

The following instrument parameters are saved:

- instrument state (scan or manual)
- paddle positions
- scan rate

To recall an instrument state

To recall a previously saved instrument state, press **(RECALL)**.

- The number of the last Save register used is displayed.
- Use the right-most knob to select the desired register (1-9).
- To recall the instrument state of the displayed register, press **(ENTER)**.

The following instrument parameters are recalled:

- instrument state (scan or manual)
- paddle positions
- scan rate
- Recalling instrument state zero resets the polarization controller and sets all four paddles to the middle position (500).

To use the Local function

When the polarization controller is under remote GPIB control, enable local control by pressing **LOCAL**.

To display or change the GPIB address

To display or change the GPIB address, press **LOCAL**.

- The current GPIB address is displayed.
- Use the right-most knob to select the desired address (1-30).
- To save the currently displayed address, press **ENTER**.

Using the Agilent 11896A
Polarization Controller
Using the Agilent 11896A

Programming

Programming

What you'll find in this section

This section introduces the basics for remote programming of a polarization controller. The programming instructions in this manual conform to the IEEE 488.2 Standard Digital Interface for Programmable Instrumentation. The programming instructions provide the means of remote control.

You can perform the following basic operations with a computer and a polarization controller:

- Set up the instrument.
- Make measurements.
- Get data (measurements, configuration) from the polarization controller.
- Send information (configurations) to the polarization controller.

Other tasks are accomplished by combining these basic functions.

Changing the GPIB address

The polarization controller's default (factory set) primary address is 20.

NOTE

The programming examples for individual commands in this manual are written in HP BASIC 5.0 for an HP 9000 Series 200/300 Controller.

Talking to the Instrument

Computers acting as controllers communicate with the instrument by sending and receiving messages over a remote interface. Instructions for programming normally appear as ASCII character strings embedded inside the output statements of a "host" language available on your controller. The input statements of the host language are used to read in responses from the polarization controller.

For example, HP 9000 Series 200/300 BASIC uses the OUTPUT statement for sending commands and queries. After a query is sent, the response is usually read in using the ENTER statement.

Messages are placed on the bus using an output command and passing the device address, program message, and terminator. Passing the device address ensures that the program message is sent to the correct interface and instrument.

The following HP BASIC statement sends a command which sets the paddle 1 position to 50.

```
OUTPUT < device address > ;":PADD1:POSITION 50"<terminator>
```

The < device address > represents the address of the device being programmed. Each of the other parts of the above statement are explained in the following pages.

Program Message Syntax

To program the instrument remotely, you must have an understanding of the command format and structure expected by the instrument. The IEEE 488.2 syntax rules govern how individual elements such as headers, separators, program data, and terminators may be grouped together to form complete instructions. Syntax definitions are also given to show how query responses are formatted.

Output command

The output command is entirely dependent on the programming language. Throughout this manual HP 9000 Series 200/300 BASIC 5.0 is used in the examples of individual commands. If you are using other languages, you will need to find the equivalents of HP BASIC commands like OUTPUT, ENTER, and CLEAR in order to convert the examples. The instructions listed in this manual are always shown between quotes in the example programs.

Device address

The location where the device address must be specified is also dependent on the programming language you are using. In some languages, this may be specified outside the output command. In HP BASIC, this is always specified after the keyword OUTPUT. The examples in this manual assume the polarization controller is at device address 720. When writing programs, the address varies according to how the bus is configured.

Instructions

Instructions (both commands and queries) normally appear as a string embedded in a statement of your host language, such as BASIC, Pascal, or C.

Instructions are composed of two main parts:

- The header, which specifies the command or query to be sent.
- The program data, which provide additional information needed to clarify the meaning of the instruction.

Instruction header

The instruction header is one or more mnemonics separated by colons (:) that represent the operation to be performed by the instrument.

Queries are indicated by adding a question mark (?) to the end of the header. Many instructions can be used as either commands or queries, depending on whether or not you have included the question mark. The command and query forms of an instruction usually have different program data. Many queries do not use any program data.

White space (separator)

White space is used to separate the instruction header from the program data. If the instruction does not require any program data parameters, you do not need to include any white space. In this manual, white space is defined as one or more spaces. ASCII defines a space to be character 32 (in decimal).

Program data

Program data are used to clarify the meaning of the command or query. They provide necessary information, such as whether a function should be on or off. Each instruction's syntax definition shows the program data, as well as the values they accept. The section "Program Data Syntax Rules" in this chapter has all of the general rules about acceptable values.

When there is more than one data parameter, they are separated by commas (.). Spaces can be added around the commas to improve readability.

Header types

There are three types of headers:

- Simple Command headers.
- Compound Command headers.
- Common Command headers.

Simple command header

Simple command headers contain a single mnemonic. INITIATE and ABORT are examples of simple command headers typically used in this instrument. The syntax is:

`<program mnemonic><terminator>`

Program Message Syntax

Compound command header

Compound command headers are a combination of two program mnemonics. The first mnemonic selects the subsystem, and the second mnemonic selects the function within that subsystem. The mnemonics within the compound message are separated by colons. For example:

To execute a single function within a subsystem:

```
:<subsystem>:<function><separator><program data><terminator>
```

(For example :PADD1:POSITION 50)

Common command header

Common command headers control IEEE 488.2 functions within the instrument (such as clear status). Their syntax is:

```
*<command header><terminator>
```

No space or separator is allowed between the asterisk (*) and the command header. *CLS is an example of a common command header.

Combining commands

To execute more than one function within the same subsystem a semi-colon (;) is used to separate the functions:

```
:<subsystem>:<function><separator><data>;<function><separator><data><terminator>
```

(For example :SCAN:RATE 5;TIMER:CLEAR)

Duplicate mnemonics

Identical function mnemonics can be used for more than one subsystem. For example, the function mnemonic `STATus` may be used to set bits in either the status operation register or the status questionable register.

- To set the lower four bits of the enable register for the status operation register (the enable register is a bit mask for the status operation register), use:

```
:STATus:OPER:ENABLe 15
```

- To set the fifth bit of the enable register for the status questionable register, use:

```
:STATus:QUES:ENABLe 16
```

`OPER` and `QUES` are subsystem selectors and determine which status register, the operation or the questionable, the command will affect.

Query command

Command headers immediately followed by a question mark (?) are queries. After receiving a query, the instrument interrogates the requested function and places the answer in its output queue. The answer remains in the output queue until it is read or another command is issued. When read, the answer is transmitted across the bus to the designated listener (typically a controller). For example, the query :SCAN:RATE? places the current scan rate setting in the output queue. In HP BASIC, the controller input statement:

```
ENTER < device address > ;Rate
```

passes the value across the bus to the controller and places it in the variable Rate.

Query commands are used to find out how the instrument is currently configured. They are also used to get results of measurements made by the instrument. For example, the command :SCAN:TIMER? instructs the instrument to report the amount of time elapsed in seconds since scanning was initiated.

The output queue must be read before the next program message is sent. For example, when you send the query :SCAN:TIMER?, you must follow that query with an input statement. In HP BASIC, this is usually done with an ENTER statement immediately followed by a variable name. This statement reads the result of the query and places the result in a specified variable.

NOTE

Sending another command or query before reading the result of a query causes the output buffer to be cleared and the current response to be lost. This also generates a query interrupted error in the error queue.

Program header options

Program headers can be sent using any combination of uppercase or lowercase ASCII characters. Instrument responses, however, are always returned in uppercase.

Program command and query headers may be sent in either long form (complete spelling), short form (abbreviated spelling), or any combination of long form and short form.

`:PADDLE1:POSITION 50` - long form

`:PADD1:POS 50` - short form

Programs written in long form are easily read and are almost self-documenting. The short form syntax conserves the amount of controller memory needed for program storage and reduces the amount of I/O activity.

Program data syntax rules

Program data is used to convey a variety of types of parameter information related to the command header. At least one space must separate the command header or query header from the program data.

`<program mnemonic><separator><data><terminator>`

Numeric program data

Some command headers require program data to be expressed numerically. For example, :PADD:POS requires the desired paddle position range to be expressed numerically.

For numeric program data, you have the option of using exponential notation or using suffix multipliers to indicate the numeric value. The following numbers are all equal:

$28 = 0.28E2 = 280e-1 = 28000m = 0.028K = 28e-3K$.

When a syntax definition specifies that a number is an integer, that means that the number should be whole. Any fractional part would be ignored, truncating the number. Numeric data parameters which accept fractional values are called real numbers.

All numbers are expected to be strings of ASCII characters. Thus, when sending the number 9, you would send a byte representing the ASCII code for the character "9" (which is 57). A three-digit number like 102 would take up three bytes (ASCII codes 49, 48, and 50). This is taken care of automatically when you include the entire instruction in a string.

Program message terminator

The program instructions within a data message are executed after the program message terminator is received. The terminator may be either an NL (New Line) character, an EOI (End-Of-Identify) asserted in the GPIB interface, or a combination of the two. Asserting the EOI sets the EOI control line low on the last byte of the data message. The NL character is an ASCII linefeed (decimal 10).

NOTE

The NL (New Line) terminator has the same function as an EOS (End Of String) and EOT (End Of Text) terminator.

Selecting multiple subsystems

You can send multiple program commands and program queries for different subsystems on the same line by separating each command with a semicolon. The colon following the semicolon enables you to enter a new subsystem. For example:

```
:<program mnemonic><data>;:<program mnemonic><data><terminator>  
:PADD1:POS 50; :SCAN:RATE 6
```

NOTE

Multiple commands may be any combination of compound and simple commands.

Initialization

To make sure the bus and all appropriate interfaces are in a known state, begin every program with an initialization statement. HP BASIC provides a CLEAR command which clears the interface buffer:

CLEAR 720 ! initializes the interface of the instrument

When you are using GPIB, CLEAR also resets the polarization controller's parser. The parser is the program which reads in the instructions which you send it.

After clearing the interface, initialize the instrument to a preset state:

OUTPUT 720; "*RST" ! initializes the instrument to a preset state.

NOTE

Refer to your controller manual and programming language reference manual for information on initializing the interface.

Programming over GPIB

This section describes the GPIB interface functions and some general concepts. In general, these functions are defined by IEEE 488.2. They deal with general interface management issues, as well as messages which can be sent over the interface as interface commands.

Interface capabilities

The interface capabilities of the polarization controller as defined by IEEE 488.1, are SH1, AH1, T5, L4, SR1, RL1, PP1, DC1, DT1, C0, and E2.

Command and data concepts

The interface has two modes of operation:

- command mode.
- data mode.

The bus is in the command mode when the ATN line is true. The command mode is used to send talk and listen addresses and various bus commands, such as a group execute trigger (GET).

The bus is in the data mode when the ATN line is false. The data mode is used to convey device-dependent messages across the bus.

Addressing

To allow the instrument to go into remote mode when sent a GPIB command, send the command:

```
''REMOTE 7''
```

To place the instrument in remote mode, send the command:

```
''REMOTE 720''
```

NOTE

There is no way to place the instrument in remote mode from the front-panel.

- Each device on the GPIB resides at a particular address, 0-30.
- The active controller specifies which devices talk and which listen.
- An instrument may be talk addressed, listen addressed, or unaddressed by the controller.

If the controller addresses the instrument to talk, the instrument remains configured to talk until it receives an interface clear message (IFC), another instrument's talk address (OTA), its own listen address (MLA), or a universal untalk command (UNT).

If the controller addresses the instrument to listen, the instrument remains configured to listen until it receives an interface clear message (IFC), its own talk address (MTA), or a universal unlisten command (UNL).

Communicating over the bus (HP 9000 series 200/300 controller)

Since GPIB can address multiple devices through the same interface card, the device address passed with the program message must include not only the correct interface select code, but also the correct instrument address.

Interface select code
(selects interface)

Each interface card has a unique interface select code. This code is used by the controller to direct commands and communications to the proper interface. The default is typically "7" for GPIB controllers.

Instrument address
(selects instrument)

Each instrument on a GPIB must have a unique instrument address between decimal 0 and 30. The device address passed with the program message must include not only the correct instrument address, but also the correct interface select code.

DEVICE ADDRESS = (Interface Select Code * 100) + (Instrument Address)

For example, if the instrument address for the polarization controller is 4 and the interface select code is 7, when the program message is passed, the routine performs its function on the instrument at device address 704.

For the polarization controller, the instrument address is typically set to "20" at the factory. This address can be changed in the GPIB menu.

NOTE

The examples in this manual assume the polarization controller is at device address 720.

Lockout

To disable front-panel control while a program is running, send the LOCAL LOCKOUT command.

The instrument can be returned to local mode by sending the LOCAL command to the instrument.

NOTE

Cycling the power also restores front-panel control.

Bus commands

The following commands are IEEE 488.2 bus commands (ATN true). IEEE 488.2 defines many of the actions which are taken when these commands are received by the instrument.

- | | |
|-----------------|--|
| Device clear | The device clear (DCL) or selected device clear (SDC) commands clear the input and output buffers, reset the parser, and clear any pending commands. |
| Interface clear | The interface clear (IFC) command halts all bus activity. This includes unaddressing all listeners and the talker, disabling serial poll on all devices, and returning control to the system controller. |

Common commands

*CLS (Clear Status)

The *CLS (clear status) common command clears the status data structures, including the device-defined error queue. This command also clears the Request-for-OPC flag.

If the *CLS command immediately follows a program message terminator, the output queue and the MAV (message available) bit are cleared.

Command Syntax: *CLS

Example: OUTPUT 720;”*CLS”

Common Commands

*ESE
(Event Status Enable)

The *ESE command sets the bits in the Standard Event Status Enable Register. The Standard Event Status Enable Register contains a mask value for the bits to be enabled in the Standard Event Status Register. A one in the Standard Event Status Enable Register enables the corresponding bit in the Standard Event Status Register. A zero disables the bit. Refer to Table 4-1 for information about the Standard Event Status Enable Register bits, bit weights, and what each bit masks.

The *ESE query returns the current contents of the register.

Command Syntax: *ESE <mask>	
Where:	<mask> ::= 0 to 255
Example: ¹	OUTPUT 720; **ESE 64"
Query Syntax: *ESE?	
Returned Format:	<mask><NL>
Where:	<mask> ::= 0 to 255 [integer-NR1 format]
Example:	OUTPUT 720; **ESE?" ENTER 720;Event PRINT Event

¹ In this example, the *ESE 64 command enables URQ (user request) bit 6 of the Standard Event Status Enable Register. Therefore, when a front panel key is pressed, the ESB (event summary bit) in the Status Byte Register is also set.

Table 4-1. Standard Event Status Enable Register

Enables Standard Event Status Enable Register (High-Enables the ERS bit)		
Bit	Weight	Enables
7	128	PON - Power On
6	64	URQ - User Request
5	32	CME - Command Error
4	16	EXE - Execution Error
3	8	DDE - Device Dependent Error
2	4	QYE - Query Error
1	2	TRG - Trigger Query
0	1	OPC - Operation Complete

*ESR
(Event Status Register)

The *ESR query returns the contents of the Standard Event Status Register.

When you read the Event Status Register, the value returned is the total bit weights of all of the bits that are high at the time you read the byte. Table 4-2 shows each bit in the Event Status Register and its bit weight.

Reading the register clears the Event Status Register.

```

Query Syntax:      *ESR?
Returned Format:    <status><NL>
Where:              <status> ::= 0 to 255 [integer-NR1 format]
Example:            OUTPUT 720;*"ESR?"
                   ENTER 720;Event
                   PRINT Event
    
```

Table 4-2. Standard Event Status Register

Bit	Bit Weight	Bit Name	Condition
7	128	PON	0 = no power-on detected 1 = power-on detected
6	64	URQ	0 = no front-panel key has been pressed 1 = a front-panel key has been pressed
5	32	CME	0 = no command errors 1 = a command error has been detected
4	16	EXE	0 = no execution error 1 = an execution error has been detected
3	8	DDE	0 = no device dependent errors 1 = a device dependent error has been detected
2	4	QYE	0 = no query errors 1 = a query error has been detected
1	2	TRG	0 = no trigger or AUTO [autolevel] 1 = trigger [can be 1 only in Normal, Single, TV trigger modes]
0	1	OPC	0 = operation is not complete 1 = operation is complete
			0 = False = Low 1 = True = High

Common Commands

*IDN
(Identification Number)

The *IDN query identifies the instrument type and software version by returning the following string:

```
"HEWLETT-PACKARD 11896A 0 <X.X>"
```

Where:

<X.X> ::= the software revision of the instrument.

An *IDN query must be the last query in a message. Any queries after the *IDN query in a program message are ignored.

Query Syntax:	*IDN?
Returned Format:	HEWLETT-PACKARD,11896A,0,X,X<NL>
Example:	DIM Id\$(50) OUTPUT 720;"*IDN?" ENTER 720;Id\$ PRINT Id\$

*OPC
(Operation Complete)

The *OPC (operation complete) command sets the operation complete bit in the Standard Event Status Register when all pending device operations have finished.

The *OPC query places an ASCII "1" in the output queue when all pending device operations have finished.

Command Syntax:	*OPC
Example:	OUTPUT 720;"*OPC"
Query Syntax:	*OPC?
Returned Format:	1<NL>
Example:	OUTPUT 720;":PADD1:POS 100;*OPC?" ENTER 720;Op\$

*RCL (Recall)

The *RCL command restores the state of the instrument from the specified save/recall register. An instrument setup must have been stored previously in the specified register. *RCL 0 has the same effect as *RST.

Command Syntax: *RCL { 0 | 1 | 2 | 3 | 4 | 5 | 6 | 7 | 8 | 9 }

Example: OUTPUT 720; **RCL 3"

*RST (Reset)

The *RST command places the instrument in a known state. The instrument is placed in manual mode and all paddles are set to position 500. The scan rate and instrument status registers are not affected.

Command Syntax: *RST

Example: OUTPUT 720; **RST"

*SAV (Save)

The *SAV command stores the current state of the device in a save register. The data parameter is the number of the save register where the data will be saved. Registers 1 through 9 are valid for this command.

Command Syntax: *SAV { 1 | 2 | 3 | 4 | 5 | 6 | 7 | 8 | 9 }

Example: OUTPUT 720; **SAV 3"

Common Commands

*SRE
(Service Request Enable)

The *SRE command sets the bits in the Service Request Enable Register. The Service Request Enable Register contains a mask value for the bits to be enabled in the Status Byte Register. A one in the Service Request Enable Register enables the corresponding bit in the Status Byte Register. A zero disables the bit. Table 4-3 lists the bits in the Service Request Enable Register and what they mask.

The *SRE query returns the current value.

Command Syntax: *SRE <mask>	
Where:	<mask> ::= 0 to 255
Example:	OUTPUT 720;>**SRE 32"
Query Syntax: *SRE?	
Returned Format:	<mask><NL>
Where:	<mask> ::= sum of all bits that are set, 0 through 255 [integer-NR1 format]
Example:	OUTPUT 720;>**SRE?" ENTER 720;Value PRINT Value

Table 4-3. Service Request Enable Register

Service Request Enable Register (High - Enables the SRE bit)		
Bit	Weight	Enables
7	128	Not Used
6	64	RQS - Request Service
5	32	ESB - Event Status Bit
4	16	MAV - Message Available
3	8	not used
2	4	not used
1	2	instrument is scanning
0	1	paddles moving in manual mode

*STB (Status Byte)

The *STB query returns the current value of the instrument's status byte. The MSS (Master Summary Status) bit is reported on bit 6 instead of the RQS (request service) bit. The MSS indicates whether or not the device has at least one reason for requesting service. Refer to Table 4-4 for the meaning of the bits in the status byte.

To read the instrument's status byte with RQS reported on bit 6, use the interface Serial Poll.

Query Syntax:	*STB?
Returned Format:	<value><NL>
Where:	<value> ::= 0 through 255 [integer-NR1]
Example:	OUTPUT 720; "*STB?" ENTER 720; Value PRINT Value

Table 4-4. Status Byte Register

Bit	Bit/Weight	Bit/Name	Condition
7	128	—	0 = not used.
6	64	RQS/MSS	0 = instrument has no reason for service 1 = instrument is requesting service
5	32	ESB	0 = no event status conditions have occurred 1 = an enabled event status condition has occurred
4	16	MAV	0 = no output messages are ready 1 = an output message is ready
3	8	—	0 = not used
2	4	—	0 = not used
1	2	—	0 = instrument is in manual mode 1 = instrument is scanning
0	1	—	0 = paddles not moving in manual mode 1 = paddles moving in manual mode
			0 = false = low 1 = true = high

Common Commands

*TST (Test)

The *TST query performs a self-test on the instrument. The result of the test is placed in the output queue.

A zero indicates the test passed and a non-zero value indicates the test failed.

If a test fails, refer to the troubleshooting section of the polarization controller service manual.

Query Syntax:	*TST?
Returned Format:	<result><NL>
Where:	<result> ::= 0 or non-zero value
Where:	0 indicates the test passed non-zero indicates the test failed
Example:	OUTPUT 720; "**TST?" ENTER 720; Result PRINT Result

*WAI (Wait)

The *WAI command causes the instrument to wait until the current command is completed before executing the next remote command.

Command Syntax:	*WAI
Example:	OUTPUT 720; "**WAI"

Instrument specific commands

:ABORt

The :ABORt command stops the scanning. The instrument is placed in manual mode and the scan time is set to zero.

The :INITiate:IMMediate command must be executed to restart the paddles scanning.

Command Syntax: :ABORt

Example: OUTPUT 720;":ABOR"

:INITiate:IMMediate

The :INITiate:IMMediate command starts the paddles scanning.

Command Syntax: :INITiate:IMMediate

Example: OUPUT 720;":INIT:IMM"

Instrument Specific Commands

:PADDle:POSition

The :PADDle:POSition command sets the positions of one of the paddles when the instrument is in manual mode. To insure the paddle has reached its final position, it is best to send either the *WAI or *OPC commands before issuing other commands. If the instrument is scanning, this command generates an error. The default is PADD1.

The :POSition query returns the position of a paddle.

Command Syntax: :PADDle<1 | 2 | 3 | 4>:POSition {MAXimum | MINimum | <value>}

Where: <value> ::= the position of the selected paddle

Example: OUTPUT 720;“.PADD:POS 15;”

OUTPUT 720;“.PADD:POS MAX;”

Query Syntax: :PADD<1 | 2 | 3 | 4>:POS? <MAXimum | MINimum>

Returned Format: <value><NL>

Where: <value> ::= the position of the selected paddle or the maximum or minimum allowable position

Example: OUTPUT 720;“.PADD3:POS?”
ENTER 720;Paddle3_pos
PRINT Paddle3_pos

:SCAN:RATE

The :SCAN:RATE command sets the scan rate of the paddles to one of eight possible values. Scan rate “1” is the slowest rate, scan rate “8” is the fastest scan rate. Setting the scan when the instrument is already scanning resets the scan timer.

The :SCAN:RATE query returns the current scan rate.

<p>Command Syntax: :SCAN:RATE {MAXimum MINimum <value>}</p> <p>Where: <value> ::= the desired scan rate.</p> <p>Example: OUTPUT 720;“:SCAN:RATE 4;”</p> <p style="padding-left: 40px;">OUTPUT 720;“:SCAN:RATE MAX;”</p>
<p>Query Syntax: :SCAN:RATE? <MAXimum MINimum></p> <p>Returned Format: <value><NL></p> <p>Where: <value> ::= the current scan rate or the maximum or minimum allowable range</p> <p>Example: OUTPUT 720;“:SCAN:RATE?”</p> <p style="padding-left: 40px;">ENTER 720; Scan_rate</p> <p style="padding-left: 40px;">PRINT Scan_rate</p>

:SCAN:TIMer

The :SCAN:TIMer query returns the value of the scan timer in seconds.

<p>Query Syntax: :SCAN:TIMer?</p> <p>Returned Format: <value> <NL></p> <p>Where: <value> ::= value of the scan timer exponential-NR3 format </p> <p>Example: OUTPUT 720; “:SCAN:TIM?”</p> <p style="padding-left: 40px;">ENTER 720; Timer_val</p> <p style="padding-left: 40px;">PRINT Timer_val</p>
--

Instrument Specific Commands

:SCAN:TIMer:CLEar

The :SCAN:TIMer:CLEar command resets the scan timer to zero. (The commands *RST, INITiate:IMMediate, ABORT, and SCAN:RATE also reset the scan timer to zero.)

Command Syntax:	:SCAN:TIMer:CLEar
Example:	OUTPUT 720; "SCAN:TIM:CLE;"

:STATus:OPERation
:CONDition

The :STATus:OPERation:CONDition query always returns zero for the Agilent 11896A. It is a required command for IEEE 488.2 and is implemented only for completeness.

Query Syntax:	:STATus:OPERation:CONDition?
Example:	OUTPUT 720; "STAT:OPER:COND?" ENTER 720; Result PRINT Result

:STATus:OPERation
:ENABle

The STATus:OPERation:ENABle command sets the status enable register.
The :STATus:OPERation:ENABle query returns a decimal value indicating the number of bits set in the status enable register.

Command Syntax:	:STATus:OPERation:ENABle <value>
Where:	<value> ::= 0 to 255
Example:	OUTPUT 720; "STAT:OPER:ENAB 4;"
Query Syntax:	:STATus:OPERation:ENABle?
Returned Format:	<value><NL>
Where:	<value> ::= 0 TO 255 [integer-NR1 format]
Example:	OUTPUT 720; "STAT:OPER:ENAB?" ENTER 720; Operation_enable PRINT Operation_enable

:STATus:OPERation
:EVENT

The :STATus:OPERation:EVENT query always returns zero for the Agilent 11896A. It is a required command for IEEE 488.2 and is implemented only for completeness.

Query Syntax:	:STATus:OPERation:EVENT?
Example:	OUTPUT 720;“:STAT:OPER:EVENT?” ENTER 720;Result PRINT Result

:STATus:PRESet

The :STATus:PRESet command presets the SCPI transition filters, the SCPI enable registers, and the SCPI error/event queue enable. The SCPI event registers, the IEEE 488.2 status byte, and the standard event status are *not* affected.

Command Syntax:	:STATus:PRESet
Example:	OUTPUT 720;“:STAT:PRES;”

:STATus:QUESTionable
:CONDition

The :STATus:QUESTionable:CONDition query always returns zero for the Agilent 11896A. It is a required command for IEEE 488.2 and is implemented only for completeness.

Query Syntax:	:STATus:QUESTionable:CONDition?
Example:	OUTPUT 720;“:STAT:QUES:COND?” ENTER 720;Result PRINT Result

Instrument Specific Commands

:STATus:QUESTionable
:ENABle

The :STATus:QUESTionable:ENABle command sets the questionable data enable register.

The :STATus:QUESTionable:ENABle query returns a decimal value indicating the bits set in the questionable data enable register.

Command Syntax:	:STATus:QUESTionable:ENABle <value>
Where:	<value> ::= 0 to 255
Example:	OUTPUT 720; "STAT:QUES:ENAB 4;"
Query Syntax:	:STATus:QUESTionable:ENABle?
Returned Format:	<value><NL>
Where:	<value> ::= 0 TO 255 [integer-NR1 format]
Example:	OUTPUT 720; "STAT:QUES:ENAB?" ENTER 720; Status_enable PRINT Status_enable

:STATus:QUESTionable
:EVENT

The :STATus:QUESTionable:EVENT query always returns zero for the Agilent 11896A. It is a required command for IEEE 488.2 and is implemented only for completeness.

Query Syntax:	:STATus:QUESTionable:EVENT?
Example:	OUTPUT 720; "STAT:QUES:EVENT?" ENTER 720; Result PRINT Result

:SYSTem:ERRor

The :SYSTEM:ERROR query outputs the next error number in the error queue over the interface. This instrument has an error queue that is 30 errors deep and operates on a first-in, first-out basis. Repeatedly sending the query :SYSTEM:ERROR? returns the error numbers in the order they occurred until the queue is empty. Any further queries return zeros until another error occurs. If a string is used for the return variable, the error number and the error message will be returned.

Query Syntax: :SYSTem:ERRor?

Returned Format: <error><NL>

Where: <error> ::= an integer error code.

Example: OUTPUT 720;":SYSTEM:ERROR?"
 ENTER 720;Emsg
 PRINT Emsg

Table 4-5. Error Messages

Error Number	Description
-100	command error [unknown command]
-101	invalid character
-102	syntax error
-103	invalid separator
-104	data type error
-105	get not allowed
-108	parameter not allowed
-109	missing parameter
-112	program mnemonic too long
-113	undefined header
-400	query error
-410	query INTERRUPTED
-420	query UNTERMINATED
-430	query DEADLOCKED
-440	query UNTERMINATED after indefinite response

Programming

:SYSTem:VERSion

The :SYSTem:VERSion query returns the version of SCPI with which this instrument complies.

Query Syntax:	:SYSTem:VERSion?
Returned Format:	{version}<NL>
Example:	OUTPUT 720;":SYST:VERS?" ENTER 720;version PRINT version

Verification and Service Information

Verification and Service Information

What you'll find in this chapter

- How to perform a quick verification check of the Agilent 11896A lightwave polarization controller.
- How to verify the Agilent 11896A specifications.
- How to return the Agilent 11896A polarization controller for service.
- How to service the Agilent 11896A polarization controller.

Performing a Verification Check

To verify the functionality of the Agilent 11896A polarization controller, use the following procedure.

Verify startup

1. Turn on the polarization controller by setting the front-panel power switch to the "1" position.
2. Recall register zero (0) by pressing:

RECALL

Use the right-hand knob to select register zero (0) and then, press **ENTER**.

The display will initially read:

HP 11896A V1.00

(The number following V, is the firmware revision number. The number 1.0 is used as an example, your display may be different.)

Changing to:

500:500:500:500

Verify the SCAN RATE
function

3. Verify the Scan Rate function by pressing:

AUTO SCAN

SCAN RATE

Use the right-hand knob to set the scan rate to the "1" position.

Slowly increase the scan rate to "8". You will be able to hear a tone change, indicating a change in the paddle speed.

Performing a Verification Check

Verify the LOCAL function

4. Verify the Local function by pressing:

LOCAL

The display will read:

HPIB ADDR: 11

(The number 11 is used as an example, your display may be different.)

Turn the right-hand knob. The GPIB address on the display will change over a range of 00 to 30.

Verify the SAVE and
RECALL functions

5. Verify the Save and Recall functions by pressing:

RECALL

Adjust the right-hand knob until "0" is displayed.

6. Press **ENTER**.

The display will change to:

500:500:500:500

7. Save these values by pressing:

SAVE

Adjust the right-hand knob until "SAVE:1" is displayed.

8. Press **ENTER**.

The display will change to:

500:500:500:500

9. Use the front-panel knobs to set each paddle position at 510.

10. Save the new position settings by pressing:

SAVE

Adjust the right-hand knob until the display reads:

"SAVE:2"

11. Press **ENTER**.

12. Recall the position values in register 1 by pressing:

RECALL

Adjust the right-hand knob until "RECALL : 1" is displayed.

13. Press **ENTER**.

The display will change to:

500:500:500:500

14. Recall the position values in register 2 by pressing:

RECALL

Adjust the right-hand knob until the display reads:

"RECALL:2"

15. Press **ENTER**.

The display will change to:

510:510:510:510

Verify the
event timer

16. Select the Event Timer function by pressing:

AUTO/SCAN

The display will show a reading similar to:

00:01 SCAN5

The first half of the display is the event timer and will display the elapsed time of the scan, in a minute:second format.

The verification test is completed.

If the verification check fails

If the Agilent 11896A does not pass the verification check, you should review the procedure being performed when the problem occurred. A few minutes spent performing some simple checks may save waiting for your instrument to be repaired. Before calling Agilent Technologies or returning the unit for service, please make the following checks:

1. Is the line fuse good?
2. Does the line socket have power?
3. Is the unit plugged in to the proper ac power source?
4. Is the unit turned on?
5. If other equipment, cables, and connectors are being used with the Agilent 11896A, are they connected properly and operating correctly?
6. Review the procedure for the test being performed when the problem appeared. Are all the settings correct? Can the problem be reproduced?
7. Are the connectors clean? See “Cleaning and handling” in Chapter 2 for more information about cleaning the connectors.

If the Agilent 11896A still fails, you have two options:

- Return the lightwave polarization controller to Agilent Technologies for repair. If the lightwave polarization controller is still under warranty or is covered by an Agilent Technologies maintenance contract, it will be repaired under the terms of the warranty or contract. If the lightwave polarization controller is no longer under warranty or is not covered by an Agilent maintenance plan, Agilent Technologies will notify you of the cost of the repair after examining the unit. Refer to “How to Return the Agilent 11896A for Service” for more information.
- Have the unit repaired by qualified service personnel. Refer to “Service Information”.

Verifying the Agilent 11896A Specifications

To verify the specifications of the Agilent 11896A polarization controller, use the following procedures.

Insertion loss

Insertion loss can be tested using a number of different test equipment configurations. Some of these are:

- an Agilent 8702 or Agilent 8703 lightwave component analyzer system with the lightwave source and receivers
- an Agilent 83420 lightwave test set with an Agilent 8510 network analyzer, an Agilent 8153 lightwave multimeter with source and power sensor modules

Many other possibilities exist. The basic requirements are an appropriate lightwave source and a compatible lightwave receiver. Refer to the manuals provided with your lightwave test equipment for information on how to perform an insertion loss test.

As mentioned earlier in this handbook, typical insertion loss for cables is less than 1 dB, and can be as little as 0.1 dB. For actual specifications on your particular cable or accessory, refer to the manufacturer.

Verifying the Agilent 11896A Specifications

Return loss

Return loss can be tested using a number of different test equipment configurations. Some of these are:

- an Agilent 8703 lightwave component analyzer
- an Agilent 8702 analyzer with the appropriate source, receiver and lightwave coupler
- an Agilent 8504 precision reflectometer
- an Agilent 8153 lightwave multimeter with a source and power sensor module in conjunction with a lightwave coupler or an Agilent 81534 return loss module

Many other possibilities exist. The basic requirements are an appropriate lightwave source, a compatible lightwave receiver, and a compatible lightwave coupler.

Refer to the manuals provided with your lightwave test equipment for information on how to perform a return loss test.

As mentioned earlier in this handbook, typical return loss is better than 20 to 30 dB, and can be better than 40 dB. For actual specifications on your particular cable or accessory, refer to the manufacturer.

How to Return the Agilent 11896A for Service

When an instrument is returned to an Agilent Technologies service office for servicing, it must be adequately packaged and have a complete description of the failure symptoms attached.

When describing the failure, please be as specific as possible about the nature of the problem. Include copies of additional failure information (such as instrument failure settings, data related to instrument failure, and error messages) along with the instrument being returned.

Please notify the service office before returning your instrument for service. Any special arrangements for the instrument can be discussed at this time. This will help the Agilent Technologies service office repair and return your instrument as quickly as possible.

Packaging

The original shipping containers should be used. If the original materials were not retained, identical packaging materials are available through any Agilent Technologies office.

CAUTION

Instrument damage can result from using packaging materials other than the original materials. Never use styrene pellets as packaging material. They do not adequately cushion the instrument or prevent it from shifting in the carton. They may also cause instrument damage by generating static electricity.

Instrument shipping preparation procedure

1. Write a complete description of the failure and attach it to the instrument. Include any specific performance details related to the problem. The following information should be returned with the instrument.

- Type of service required.
- Date instrument was returned for repair.
- Description of the problem:
 - Whether problem is constant or intermittent.
 - Whether instrument is temperature-sensitive.
 - Whether instrument is vibration-sensitive.
 - Instrument settings required to reproduce the problem.
 - Error codes.
 - Performance data.
- Company name and return address.
- Name and phone number of technical contact person.
- Model number of returned instrument.
- Full serial number of returned instrument.
- List of any accessories returned with instrument.

2. Pack the instrument in the appropriate packaging material.

If the original or equivalent packaging materials cannot be obtained, instruments can be packaged using the following instructions.

CAUTION

Inappropriate packaging of instruments may result in damage to the instrument during transit.

- Wrap the instrument in antistatic plastic to reduce the possibility of damage caused by electrostatic discharge.
 - For instruments weighing less than 54 kg (120 lb), use a double-walled, corrugated cardboard carton of 159 kg (350 lb) test strength.
 - The carton must be large enough to allow 3 to 4 inches on all sides of the instrument for packing material, and strong enough to accommodate the weight of the instrument.
 - Surround the equipment with 3 to 4 inches of packing material, to protect the instrument and prevent it from moving in the carton. If packing foam is not available, the best alternative is S.D-240 Air Cap™ from Sealed Air Corporation (Commerce, California 90001). Air Cap looks like a plastic sheet filled with air bubbles. Use the pink (antistatic) Air Cap to reduce static electricity. Wrapping the instrument several times in this material will protect the instrument and prevent it from moving in the carton.
3. Seal the carton with strong nylon adhesive tape.
 4. Mark the carton “FRAGILE, HANDLE WITH CARE”.
 5. Retain copies of all shipping papers.

Sales and service offices

Sales and service offices

Agilent Technologies has sales and service offices located around the world to provide complete support for Agilent Technologies products. To obtain servicing information or to order replacement parts, contact the nearest Agilent Technologies Sales and Service Office. In any correspondence or telephone conversation, refer to the instrument by its model number, serial number, and option designation.

Before returning an instrument for service, call the Agilent Technologies Instrument Support Center at (800) 403-0801, visit the Test and Measurement Web Sites by Country page at <http://www.tm.agilent.com/tmo/country/English/index.html>, or call one of the numbers listed below.

Table 5-1. Agilent Technologies Service Numbers

Austria	01/25 125-7171
Belgium	32-2-778.37.71
Brazil	11 7297-8600
China	86 10 6261 3819
Denmark	45 99 12 88
Finland	358-10-855-2360
France	01.69.82.66.66
Germany	0180/524-6330
India	080-34 35788
Italy	+ 39 02 9212 2701
Ireland	01 615 8222
Japan	81 -426-56-7832
Korea	82/2-3770-0419
Mexico	5 258-4826
Netherlands	020-547 6463
Norway	22 73 57 59
Russia	+ 7-095-797-3930
Spain	34/91 631 1213
Sweden	08-5064 8700
Switzerland	01 735 7200
United Kingdom	01 344 366666
United States and Canada	800 403-0801

Service Information

What you'll find in this section

This section describes how to service the Agilent 11896A. It contains the following service information:

- General Information
- Adjustment Procedure
- Troubleshooting
- Replacement Procedures
- Replaceable Parts

General information

Serial-number information Whenever you contact Agilent Technologies about your lightwave polarization controller, have the complete serial number and option designation available. This will ensure you obtain accurate service information. Refer to “Serial Numbers” in Chapter 1 for more information.

Safety considerations Before servicing this lightwave polarization controller, familiarize yourself with the safety markings on the instrument and the safety instructions in this manual. This instrument has been manufactured and tested according to international safety standards. To ensure safe operation of the instrument and the personal safety of the user and service personnel, the cautions and warnings in this manual must be heeded.

Refer to the summary of safety considerations at the front of this manual. Individual chapters also contain detailed safety notation.

WARNING

Failure to ground the lightwave polarization controller properly can result in personal injury, as well as instrument damage.

Before turning on the lightwave polarization controller, connect a three-wire power cable with a standard IEC 320-C13 (CEE 22-V) inlet plug to the lightwave polarization controller power receptacle. The power cable outlet plug must be inserted into a power-line outlet socket that has a protective earth-contact. **DO NOT** defeat the earth-grounding protection by using an extension cable, power cable, or autotransformer without a protective ground conductor.

If you are using an autotransformer, make sure its common terminal is connected to the protective ground conductor of its power-source outlet socket.

Reliability considerations

The lightwave polarization controller input circuitry can be damaged by power levels that exceed the maximum safe input-level specifications. Refer to “Specifications and Characteristics” in Chapter 1 for the input specifications. To prevent input damage, these specified levels must not be exceeded.

Protection from electrostatic discharge

Electrostatic discharge (ESD) can damage or destroy electronic components. All work on electronic assemblies should be performed at a static-safe work station. Refer to “Electrostatic Discharge Information” in Chapter 1 for more information on preventing ESD.

Service Information

Required service tools

Table 5-2 lists the tools that may be required to service the Agilent 11896A.

Table 5-2. Required Tools

Description	Agilent Part Number
Small Pozidriv screwdriver	8710-0899
Large Pozidriv screwdriver	8710-0900
Wire cutter	8710-0012
Long-nose pliers	8710-0030
5/16-nut driver	8720-0015
3/8-nut driver	8720-0005
5.5 mm nut driver	8710-1220
7-mm nut driver	8710-1217
T-10 Torx driver	8710-1623
T-15 Torx driver	8710-1622
T-20 Torx driver	8710-1615
Description	Suhner PIN
Suhner connector removal tool	74Z-0-0-225

Adjustment procedure

The only adjustment for the Agilent 11896A is the +5.7 Vdc voltage supply. To adjust the power supply, use an Agilent 3456A digital multimeter (or equivalent) to measure the dc output voltage at the power supply terminals (red and black wires on connector). If the dc output voltage is not within tolerance (5.00 Vdc \pm 0.01 Vdc), adjust the power supply.

WARNING

Only trained service personnel should perform measurements inside the instrument chassis. Use extreme care; the exposed terminals on the power supply transformer carry ac line voltage; you can be killed or seriously injured if you contact them when power is applied.

Replacement procedures

This section describes procedures for replacing the assemblies in the Agilent 11896A polarization controller. To replace an assembly:

- Locate the desired assembly in Figure 5-1.
- Follow the steps for removing the desired assembly.
- Replace the assembly.
- Reassemble the polarization controller by reversing the procedure.

When replacing the polarization controller, center the optical connectors with the dress panel holes.

Refer to Figure 5-1 for the location of the assembly level replaceable parts.

Refer to Table 5-3 for a list of the part numbers of the replaceable assemblies and parts.

To replace the
front-panel assembly

1. Remove the machine screw on the rear of the handle.
2. Remove the top cover.
3. Gently unplug the three connectors attached to the polarization assembly. Take care not to bend the pins.
4. Remove the ribbon cable from the rear of the polarization assembly.
5. Remove the eight screws from the side panels, four on each side, using the small Torx driver.
6. Remove both side panels.
7. Cut the tie-wrap securing the cables to the side frame.
8. Remove the four screws from the front-panel assembly using the small Torx driver.
9. Remove the front-panel assembly.

Service Information

To replace the polarization assembly

1. Remove the front-panel assembly as described in “To replace the front-panel assembly”.
2. Gently unplug the power supply cable, line voltage cable, and ribbon cables (2) from the polarization assembly. Take care not to bend the pins.
3. Remove the polarization assembly by carefully sliding it up and towards the rear.

To replace the power supply

1. Remove the machine screw on the rear of the handle.
2. Remove the top cover.
3. Remove the four screws from the bottom panel using the small Torx driver.
4. Remove the bottom panel.
5. Gently unplug the cables and front panel connectors from the power supply assembly.
6. Remove the four screws securing the power supply assembly to the baseplate using the small Torx driver.

To replace the GPIB connector

1. Remove the machine screw on the rear of the handle.
2. Remove the top cover.
3. Remove the two screws securing the GPIB connector to the rear panel.
4. Remove the GPIB connector.

Replaceable parts

This section contains information for identifying and ordering replacement assemblies and mechanical parts for the Agilent 11896A lightwave polarization controller.

Replaceable parts
table format

Table 5-3 lists information for each major assembly and for each major mechanical and electrical part that is not part of a major assembly. The following information is listed in Table 5-3:

1. Agilent Technologies part number.
2. Description of the assembly.

Part ordering information

To order an assembly or mechanical part listed in this chapter, quote the Agilent Technologies part number and indicate the quantity required.

To order a part that is *not* listed, include the following information with the order:

- lightwave polarization controller model number.
- lightwave polarization controller serial number.
- Description of where the part is located, what it looks like, and its function (if known).
- Quantity needed.

Parts can be ordered by addressing the order to the nearest Agilent Technologies office. Customers within the USA can also use either the direct mail-order system or the direct phone-order system described below. The direct phone-order system has a toll-free phone number available.

Service Information

- Direct mail-order system Within the USA, Agilent Technologies can supply parts through a direct mail-order system. Advantages of using the system are as follows:
- Direct ordering and shipment from Agilent Technologies.
 - No maximum or minimum on any mail order. (There is a minimum order amount for parts ordered through a local Agilent office when the orders require billing and invoicing.)
 - Prepaid transportation. (There is a small handling charge for each order.)
 - No invoices.

To provide these advantages, a check or money order must accompany each order. Mail-order forms and specific ordering information are available through your local Agilent Technologies office.

- Direct phone-order system Within the USA, a phone order system is available for regular and hotline replacement parts service. A toll-free phone number is available, and Mastercard and Visa are accepted.

- Regular orders The toll-free phone number, (800) 227-8164, is available Monday through Friday, 6 am to 5 pm (Pacific time). Regular orders have a 4-day delivery time.

- Hotline orders Hotline service is available 24 hours a day, 365 days a year, for emergency parts ordering. The toll-free phone number, (800) 227-8164, is available Monday through Friday, 6 am to 5 pm (Pacific time). After-hours and on holidays, call (415) 968-2347.

To cover the cost of freight and special handling, there is an additional hotline charge on each order (three line items maximum per order). Hotline orders are normally delivered the next business day after they are ordered.

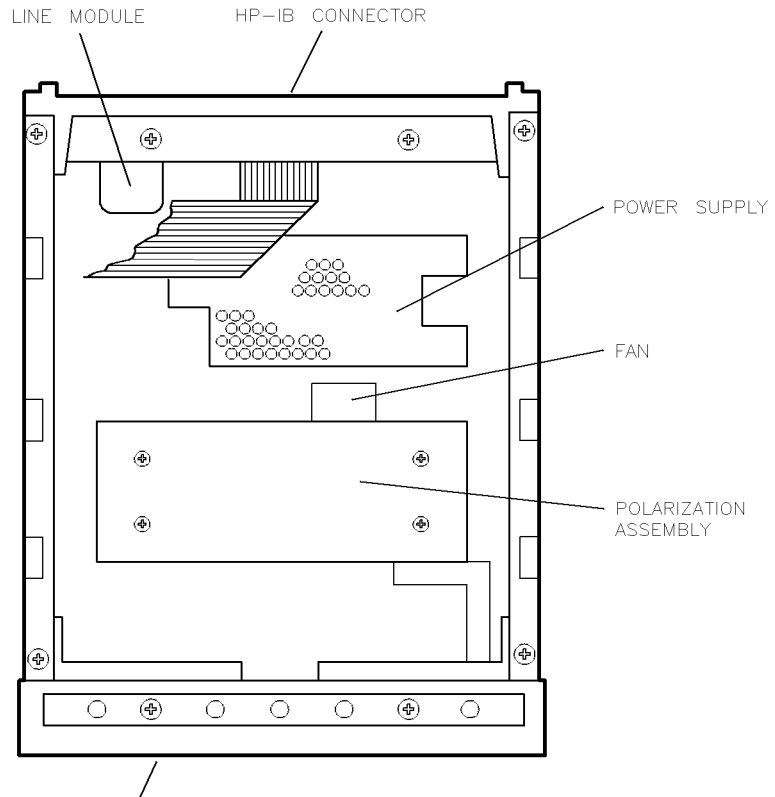

Figure 5-1. Agilent 11896A assembly level replaceable parts.

Table 5-3. Assembly-Level Replaceable Parts

Index Number	Agilent Part Number	Description
1	Agilent 11051	REAR PANEL ASSY
2	Agilent 11052	FRONT PANEL ASSY
3	Agilent 11053	OPTICAL MODULE
4	Agilent 28000	POWER SUPPLY

Verification and Service Information



A

Choosing the Scan Rate and Measurement Time

Choosing the Scan Rate and Measurement Time

Single wavelength PDL measurements

When using an optical power meter, the scan rate depends on the averaging time (T) of the instrument. In most applications, the received power is large enough so a short averaging time can be used. This ensures the fastest measurement. For example, the shortest averaging time of the Agilent 8153A lightwave multimeter power sensor is 20 ms.

Optimum measurements can be made when:

- The polarization state generated by the Agilent 11896A does not change significantly during the averaging time of the optical power meter.
- The polarization state changes fast enough to make the measurement in a period of time that avoids significant long term source drift.

When $T = 20$ ms, a scan rate of 5 is a good choice. A fixed measurement time is sufficient for devices with a PDL of <3 dB. A measurement time of ≤ 10 sec is sufficient to make PDL measurements with an accuracy of $\pm 5\%$ ($T = 20$ ms, Scan Rate = 5).

To ensure measurement accuracy of $\pm 5\%$, as the optical power meter averaging time increases, the scan rate must be decreased and the measurement time increased. Table A-1 shows combinations of power meter averaging time, scan rate and measurement time that can be used to ensure a PDL measurement accuracy of $\pm 5\%$.

Table A-1. Selecting Averaging Time, Scan Rate and Measurement Time

Optical Power Meter Averaging Time (T)	Scan Rate	Measurement Time
20 ms	5	10 s
50 ms	4	25 s
100 ms	3	50 s
200 ms	2	100 s

Swept wavelength PDL measurements

Typical parameters for the Agilent 71451A Option 002, white light source, and Option 003, swept PDL kit (with the Agilent 11896A), are shown below. Sweep times are in the range of 1 to 5 seconds.

Wavelength range: 1250-1600 nm
Reference level: <-50 dBm
Resolution bandwidth: 10 nm
Wavelength span: 100-350 nm
Video bandwidth: 30-300 Hz

It is best to use scan rate 1 for swept wavelength PDL measurements because each sweep of the optical spectrum analyzer is of essentially a single polarization. A total measurement time of five minutes allows the optical spectrum analyzer to make 60 to 300 sweeps, each with a random polarization. This time is sufficient to measure PDL with the Agilent 71451A, Options 002 and 003.

Depolarization application

When using scan rate 8, the polarization state at the output of the Agilent 11896A is changing fast enough to act as a depolarizer for detectors with a long averaging time. A detector averages over many polarization states during its averaging time and the polarization-dependent responsivity (PDR) of the detector is reduced or eliminated. A detector averaging time of two seconds is sufficient to reduce the detector PDR by a factor of ten. For example, a detector with an averaging time of two seconds and a 0.020 dB PDR with no depolarizer has a 0.002 dB PDR when preceded with the Agilent 11896A using scan rate 8. Averaging times of less than one second are insufficient to substantially reduce the detector PDR.

B

**Measurement
Considerations**

Measurement Considerations

Overall insertion loss

On the Agilent 11896A standard and Option 010, insertion loss is limited by the condition and cleanliness of the fiber optic connectors. The insertion loss of the Agilent 11896A Option 010 also depends on which connector family is used. The insertion loss of the Agilent 11896A versions having connectors will measure approximately 2.0 dB when using clean, undamaged FC/PC connectors.

NOTE

Even minor damage or contamination to the connector faces will result in a significant increase in insertion loss, therefore insertion loss is listed in Table 1-1 as a characteristic, non-warranted performance parameter.

Insertion loss variation with paddle position

When the paddles of the Agilent 11896A are rotated, fiber bend losses and polarization dependent losses may result in small changes in insertion loss. On the Agilent 11896A standard and Option 010, the insertion variation is determined almost entirely by the polarization dependent loss (PDL) of the fiber optic connector interface. The insertion loss variation with paddle position of the Agilent 11896A versions having connectors will measure approximately ± 0.02 dB when using clean, undamaged FC/PC connectors.

NOTE

Even minor damage or contamination to the connector faces will result in a significant increase in insertion loss, therefore insertion loss is listed in Table 1-1 as a characteristic, non-warranted performance parameter.

Optical return loss

On the Agilent 11896A standard and Option 010, the optical return loss is limited by the return loss of the fiber optic connectors. The return loss of the Agilent 11896A versions having connectors will measure approximately 35 dB when using clean, undamaged FC/PC connectors.

Measurement Considerations

NOTE

Even minor damage or contamination to the connector faces will result in a significant increase in return loss, therefore return loss is listed in Table 1-1 as a characteristic, non-warranted performance parameter.

Extinction ratio

The extinction ratio describes the ability of the Agilent 11896A polarization controller to adjust for all states of polarization. A specific, extreme example is shown in Figure B-1. The ratio of the maximum power to the minimum power that can be coupled through the second polarizer is the extinction ratio. In the Agilent 11896A, the extinction ratio is determined by the angular resolution, ± 0.18 degrees, of the paddles. This assumes the degree of polarization of the input signal to the Agilent 11896A approaches 100% and the extinction ratio of the second linear polarizer exceeds the extinction ratio of the Agilent 11896A.



Figure B-1. Block diagram for testing the extinction ratio of the Agilent 11896A.

Paddle angle repeatability

Paddle angle repeatability is a measure of the paddles ability to accurately return to a previous physical position. Paddle angle repeatability cannot be used to quantify the state of polarization (SOP) repeatability because a given paddle rotation angle affects SOP differently, depending on the input SOP.

Settling time

Settling time is defined as the worst-case time for the Agilent 11896A to recall and stabilize at a new set of paddle positions. The settling time is approximately proportional to the maximum rotation angle through which any paddle must travel.

Paddle rotation rates

The four paddles in the polarization controller each rotate so all states of polarization are generated or scanned in a random fashion. There are eight scan rates, where rate 1 scans most slowly and rate 8 scans most quickly.

Nominal quarter-wave plates

The polarization controller's paddles have a nominal quarter-wave of birefringence between 1300 nm to 1550 nm. All polarization states can be generated from any input polarization state over the operating wavelength range because of the redundancy given by the four paddles.

Measurement Considerations



Index

Index

- A** :ABORt, 4-27
accessories, 1-4, 2-3
ac power
 cables, 2-6
 connection, 2-4
address display/change, 3-11
addressing, 4-16
adjustment procedure, 5-16
Agilent maintenance contract, 5-6
Agilent Technologies Service Offices, 5-12
application setup, 1-3
assembly-level replaceable parts, 5-21
assembly replacement, 5-17
- B** before servicing the Agilent 11896A, 5-6
blue repair tag, 5-10
bus command
 device clear (DCL), 4-18
 interface clear (IFC), 4-18
- C** calibration, recommended interval, 1-11
certification information, iii
changing the GPIB address, 4-3
check digit, 5-19
checking the fuse, 2-4
cleaning of connectors/adapters, 2-11-13
*CLS (Clear Status), 4-19
combining commands, 4-8
command instructions, 4-6
command mode operation, 4-15
commands
 common, 4-19-26
 instrument specific, 4-27-34
 output, 4-5
common command header, 4-8
common commands, 4-19-26
compound command header, 4-8
configuration
 instrument, 1-4
conformity, 1-13
conformity to ISO/IEC, 1-13

- connector
 - care, 2-9-14
 - compatibility, 2-15
 - insertion technique, 2-15
 - interface, 2-9
 - loss, 2-9
- continuous sweep of polarization states, 3-9
- customer assistance, v

- D** data entry keys, 3-4
- data mode operation, 4-15
- declaration of conformity, 1-13
- depolarization application, A-4
- description of the Agilent 11896A polarization controller, 1-3
- device address, 4-5
- device clear (DCL) command, 4-18
- dimension specifications, 1-12
- direct mail-order system, 5-20
- direct phone-order system, 5-20
- display screen, 3-4
- duplicate mnemonics, 4-9

- E** electrostatic discharge (ESD), 1-15
- error codes on front panel display, 3-5
- error messages, 4-33
- ESD
 - protection, 1-15, 5-15
 - reducing damage caused by ESD, 1-17
 - static-safe accessories, 1-17
 - static-safe work station, 1-15
- *ESE (Event Status Enable), 4-20
- *ESR (Event Status Register), 4-21
- event timer verification, 5-5
- extinction ratio, 1-12, B-4

- F** fiber optic cables, 2-9
- four-fiber loop assembly, 1-10
- front panel
 - assembly replacement, 5-17
 - error codes, 3-5
 - features, 3-3-5
- fuse, 2-4

- G** GPIB
- changing the address, 4-3
 - connector replacement, 5-18
 - display/change address, 3-11
 - local function, 3-11
 - rear panel connector, 3-6
- H** handling of connectors/cable ends, 2-11
- header types, 4-7
 - hotline orders, 5-20
 - humidity, 1-12
- I** *IDN (Identification Number), 4-22
- initial inspection, 2-3
 - initialization, 4-14
 - :INITiate:IMMEDIATE, 4-27
 - input power, 1-12
 - insertion loss, 1-12, 2-9, B-2
 - optical performance, 2-17
 - paddle position, B-3
 - verification, 5-7
 - instruction header, 4-6
 - instructions (command/query), 4-6
 - instrument
 - address, 4-17
 - configuration, 1-4
 - specific commands, 4-27-34
 - state, 3-10
 - instrument state keys, 3-4
 - interface clear (IFC) command, 4-18
 - interface select code, 4-17
 - ISO/IEC conformity, 1-13
- L** lightwave connector care, 2-9-14
- local command, 4-18
 - local function verification, 5-4
 - lockout command, 4-18
- M** maximum allowable input power, 1-12
- measurement time, A-2-3
 - multiple program command/query, 4-13

- N**
 - nominal quarter-wave plates for paddles, B-5
 - non-operating temperature, 1-12
 - numeric program data, 4-12

- O**
 - *OPC (Operation Complete), 4-22
 - operating specifications, 1-12
 - optical performance
 - insertion loss, 2-17
 - return loss, 2-18
 - optical return loss, 1-12, B-3
 - options, 1-4
 - output command, 4-5
 - output queue, 4-10

- P**
 - packaging materials, 5-9
 - paddle
 - adjustment, 1-12, 3-7
 - angle repeatability, B-5
 - position, B-3-5
 - :PADDle:POSition, 4-28
 - parser, 4-14
 - part ordering information, 5-19
 - PDL measurement
 - polarization-dependent, 1-5
 - single-wavelength, 1-5, 3-7, A-2
 - single-wavelength max/min, 1-8
 - swept-wavelength, 1-6, A-3
 - wavelength-scanning, 3-7
 - performance specifications, 1-12
 - physical specifications, 1-12
 - polarization
 - adjustability, 1-10
 - adjustment keys, 3-4
 - assembly replacement, 5-18
 - controller accessories, 2-3
 - extinction ratio, 1-12
 - states, 3-9
 - turning on the controller, 2-8
 - polarization-dependent loss measurement (PDL), 1-5
 - power cable, 2-5
 - power consumption, 1-12
 - power input
 - rear panel, 3-6
 - power meter PDL measurement, 1-5
 - power requirements, 1-12, 2-4
 - power source connection, 2-4
 - power supply

- adjustment, 5-16
- replacement, 5-18
- power switch, 3-8
- program message syntax, 4-5-14

Q query command, 4-10
query instructions, 4-6

R random sweep of polarization states, 3-9
*RCL (Recall), 4-23
rear panel features, 3-6
recall function verification, 5-4
recalling an instrument state, 3-10
recall/save registers, 3-7
regular orders, 5-20
regulatory information, 1-13
reliability considerations

- servicing, 5-15

remote control

- GPIB, 3-11

remote mode operation, 4-16remote programming, 3-7

- combining commands, 4-8
- command/query instructions, 4-6
- common command header, 4-8
- compound command header, 4-8
- defined, 4-2-18
- device address, 4-5
- duplicate mnemonics, 4-9
- header types, 4-7
- initialization, 4-14
- instruction header, 4-6
- multiple program command/query, 4-13
- numeric program data, 4-12
- output command, 4-5
- output queue, 4-10
- program data, 4-7
- program data syntax, 4-12
- program header, 4-11
- program message terminator, 4-13
- query command, 4-10
- simple command header, 4-7
- white space (separator), 4-6

repair options, 5-6replaceable parts, 5-19, 5-21replacement procedure, 5-17returning the Agilent 11896A for service, 5-9return loss, 2-9

- optical, B-3
- optical performance, 2-18
- verification, 5-8
- rotation rates for paddles, B-5
- *RST (Reset), 4-23

S safety

- information, 2-5
- symbols, vi
- safety considerations, vii, 1-15
- servicing, 5-14
- sales and service offices, 5-12
- save function verification, 5-4
- save/recall registers, 3-7
- saving an instrument state, 3-10
- *SAV (Save), 4-23
- :SCAN:RATE, 4-29
- scan rate, A-2-3
 - setting, 3-9
 - verification, 5-3
- :SCAN:TIMer, 4-29
- :SCAN:TIMer:CLear, 4-30
- selected device clear (SDC) command, 4-18
- serial numbers, 1-14, 5-14
- service
 - assembly-level parts, 5-21
 - information, 5-14
 - options, 5-6
 - returning the Agilent 11896A, 5-9
 - tools, 5-16
- Service Request Enable Register, 4-24
- setting the scan rate, 3-9
- settling time for paddles, B-5
- shipping
 - materials, 2-3, 5-9
 - preparation procedure, 5-10
- simple command header, 4-7
- single-wavelength
 - max/min PDL measurement, 1-8
 - measurement time, A-2
 - PDL measurement, 1-5
 - scan rate, A-2
- specifications
 - verification, 5-7
- *SRE (Service Request Enable), 4-24
- Standard Event Status Enable Register, 4-20
- Standard Event Status Register, 4-21-22
- startup verification, 5-3

- states of polarization (SOP), 3-7
- Status Byte Register, 4-24-25
- status indicators, 3-4
 - :STATus:OPERation:CONDition, 4-30
 - :STATus:OPERation:ENABle, 4-30
 - :STATus:OPERation:EVENT, 4-31
 - :STATus:PRESet, 4-31
 - :STATus:QUEStionable:CONDition, 4-31
 - :STATus:QUEStionable:ENABle, 4-32
 - :STATus:QUEStionable:EVENT, 4-32
- *STB (Status Byte), 4-25
- storage of connectors/adapters, 2-14
- storage temperature, 1-12
- swept-wavelength
 - measurement time, A-3
 - PDL measurement, 1-6
 - scan rate, A-3
- :SYSTem:ERRor, 4-33
- :SYSTem:VERSion, 4-34

T torque requirements, 2-15

- *TST (Test), 4-26
- turning on the polarization controller, 2-8

V verification check, 5-3

- failure, 5-6

verifying

- event timer, 5-5
- insertion loss, 5-7
- local function, 5-4
- recall function, 5-4
- return loss, 5-8
- save function, 5-4
- scan rate function, 5-3
- specifications, 5-7
- startup, 5-3

visual inspection, 2-16

W *WAI (Wait), 4-26

- warranty information, ii, iv, 5-6
- weight specifications, 1-12
- white space (separator), 4-6

Free Manuals Download Website

<http://myh66.com>

<http://usermanuals.us>

<http://www.somanuals.com>

<http://www.4manuals.cc>

<http://www.manual-lib.com>

<http://www.404manual.com>

<http://www.luxmanual.com>

<http://aubethermostatmanual.com>

Golf course search by state

<http://golfingnear.com>

Email search by domain

<http://emailbydomain.com>

Auto manuals search

<http://auto.somanuals.com>

TV manuals search

<http://tv.somanuals.com>