

Air King[®]

Ventilation Products

SPECIFICATIONS

ASLC70

EXHAUST FANS

70 CFM/4.0 SONES @ 0.10" WG. -HVI CERTIFIED
120 Volts, 1.6 amps, 60 hz.

- Grill**
 White polymeric grill secured in place via screw mounting through the light housing, dimensions - 11" x 10 1/2".
- Light Lens**
 High impact polycarbonate lens, secured in position using integral tabs; easily removed if necessary.
- Light Housing**
 Heavy gauge cold rolled steel c/w baked enamel finish; locks in place on the grill via two integral tabs.
- Blower Wheel**
 One piece polymeric wheel, 4 1/2" diameter, 1" wide, with 10 fins.
- Motor**
 Single coil plug-in, two pole motor, life time lubrication, thermally protected. Rated 120 volts, 60 hz., 1.6 amps.
- Fan Housing**
 23 ga. Galvanized metal housing, dimensions 7 3/8" x 7 5/8" x 5 7/8", double metal thickness mounting tabs.
- Duct Collar**
 Plastic collar for 4" duct connection, comes complete with built in non-metallic back draft damper for quiet operation.
- Lighting**
 100 watt maximum, type A19, medium base bulb.

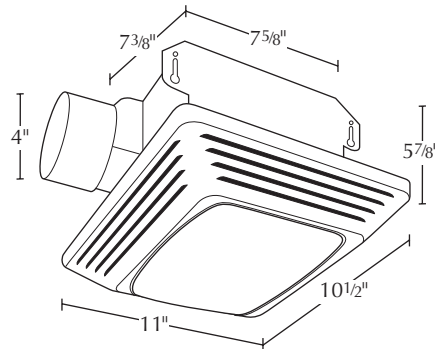

CUL/HVI

Acceptable for use over tub or shower when installed in a GFCI protected branch circuit.

- Unit Mounting**
 Rated Type IC for ceilings insulated to R-40. Designed to mount in ceilings with at least 6" of clearance. The unit will mount directly to the joist or using the supplied mounting bars with a rough in opening of 7 5/8" x 7 7/8". The housing will mount through drywall thickness up to 3/4".
- Ventilating Area**
 For bathrooms up to 70 sq. ft. for other rooms up to 85 sq. ft.
- Single Pack Shipping Info**
 Box Dim: 11 3/4" x 13 1/4" x 9 3/8"
 UPC: 0-8316227611-7
 Shipping Weight: 6 lbs.

PERFORMANCE											
	Static Pressure (inches of w.g.)								HVI Sones @ .1 SP	Fan Speed RPM	Power Watts
	0	0.05	0.1	0.125	0.15	0.2	0.25	0.3			
Air Flow - CFM	77	73	70	69	68	66	64	62	4.0	1725	44

PROJECT							ARCHITECT				
LOCATION							ENGINEER				
CONTRACTOR							SUBMITTED BY			DATE	
FAN NUMBER	MODEL NUMBER	CFM	IN W.G.	RPM	WATTS	AMPS	SONES	QTY	OPTIONAL EQUIPMENT & REMARKS		



U.S.: 820 Lincoln Drive
 West Chester, Pennsylvania 19380-4466
 Tel: (610) 692-7400 • 877-304-3785
 Fax: (610) 696-8048

Canada: 110 Glidden Road
 Brampton, Ontario L6T 2J3
 Tel: (905) 456-2033
 Fax: (905) 456-1015

Free Manuals Download Website

<http://myh66.com>

<http://usermanuals.us>

<http://www.somanuals.com>

<http://www.4manuals.cc>

<http://www.manual-lib.com>

<http://www.404manual.com>

<http://www.luxmanual.com>

<http://aubethermostatmanual.com>

Golf course search by state

<http://golfingnear.com>

Email search by domain

<http://emailbydomain.com>

Auto manuals search

<http://auto.somanuals.com>

TV manuals search

<http://tv.somanuals.com>