

Airfree[®]
A I R P U R I F I E R S

Instruction Manual

Instruction Manual

The World's Safest and most Tested Air Purifier

Airfree Enviro 60
Airfree Enviro 60

Copyright 2001-2003 Policon Ltd. All Rights Reserved

All rights reserved. No part of this publication may be reproduced, photocopied, transmitted, transcribed, stored in a retrieval system, or translated into any language in any form or by any means without the express prior written consent of Policon Ltd.



Index

Introduction	3
Applications	4
Airfree and Mold	7
Technical Characteristics	8
Airfree Description	9
Installing and Connecting	10
Safety Instructions	12
How does Airfree work?	13
Airfree's Independent and Efficiency Tests	14
FAQ - Frequently Asked Questions	15
Warranty	19

Congratulations for having purchased your Airfree.

Airfree air purifiers are manufactured under license of US Patent 5,874,050, and many other patents pending worldwide. Airfree was designed with most advanced American and German technologies, to drastically destroy indoor airborne micro-organisms and reduce ozone.

Different from other air purifier manufacturers, Airfree does not spend much time in describing fancy technologies with difficult words and theories. Airfree offers independent efficiency tests instead.

For every Airfree claim there is one independent test to prove it!

Please carefully read this manual to achieve the best air purifying results.

Enjoy your Airfree.

Thank you,

AIRFREE PRODUCTS

The Invisible Enemies

Most people spend around 90% of their time indoors, at home or in the office.

The EPA – Environmental Protection Agency, claims the quality of air indoors can be 100 times worse than outdoors.

Some factors contribute to indoor contamination:

- High concentration of people in rooms increase fungus, bacteria and virus development, and cross contamination;
- New building insulation techniques reduce outside air interchanges and consequently air conditioning running cost, but in turn drastically increase mold, and bacteria colonies
- Deficient air conditioning duct cleaning
- Concentration of organic material such as books, carpeting, curtains, and sofas.

Good air quality indoors is a must for those affected by respiratory diseases and allergies.

Contaminated indoor air (fungus, airborne allergens, pollens, ozone) can trigger

- Asthma, bronchitis, rhinitis, and sinusitis
- Fungal infections in immune depressed patients
- Eye, throat and nose irritation
- Headaches, lethargy, irritability
- Cough and difficulty in concentration

Relation between microorganisms and related diseases.

$$\frac{\text{Inoculum}^{(*)} \times \text{Virulence}^{(**)}}{\text{Human Resistance}}$$

(*) Quantity of microorganisms (**) Microorganism aggressiveness

The higher “Inoculum” and “Virulence” and or the lower “Human resistance” results in greater contamination risk to people. The main contamination causes are several types of fungus, some of them already resistant to the most powerful chemicals and poisons, bacteria, viruses, and the fine dust from dust mite faeces and skeletons that contain powerful allergens and hazardous fungus, and the seasonal pollens.

Airfree can safely and silently destroy those allergens

Applications



Healthy rooms with pure clean air:

The efficient and noiseless Airfree technology safely destroys mold spores, bacteria, viruses and other airborne organic microorganisms.



Respiratory allergies and Asthma

Airfree drastically reduces airborne organic allergens and Ozone, providing cleaner and safer environment for allergic people. Airfree destroys mold spores, bacteria, viruses, dust mite allergens, pet dander and reduces Ozone, all kept to minimum levels.



Children and Newborns

Studies demonstrate that reducing dust mite allergen exposure to young children will lessen the development of asthma.

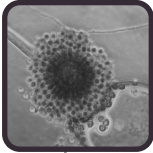

Mold and Mildew:

Airborne Mold spores that float throughout the house potentially cause allergic reactions. Those spores also start new mold colonies and expand existing ones. Airfree destroys airborne mold and mildew spores, helping to prevent new contaminations.



Odors:

Airfree can reduce some odors like "mildew smell" and other organic odors.



Kitchens and Pantries

The reduction of airborne fungi and spores in areas protected by Airfree helps to prevent mildew on food.



Video, films, slides, sound and optical equipment

The reduction of airborne spores in rooms protected by Airfree provides the best environment to store cameras, videos, pictures, slides, negatives and any device potentially affected by fungi. Quietly and safely Airfree protects your belongings and memories.



Yatches, Cruisers

Airfree safely eliminates fungi spores, mold, mildew, dust mites, bacteria, and strange odors. Many of which contribute to many common problems to boat owners.



Offices, Public Buildings,

Populated rooms, corridors, and elevators offer a constant contamination risk to employees and guests. This situation is aggravated by the flow of hazardous fungi and other microbes entering through the A/C system, and the ozone generated by computers and photocopiers. The spread of airborne transmittable diseases can accelerate in this environment. Airfree is a powerful weapon in the reduction of airborne contamination by viruses, bacteria, fungi, and a myriad of allergens.



Libraries and Museums:

The fungi spores that become mold or mildew are always present. When the temperature and moisture in the environment are suitable for germination, the spore bursts and growth begins. This growth contaminates books, clothing, documents, and works of art. Airfree destroys mold and mildew, providing a healthier environment for users and employees.



Schools, Kindergartens:

Airborne transmittable diseases are a great concern for students, parents, teachers, and principals. Influenza, meningitis, rubeolla, and other nasty microbes flow freely in the air. The use of Airfree in classrooms demonstrates the principal's concern for their students and staff well being. It also reduce school exposure to lawsuits, like with mold-affected diseases so may common throughout the USA.



Hospitals, Clinics and Laboratories:

Airborne contamination is quite a concern for most hospitals. With Airfree, the hospital environment becomes safer. Airfree is indispensable in waiting rooms, infirmaries, and recovery rooms due to its efficiency in destroying airborne viruses bacteria, and fungi. Airfree also reduces ozone that can affect patients with respiratory ailments. Laboratories no longer need to stop all activities for chemical air disinfection, gaining working hours.



Restaurants

Airfree offers continuous air sterilization. Silently, Airfree provides the additional protection that patrons expect. All viruses and bacteria that pass through Airfree's patented sterilizing ceramic core are destroyed. Restaurants are recommended to submit their floor plans to insure proper coverage inside their facilities.



Hotels and Retire Homes:

The use of Airfree in guest rooms shows concern on behalf of the hotel to its guests well being. The use of Airfree can contribute to a higher occupancy rate and may provide a good line of defense in case of lawsuits. Airfree has independent tests proving its efficiency.



Pollens

Pollens are no exception and like microorganisms are totally destroyed when passing through Airfree patented sterilizing core. After being incinerated the resulting harmless particles are released back to the environment.

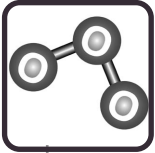

Ozone (O3)

Ozone is a very toxic gas that according to EPA can damage lung tissue, cause chest pain, throat irritation and trigger asthma. The FDA, the US Food and Drug Administration, recommends not to use any equipment directly or indirectly generating ozone in Hospitals or where the patients are present.

Airfree is proven to reduce ozone levels in 26%, every time air passes through its ceramic core.

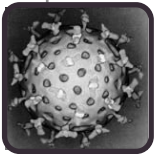

Viruses, Bacteria, Fungus and Germs

Airfree destroys all airborne microscopic threatening microorganisms cited above including the smallest microbes like those of meningitis, pneumonia and scarlet fever that can not be trapped in air filters or in other equipment using different technologies. Scientists confirm that virus, fungi and bacteria molecular structure (composed by proteins), can not survive high temperatures as those seen inside Airfree patented ceramic core.



Dust Mites

Many allergic reactions are caused by dust mites.

The fine dust generated from their skeletons and excrements contain hazardous fungus and allergens that when inhaled cause allergic reactions. Those allergens and fungus are totally destroyed inside Airfree ceramic core.

Fungus reduction by Airfree in the indoor environment also reduces dust mite population as they need certain types of fungus to survive.

Airfree and Mold

Guide for Airfree Installation in Mold contaminated rooms

- 1 - Install your Airfree unit in accordance with the user manual
- 2 - Allow your unit to run for at least one week to achieve significant airborne mold spore reduction.
- 3 - Clean mold infected items and surfaces, since they are a continuous source of new spores.

It is important to stress that Airfree will not destroy or remove mold from an infected item or surface. Those surfaces must be cleaned manually.

Airfree will prevent spores released by existing mold colonies from contaminating other areas, and will inhibit the growth of existing colonies.

Airborne mold spores in a regular bedroom



Without Airfree



With Airfree

Illustration images based on Airfree Independent Test results.
Results may vary depending on the room and environment conditions.

Technical Characteristics



Model	Enviro 60
Capacity	2,000 cu.ft (60m ³)
Inside Temperature	392°F (200°C)
Electric Consumption	46W
Voltage	230v or 120v
Noise	Totally Silent
Weight	4 lbs (1,8 Kg)
Dimensions	10 in height 8 in Ø 25 cm height 20 cm Ø

Airfree Description

- 1- Top Lid with Air outlets
- 2- Grooves
- 3- On/Off Led
- 4- Feet
- 5- Fuse
- 6- Bottom lid
- 7- Power Cord

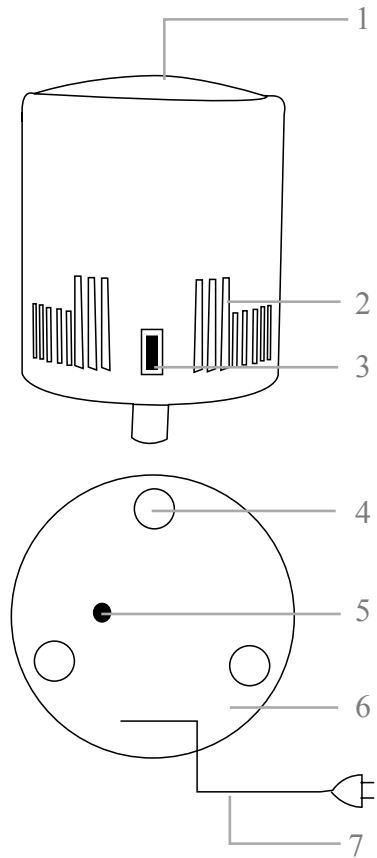

Installing and Connecting



Plug power cord to the nearest outlet. Make sure the surface is dry (never place Airfree in wet floor or immerge in water) After 10 minutes the top lid should be warm.



Place Airfree on the floor. Do not install it under furniture or shelves, behind curtains as it will reduce air flow and Airfree efficiency in reducing microorganisms.



Place each Airfree in rooms up to 216 sq. ft. (24m²) . For larger rooms use proportionally additional Airfree units. The use of just one Airfree in rooms larger than recommended will considerable reduce Airfree efficiency.

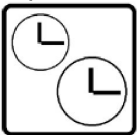

Airfree must be continuously on in the same room 24 hours/ day.



Airfree can only be used in rooms with minimum air volume of 330 cu. ft. (10 m³), free of obstacles.



Airfree can be installed in rooms equipped with air conditioning and heating systems. However it is recommended not to place Airfree nearby them to avoid potential interference in Airfree air flow.



Do not place Airfree in the corridor to try to reach the whole house. In this case Airfree will only reduce air pollution in the corridor area.

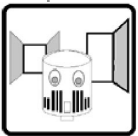

Airfree works better in rooms with windows closed. Nevertheless opening up window in the morning for one hour or two hours to allow air interchange with the outside will not affect Airfree efficiency. Airfree shall not be placed near doors or under windows to avoid sterilized air to exit the room.

Safety Instructions



Airfree can not be installed on wet surfaces or immersed in water like any other electric appliance.



Please do not attempt to open Airfree or touch interior electric parts. Such attempt may cause electric shock hazard. If any mal function occurs please contact Airfree authorized repair centres or call the shop where Airfree was purchased.



If there is a temporary loss of energy Airfree will take the same time to recover the previous contamination level.



Do not place clothing, towels or any article on or around Airfree that can stop or diminish the Airfree's air flow mainly at the top sterilized air exhaust as it can cause over heating, irreparable damage to the device and potential fire hazard.

How does Airfree Work?

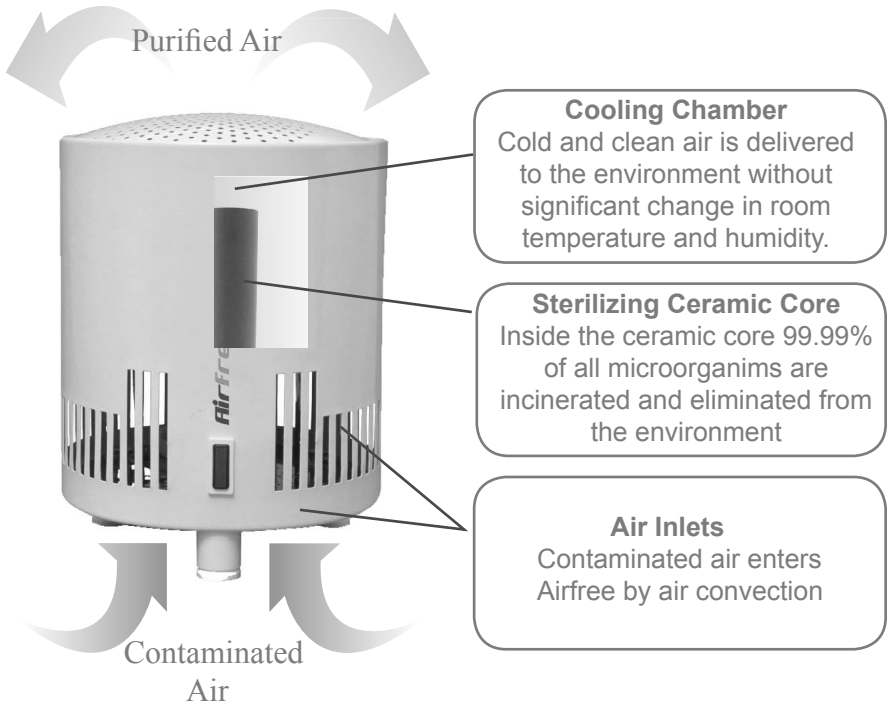

How Airfree works?

Contaminated air silently enters Airfree by air convection and is sterilized inside Airfree patented ceramic core where all microorganisms are destroyed/ incinerated at high temperatures. Regardless of how hazardous a virus, fungus or bacteria might be they can not resist the powerful heat inside the ceramic core and are incinerated. The heat inside the ceramic core forces sterilized air out to the heat exchanger causing air convection, which generates negative pressure underneath the ceramic core, so contaminated air is "sucked" in at Airfree bottom air inlets in a continuous and silent thus efficient air flow.

The association of the ceramic core, special ceramic and air flow reduces at the same time toxic Ozone.

Airfree Independent and Efficiency Tests

AIRFREE EFFICIENCY TESTS BY INDEPENDENT LABORATORIES, INSTITUTES AND UNIVERSITIES IN FOLLOWING COUNTRIES.

Laboratory	Local	Reduction of Microorganisms		
		Fungus	Bacteria	Dust Mite allergens DerP-1
Insect R&D Limited september to november, 2000	Laboratory			70,6% to 97,95%
SGS Natec Institute* Hamburgo/Germany september to november, 2000	Laboratory Office	99%	99%	
Technical Micronics Control Huntesville/USA april 28 to may 14, 1998	Laboratory	93%	78%	
Univ. Complutense de Madrid Madrid/Spain october 21, 1997	Clinical Laboratory	80%	73%	
AINIA Valença Spain june 9 to august 22, 2003	Cold Chamber	86%		
INETI* Lisbon/Portugal january 13 to february 18, 1999	Torre do Tombo Portuguese National Archive	93%	94%	
INETI* Lisbon/Portugal may 7 to june 18, 1999	RTP Video Archive	74%	70%	
INETI* Lisbon/Portugal april 3 to may 5, 1998	Bank Branch	77%		
Univ. Nova of Lisbon june 5, 1998	Laboratory	90%	62%	
Campana Laboratory/ São Paulo/Brazil april 14 to april 29, 1999	Chemical Laboratory	99%	83%	
INETI* Lisbon/Portugal november 12 to december 10, 2004	Closed Environments	98%	87%	
INETI* Lisbon/Portugal march 19 to april 30, 2001	Hotel Rooms	92%	82%	

Above and other tests can be seen at our web site www.airfree.com

* Certified by ISO 17025

FAQ - Frequently Asked Questions

1. How does Airfree work?

Airfree incinerates microorganisms at its heated capillaries. Contaminated air is dragged into Airfree's ceramic core by air convection and microorganisms are destroyed at high temperatures regardless of how resistant and dangerous they might be.

2. Are there any side effects?

No. Airfree's new technology uses heat to purify the air. No side effects, no emissions, NO IONS, nor new particles are generated. Airfree should be used in all homes and offices quietly, constantly and efficiently purifying the air.

3. What is Airfree's air cleaning capacity?

Airfree Enviro 60 was designed for rooms up to 216 sq. ft. (24m²) . For larger rooms more than one Airfree must be used.

4. Can I install Airfree in my walking closet ?

Yes, as long as it has at least 400cu.ft (11m³)*. Airfree should not be placed under shelves or its efficiency will be reduced.

* as reference 400cu.ft (11m³) is approximately 7'x7'

5. Can I use Airfree in air conditioned rooms?

Yes.

6. How do I know if Airfree is no longer working?

Check the top lid and if warm Airfree is working.

7. Can I place Airfree at the corridor to reach the whole house?

No. Airfree will just reduce air pollution in the corridor's area.

8. Can I place Airfree in a closed room?

Yes. Please remember such a room must have at least 400cu.ft (11m³)*.

* as a reference 400cu.ft is approximately 7'x7'

9. Is it necessary to keep doors and windows closed?

It is preferable. But opening window for 1 or 2 hours a day will not affect Airfree efficiency.

10. Does Airfree eliminate bacteria and viruses?

Yes. Unlike the air filters in the market Airfree is more efficient with the smallest microorganisms as they are easily carried by Airfree's airflow into its heated ceramic core.

11. Can I change Airfree from one room to another?

Airfree must always be plugged in the same room 24 hours a day. Airfree's patented technology works gradually and cannot have its cycle interrupted. Moving it from one room to another will interrupt the cycle and will recontaminate the room. See question 13 below.

12. Should I turn off Airfree when I leave house?

No. Airfree must always be on.

13. What happens if Airfree is disconnected or there was a black out?

Airfree will take approximately the same time to recover the previous reduced contamination level.

14. Does CADR measure the effectiveness of the Airfree?

Not at all. CADR is not designed to test the Airfree technology.

The AHAM seal (usually found on the back of an air cleaner's box) lists three Clean Air Delivery Rate (CADR) numbers: one for tobacco smoke, one for pollen and one for dust. The CADR indicates volume of filtered air delivered by an air cleaner. The higher the tobacco smoke, pollen and dust numbers, the faster the unit filters the air.

The main reason why CADR is not designed for Airfree is because Airfree does not filter but destroys microorganisms instead, CADR only applies to volume of filtered air delivered by an air cleaner as stated above.

CADR does not measure microorganism reduction like mold and bacteria only detectable by a microbiology lab.

Airfree destroys (not trap or attract to other surface) any microorganism regardless of how small they might be. 99,99% of all organic particles are fully destroyed when passing through the Airfree U.S. patented ceramic core.

15. How does Airfree destroy dust mites?

Mold reduction in the atmosphere causes a reduction in the mold dependant dust mite population.

Airfree also destroys the harmful toxins and fungus freed by dust mite feces that trigger respiratory allergies.

16. How does Airfree eliminate fungi?

As mentioned before, Airfree eliminates airborne microorganisms included fungi and spores. By eliminating spores new colonies are unlikely to develop, representing less airborne spores.

17. How does Airfree destroy viruses?

Those microscopic microorganisms are easily eliminated inside Airfree's ceramic core capillaries. The temperature inside of Airfree's capillaries is much higher than required to incinerate them. Airfree is your greatest ally in respiratory disease prevention.

18. Does Airfree reduce tobacco smell?

Yes, Airfree reduces any kind of organic smell in the ambience including tobacco.

19. Does Airfree release any gas or chemical product?

No. Airfree's sterilization process is natural. Please check our website for conclusive tests regarding particles and O3.

20. Does Airfree heat up a room?

No. Airfree does not increase room temperature. To have an idea 2 Airfree's plugged in the same room will contribute as much heat as the presence of one adult in that same room.

21. Does Airfree provoke any change in room's the relative humidity?

No.

22. Does Airfree need filter replacement?

No. Airfree's technology uses just heat.

23. Does Airfree consume a lot of energy?

No. Airfree's consumption is just 46 Watts equivalent to a small light bulb.

Warranty

Warranty Certificated - 2 years

Model: _____ Serial Number _____

Client Name: _____

Address: _____

City: _____

Zip Code: _____

Phone Number. (__) _____

Purchase Date ____ / ____ / ____

Store Name: _____

Invoice Number: _____



In order to obtain full warranty terms and conditions as stated above
please fill in and return Warranty Certificate to
Authorized Airfree distributor.

You may also register your warranty at support session at
www.airfree.com

Warranty

This product is warranted by AIRFREE PRODUCTS, to the original purchaser to be free from defects in material and workmanship under proper use for a period of two years from date of purchase. During this period, and upon proof of purchase and date of purchase, this product will be repaired or replaced with same or similar model without charges for parts or labor (except for a \$10 charge for insurance and handling) at distributor address. To be eligible for the warranty, please complete your warranty card at the time of purchase and mail it to the distributor. To obtain warranty service, please send the product sales receipt or proof of Purchase, and a check or money order for \$10 payable to the distributor . This warranty does not apply to a product that has been misused, abused, or altered without limiting the afore-mentioned, bending or dropping the unit, defects in the electrical installation or fluctuating power levels are presumed to be defects resulting from misuse or abuse.

AIRFREE PRODUCTS and its affiliates or wholesalers do not make any specific claim as to medicinal uses of this product nor does the manufacturer warrant that the equipment prevents some kind of diseases.

NEITHER THIS WARRANTY NOR ANY WARRANTY, EXPRESSED OR IMPLIED, INCLUDING IMPLIED WARRANTIES OR MERCHANTABILITY, SHALL EXTEND BEYOND THE WARRANTY PERIOD. NO RESPONSIBILITY IS ASSUMED FOR ANY INCIDENTAL OR CONSEQUENTIAL DAMAGES, INCLUDING WITHOUT LIMITATION DAMAGES, SOME STATES DO NOT ALLOW LIMITATION ON HOW LONG AN IMPLIED WARRANTY LASTS; SOME STATES DO NOT ALLOW THE EXCLUSION OR LIMITATION OF INCIDENTAL OR CONSEQUENTIAL DAMAGES, SO THE ABOVE LIMITATIONS OR EXCLUSIONS MAY NOT APPLY TO YOU.

AIRFREE PRODUCTS HEREBY SPECIFICALLY DISCLAIMS ALL EXPRESSED WARRANTIES NOT OTHERWISE SET FORTH HEREIN AND ANY IMPLIED WARRANTIES OR MERCHANTABILITY OR IMPLIED WARRANTIES FOR FITNESS FOR A PARTICULAR PURPOSE. THERE ARE NO WARRANTIES WHICH EXTEND BEYOND THE DESCRIPTION OF THE FACE HEREOF. This warranty gives you specific legal rights; you may have other rights, which vary from state to state.

* AIRFREE PRODUCTS, Apartado 14306, LISBON 1064 - 828 PORTUGAL
- Tel.:351 - 213 156 222
- Fax: 351 - 213 516 228
- Web: www.airfree.com
- Mail: info@airfree.com



AIRFREE PRODUCTS
Tel.: 351 - 213 156 222
Web: www.airfree.com
Mail: info@airfree.com

Free Manuals Download Website

<http://myh66.com>

<http://usermanuals.us>

<http://www.somanuals.com>

<http://www.4manuals.cc>

<http://www.manual-lib.com>

<http://www.404manual.com>

<http://www.luxmanual.com>

<http://aubethermostatmanual.com>

Golf course search by state

<http://golfingnear.com>

Email search by domain

<http://emailbydomain.com>

Auto manuals search

<http://auto.somanuals.com>

TV manuals search

<http://tv.somanuals.com>