

OWNER'S MANUAL

PurePal[®] Air Cleaner (Model: AG800)
PurePal[®] Plus Air Cleaner (Model: AG850)



This air cleaner complies with the federal ozone emissions limit.
ARB CERTIFIED



Congratulations on your purchase of this Airgle® PurePal® air cleaner. Please study this manual carefully to familiarize yourself with the features and functions of your Airgle® PurePal® air cleaner. Inside you will find many helpful hints on how to use and maintain your Airgle® PurePal® properly.



WARNING

Important safety instructions

READ AND SAVE THESE INSTRUCTIONS











Read all instructions before using this air cleaner

When using an electrical appliance, basic precautions should always be followed, including the following:

- Make sure the cleaner is plugged into a live 110-120V AC outlet (if you purchased this unit outside the United States and Canada, your dealer may have already configured the unit to work with a live 220-240V AC outlet).
- Always turn off and unplug the air cleaner when not in use.
- Disconnect the power supply from your air cleaner by unplugging the power cable before replacing filters and before cleaning.
- Do not use attachments or filters not recommended by Airgle®.
- Do not use the air cleaner outdoors.
- Do not attempt to remove any part of the unit except the filters.
- Do not attempt to repair the air cleaner.
- Do not attempt to plug in the machine when your hands are wet.
- Do not soak the cleaner in water or splash water on it.
- Do not operate the air cleaner near an open flame.
- Do not obstruct the air inlet and air outlet of the air cleaner.
- To reduce the risk of electric shock, do not expose to water or rain.
- This product employs overload protection (fuse). A blown fuse indicates an overload or short-circuit situation. If the fuse blows, unplug the product from the outlet. Replace the fuse as per the user servicing instructions (follow product marking for proper fuse rating) and check the product. If the replacement fuse blows, a short-circuit may be present and the product should be discarded or returned to an authorized service facility for examination and/or repair.
- Do not run cord under carpeting. Do not cover cord with throw rugs, runners, or similar coverings. Do not route cord under furniture or appliances. Arrange cord away from traffic area and where it will not be tripped over.
- Save these instructions for future reference.



CONTENTS

	Warning: IMPORTANT SAFETY INSTRUCTIONS	2
	The Airgle® PurePal® Air Cleaning System	4
	Unpacking	6
	Choosing a Suitable Location	7
	Connecting to Power	9
	Airgle® PurePal® Components	10
	How the Airgle® PurePal® System Works	11
	Using the Control Panel	12
	Using the Remote Control	17
	Care and Maintenance of Your PurePal® Air Cleaning System	18



THE AIRGLE

The Airgle® PurePal® Air Cleaning System

An efficient air cleaning system plays an important role when it comes to improving indoor air quality. However, an air cleaning system cannot do the complete job – it needs assistance. Controlling the sources of air pollution and making sure proper ventilation is utilized are critical components in improving air quality in your home or office.

To tackle any indoor air quality problem, you will want to:

- Eliminate or reduce the source of air pollution as much as you can. Locating and controlling the source of pollution in your home right at the source is very effective.
- Proper ventilation is extremely important. Cleaning your air cannot reverse the fact that the air in your home or office is converted to carbon dioxide (CO₂) every time someone exhales. Proper ventilation will ensure that clean fresh air is continually introduced into the room from outside.

Ideally, when you purchased your new Airgle® PurePal® cleaning system, you had assistance in making sure that you were purchasing enough air cleaning power for your room size. However, if you are in an area with heavy air pollution or there other factors restricting sufficient ventilation and pollution control, you may need to evaluate your level of air turnover.

It is important to understand how to calculate the level of air turnover you desire/need. Obviously, the larger the room, the more air, and therefore the more power needed to purify the air. The calculation we use is as follows:

Room air volume x 5 = hourly delivery level to purify the air

Your new Airgle® PurePal® system can purify and circulate clean air 5 times per hour in a 698 sq. ft. room size.

Titanium Pro® Module

The AG850 comes with the Titanium Pro® module. This module is considered the next generation of Photocatalytic oxidation technology. The catalytic area in the module safely breaks down harmful chemicals and odors and effectively kills bacteria and virus pollutants.

Pollutants are absorbed by the surface of the catalyst. The pollutant and catalyst are then exposed to the photons of UV light. The light energy activates the catalyst, which breaks down the pollutant into nontoxic products. Odors and VOCs are vaporized by the UV light in much the same way that a drop of cold water is vaporized when it drops into a hot skillet.

Our patented pending Titanium Pro® includes the following features:

- A catalytic metal plate, an electronic component, a UV germicidal lamp and UV lamp ballast into a single disposable module - A single, handheld, unitized package, designed for easy insertion and removal into an air cleaner.
- Unique structure design allows maximum airflow, rapidly diluting the concentration of unwanted airborne contaminants.
- 6.40 times greater effective catalytic area, comparing other conversional Tio2 module
- 14 watt UVC lamp
- Plug and play technology
- High destructive efficiency at room temperature
- No chemical additives
- No residual ozone
- High oxidation yields for gas phase reactants and odors
- Low energy requirements
- Works in humid conditions
- Long service life
- Zero maintenance requirement

PurePal® and PurePal® Plus Air Cleaning Systems

Airgle® PurePal® (AG800) is designed:

- For general purpose usage
- To assist asthma & allergy sufferers
- With a wide spectrum particle, molecular and odor filtration system that includes
- A Gas & Odor filter (3 lbs enhanced carbon blend)
- A 50 sq. ft. HEPAfast surface area

Airgle® PurePal® Plus (AG850) is designed:

- With enhanced technology for particle, chemical, odor & microbe filtration
- The filtration configuration includes
- A Gas & Odor filter (3 lbs enhanced carbon blend)
- A 50 sq. ft. HEPAfast surface area
- Includes Titanium Pro®

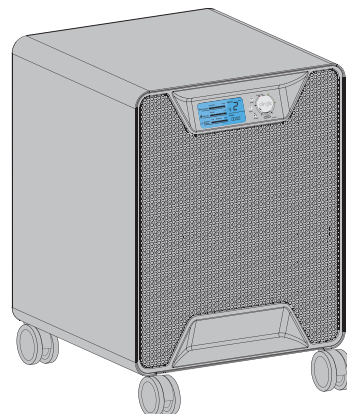



UNPACKING

Unpack your Airgle® PurePal® System as follows:

1. Remove the PurePal® System from the packaging.
2. Do not throw the original box and packaging away. Keep it in case you have to transport the unit again sometime in the future.
3. Check the components received against your packing slip to make sure you have all the parts.
4. Check the unit and all the components for damage. If the unit or any of the components show damage from shipping, contact your local dealer.
5. For your future convenience, record the model information here. Model information can be found on the name plate located on the bottom of your unit.

Model Number:	Model Name:
Purchase Date:	Serial Number:

Pre-installed Filters:
Gas & Odor filter, HEPAfast filter, and Titanium Pro® (AG850)

Installing the supplied casters. They make it easy to move the air purifier between rooms.

- 1) Carefully insert caster stem into receptor tube.
- 2) Press on caster, until it snaps into place. Repeat steps 1) and 2) with the remaining casters.
- 3) Ensure that each caster is securely fitted before placing the machine in its upright position onto the casters.

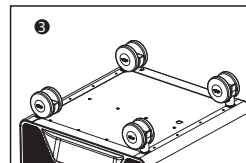
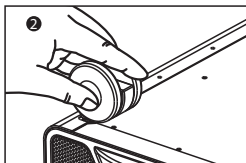
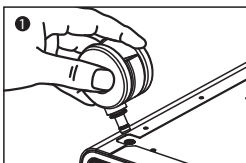
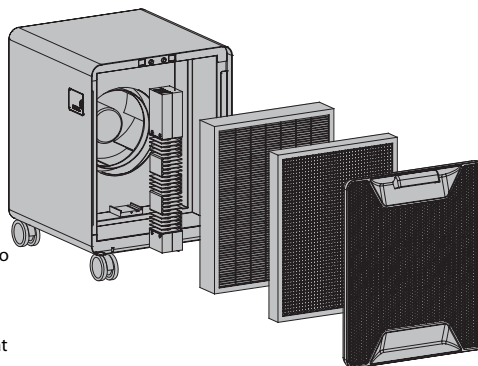



CHOOSING A SUITABLE LOCATION

Now that you have unpacked your air cleaning system, where are you going to use it?

Bedrooms:

Does someone in your family have allergies and asthma? People with allergies and asthma sometimes have a hard sleeping as many of their symptoms worsen during the night. Moving your air cleaning system into your bedroom at night will help them. Be sure to have one foot of space between the system and any walls, cabinets or large furniture to allow for better air circulation.

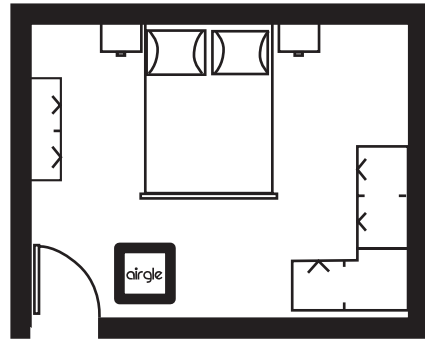

Living/family rooms:

Placing your air cleaning system in a central location of your largest room will help purify the air in the entire room and may be beneficial to other rooms that have doorways to the main room. Be sure to have one foot of space between the system and any walls, cabinets or large furniture to allow for better air circulation.



Home office or den:

Keeping your system in your home office or den will certainly clean the air in that room – but probably only that room.

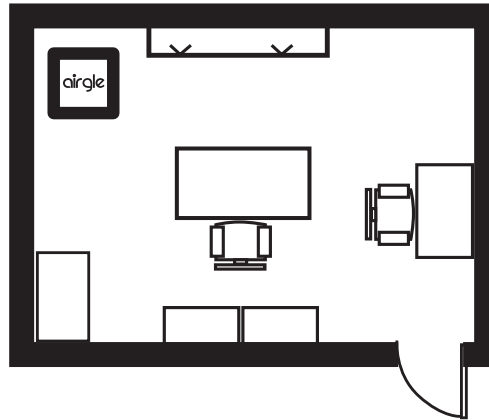

Many people will turn on their air cleaner periodically throughout the day – we recommend that you leave it on for constant air cleaning while you are using the room– after all, air pollution never takes a break- why should your air cleaner?

We have found that many people start with one air cleaning system and move it from room to room throughout the day. You should focus your air cleaning efforts in the area where you and your family spend the most time. Some of them continue the practice of moving the air cleaner from room to room – others purchase additional units. How you end up using your system or systems, you need to remember this one thing...

For optimal performance, keep these 3 things in mind:

1. Position the air cleaning system at least 1 foot away from the wall. The more centrally the air cleaner is positioned, the better and faster air cleaner can purify the air.
2. Keep the power cord away from walk ways.
3. Make sure you can easily access the control panel.



CONNECTING TO POWER

After selecting the location for your air cleaning system, and clearing the space around where it will stay, connect the power cord to the unit and the other end into the socket.

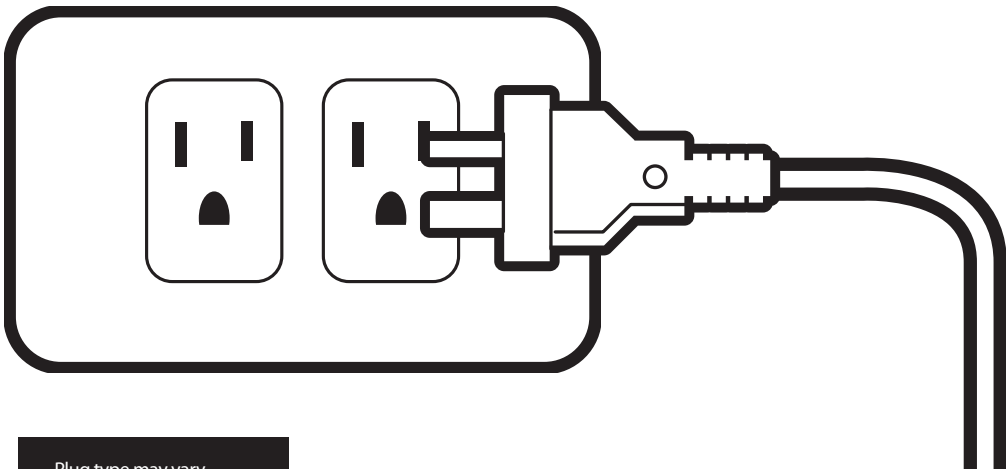

Plug type may vary

Make sure the cleaner is plugged into a live 110-120V AC outlet (or 220-240V AC outlet if you are located outside the United States and Canada).



AIRGLE® PUREPAL® COMPONENTS

PurePal® Components without Titanium Pro®
Showing 5 and 6 here
PurePal® Plus Components with Titanium Pro®
Showing 4, 5 and 6 here

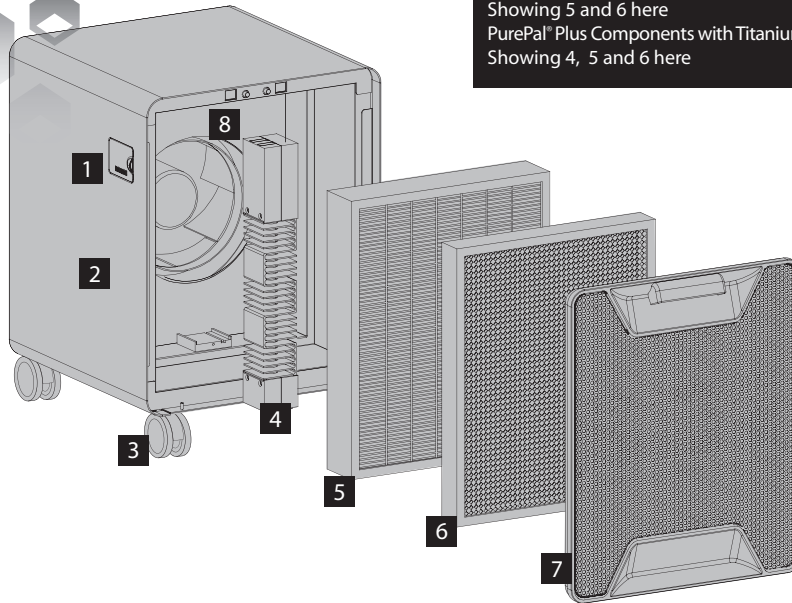

1. Sensor: Monitors the amount of particles in the room to determine airflow activity (if unit is on auto)
2. Housing: The outside “box” for the unit. You will want to make sure that this is kept clean and that no areas such as the sensor or air intake/outflow become covered or blocked.
3. Casters: Install the casters provided with your cleaning system to make it easier to move as needed when cleaning as well as to keep the unit off the floor for better airflow.
4. Titanium Pro®: This module is easily removed when replacement is required as indicated on the control panel. The light bulb indicator on the control panel will start blinking when the module has reached its life of 6000 hours and requires replacement. (AG850)
5. HEPAfast Filter: This filter is easily removed for replacement when indicated on control panel.
6. Gas & Odor Filter: This filter is removed for cleaning (by vacuum) or replacement. We recommend checking for possible cleaning every cleaning every two months. The filter may need replacement every two years depending on use.
7. Rear Door: Make sure that the rear door is latched on correctly so as not to overload the air cleaning system with additional air intake that is not entering the unit in the proper manner.
8. Auto Shut Off: This safety feature will automatically turn off the unit if the rear door is removed while the unit is running.



HOW THE AIRGLE® PUREPAL® SYSTEM WORKS

1. Room air is drawn into the system via the rear grill
2. The cleaning process starts when the air moves through the Gas & Odor filter. This filter captures large particles, and VOC that are adding to air pollution.
3. Next the air moves through the HEPAfast filter which captures tobacco smoke, dust mites, pollen, dander, smog, mold, and other airborne pollutants.
4. If your unit includes the Titanium Pro® Module, the air moves through this final filter where additional items such as mold, odors, and VOCs are filtered out and bacteria/virus organisms are killed.
5. Purified air is then returned to the room via the front grill.

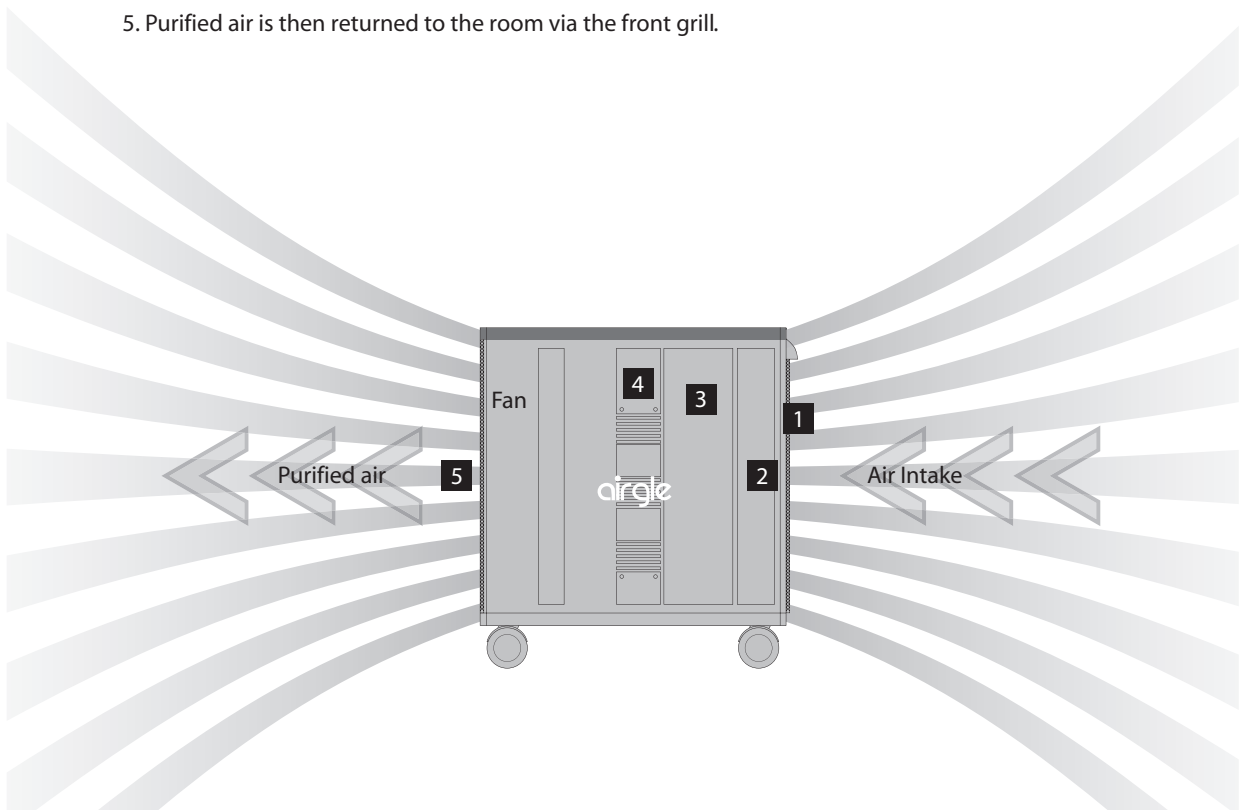



USING THE CONTROL PANEL

The Airgle® System is equipped with a state-of-the-art control panel. This advanced control panel allows you to see unit status with one quick glance.

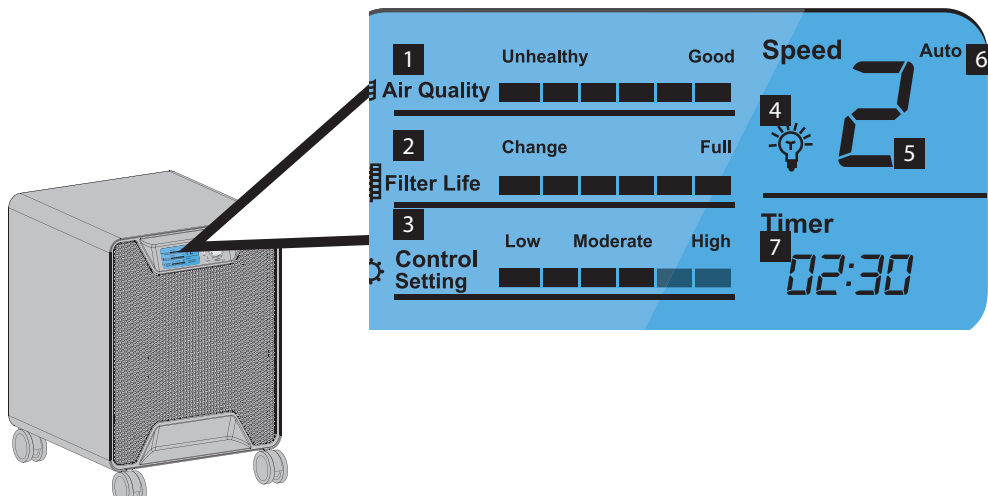
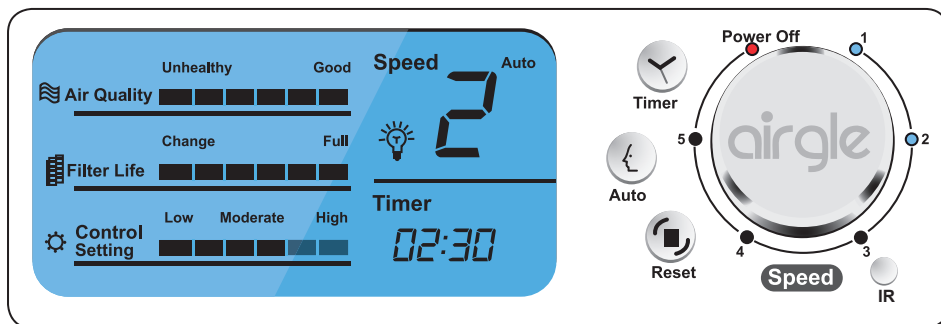

1. Air Quality: The Airgle® system is equipped with an advanced air quality monitoring sensor. The Air Quality Gauge displays the quality of the air in the room – the air you breathe. The 6 status bars indicate the quality from Unhealthy (1 bar) to Good (6 bars).



Unhealthy

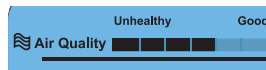

Moderate

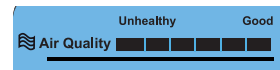

Good

2. Filter Life: This monitor calculates the remaining life of the system's filters. The calculation takes into account both the already elapsed operation time and fan speed. This allows for a more accurate report on filter life. The 6 status bars indicate if the filter should be changed (1 bar) to when it is at its full life (6 bars). When the filter needs attention, "the first bar" will be blinking.

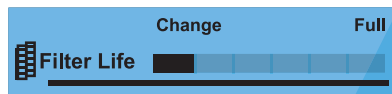

Change

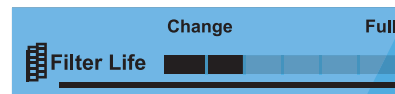

33% Remaining

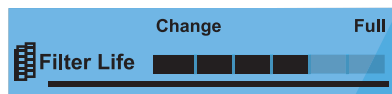

66% Remaining

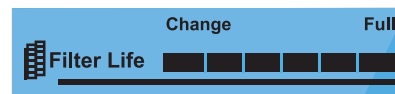

Full Life

3. Control Setting: This advanced setting is for users who encounter challenging air pollution environments and/or needs. The default setting is Moderate which should work for most users. For more information, see the Control Setting section in this manual.
4. Light Bulb: This indicator displays if you have installed Titanium Pro®. If blinking, indicates that the filter needs to be replaced. For more information, see the Titanium Pro® section in this manual.
5. Speed: This indicates the speed selected by using the knob on the right hand side of the panel.
6. Auto: This indicates if you have elected to use the Auto-Mode (selected using the button on the right side of the panel).
7. Timer: This indicates how much time is left until the system shuts down (activated by the Timer button on the right hand side of the panel).

Control Panel details: right hand side

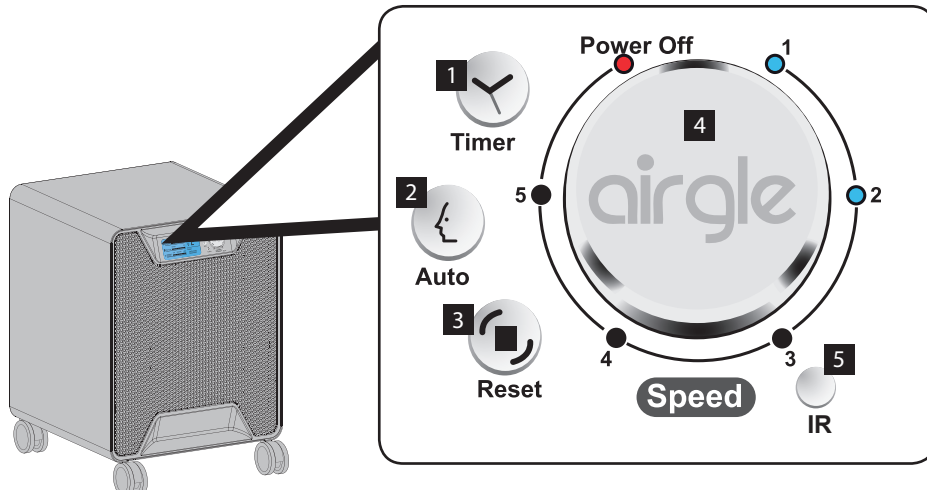

1. **Timer:** Press this button to set the timer for up to 12 hours of continuous operation. The time left displays on the left hand side of the panel.
2. **Auto:** When you select auto mode, your unit will automatically change to the optimum speed needed for air purification in the room. The sensor (located on the side of the unit) will tell the unit when to raise or lower fan speed depending on the amount of particles in the room.
Night Mode: If you wish the LCD on the left hand side of the panel to turn off, press the Auto button and hold down for 3 or more seconds to set the panel on Sleep mode. Press Auto button again and hold down for 3 or more seconds to turn the LCD back on.
3. **Reset:** Press this button after you have replaced any of the filters. This will reset any blinking lights and set filter life to full.
Note: This function is only activated when any of the filters require changing. If the filter life is full, the button is disabled to prevent the accidental press of the button.
4. **Power/Speed:** To turn the system on, rotate knob to select a speed from 1 to 5. The light indicator for the selected speed will display as blue and the speed you selected will display on the left hand side of the panel. To turn the system off, rotate the knob to the "power off" position. When the air purifier is turned off, the fan stops rotating.

5. IR: This infrared receiver is used by your remote control to change unit settings

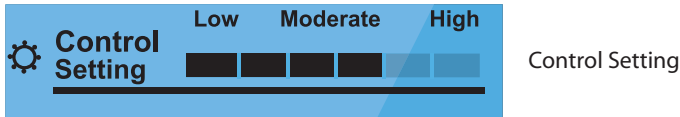

The default setting for the unit is moderate and will be displayed as 4 bars on the control panel. This setting should meet most needs.

For advanced users only:

1. Make sure that the unit is on Standby mode (plug in the unit, and confirm knob is at the "power off" position)
2. Press and hold "Auto" button for more than 5 seconds. You will hear a "ding" sound, the Control Setting bars will go from High, Moderate, Low, Moderate..... and then start blinking.
3. If you release "Auto" button when "High" is blinking, the system is set to High Mode.

Answer the following questions to see if you need to change your setting.

	Yes	No
Are you noticing severe indoor air pollution problems?	<input type="checkbox"/>	<input type="checkbox"/>
Are you or a member of your family having severe asthma and/or allergy issues?	<input type="checkbox"/>	<input type="checkbox"/>
Do you want to be able to always set your system to Auto* mode?	<input type="checkbox"/>	<input type="checkbox"/>

Auto Mode: Your system will start on high to purify the air until it senses an extremely low concentration of particles and then auto change itself to the low setting.

If you answered "Yes" to any of the questions above, you may want to consider changing your setting to "High". If you answered "No", answer the following question.

	Yes	No
Do you have a clean environment and purchased the unit for general air purification reasons?	<input type="checkbox"/>	<input type="checkbox"/>

If you answered "Yes" to this question, you may want to consider changing your setting to "Low".

What happens in High Mode?

When your unit is set on High, the sensor (on the side of the unit) is more sensitive to the environment. The system will auto-activate when it detects small amounts of particles in the air. And since it is more responsive to these small amounts of particles, it will activate frequently and this will shorten the life of the filter however air will be more pure in your room.

What happens in Low Mode?

When you unit is set on Low, The sensor (on the side of the unit) is less sensitive to the environment. The system does not auto-activate until it senses a medium to high amount of particles in the air. This setting extends the filter life.

Titanium Pro®

If you own an AG850, that unit includes the Titanium Pro® module.

If your unit has been installed with the Titanium Pro® module, the light bulb icon will display on your control panel. The light bulb serves to indicate if your unit has the module installed, but also indicates when it is time to replace the module by blinking.

The Titanium Pro® module is designed to last 6000 hours. When that time is up, the light bulb icon will start blinking. After you replace the filter, and you press the Reset button (right hand side of the panel), it will stop blinking.

If desired, the Titanium Pro® module can be turned off.

1. With the power turned off, press the Timer button and hold down for more than 5 seconds.
2. The light bulb indicator will start blinking
3. When the light bulb is on, press the Timer button again to turn on the Titanium Pro® module
4. When the light bulb is off, press the Timer button to turn off the Titanium Pro® module



USING THE REMOTE CONTROL

Use the remote control to:

1. Switch the system on/off
2. Change mode from manual to auto
3. Regulate fan speed
4. Set timer

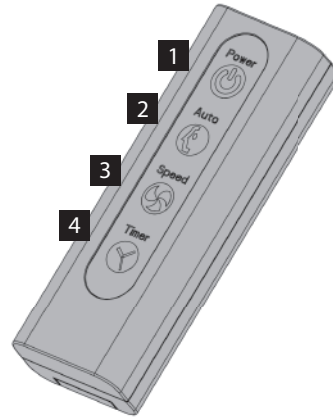

The infrared receiver of the Airgle® system is located in the right hand bottom corner of the control panel. In order to get the best signal transmission, the remote control should be pointed at the control panel when pressing any button on the remote.

Replacing the remote control battery

1. Open the battery compartment by pressing the small lever to the side and slide the battery compartment out.
2. Remove the used battery.
3. Insert the new battery (Lithium coin battery 3V). Be sure that the (+) and (-) are correct.

Note: Rechargeable batteries are not compatible with the remote control.

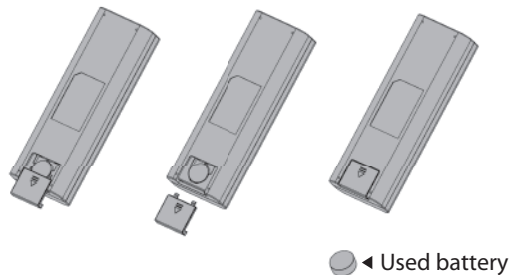



USER SERVICING INSTRUCTIONS OF YOUR PUREPAL® AIR CLEANING SYSTEM

Your PurePal® system is equipped with a filter life monitor which will assist you in determining when a filter needs to be replaced. If indicated, replace your filters.

Always turn off the air cleaner and unplug the power cord when doing any cleaning or maintenance tasks.

Filter Removal

Your PurePal® system provides access to all installed filters from the rear grill. Pull up the handle to remove the grill and access the filters.

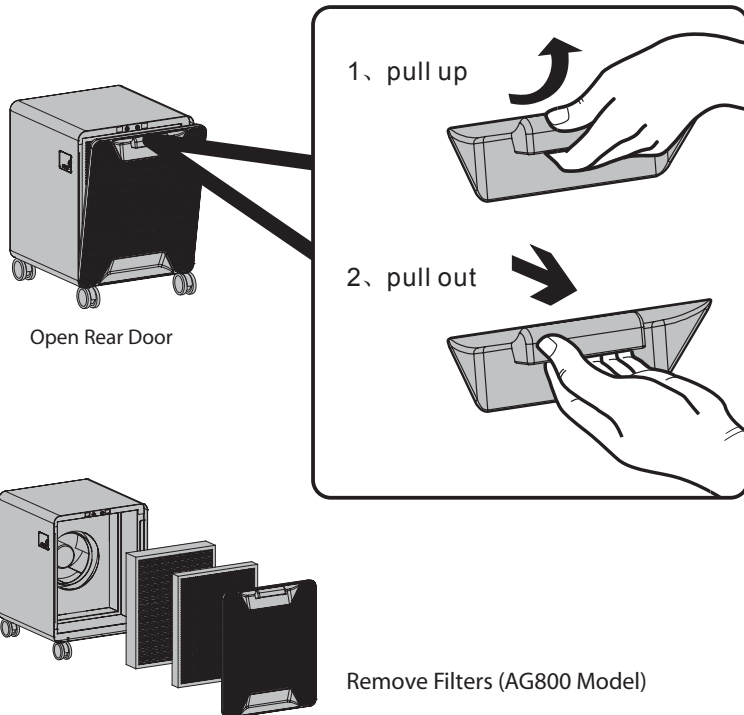

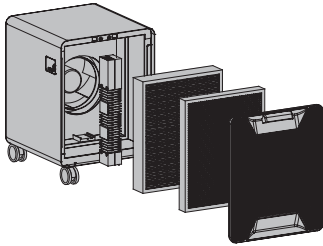

Remove Filters (AG850 Model)

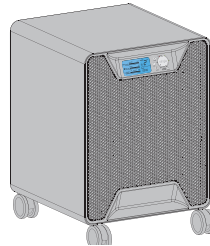

Replace all filters in reverse order of removal when done and make sure that the rear door is completely closed.

Cleaning the Gas & Odor Filter

The Gas & Odor filter is not monitored by the Filter Check system. The Gas & Odor Filter should be checked at least every two months to see if cleaning is necessary. Trapped particles in the filter build up and will block the airflow which then shortens the life of the HEPAfast filter. This will reduce the system effectiveness in cleaning the air in your room

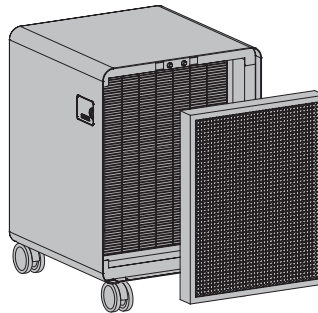

Replacing the HEPAfast filter

When the first bar on the Filter Life LCD is blinking, it means the HEPAfast filter needs replacement. Follow the instructions above to remove the dirty filter and install new ones. Press the "Reset" button on the Control Panel to reset the filter. The filter life gauge should reset to 6 full bars.

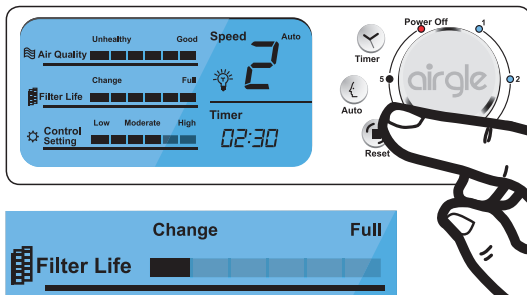

Replacing the Titanium Pro® module

When "Light bulb" sign on the control panel is blinking, it means the Titanium Pro® module needs replacement. Follow the instructions above to remove the used Titanium Pro® and install a new one. Press the "Reset" button on the Control Panel to reset. The "light bulb" will stop blinking.

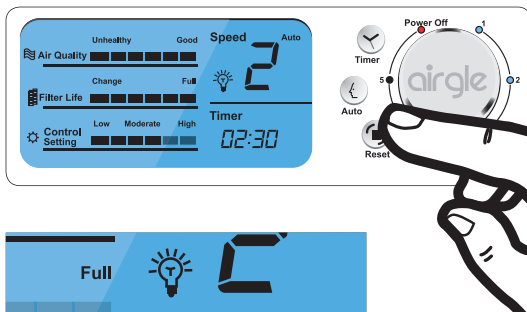

Cleaning the Housing and Sensor

Our unique Airgle® system design includes a rear door with a grill that acts as a filter for human hair and large particles. This helps the life of the Gas & Odor filter, the HEPAfast filter and the Titanium Pro® module (if installed). Use your vacuum to clean the grill on the rear door.

The sensor and housing can be cleaned, using lukewarm water and a small amount of detergent.

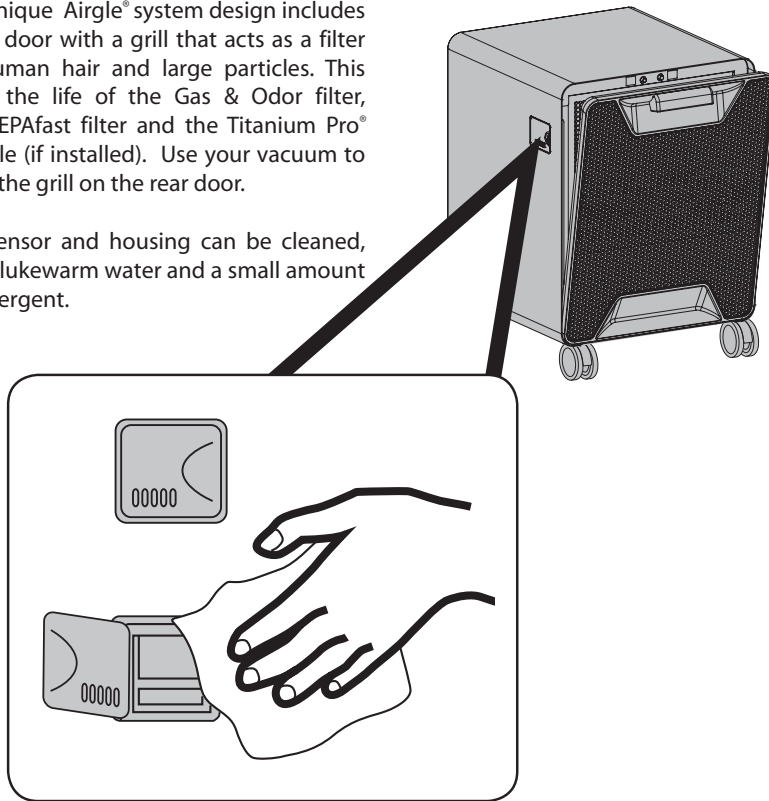

All other electronic components of the unit such as motor/fan are maintenance-free.



WARRANTY TIPS:

Airgle Corporation offers a Five Year Limited Warranty on the Airgle® PurePal® Series air cleaners. To activate your warranty, visit us on the web at www.Airgle.com/warranty

airgle®

Precisely Pure

AIRGLE CUSTOMER CARE

☎ (866) 777-1333

@ info@airgle.com

Free Manuals Download Website

<http://myh66.com>

<http://usermanuals.us>

<http://www.somanuals.com>

<http://www.4manuals.cc>

<http://www.manual-lib.com>

<http://www.404manual.com>

<http://www.luxmanual.com>

<http://aubethermostatmanual.com>

Golf course search by state

<http://golfingnear.com>

Email search by domain

<http://emailbydomain.com>

Auto manuals search

<http://auto.somanuals.com>

TV manuals search

<http://tv.somanuals.com>