

DV Camcorder

Quick Start Guide | ADVC01F



Introduction

Thank you for choosing Aluratek's® CINECAM DV Camcorder. In addition to making sure only quality materials are used for manufacturing, Aluratek® is also dedicated to provide the best customer satisfaction and support.

The goal of Aluratek is to embody **"Simple Elegance"** in every product it designs, manufactures and sells.

The product focus of Aluratek is to bring simple yet elegant connectivity solutions to the consumers to enhance their consumer electronics, communications and computing experience. Each product is carefully designed with the consumer in mind. Each product is solution-driven to address the need of the consumers and deliberately planned to provide the ultimate user experience.

Read this guide thoroughly and follow the installation and operation procedures carefully to prevent any damage to the unit and / or any of the devices it connects to.

Features and Requirements

Features:

- Easy to use, pocket-sized digital camcorder
- Simple user interface lets you start recording in seconds
- Convenient flip-out USB connector plugs directly into your computer to transfer your pictures and videos
- Convenient and fun way to easily upload your photos and videos to social networking sites such as *Facebook*, *MySpace* and *YouTube* etc.
- Expand the memory capacity up to 8GB with the SD card slot
- 5.0 Mega Pixels CMOS Sensor / 8x Digital Zoom
- Color LTPS 2.0" LCD display
- 16MB built-in flash memory
- 30 FPS@QVGA with sound / 25 FPS@VGA with sound
- 1 Year Warranty

Requirements:

- Windows XP(SP2) / Vista or later OR Mac 10.4.9 or later
- Available USB port

Package Contents

Your order has been carefully packaged and inspected. The following should be included in your package. Please inspect the contents of the package to ensure that you have received all items and that nothing has been damaged. If you discover a problem, please contact us immediately for assistance.

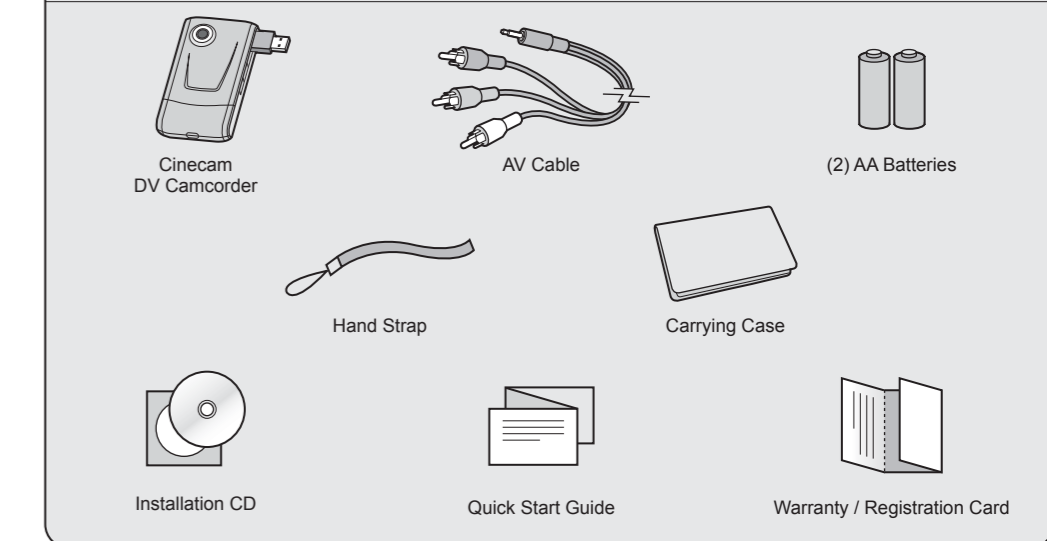

qsg Q10120 Copyright © 2009 Aluratek, Inc. All Rights Reserved.

aluratek.com

Highlights and Application

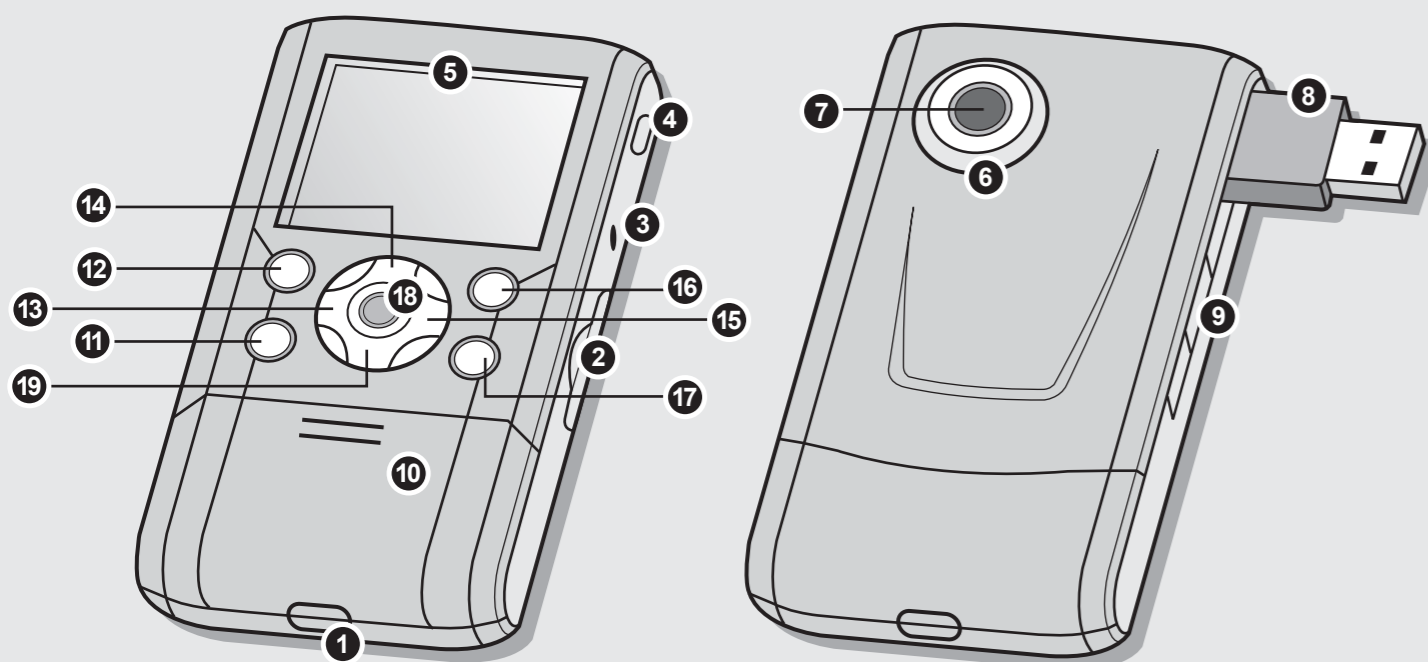

1	Strap hook	Hook for attaching the wrist strap to the camera.
2	SD card slot	SD card slot.
3	AV port	For television connection.
4	Macro switch	▲ Normal mode : photographs from 0.5m - infinity. ▼ Macro mode : close-up photographs (11cm - 18cm).
5	LCD screen	Display photographs, video clips, camera setting and menu.
6	Microphone	For voice input.
7	Lens	Records the image to be taken. <i>Note: Keep the lens clean. Dirt and fingerprints will affect the quality of the picture.</i>
8	USB interface	Download photographs and video clips to a computer.
9	USB switch	Slide it to pop-up the USB interface.
10	Battery door	2xAA alkaline batteries.
11	Delete	Press it to delete the photo or video clip in playback mode.
12	Mode	Press it to select different mode/Press and hold it to enter setting menu.
13	Left	For LEFT selection in menu mode.
14	UP	For UP selection. Digital zoom in.
15	Right	For Right selection in menu mode.
16	Power on / off	Press this button to turn on, press again to turn off.
17	Speaker	Speaker.
18	REC	Press this button to take photographs, start/stop recording a video clip or to confirm changes in menu mode.
19	Down	For Down selection in menu mode. Digital zoom out.

Status Icons

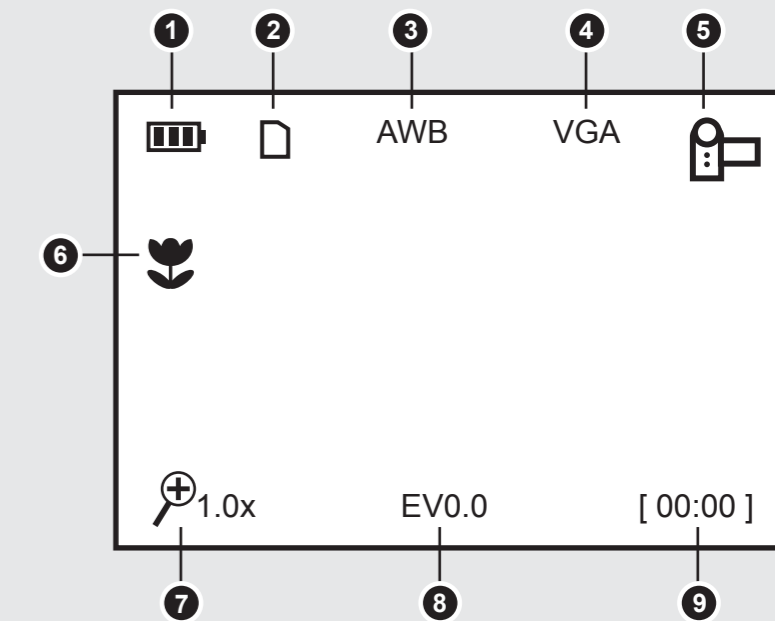

Camera Settings

Quality setup	Super Fine (Default) / Fine / Normal	Picture quality set-up
Image Size	12M pixel resolution	3920 x 2940
	8.0M pixel resolution	3264 x 2448
	5.0M pixel resolution	2560 x 1920
	3.1M pixel resolution	2048 x 1536
	1.3M pixel resolution	1280 x 960
	VGA resolution	640 x 480
White Balance	Auto (Default)	Automatic white balance
	Sunny	Select for daylight surrounding
	Cloudy	Select for cloudy surrounding
	Fluorescent	Select for fluorescent surrounding
	Tungsten	Select for tungsten lighting
EV setup	0.0,+/-0.3, +/-0.7, +/-1.0, +/-1.3, +/-1.7, +/-2.0	Level of exposure
Stamp	Off (Default) / Set	DD, MM, YYYY

Camcorder Settings

Movie Size	VGA	640 x 480
	QVGA	320 x 240
White Balance	Auto (Default)	Automatic white balance
	Sunny	Select for daylight surrounding
	Cloudy	Select for cloudy surrounding
	Fluorescent	Select for fluorescent surrounding
	Tungsten	Select for tungsten lighting
EV setup	0.0,+/-0.3, +/-0.7, +/-1.0, +/-1.3, +/-1.7, +/-2.0	Level of exposure

Setup Settings

Auto off	1min / 3min / Off	Auto power off in 1min, 3min(default) if no operation or Off
Beep	On / Off	Turn On / Off the beep sound
Brightness	0.0,+/-2.0, +/-1.0,	
Display setup	NTSC	American & Japanese video format
	PAL	European video format
Format	Yes/No	Format the memory card
Date/Time	YYYY / MM / DD	Date and Time setting
Flicker	50Hz	Main European electricity frequency
	60Hz	Main American electricity frequency
Default setup	Yes / No	Restore to default setting
Language	English (Default) / T-Chinese / S-Chinese / French / Deutsch / Italian / Spanish / Portuguese / Japanese	Select display language

Operating Instructions

STEP 1. Installing the Battery:

1. Open the battery door.
2. Insert (2) AA alkaline batteries into the camera.
3. Power on / off by holding  for 3 seconds.

STEP 2. Inserting a Memory Card (not included)

ADVC01F has a very small amount (16MB) of built-in memory. It is highly recommended to increase the memory capacity with a SD or SDHC memory card (not included). Follow the instructions below to insert the optional SD / SDHC memory card into the camera.

1. Turn off the camera.
2. Insert the SD card into the camera.

Note: There is only one correct direction to insert the SD memory card into the slot. Do not force the card into the slot, or else it may damage both the camera and the SD memory card.

Note: Most memory cards come pre formatted. If your memory card is not formatted, please follow these simple procedures.

Formatting the Memory or SD Card:

Warning: Formatting will erase everything on the card





1. Press and hold Mode button to enter setting menu;
2. Select Setup mode by navigation keys and press REC to confirm;
3. Select Format by navigation keys and press REC to confirm;
4. Press REC to format the card or memory.

Setting the Resolution:

ADVC01F can be set to different resolutions.

1. Press and hold Mode button to enter setting menu;
2. Select Resolution by navigation keys and press REC to confirm;
3. Different resolutions will be displayed. Select the desired resolution by navigation keys and press REC to confirm the selection.

STEP 3. Taking Video or Photographs:

1. Power on ADVC01F.
2. Press Mode to set ADVC01F to photo mode () or video mode ().
3. Depending on the distance to the object being photographed, use Macro switch to adjust the distance. Select the flower symbol () to take a close up photograph (11cm –18cm). To take video or photograph of surroundings or people (0.5m - infinity), set the Macro switch to Normal mode ().
4. Use the LCD screen to aim the object you wish to take video or photograph.
5. Press REC button.





Caution: 1) Taking picture for fast-moving object is not recommended.
2) Image may be distorted when taking picture in a moving vehicle.

Zoom IN and OUT:



ADVC01F has **8X** zoom.
Zoom in or out by pressing the  or  button, a number will appear on the display. 8.0x is the maximum zoom.

STEP 4. Playback Photographs / Videos Clips :

Photographs Playback :

1. Press Mode button to enter Playback mode, use  or  keys to select the desired video clip or photo.
2. Press  or  to zoom in or out the image.

Video Clips Playback:

1. When video clips are displayed, press REC to play, and press again to pause;
2. Press  or  keys for fast forward or backward;
3. Press Mode to exit.

STEP 5. Delete Photographs and Video Clips:

1. Press MODE to select Playback mode.
2. Press and hold MODE button to enter Delete mode.
3. Select single or all then press REC to confirm.

Note: you can also press Delete button to delete photograph or video clips in playback mode.

Specifications

Sensor		5.0 Mega pixel CMOS sensor
Image resolution	DV	VGA (640x480) / QVGA (320x240)
	DC	12.0 Mega pixels: (3920x2940) (Hardware Interpolation)
		8.0 Mega pixels: (3264x2448) (Hardware Interpolation)
		5.0 Mega pixels: (2560x1920)
		3.1 Mega pixels: (2048x1536)
		1.3 Mega pixels: (1280x960)
		VGA: (640x480)
Lens		F/2.8 f=8.5mm
Focus range		0.5m. ~ Infinity
Macro mode		11cm – 18cm
Digital zoom		8x
LCD display		2.0" real color LTPS TFT
White balance		Auto /Sunny / Cloudy / Fluorescent / Tungsten
Built-in memory		16 MB Flash memory
External memory card		SD card supports up to 8GB
File format		Picture: JPEG, Video: AVI,
PC interface / TV-out		USB 1.1 / NTSC, PAL
Power source		2xAA alkaline batteries. (rechargeable batteries not recommended)

Connect to TV

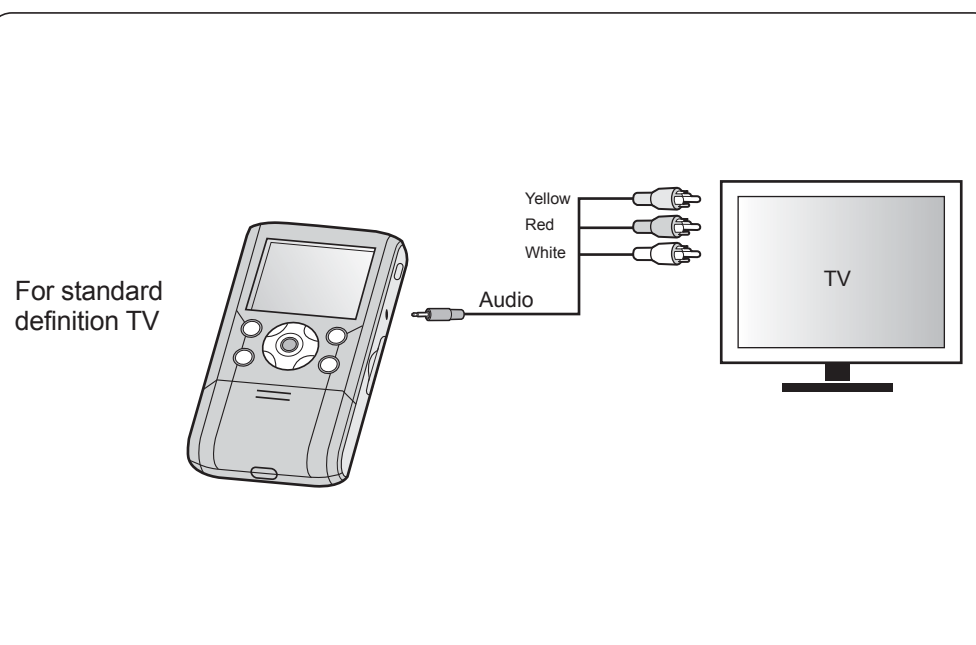

Connect to Computer

Software Installation:

1. Insert CD to your computer.
2. Select "Install Medialmpression"
3. Follow the onscreen instruction to install the software.

Connect to computer:

1. Power on ADVC01F
2. Slide the USB switch to open the USB connector
3. Connect ADVC01F to the USB port on your computer
4. ADVC01F will appear on your computer as a "Removable Drive" in "My Computer"
5. You can manage your pictures/videos using the Medialmpression software or click on the "Removable Drive" directly.

How to upload to Youtube from Medialmpression:

1. Select the video that you like to upload
2. Click on the YouTube icon in menu bar
3. Complete your YouTube account information

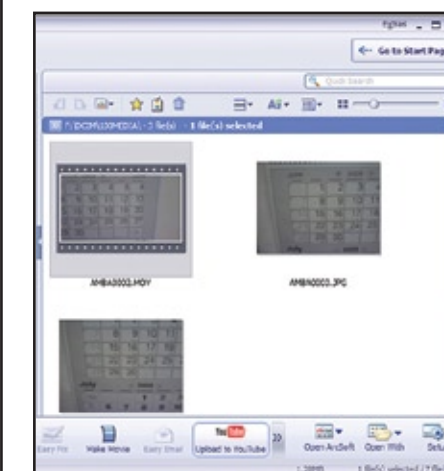

4. Fill in the video info and click "Upload"

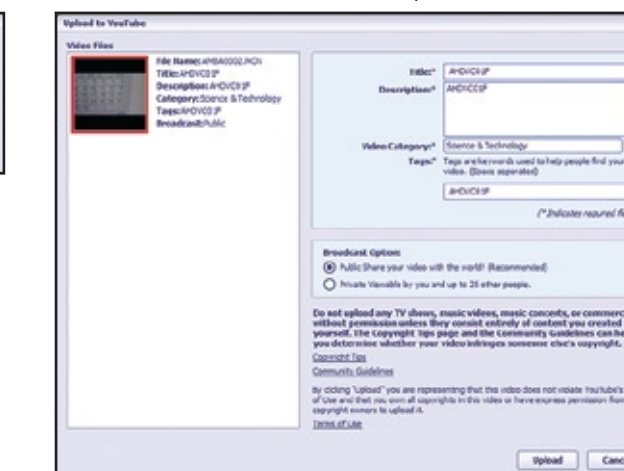

Troubleshooting

Problem	Cause	Solution
Can not power on the unit	Low battery power. Battery placed at wrong polarities.	Replace or install the battery correctly.
Photos can not be saved when taking pictures.	The memory card hasn't been formatted correctly or memory is full.	If the memory is full, use a different memory card. Format the memory card if it was not formatted. Warning: Format will erase everything on the card.
Can not find removable disk after connecting the camera to the computer.	Connection failure.	Make sure all cable connections are secured and restart the computer if necessary.
Photos are blurry	1. ADVC01F is not held steadily 2. ADVC01F lens is dirty. 3. ADVC01F is set to the wrong focus mode.	1. Hold ADVC01F steadily until it beeps when taking video photo. 2. Clean the lens with soft dry cloth. 3. Set the macro/normal mode according to the distances of subject.

If you need further assistance, please contact the Aluratek support department for troubleshooting prior to returning this device.

E-mail: support@aluratek.com

Local (Irvine, CA): **949-419-6504**

Web: www.aluratek.com/support

Toll free: **1-866-580-1978**

Radio and TV Interference Statement

WARNING!!! This equipment has been tested and found to comply with the limits of a Class B digital device, pursuant to part 15 of the FCC rules. These limits are designed to provide reasonable protection against harmful interference in a residential installation.

This equipment generates, uses and can radiate radio frequency energy and, if not installed and used in accordance with the instruction, may cause harmful interference to radio communications. However, there is no guarantee that interference will not occur in a particular installation. If this equipment does cause harmful interference to radio or television reception, which can be determined by turning the equipment off and on, the user is encouraged to try to correct the interference by whatever measures may be required to correct the interference.

Warranty

Aluratek warrants this product against defect in material or workmanship for **1 Year** from the date of purchase.

This warranty becomes invalid if the factory-supplied serial number or "warranty void" sticker has been removed or altered on the product.

This warranty does not cover:

- A) Cosmetic damage or damage due to acts of God
- B) Accident, misuse, abuse, negligence or modification of any part of the product.
- C) Damage due to improper operation or maintenance, connection to improper equipment, or attempted repair by anyone other than Aluratek.
- D) Products sold AS IS or WITH FAULTS.

IN NO EVENT SHALL ALURATEK'S LIABILITY EXCEED THE PRICE PAID FOR THE PRODUCT FROM DIRECT, INDIRECT, SPECIAL, INCIDENTAL, OR CONSEQUENTIAL DAMAGES RESULTING FROM THE USE OF THE PRODUCT, IT'S ACCOMPANYING SOFTWARE, OR IT'S DOCUMENTATION.

Aluratek makes no warranty or representation, expressed, implied, or statutory, with respect to it's products, contents or use of this documentation and all accompanying software, and specifically disclaims it's quality, performance, merchantability, or fitness for any particular purpose. Aluratek reserves the right to revise or update it's product, software or documentation without obligation to notify any individual or entity.

Free Manuals Download Website

<http://myh66.com>

<http://usermanuals.us>

<http://www.somanuals.com>

<http://www.4manuals.cc>

<http://www.manual-lib.com>

<http://www.404manual.com>

<http://www.luxmanual.com>

<http://aubethermostatmanual.com>

Golf course search by state

<http://golfingnear.com>

Email search by domain

<http://emailbydomain.com>

Auto manuals search

<http://auto.somanuals.com>

TV manuals search

<http://tv.somanuals.com>