



## Owner's Manual

# *Plasma 12000*<sup>TM</sup> BTU

## Portable Air Conditioner

Model PVMB-I2000E



It is important that you read these instructions before using your new purchase and we strongly recommend that you keep them in a safe place for future reference.

**Innovative AutoDrain NanoMist Technology<sup>TM</sup>**

Patent Pending



# Table of Contents

THANK YOU .....	2
Energy Saving Tips .....	2
SPECIFICATIONS .....	3
BEFORE USE .....	4
THE PVMB UNIT / PARTS .....	5
AUTODRAIN NANOMIST TECHNOLOGY™ ASSEMBLY .....	6
INSTALLATION OF THE WINDOW KIT .....	7
Window Kit Installation .....	7
INSTALLATION .....	8
OPERATION .....	9
Turning the Unit On .....	9
Setting the Clock .....	9
Setting the Temperature .....	9
Mode Button .....	9
Fan Speed .....	9
To Set the Timer .....	9
Canceling the Timer Function .....	11
Sleep Mode .....	11
REMOTE CONTROL .....	12
EMPTYING THE INTERNAL WATER CONTAINER .....	13
MAINTENANCE .....	14
Cleaning the Unit.....	14
Cleaning the Filter .....	14
End of Season Storage.....	14
TROUBLESHOOTING .....	15
WARRANTY .....	18

# Thank You!

Thank you for purchasing an AMCOR Portable Air Conditioner. AMCOR is a leading brand in indoor air treatment. We would like you to enjoy the many benefits this unit offers, so please read this manual carefully and take full advantage of the many advanced features that your AMCOR Portable Air Conditioner offers you.

AMCOR has specialized in complete indoor environment control, manufacturing world-class air conditioners, dehumidifiers and air purifiers with innovative technology.

In designing these advanced products, we have listened carefully to our customers and have passed their views on to our research and development laboratories.

We wish you many years of enjoyable use.

After reading this manual, please keep it in a safe place for future reference.

## **Energy Saving Tips**

- Do not locate the air conditioner where furniture or other objects can obstruct the airflow.
- Keep doors closed so cool air does not escape.
- Keep the filters clean.

Set the unit to maximum cooling and high speed fan initially, then adjust the unit to a comfortable setting.

**NOTE: Use the Temperature Control (UP/DOWN) to adjust Air Conditioner cooling to a desired level.**

# Specifications

<b>Model</b>	<b>PVMB-12000E</b>
Cooling Capacity	12,000 BTU/h
Cooling Power Consumption	1,100 W / 9.8 A
Power Supply	115V / 60Hz / 1 Phase
Dehumidification	80 pints / Day
Recommended room size	Up to 400 sq. ft.
Refrigerant	R-22
Compressor	Rotary
Fan Speeds	3 (2 + 1 Turbo)
Thermostat	64° - 90° F
Timer	0-24 hours
Dimensions	20"W x 16"D x 33"H
Weight	75 lbs.
<b>REMARKS:</b> The cooling capacity of the unit may be affected by the height of the ceiling, quality of insulation, number of windows, etc. Subject to modifications without prior notice. Please refer to the rating label for greater precision.	

# Before Use

## IMPORTANT!

- Leave the unit in an upright position for at least 2 hours before use.
- Always place the unit on an even surface.
- The power cord has a built-in L.C.D.I. (Leakage Current Detection and Interruption) circuit breaker for added safety. If the power supply is interrupted, please press the reset button to reconnect the unit to the power source. The green light should be on.
- Make sure the unit is connected to a correctly grounded power supply.
- **For proper operation, the unit must be vented to the outside.**
- Do not cover or obstruct the appliance inlet or outlet grilles.
- To avoid the risk of shock, the product should never be used in bathrooms, shower rooms or in any other steamy or wet areas.
- Always transport the unit in an upright position.
- Do not sit or stand on the unit.
- Do not place objects on the unit.
- Do not touch the unit with wet/damp hands or when standing barefoot.
- **Drainage of the water container is required before moving the unit or putting it into storage.**
- If the electric socket is different from the plug provided, have a professionally qualified electrician replace the outlet with a suitable one. Avoid the use of adaptor plugs, multiple sockets and/or extension cords; if their use is necessary, ensure that they conform to the current safety regulations.
- Do not pull the power cord or place it near a source of heat; always unroll it completely to avoid the possibility of dangerous overheating.
- If the power cord is damaged, it must be replaced by a qualified person.

THE MANUFACTURER DISCLAIMS ANY RESPONSIBILITY IF THE ABOVE INSTRUCTIONS ARE NOT FOLLOWED.

# The PVMB Unit

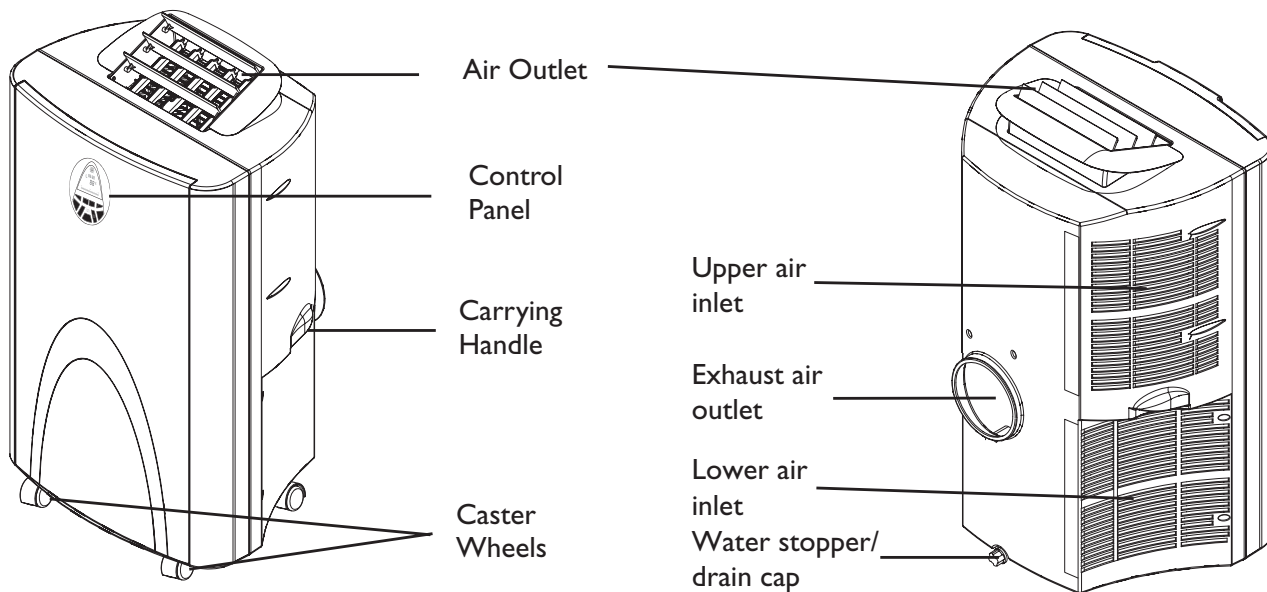

## Parts

### Air Filter (Pre-installed)

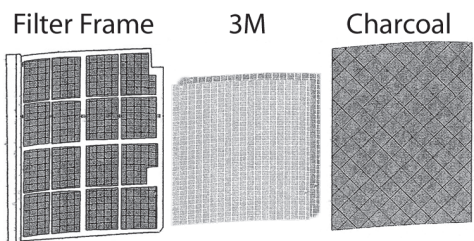

With Permanent Washable Filter



Remote Control

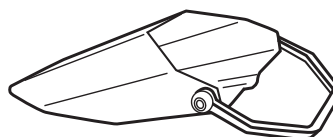

Drain Pan

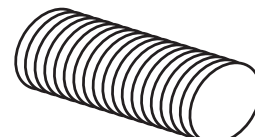

Exhaust Hose

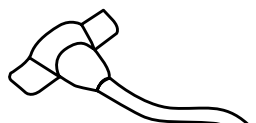

Spiral Water Pipe with Connector



Insulation Strips

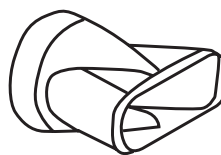

Slide Bar Connector

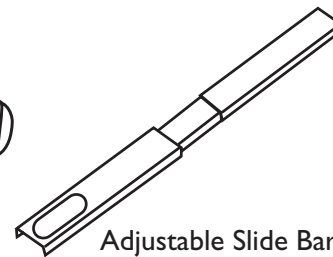

Adjustable Slide Bar

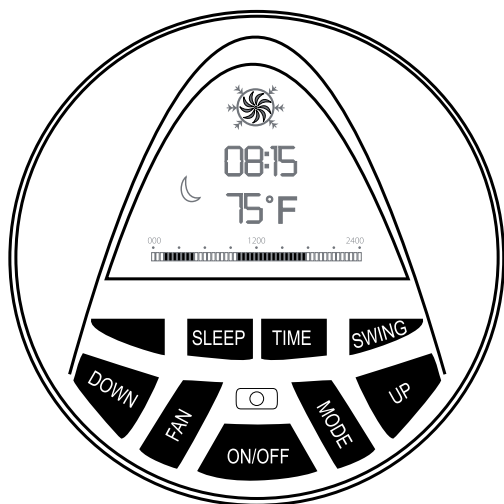

### Display



COOLING



FAN



SLEEP

08:15

HOURS: MINUTES

75°F

TEMPERATURE

# AutoDrain NanoMist Technology™ Assembly

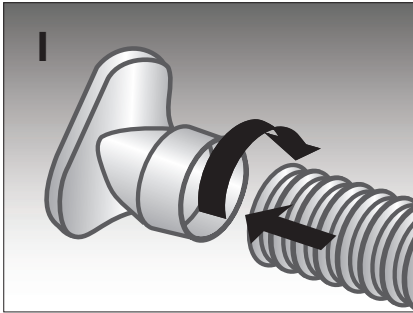

1 Attach Window Slide Bar Connector to Exhaust Hose by twisting as shown.

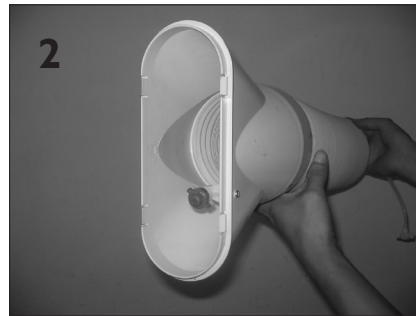

2 Put spiral water pipe into hot air flexible hose.

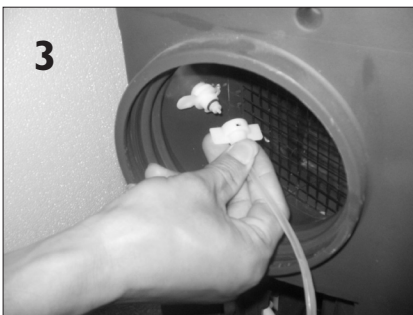

3 Connect the female half of the quick connector at the end of the spiral water pipe to the male part in the hot air outlet pipe.



4 Turn the connector 90 degrees clockwise until it is locked in place.



5 Assemble the hot air hose on the unit.

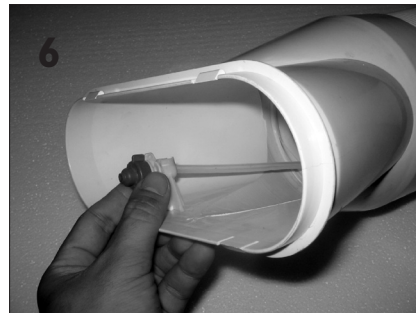

6 Clip on the water atomizer at the end of the spiral pipe to the holder.

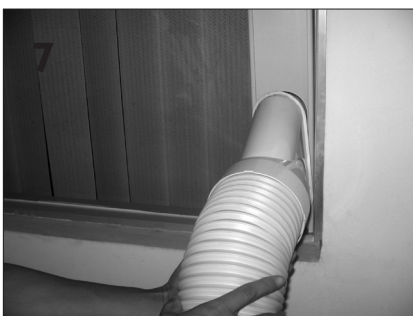

7 Unfold flexible hose with attached hose adapter connector, and snap into Window Slide Bar.



**Only Required For Disassembly.**

In order to unlock the quick connector, push the tab and turn the connector 90 degrees counter-clockwise.



# Installation of the Window Kit

**In order for this unit to function properly, it must be vented to the outside.**

Fitting the Exhaust Hose through a window is easy. Please see below.

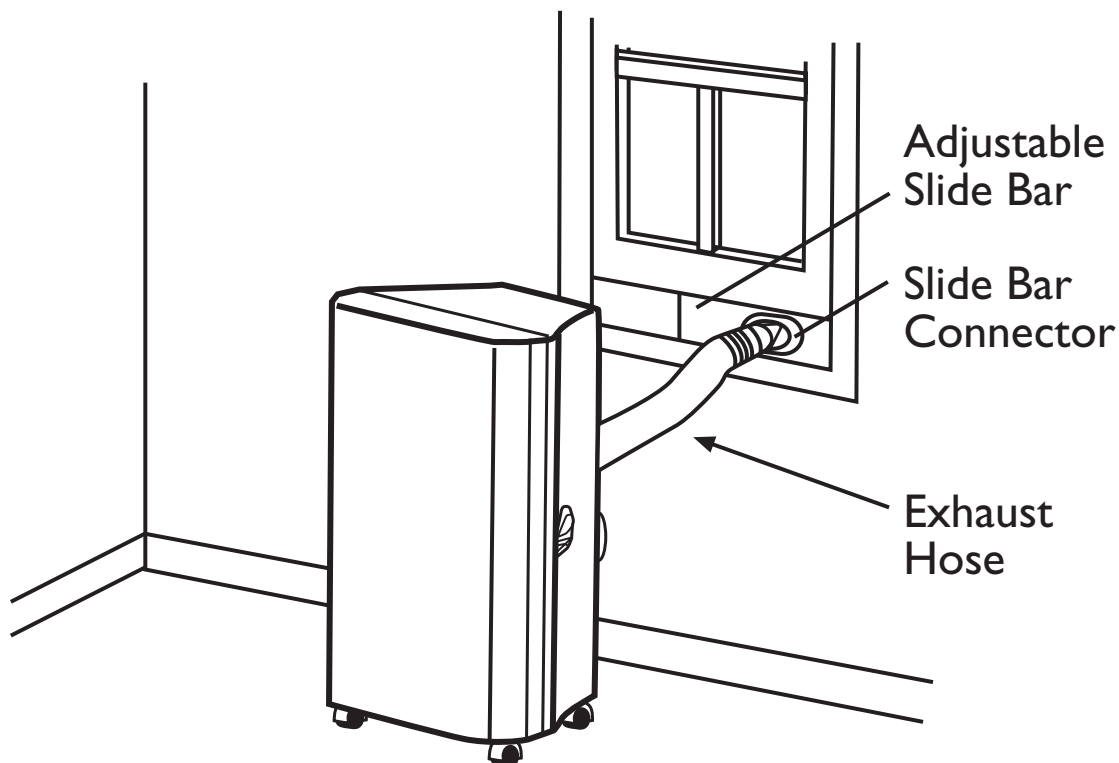

## **Window Kit Installation:**

1. Extend Exhaust Hose at least 6" and insert it into back of the unit, tightening into place by turning it clockwise.
2. Attach Slide Bar Connector to the other end of the Hose by extending hose at least 6". Then tighten Hose by turning the Slide Bar Connector clockwise.
3. Place Adjustable Slide Bar in the window and expand so it fits tightly.
4. Mark Slide Bar to record width of the window.
5. Apply Insulation Strips on top and bottom of Slide Bar.
6. Reposition Slide Bar Connector in the window. Expand the Slide Bar to fit tight. Tighten the screws.
7. Lower the window.
8. Make sure Hose has no kinks.

**Slide Bar has 3 sections which allows installation in windows up to 48" in width.**

# Installation

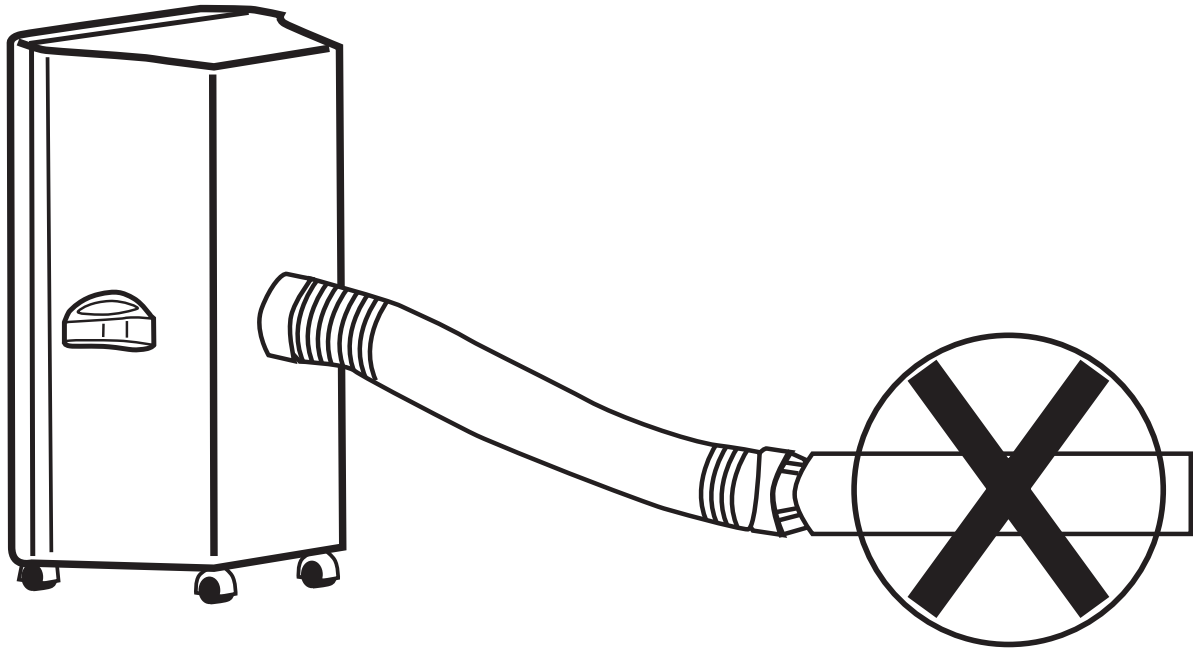

**WARNING!**

The length of the exhaust pipe is specially designed according to the specification of this product.

Do not extend it with your own hose, as this could cause the unit to malfunction

# Operation

**IMPORTANT:** The air conditioner should be left in an upright position for at least two hours

## A. Turning the Unit On:

1. Plug the unit into a working electrical outlet.
2. Make sure the green light on the plug is on.  
(If not, press the Reset button.)
3. Press the unit's ON/OFF Button on the LCD display.  
It may take a few minutes before cold air is dispersed.
4. Adjust FAN Speed by pressing the FAN Button until the preferred fan speed is reached.
5. Press the TIME Button to Set.

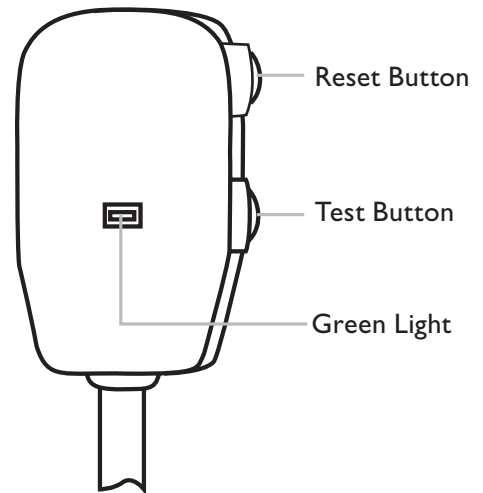

## B. Setting the TIME:

1. Press the TIME button for 3 seconds to set the clock. The hour digits will flash.
2. Press UP or DOWN to adjust the hour.
3. Press the TIME button, the minute digits will flash.
4. Press UP or DOWN to adjust the minutes.
5. Press the TIME Button to Set.

## C. Setting the Temperature:

To change the set temperature press the Up/Down button.

The 2 digit display will indicate the set temperature.

NOTE: Reaching the set temperature depends on the room and outdoor climatic conditions. The set temperature range is 64°F to 90°F.

## D. Mode Button:

Press the Mode Button repeatedly until the icon representing the desired mode is displayed (Cool or Fan). On the LCD-display you will see:

Cooling ❄️      Fan only 🌀

All settings will remain in memory unless power to the unit is shut off. At re-start unit will revert back to default temperature setting of 72°F.

## E. Fan Speed:

To select the desired fan speed, press the fan button. Options are Slow, Medium, and Turbo.

# Operation

## Timer

The TIMER function allows you to program the time the unit turns on and turns off.

### TO SET THE TIMER:

- Press the TIME button briefly, the 2 hour digits will flash.
- Press the UP or DOWN button to adjust the hour.
- Press the TIME button again. The 2 minute digits will flash.
- Press the UP or DOWN button briefly to adjust the minutes.
- The TIME is set. After 10 seconds the time display returns.

### Programming the Timer for ON:

- Perform the standard steps as described above. The linear time scale will be on between the ON programmed times until 24:00. The flashing bar on the time scale indicates the real time and moves a segment ahead every 30 minutes until it reaches the ON timer time, then the black segments in the linear time scale will disappear.

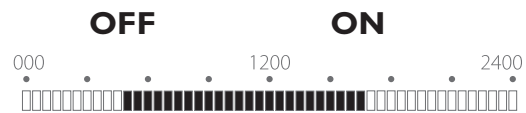

Timer Example

### Programming the Timer for OFF:

- Perform the standard steps as described above. The linear time scale will be on between the present time to the OFF programmed time. The flashing bar on the time scale indicates the real time and moves a segment ahead every 30 minutes until it reaches the OFF timer time, then the black segments in the linear time scale will disappear.

# Operation

The unit will operate daily according to the timer setting, unless changed.

After a power failure, or after the unit has been unplugged, you will have to program the timer settings again.

## Canceling the Timer Setting

In order to cancel the timer programming press the TIME button.

## Sleep Mode

The SLEEP MODE gradually adjusts the temperature of the unit 4 degrees upward, over a 3 hour period, to meet the needs of a body at rest.

To activate the SLEEP MODE:

- Ensure the unit is operating in Cool Mode.
- Set the desired starting temperature.
- Press SLEEP MODE button.
- In sleep mode fan will operate in low speed.
- To cancel this function press SLEEP MODE button again.

## Shutting Off the Blue Light on Control Panel

Normally there is a blue light on the LCD display.

To shut it off, press the UP and DOWN push buttons at the same time.

The blue backlight will blink twice, and after 3 seconds, will go off.

Pressing any of the push buttons will re-light the blue backlight.

## Auto Grill Function

1. When unit is being connected (plugged in) to the electricity the louvers open and close (and stay closed).
2. When the ON button is pressed, the louvers open to the maximum and return to an angle of 75° above the upper plane of the louvers housing (AUTO GRILL).
3. When the swing push button is pressed, the louvers swing up & down between 30° and 80° above the upper plane of the louvers housing (SWING).
4. When the louvers are moving in the swing function, by pressing the swing push button, the louvers stop moving and remain in the same position (SWING). This enables the user to direct the airflow vertically via the remote control.
5. When the OFF push button is pressed, the louvers close (AUTO GRILL).

# Remote Control

## To Operate the Remote Control:

Insert batteries by pulling down on front cover (See fig. 1).  
Be sure the remote is pointed at the unit at all times.

### 1. To Set the Clock:

- Press the TIME button for 3 seconds.
- The hour digits will flash. Press UP or DOWN to adjust the hour.
- Press the TIME button. The minute digits will flash. Press UP or DOWN to adjust the minutes.
- Press the TIME button when finished.

### 2. To Turn Unit ON:

- Press the ON / OFF button

### 3. To Adjust TEMPERATURE:

- Adjust temperature using the UP / DOWN buttons

### 4. To Adjust FAN SPEED:

- Press FAN button to select speed.

### 5. To Set the TIMER:

#### A. SET START TIME

- Press timer ON button and set the On hour using the UP and DOWN buttons.
- Press timer ON button and set the minutes using the UP and DOWN buttons.
- Press timer ON to finish.

#### B. SET OFF TIME

- Press the timer OFF button and set the Off hour using the UP and DOWN button.
- Press the timer OFF button and set the minutes using the UP and DOWN buttons.
- Press timer OFF to finish.

### 6. To Set SLEEP MODE:

- Make certain unit is operating in Cool Mode.
- Set the desired starting temperature.
- Press SLEEP MODE button.

### 7. To set Auto Grill Mode:

- Press the SWING button for moving louvers
- Press the SWING button again to stop louvers from moving

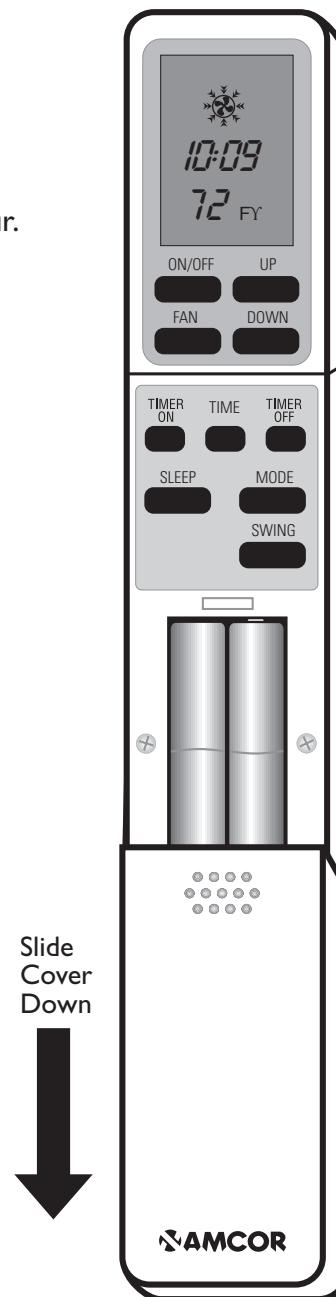

fig. 1

# Emptying the Internal Water Container

Note: There are two instances where draining the internal water container may be recommended:

1. In the unlikely event that the Container Full Light on the LCD display flashes
2. Prior to storage of unit.

**When the internal water container is full, the back light on the LCD display flashes. The unit will shut off automatically, and must be drained before it will restart.**

## To Drain the Unit:

- Switch off the unit and remove the plug from the wall socket.
- **DO NOT MOVE THE UNIT.** Doing this can result in water leakage, damaging your floor or carpet.
- Place the drain pan on the floor under the drain cap.
- Remove the drain cap and the rubber stopper from the drain, and let the water run out. Partially fill the drain pan, replace the rubber stopper, and empty the drain pan. This procedure must be repeated until the unit is empty.
- Replace the rubber stopper and drain cap. Put plug into the wall socket, and switch the unit on. The warning signal should be off.

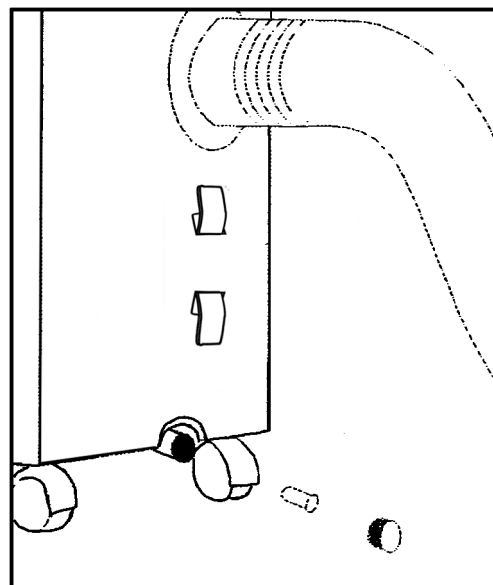

# Maintenance

**Always unplug the unit from the wall before performing any maintenance.**

- Make sure the unit is drained before moving.

## Cleaning the Unit:

- Only use a soft damp cloth.
- Never use chemicals, oil-based products, detergents, or other cleaning solutions. These could damage the cabinet.

## Cleaning the Upper Filter:

- Slide out the filter holder from the unit.
- Separate the filter fixer from the filter holder (see fig. 1).
- Remove the active carbon filter (black) and slide out the 3M™ High Air Flow filter (white).
- To clean filters, vacuum with standard vacuum cleaner.
- Insert the active carbon filter into the filter holder (see fig. 2).
- Insert the 3M™ High Air Flow filter into the filter holder (see fig. 3).
- Fix the filters by reassembling the fixer into the filter holder (see fig. 4).

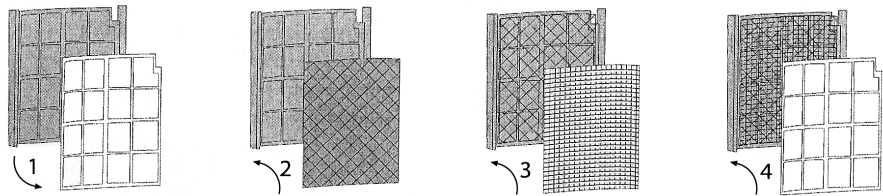

## Cleaning the Lower Filter:

- Vacuum with standard vacuum cleaner.

## NOTE:

- Before storage be sure filters are clean and dry.
- Should you need to replace filters, contact Amcor for replacement.
- The screen filter must always be used.
- The 3M™ High Air Flow filter should be cleaned periodically. Both filters can be vacuumed.

**IMPORTANT: NEVER operate the unit without a filter.**

## End of Season Storage:

- Unplug the unit.
- Drain the condensed water COMPLETELY.
- Clean the upper and lower filter.



# Troubleshooting

Never try to repair or dismantle the air conditioner yourself. Tampering with the unit may result in the loss of warranty and can endanger the user and property.

Problem	Cause	Solution
<b>The Air Conditioner Does Not Function Properly</b>	Windows or doors are open.	Close doors and windows.
	The filter is dirty.	Clean or replace filter.
	Air inlet or air outlet is blocked.	Remove blockage.
	Room temperature lower than the selected value.	Lower temperature selected.
<b>The Unit Does Nothing</b>	The overheat protection is activated.	Wait 3 minutes until temperature has decreased, then turn on again.
	No power supply.	Make sure outlet works. Be sure Green Light is on (L.C.D.I. Plug) Press Re-start button.
	Water container is full. The LCD light is flashing	Drain the Unit.
	Timer Function Set.	Deactivate the Timer Function.
<b>The Unit is Noisy</b>	Unit is not standing on a level surface.	Place on an even surface.
<b>The Remote Control Does Not Function</b>	Distance too great.	Make sure the remote is aimed at the control panel.
	Remote control signal not detected by control panel.	Control is aimed at the control panel.
	Batteries are dead.	Replace the batteries.

If you have any questions regarding the operation of the this product please contact **AMCOR** at **1-866-361-2233**

## REPLACEMENT FILTERS:

To purchase Replacement Filters for this unit, contact **AMCOR** at **1-866-361-2233** and request model number **PVMB-12000E**

If this product is defective or not working properly, please **DO NOT** return to your retail store.

Please contact **Ancor** for service or technical assistance

**Ancor Inc.**

**[www.amcorgroupusa.com](http://www.amcorgroupusa.com)**



**Don't forget to register your Amcor purchase online,  
and view our broad selection of innovative products.**

**[www.amcorgroupusa.com](http://www.amcorgroupusa.com)**





## One Year Limited Warranty (5 Years for Compressor Only)

Amcors, Inc. ("Amcor") warrants the original retail purchaser ("Purchaser") purchasing in the United States that the Amcor product with which this warranty is enclosed is free from defects in materials and workmanship.

Amcors's sole obligation under this warranty is to replace, or at Amcor's discretion, to repair, free of charge, all defective parts, for a period of one (1) year from date of original purchase. (5 years for Compressor Only) ANY IMPLIED WARRANTY OF MERCHANTABILITY IS SIMILARLY LIMITED TO ONE (1) YEAR -(5 years for Compressor Only) FROM DATE OF ORIGINAL PURCHASE AND NO ACTION BASED UPON ANY IMPLIED WARRANTY OF MERCHANTABILITY OR OTHERWISE MAY BE COMMENCED AFTER EXPIRATION OF ONE (1) YEAR -(5 years for Compressor Only) FROM DATE OF ORIGINAL RETAIL PURCHASE. Some states do not allow limitations on how long an implied warranty lasts, so the above limitation -(5 years for Compressor Only) may not apply to you.

The provisions of this warranty shall not apply to any product which in Amcor's judgment has been (1) subject to misuse or neglect. (2) damaged in an accident. (3) used for a purpose for which it was not designed, or (4) repaired or altered in any way that adversely affected its performance or reliability.

To obtain warranty service, the defective product or part must be shipped or delivered to: Amcor's authorized service center. All postage, insurance and shipping charges are the responsibility of the Purchaser and are not included in this warranty.

AMCOR NEITHER ASSUMES NOR AUTHORIZES ANY PERSON TO ASSUME FOR IT ANY OTHER ( LIABILITY IN CONNECTION WITH ITS PRODUCTS, THERE ARE NO WARRANTIES WHICH EXTEND BEYOND THE DESCRIPTION ON THE FACE HEREOF. NO RESPONSIBILITY IS ASSUMED FOR INCIDENTAL OR CONSEQUENTIAL DAMAGES THAT MAY RESULT FROM THE USE OF AN AMCOR PRODUCT, NOR FOR THE DAMAGES DUE TO ACCIDENT, ABUSE, LACK OF RESPONSIBLE CARE, THE AFFIXING OF ANY UNAUTHORIZED ATTACHMENT, LOSS OF PARTS, OR USE AT A VOLTAGE OTHER THAN SPECIFIED. Some states do not allow the exclusion of limitation of incidental or consequential damages, so these limitations may not apply to you.

Amcors disclaims all liabilities for defects or damages caused by use of replacement parts obtained from or by service at any service center other than Amcor's authorized service center.

This warranty gives you specific legal rights, and you may also have other rights which vary from state to state.

Product: **AMCOR Plasma I20000 Portable Air Conditioner** Model: PVMB-I2000E

Date Purchased: \_\_\_\_\_ Production Code: \_\_\_\_\_

QUESTIONS? Call 1-866-361-2233 [www.amcorgroupusa.com](http://www.amcorgroupusa.com)

Dear Customer: Please keep this warranty for your record. **DO NOT** return it.

## Free Manuals Download Website

<http://myh66.com>

<http://usermanuals.us>

<http://www.somanuals.com>

<http://www.4manuals.cc>

<http://www.manual-lib.com>

<http://www.404manual.com>

<http://www.luxmanual.com>

<http://aubethermostatmanual.com>

Golf course search by state

<http://golfingnear.com>

Email search by domain

<http://emailbydomain.com>

Auto manuals search

<http://auto.somanuals.com>

TV manuals search

<http://tv.somanuals.com>