

M3A78-T

The ASUS logo is located in the top right corner of the page. It consists of the word "ASUS" in a bold, black, sans-serif font, with a registered trademark symbol (®) to the upper right of the letter "S".

Motherboard

E4018

Second Edition

July 2008

Copyright © 2008 ASUSTeK COMPUTER INC. All Rights Reserved.

No part of this manual, including the products and software described in it, may be reproduced, transmitted, transcribed, stored in a retrieval system, or translated into any language in any form or by any means, except documentation kept by the purchaser for backup purposes, without the express written permission of ASUSTeK COMPUTER INC. ("ASUS").

Product warranty or service will not be extended if: (1) the product is repaired, modified or altered, unless such repair, modification or alteration is authorized in writing by ASUS; or (2) the serial number of the product is defaced or missing.

ASUS PROVIDES THIS MANUAL "AS IS" WITHOUT WARRANTY OF ANY KIND, EITHER EXPRESS OR IMPLIED, INCLUDING BUT NOT LIMITED TO THE IMPLIED WARRANTIES OR CONDITIONS OF MERCHANTABILITY OR FITNESS FOR A PARTICULAR PURPOSE. IN NO EVENT SHALL ASUS, ITS DIRECTORS, OFFICERS, EMPLOYEES OR AGENTS BE LIABLE FOR ANY INDIRECT, SPECIAL, INCIDENTAL, OR CONSEQUENTIAL DAMAGES (INCLUDING DAMAGES FOR LOSS OF PROFITS, LOSS OF BUSINESS, LOSS OF USE OR DATA, INTERRUPTION OF BUSINESS AND THE LIKE), EVEN IF ASUS HAS BEEN ADVISED OF THE POSSIBILITY OF SUCH DAMAGES ARISING FROM ANY DEFECT OR ERROR IN THIS MANUAL OR PRODUCT.

SPECIFICATIONS AND INFORMATION CONTAINED IN THIS MANUAL ARE FURNISHED FOR INFORMATIONAL USE ONLY, AND ARE SUBJECT TO CHANGE AT ANY TIME WITHOUT NOTICE, AND SHOULD NOT BE CONSTRUED AS A COMMITMENT BY ASUS. ASUS ASSUMES NO RESPONSIBILITY OR LIABILITY FOR ANY ERRORS OR INACCURACIES THAT MAY APPEAR IN THIS MANUAL, INCLUDING THE PRODUCTS AND SOFTWARE DESCRIBED IN IT.

Products and corporate names appearing in this manual may or may not be registered trademarks or copyrights of their respective companies, and are used only for identification or explanation and to the owners' benefit, without intent to infringe.

Contents

Contents	iii
Notices	vii
Safety information	viii
About this guide	ix
M3A78-T specifications summary	xi

Chapter 1: Product introduction

1.1	Welcome!	1-1
1.2	Package contents	1-1
1.3	Special features	1-2
1.3.1	Product highlights	1-2
1.3.2	ASUS unique features	1-4
1.3.3	ASUS intelligent performance and overclocking features	1-6

Chapter 2: Hardware information

2.1	Before you proceed	2-1
2.2	Motherboard overview	2-2
2.2.1	Placement direction	2-2
2.2.2	Screw holes	2-2
2.2.3	Motherboard layout	2-3
2.2.4	Layout contents	2-4
2.3	Central Processing Unit (CPU)	2-6
2.3.1	Installing the CPU	2-6
2.3.2	Installing the heatsink and fan	2-8
2.4	System memory	2-11
2.4.1	Overview	2-11
2.4.2	Memory configurations	2-12
2.4.3	Installing a DIMM	2-13
2.4.4	Removing a DIMM	2-13
2.5	Expansion slots	2-14
2.5.1	Installing an expansion card	2-14
2.5.2	Configuring an expansion card	2-14
2.5.3	Interrupt assignments	2-15
2.5.4	PCI slots	2-16
2.5.5	PCI Express x1 slot	2-16

Contents

2.5.6	PCI Express 2.0 x16 slot (blue)	2-16
2.5.7	Universal PCI Express x16 slots (black and white).....	2-16
2.6	Jumper	2-18
2.7	Connectors	2-19
2.7.1	Rear panel connectors.....	2-19
2.7.2	Internal connectors	2-23
 Chapter 3: Powering up		
3.1	Starting up for the first time.....	3-1
3.2	Turning off the computer.....	3-2
3.2.1	Using the OS shut down function.....	3-2
3.2.2	Using the dual function power switch.....	3-2
 Chapter 4: BIOS setup		
4.1	Managing and updating your BIOS	4-1
4.1.1	Creating a bootable floppy disk.....	4-2
4.1.2	ASUS EZ Flash 2 utility.....	4-3
4.1.3	AFUDOS utility.....	4-4
4.1.4	ASUS Update utility	4-6
4.2	BIOS setup program	4-9
4.2.1	BIOS menu screen.....	4-10
4.2.2	Menu bar.....	4-10
4.2.3	Navigation keys.....	4-10
4.2.4	Menu items	4-11
4.2.5	Sub-menu items.....	4-11
4.2.6	Configuration fields	4-11
4.2.7	Pop-up window	4-11
4.2.8	Scroll bar.....	4-11
4.2.9	General help	4-11
4.3	Main menu	4-12
4.3.1	System Time [xx:xx:xx]	4-12
4.3.2	System Date [Day xx/xx/xxxx].....	4-12
4.3.3	Legacy Diskette A [1.44M, 3.5 in.].....	4-12
4.3.4	Primary IDE Master/Slave.....	4-13
4.3.5	SATA1/2/3/4/5/6	4-14
4.3.6	Storage Configuration	4-15

4.3.7	System Information	4-16
4.4	Advanced menu	4-17
4.4.1	Jumperfree Configuration	4-17
4.4.2	AI NET 2.....	4-21
4.4.3	CPU Configuration	4-22
4.4.4	Chipset.....	4-23
4.4.5	ECC Configuration	4-26
4.4.6	Onboard Devices Configuration.....	4-28
4.4.7	PCI PnP	4-29
4.4.8	USB Configuration	4-30
4.5	Power menu.....	4-31
4.5.1	Suspend Mode [Auto]	4-31
4.5.2	Repost Video on S3 Resume [No]	4-31
4.5.3	ACPI 2.0 Support [Disabled]	4-31
4.5.4	ACPI APIC Support [Enabled].....	4-31
4.5.5	APM Configuration.....	4-32
4.5.6	Hardware Monitor	4-34
4.6	Boot menu	4-35
4.6.1	Boot Device Priority	4-35
4.6.2	Boot Settings Configuration	4-36
4.6.3	Security	4-37
4.7	Tools menu	4-39
4.7.1	ASUS EZ Flash 2.....	4-39
4.7.2	Express Gate	4-40
4.7.3	ASUS O.C. Profile.....	4-41
4.8	Exit menu	4-42

Chapter 5: Software support

5.1	Installing an operating system	5-1
5.2	Support DVD information	5-1
5.2.1	Running the support DVD	5-1
5.2.2	Drivers menu.....	5-2
5.2.3	Utilities menu	5-3
5.2.4	Make Disk menu	5-5
5.2.5	Manual menu	5-6
5.2.6	ASUS Contact information	5-6

5.2.7	Other information	5-7
5.3	Software information	5-9
5.3.1	ASUS MyLogo2™	5-9
5.3.2	Cool 'n' Quiet!™ Technology.....	5-11
5.3.3	Audio configurations	5-14
5.3.4	ASUS PC Probe II.....	5-22
5.3.5	ASUS AI Suite.....	5-28
5.3.6	ASUS AI Gear 2.....	5-30
5.3.7	ASUS AI Nap	5-31
5.3.8	ASUS Q-Fan 2.....	5-32
5.3.9	ASUS AI Booster.....	5-33
5.3.10	ASUS Express Gate	5-34
5.3.11	AMD OverDrive (AOD)	5-43
5.4	RAID configurations	5-44
5.4.1	RAID definitions	5-44
5.4.2	Installing Serial ATA hard disks	5-45
5.4.3	AMD® RAID configurations.....	5-45
5.5	Creating a RAID driver disk.....	5-51
5.5.1	Creating a RAID driver disk without entering the OS....	5-51
5.5.2	Creating a RAID/SATA driver disk in Windows®	5-51
 Chapter 6: ATI® Hybrid CrossFireX™ technology support		
6.1	ATI® Hybrid CrossFireX™	6-1
6.1.1	System requirements	6-1
6.1.2	Before you proceed.....	6-1
6.1.3	Installing AMD Chipset Driver	6-2
6.1.4	Using the ATI CATALYST® Control Center	6-2

Notices

Federal Communications Commission Statement

This device complies with Part 15 of the FCC Rules. Operation is subject to the following two conditions:

- This device may not cause harmful interference, and
- This device must accept any interference received including interference that may cause undesired operation.

This equipment has been tested and found to comply with the limits for a Class B digital device, pursuant to Part 15 of the FCC Rules. These limits are designed to provide reasonable protection against harmful interference in a residential installation. This equipment generates, uses and can radiate radio frequency energy and, if not installed and used in accordance with manufacturer's instructions, may cause harmful interference to radio communications. However, there is no guarantee that interference will not occur in a particular installation. If this equipment does cause harmful interference to radio or television reception, which can be determined by turning the equipment off and on, the user is encouraged to try to correct the interference by one or more of the following measures:

- Reorient or relocate the receiving antenna.
- Increase the separation between the equipment and receiver.
- Connect the equipment to an outlet on a circuit different from that to which the receiver is connected.
- Consult the dealer or an experienced radio/TV technician for help.



The use of shielded cables for connection of the monitor to the graphics card is required to assure compliance with FCC regulations. Changes or modifications to this unit not expressly approved by the party responsible for compliance could void the user's authority to operate this equipment.

Canadian Department of Communications Statement

This digital apparatus does not exceed the Class B limits for radio noise emissions from digital apparatus set out in the Radio Interference Regulations of the Canadian Department of Communications.

This class B digital apparatus complies with Canadian ICES-003.

Safety information

Electrical safety

- To prevent electrical shock hazard, disconnect the power cable from the electrical outlet before relocating the system.
- When adding or removing devices to or from the system, ensure that the power cables for the devices are unplugged before the signal cables are connected. If possible, disconnect all power cables from the existing system before you add a device.
- Before connecting or removing signal cables from the motherboard, ensure that all power cables are unplugged.
- Seek professional assistance before using an adapter or extension cord. These devices could interrupt the grounding circuit.
- Make sure that your power supply is set to the correct voltage in your area. If you are not sure about the voltage of the electrical outlet you are using, contact your local power company.
- If the power supply is broken, do not try to fix it by yourself. Contact a qualified service technician or your retailer.

Operation safety

- Before installing the motherboard and adding devices on it, carefully read all the manuals that came with the package.
- Before using the product, make sure all cables are correctly connected and the power cables are not damaged. If you detect any damage, contact your dealer immediately.
- To avoid short circuits, keep paper clips, screws, and staples away from connectors, slots, sockets and circuitry.
- Avoid dust, humidity, and temperature extremes. Do not place the product in any area where it may become wet.
- Place the product on a stable surface.
- If you encounter technical problems with the product, contact a qualified service technician or your retailer.



This symbol of the crossed out wheeled bin indicates that the product (electrical, electronic equipment, and mercury-containing button cell battery) should not be placed in municipal waste. Check local regulations for disposal of electronic products.

About this guide

This user guide contains the information you need when installing and configuring the motherboard.

How this guide is organized

This guide contains the following parts:

- **Chapter 1: Product introduction**
This chapter describes the features of the motherboard and the new technology it supports.
- **Chapter 2: Hardware information**
This chapter lists the hardware setup procedures that you have to perform when installing system components. It includes description of the switches, jumpers, and connectors on the motherboard.
- **Chapter 3: Powering up**
This chapter describes the power up sequence and ways of shutting down the system.
- **Chapter 4: BIOS setup**
This chapter tells how to change system settings through the BIOS Setup menu. Detailed descriptions of the BIOS parameters are also provided.
- **Chapter 5: Software support**
This chapter describes the contents of the support DVD that comes with the motherboard package and the software.
- **Chapter 6: ATI® Hybrid CrossFireX™ support**
This chapter describes the ATI® Hybrid CrossFireX™ feature and shows the graphics card installation procedures.

Where to find more information

Refer to the following sources for additional information and for product and software updates.

1. **ASUS websites**
The ASUS website provides updated information on ASUS hardware and software products. Refer to the ASUS contact information.
2. **Optional documentation**
Your product package may include optional documentation, such as warranty flyers, that may have been added by your dealer. These documents are not part of the standard package.

Conventions used in this guide

To make sure that you perform certain tasks properly, take note of the following symbols used throughout this manual.



DANGER/WARNING: Information to prevent injury to yourself when trying to complete a task.



CAUTION: Information to prevent damage to the components when trying to complete a task.



IMPORTANT: Instructions that you **MUST** follow to complete a task.



NOTE: Tips and additional information to help you complete a task.

Typography

Bold text

Indicates a menu or an item to select.

Italics

Used to emphasize a word or a phrase.

<Key>

Keys enclosed in the less-than and greater-than sign means that you must press the enclosed key.

Example: <Enter> means that you must press the Enter or Return key.

<Key1+Key2+Key3>

If you must press two or more keys simultaneously, the key names are linked with a plus sign (+).

Example: <Ctrl+Alt+D>

Command

Means that you must type the command exactly as shown, then supply the required item or value enclosed in brackets.

Example: At the DOS prompt, type the command line:

afudos M3A78T.rom

M3A78-T specifications summary

CPU	AMD® Socket AM2/AM2+ for AMD® Phenom™ FX / Phenom™ / Athlon™ / Sempron™ processors AMD Cool 'n' Quiet™ Technology Supports CPU TDP up to 140W
Chipset	AMD® 790GX + SB750
System bus	Up to 5200 MT/s; HyperTransport™ 3.0 interface for AM2+ CPU 2000 / 1600 MT/s for AM2 CPU
Memory	Dual-channel memory architecture - 4 x 240-pin DIMM sockets support unbuffered ECC/ non-ECC DDR2 1066*/800/667 MHz memory modules - Supports up to 8 GB system memory *DDR2 1066 is supported by AM2+ CPU for one DIMM per channel only. ** When installing total memory of 4GB capacity or more, Windows 32-bit operation system may only recognize less than 3GB. Hence, a total installed memory of less than 3GB is recommended.
VGA	Integrated ATI Radeon™ HD 3300 GPU, SidePort Memory – onboard 128MB DDR3 1333 memory - Supports HDMI™ Technology (HDCP compliant) with max. resolution up to 1920 x 1200 (1080P) - Supports DVI with max. resolution up to 2560 x 1600 @ 60Hz - Supports D-Sub with max. resolution up to 2560 x 1440 @ 75 Hz - Hybrid CrossFireX™ support (For Windows Vista only) - HDMI/DVI/RGB output support - Supports Microsoft® DirectX 10, OpenGL 2.0, Pixel Shader 4.0 - Maximum shared memory of 512MB
Expansion slots	3 x PCIe 2.0 x16 slots* - Supports PCIe 2.0/1.0 architecture 1 x PCIe x1 slots 2 x PCI 2.2 slots
Storage	SB750 chipset 1 x Ultra DMA 133/100/66/33 interface 5 x SATA 3Gb/s ports supporting RAID 0, 1, 5 and 10 configuration 1 x eSATA 3Gb/s port supporting RAID 0, 1, 5 and 10 configuration
LAN	Marvell® 88E8056 Gigabit LAN

(continued on the next page)

M3A78-T specifications summary

High Definition audio	Realtek® ALC1200 8-channel High Definition audio CODEC - Optical S/PDIF Out port at back I/O
IEEE 1394	LSI® FW322 controller supports 2 x IEEE 1394a ports (1 at mid-board; 1 on the rear panel)
USB	12 x USB 2.0 ports (6 at mid-board; 6 on the rear panel)
ASUS unique features	<p>ASUS Express Gate:</p> <ul style="list-style-type: none"> - Web browser, file downloading and uploading* - Further free features upgradable <p>*File downloading and uploading through USB devices only.</p> <p>ASUS Quiet Thermal Solution:</p> <ul style="list-style-type: none"> - ASUS 4+1 Phase Power Design - ASUS AI Gear 2 - ASUS AI Nap - ASUS Q-Fan 2 <p>ASUS Crystal Sound:</p> <ul style="list-style-type: none"> - ASUS Noise Filter <p>ASUS EZ DIY:</p> <ul style="list-style-type: none"> - ASUS Q-Shield - ASUS Q-Connector - ASUS O.C. Profile - ASUS EZ Flash 2
Other features	Uses 100% All High-quality Conductive Polymer Capacitors! ASUS MyLogo 2™
ASUS exclusive overclocking features	<p>Intelligent overclocking tools:</p> <ul style="list-style-type: none"> - AI Overclocking (intelligent CPU frequency tuner) - ASUS AI Booster utility <p>Precision Tweaker 2:</p> <ul style="list-style-type: none"> - vCore: Adjustable CPU voltage at 0.0125V increment - vDIMM: 35-step DRAM voltage control - vChipset: 25-step voltage control <p>SFS (Stepless Frequency Selection):</p> <ul style="list-style-type: none"> - FSB tuning from 200MHz up to 600MHz at 1MHz increment - Memory tuning from 533MHz up to 1066MHz - PCIe frequency tuning from 100MHz to 200MHz at 1MHz increment <p>Overclocking protection:</p> <ul style="list-style-type: none"> - ASUS C.P.R. (CPU Parameter Recall)

(continued on the next page)

M3A78-T specifications summary

Rear panel I/O ports	1 x PS/2 Keyboard / Mouse combo port 1 x S/PDIF Out (Optical) 1 x HDMI Out 1 x DVI Out 1 x D-Sub 1 x External SATA 1 x IEEE 1394a port 1 x LAN (RJ-45) 6 x USB 2.0/1.1 8-channel audio I/O
Internal I/O connectors	3 x USB connectors support additional 6 USB ports 1 x Floppy disk drive connector 1 x IDE connector 5 x SATA connectors 1 x CPU Fan connector 2 x Chassis Fan connectors 1 x Power Fan connector 1 x IEEE1394a connector 1 x Front panel audio connector 1 x S/PDIF Out Header 1 x Chassis Intrusion connector 1 x CD audio in 1 x 24-pin ATX Power connector 1 x 4-pin ATX 12V Power connector 1 x System Panel (Q-Connector)
BIOS features	8 Mb Flash ROM, AMI BIOS, PnP, DMI 2.0, WfM2.0, SM BIOS 2.5, ACPI 2.0a, ASUS EZ Flash 2
Support DVD contents	Drivers Express Gate ASUS PC Probe II ASUS Update AMD AOD Anti-virus Utility (OEM version)
Form factor	ATX form factor: 12 in x 9.6 in (30.5 cm x 24.4 cm)

*Specifications are subject to change without notice.

This chapter describes the motherboard features and the new technologies it supports.

1 Product introduction

Chapter summary

1

1.1	Welcome!	1-1
1.2	Package contents.....	1-1
1.3	Special features.....	1-2

1.1 Welcome!

Thank you for buying an ASUS® M3A78-T motherboard!

The motherboard delivers a host of new features and latest technologies, making it another standout in the long line of ASUS quality motherboards!

Before you start installing the motherboard, and hardware devices on it, check the items in your package with the list below.

1.2 Package contents

Check your motherboard package for the following items.

Motherboard	ASUS M3A78-T
Cables	Serial ATA power cables Serial ATA signal cables Ultra DMA 133/100/66 cable Floppy disk drive cable
Accessories	1 x ASUS Q-Shield 1 x ASUS Q-Connector Kit (USB, 1394, system panel; Retail version only)
Application DVD	ASUS motherboard support DVD
Documentation	User guide



If any of the above items is damaged or missing, contact your retailer.

1.3 Special features

1.3.1 Product highlights

Green ASUS



This motherboard and its packaging comply with the European Union's Restriction on the use of Hazardous Substances (RoHS). This is in line with the ASUS vision of creating environment-friendly and recyclable products/packaging to safeguard consumers' health while minimizing the impact on the environment.

AMD® Socket AM2+ Phenom™ FX / Phenom / Athlon™ / Sempron™ CPU support



This motherboard supports AMD® Socket AM2+ multi-core processors with unique L3 cache and delivers better overclocking capabilities with less power consumption. It features dual-channel DDR2 1066 memory support and accelerates data transfer rate up to 5200MT/s via HyperTransport™ 3.0 based system bus.

HyperTransport™ 3.0 support



HyperTransport™ 3.0 technology provides 2.6 times more bandwidth than HyperTransport™ 1.0, radically improving system efficiency to create a smoother, faster computing environment.

AMD® Socket AM2 Athlon™ Series / Sempron™ CPU support



This motherboard supports AMD® Socket AM2 Athlon™ Series / Sempron™ processors. It features 2000/1600 MT/s HyperTransport™-based system bus, dual-channel un-buffered DDR2 800 memory support, and AMD® Cool 'n' Quiet™ Technology.

AMD® 790GX + SB750 Chipset

AMD® 790GX + SB750 Chipset is designed to support up to 5200MT/s HyperTransport™ 3.0 (HT 3.0) interface speed and PCI Express™ 2.0 x16 graphics. It is optimized with AMD®'s latest AM2+ and multi-core CPUs to provide excellent system performance and overclocking capabilities.

Native DDR2 1066 support



This motherboard is the first AMD® platform with native DDR2 1066 support. It provides faster data transfer rate and more bandwidth to increase memory computing efficiency, enhancing system performance in 3D graphics and other memory demanding applications.



DDR2 1066 is supported by AM2+ CPUs only.

AMD® Hybrid CrossFireX Technology



Hybrid CrossFireX Technology is a unique multi-GPU technology combining the onboard GPU and the discrete graphics card together to enhance 3D graphics performance.



Visit www.amd.com for the Hybrid CrossfireX selected GPUs.

HDMI/DVI/D-Sub Interface



HDMI (High-Definition Multimedia Interface) is a set of digital video standards that delivers multi-channel audio and uncompressed digital video through a single cable for full HD 1080p visuals. Supporting HDCP copy protection such as HD DVD and Blu-ray Discs, HDMI provides you with the highest-quality home theater experience.

DVI (Digital Visual Interface) provides high quality visuals for digital display devices like LCD monitors.

SidePort Memory



This motherboard features SidePort Memory, an individual onboard DDR3 memory serving as memory buffer for integrated graphics. With low CPU usage, the SidePort Memory provides integrated graphics acceleration and effectively boosts graphics performance.

PCIe 2.0 support



This motherboard supports the latest PCIe 2.0 devices for double speed and bandwidth which enhances system performance.

Serial ATA 3.0 Gb/s technology



This motherboard supports the next-generation hard disk drives based on the Serial ATA (SATA) 3Gb/s storage specifications, delivering enhanced scalability and doubling the bus bandwidth for high-speed data retrieval and save. It allows RAID 0, 1, 0+1 and 5 configurations.

IEEE 1394a support



The IEEE 1394a interface provides high speed digital interface for audio/video appliances such as digital television, digital video camcorders, storage peripherals, and other PC portable devices.

S/PDIF digital sound ready

This motherboard provides convenient connectivity to external home theater audio systems via the coaxial S/PDIF (SONY-PHILIPS Digital Interface) Out jack. It allows digital audio transferring without converting it to analog format, and therefore well preserves signal quality.

High Definition Audio

Enjoy high-end sound quality on your PC! The onboard 8-channel HD audio (High Definition Audio, previously codenamed Azalia) CODEC enables high-quality 192KHz/24-bit audio output that simultaneously sends different audio streams to different destinations. You can now talk to your partners on the headphones while playing multi-channel network games.

1.3.2 ASUS unique features

ASUS Express Gate

Just 5 seconds to boot up, ASUS Express Gate allows you to instantly surf the Internet without entering Windows. You can now enjoy Skype, IM, YouTube, webmail and Internet file downloads and sharing whenever and wherever you want!



- The bootup speed depends on system configurations.
- Due to chipset limitation, **ASUS Express Gate supports USB devices or SATA HDDs (IDE mode) connected to SATA port 1-4 only.** Set the **SATA Operation Mode** item in the BIOS to [IDE] before installing and using ASUS Express Gate.
- Currently, ASUS Express Gate DOES NOT support PATA IDE HDDs. Visit www.asus.com for future BIOS and Express Gate software updates.

ASUS Quiet Thermal Solution

ASUS Quiet Thermal solution makes system more stable and enhances the overclocking capability.

AI Gear 2

AI Gear 2 allows you to choose from profiles to adjust CPU frequency and vCore voltage, minimizing system noise and saving CPU power consumption at most. You can real-time change the mode under operating system to suit your needs.

AI Nap

With AI Nap, the system can continue running at minimum power and noise when you are temporarily away. To wake the system and return to the OS environment, simply click the mouse or press a key.

Q-Fan 2

ASUS Q-Fan 2 technology intelligently adjusts both CPU fan and chassis fan speeds according to system loading to ensure quiet, cool and efficient operation. See page 2-34 for details.

ASUS Crystal Sound

This feature can enhance speech-centric applications like Skype, online game, video conference and recording.

Noise Filter

This feature detects repetitive and stationary noises (non-voice signals) like computer fans, air conditioners, and other background noises then eliminates it in the incoming audio stream while recording.

ASUS EZ DIY

ASUS EZ DIY feature collection provides you easy ways to install computer components, update the BIOS or back up your favorite settings.

ASUS Q-Shield

The specially designed ASUS Q-Shield does without the usual “fingers”—making it convenient and easy to install. With better electric conductivity, it ideally protects your motherboard against static electricity and shields it against Electronic Magnetic Interference (EMI).

ASUS Q-Connector

ASUS Q-Connector allows you to easily connect or disconnect the chassis front panel cables to the motherboard. This unique module eliminates the trouble of connecting the system panel cables one at a time and avoiding wrong cable connections.

ASUS EZ Flash 2



ASUS EZ Flash 2 is a user-friendly BIOS update utility. Simply press the predefined hotkey to launch the utility and update the BIOS without entering the OS. Update your BIOS easily without preparing a bootable diskette or using an OS-based flash utility.

ASUS MyLogo 2™



This feature allows you to convert your favorite photo into a 256-color boot logo for a more colorful and vivid image on your screen.

1.3.3 ASUS intelligent performance and overclocking features

Precision Tweaker 2



Allows the user to adjust the CPU voltage in 0.125v steps and NB/DRAM voltage in 0.02v steps to finetune voltages to achieve the most precise setting for the ultimate overclocking configuration.

AI Booster

The ASUS AI Booster allows you to overclock the CPU speed in Windows environment without the hassle of booting the BIOS.

C.P.R. (CPU Parameter Recall)



The C.P.R. feature of the motherboard BIOS allows automatic re-setting to the BIOS default settings in case the system hangs due to overclocking. When the system hangs due to overclocking, C.P.R. eliminates the need to open the system chassis and clear the RTC data. Simply shut down and reboot the system, and the BIOS automatically restores the CPU default setting for each parameter.

This chapter lists the hardware setup procedures that you have to perform when installing system components. It includes description of the jumpers and connectors on the motherboard.

Hardware information



2.1	Before you proceed	2-1
2.2	Motherboard overview.....	2-2
2.3	Central Processing Unit (CPU)	2-6
2.4	System memory	2-11
2.5	Expansion slots.....	2-14
2.6	Jumper	2-18
2.7	Connectors	2-19

2.1 Before you proceed

Take note of the following precautions before you install motherboard components or change any motherboard settings.



- Unplug the power cord from the wall socket before touching any component.
- Use a grounded wrist strap or touch a safely grounded object or to a metal object, such as the power supply case, before handling components to avoid damaging them due to static electricity.
- Hold components by the edges to avoid touching the ICs on them.
- Whenever you uninstall any component, place it on a grounded antistatic pad or in the bag that came with the component.
- Before you install or remove any component, ensure that the ATX power supply is switched off or the power cord is detached from the power supply. Failure to do so may cause severe damage to the motherboard, peripherals, and/or components.

Onboard LED

The motherboard comes with a standby power LED. The green LED lights up to indicate that the system is ON, in sleep mode, or in soft-off mode. This is a reminder that you should shut down the system and unplug the power cable before removing or plugging in any motherboard component. The illustration below shows the location of the onboard LED.

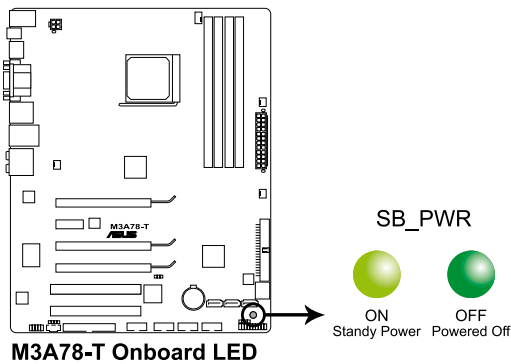

2.2 Motherboard overview

Before you install the motherboard, study the configuration of your chassis to ensure that the motherboard fits into it.



Make sure to unplug the power cord before installing or removing the motherboard. Failure to do so can cause you physical injury and damage motherboard components.

2.2.1 Placement direction

When installing the motherboard, make sure that you place it into the chassis in the correct orientation. The edge with external ports goes to the rear part of the chassis as indicated in the image below.

2.2.2 Screw holes

Place nine (9) screws into the holes indicated by circles to secure the motherboard to the chassis.



Do not overtighten the screws! Doing so can damage the motherboard.

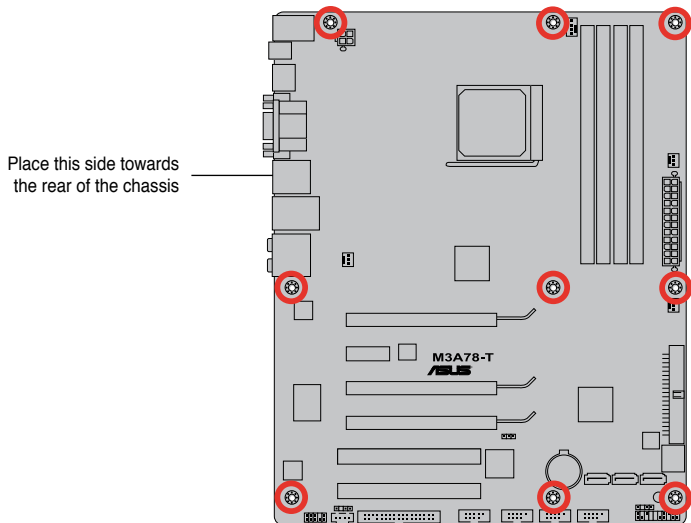

2.2.3 Motherboard layout

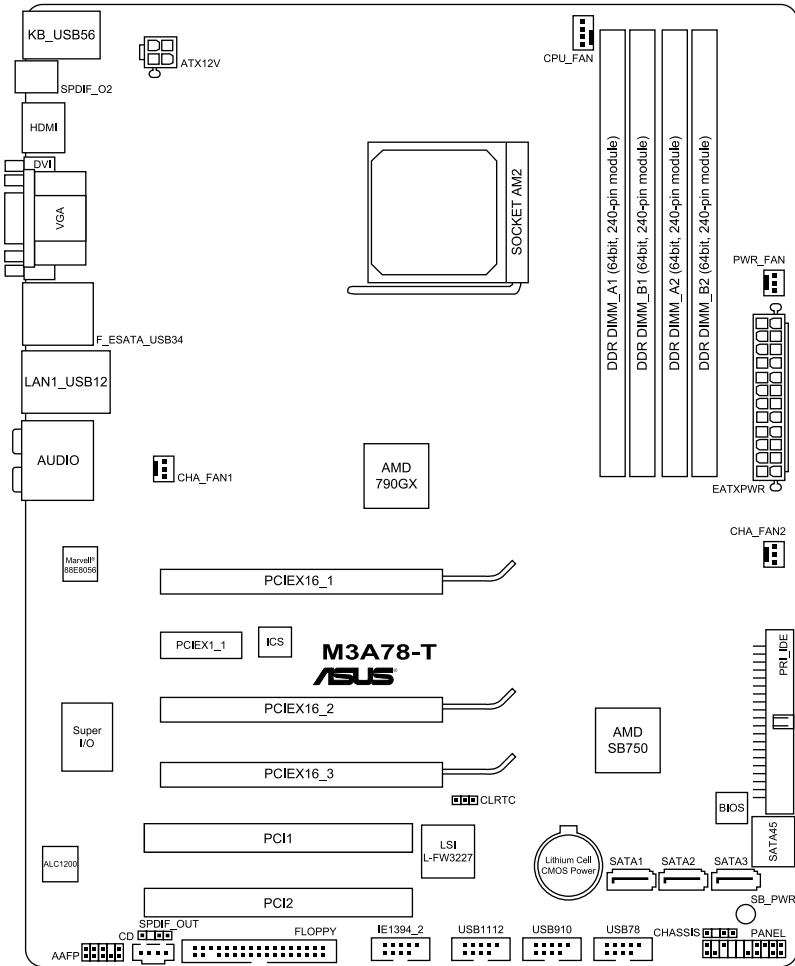

Refer to **2.7 Connectors** for more information about rear panel connectors and internal connectors.

2.2.4 Layout contents

Slots	Page
1. DDR2 DIMM slots	2-11
2. PCI slots	2-16
3. PCI Express x1 slot	2-16
4. PCI Express 2.0 x16 slot (blue)	2-16
5. Universal PCI Express x16 slots (black and white)	2-16

Jumper	Page
Clear RTC RAM (3-pin CLRTC)	2-18

Rear panel connectors	Page
1. PS/2 keyboard / mouse combo port	2-19
2. Video Graphics Adapter (VGA) port	2-19
3. USB 2.0 ports 1 and 2	2-19
4. LAN (RJ-45) port.	2-19
5. Center/Subwoofer port (orange)	2-19
6. Rear Speaker Out port (black)	2-19
7. Line In port (light blue)	2-19
8. Line Out port (lime)	2-19
9. Microphone port (pink)	2-19
10. Side Speaker Out port (gray)	2-19
11. USB 2.0 ports 3 and 4	2-20
12. External SATA port	2-20
13. IEEE 1394a port	2-20
14. DVI-D Out port	2-20
15. HDMI Out port	2-21
16. Optical S/PDIF Out port	2-21
17. USB 2.0 ports 5 and 6	2-21

Internal connectors		Page
1.	Floppy disk drive connector (34-1 pin FLOPPY)	2-23
2.	IDE connector (40-1 pin PRI_IDE)	2-24
3.	Serial ATA connectors (7-pin SATA1-5)	2-25
4.	USB connectors (10-1 pin USB78, USB910, USB1112)	2-26
5.	IEEE 1394a port connector (10-1 pin IE1394_2)	2-27
6.	CPU, chassis, and power fan connectors (4-pin CPU_FAN, 3-pin CHA_FAN1-2, 3-pin PWR_FAN)	2-28
7.	Chassis intrusion connector (4-1 pin CHASSIS)	2-29
8.	ATX power connectors (24-pin EATXPWR; 4-pin ATX12V)	2-30
9.	Front panel audio connector (10-1 pin AAFP)	2-31
10.	Optical drive audio connector (4-pin CD)	2-32
11.	Digital audio connector (4-1 pin SPDIF_OUT)	2-32
12.	System panel connector (20-8-pin PANEL)	2-33
13.	ASUS Q-Connector (system panel)	2-34

2.3 Central Processing Unit (CPU)

The motherboard comes with an AM2+/AM2 socket designed for AMD® Socket AM2+ Phenom™ FX / Phenom / Athlon™ / Sempron™ processors or for Socket AM2 Athlon series / Sempron processors.



The AM2+/AM2 socket has a different pinout from the 940-pin socket designed for the AMD Opteron processor. Make sure you use a CPU designed for the AM2+/AM2 socket. The CPU fits in only one correct orientation. DO NOT force the CPU into the socket to prevent bending the connectors on the socket and damaging the CPU!

2.3.1 Installing the CPU

To install a CPU:

1. Locate the CPU socket on the motherboard.

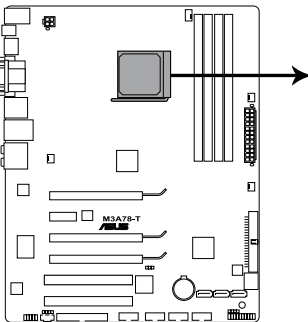

M3A78-T CPU socket AM2

2. Unlock the socket by pressing the lever sideways, then lift it up to a 90° angle.

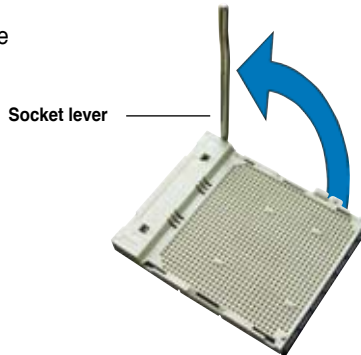

Make sure that the socket lever is lifted up to a 90° angle; otherwise, the CPU will not fit in completely.

3. Position the CPU above the socket such that the CPU corner with the gold triangle matches the socket corner with a small triangle.
4. Carefully insert the CPU into the socket until it fits in place.

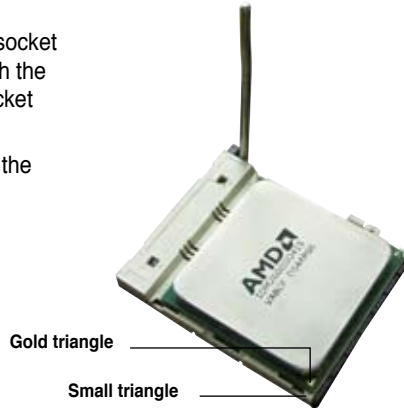

5. When the CPU is in place, push down the socket lever to secure the CPU. The lever clicks on the side tab to indicate that it is locked.
6. Install a CPU heatsink and fan following the instructions that came with the heatsink package.



2.3.2 Installing the heatsink and fan

The AMD® Phenom™ FX / Phenom / Athlon™ / Sempron™ processor requires a specially designed heatsink and fan assembly to ensure optimum thermal condition and performance.



Make sure that you use only AMD-certified heatsink and fan assembly.

To install the CPU heatsink and fan:

1. Place the heatsink on top of the installed CPU, making sure that the heatsink fits properly on the retention module base.



- The retention module base is already installed on the motherboard upon purchase.
 - You do not have to remove the retention module base when installing the CPU or installing other motherboard components.
 - If you purchased a separate CPU heatsink and fan assembly, make sure that a Thermal Interface Material is properly applied to the CPU heatsink or CPU before you install the heatsink and fan assembly.
-

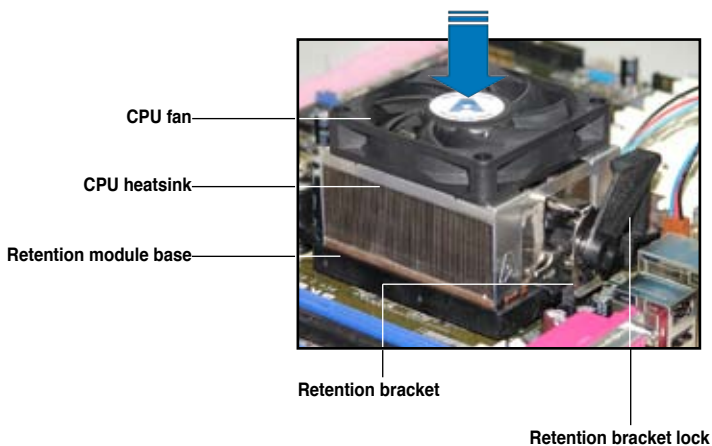

Your boxed CPU heatsink and fan assembly should come with installation instructions for the CPU, heatsink, and the retention mechanism. If the instructions in this section do not match the CPU documentation, follow the latter.

2. Attach one end of the retention bracket to the retention module base.

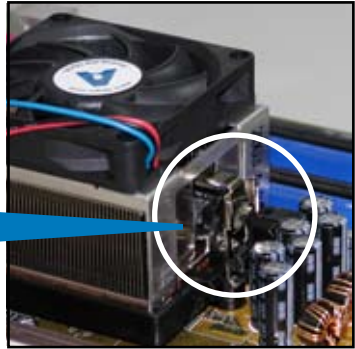

3. Align the other end of the retention bracket (near the retention bracket lock) to the retention module base. A clicking sound denotes that the retention bracket is in place.



Make sure that the fan and heatsink assembly perfectly fits the retention mechanism module base, otherwise you cannot snap the retention bracket in place.



4. Push down the retention bracket lock on the retention mechanism to secure the heatsink and fan to the module base.

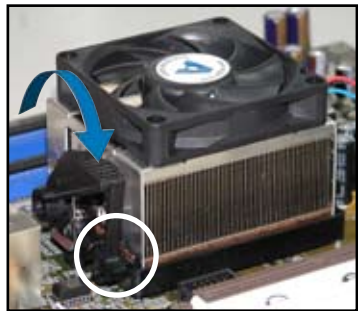

- When the fan and heatsink assembly is in place, connect the CPU fan cable to the connector on the motherboard labeled CPU_FAN.

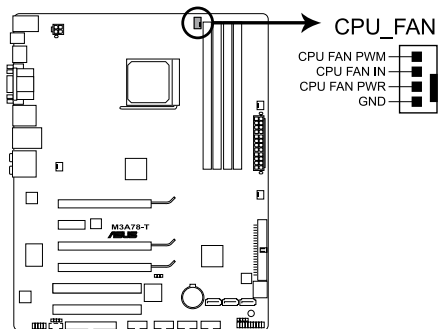

M3A78-T CPU fan connector



- Do not forget to connect the CPU fan connector! Hardware monitoring errors can occur if you fail to plug this connector.
- This connector is backward compatible with old 3-pin CPU fan.

2.4 System memory

2.4.1 Overview

The motherboard comes with four Double Data Rate 2 (DDR2) Dual Inline Memory Modules (DIMM) sockets.

The figure illustrates the location of the DDR2 DIMM sockets:

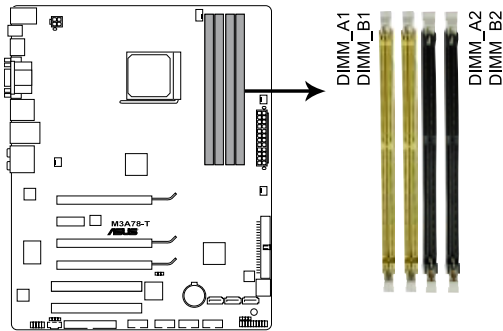

M3A78-T 240-pin DDR2 DIMM sockets

Channel	Sockets
Channel A	DIMM_A1 and DIMM_A2
Channel B	DIMM_B1 and DIMM_B2

2.4.2 Memory configurations

You may install 512 MB, 1 GB, and 2 GB unbuffered ECC and non-ECC DDR2 DIMMs into the DIMM sockets.

Recommended Memory Configurations

Mode	Sockets			
	DIMM_A1 (yellow)	DIMM_A2 (black)	DIMM_B1 (yellow)	DIMM_B2 (black)
Single-Channel	–	–	Populated	–
	Populated	–	–	–
Dual-channel (1)	Populated	–	Populated	–
Dual-channel (2)	Populated	Populated	Populated	Populated



- You may install varying memory sizes in Channel A and Channel B. The system maps the total size of the lower-sized channel for the dual-channel configuration. Any excess memory from the higher-sized channel is then mapped for single-channel operation.
- Always install DIMMs with the same CAS latency. For optimum compatibility, it is recommended that you obtain memory modules from the same vendor.
- When installing a total memory of 4GB capacity or more, Windows 32-bit operation system may only recognize less than 3GB. Hence, a total installed memory of less than 3GB is recommended.
- This motherboard does not support memory modules made up of 128 Mb chips.



Due to OS limitation, this motherboard can only support up to 8 GB on the operating systems listed below. You may install a maximum of 2 GB DIMMs on each slot.

64-bit

Windows® XP Professional x64 Edition
Windows® Vista x64 Edition

2.4.3 Installing a DIMM



Unplug the power supply before adding or removing DIMMs or other system components. Failure to do so can cause severe damage to both the motherboard and the components.

To install a DIMM:

1. Unlock a DIMM socket by pressing the retaining clips outward.
2. Align a DIMM on the socket such that the notch on the DIMM matches the break on the socket.
3. Firmly insert the DIMM into the socket until the retaining clips snap back in place and the DIMM is properly seated.

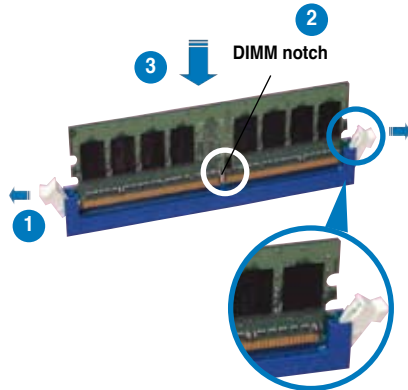

Unlocked retaining clip



- A DDR2 DIMM is keyed with a notch so that it fits in only one direction. Do not force a DIMM into a socket to avoid damaging the DIMM.
- The DDR2 DIMM sockets do not support DDR DIMMs. DO not install DDR DIMMs to the DDR2 DIMM sockets.

2.4.4 Removing a DIMM

To remove a DIMM:

1. Simultaneously press the retaining clips outward to unlock the DIMM.



Support the DIMM lightly with your fingers when pressing the retaining clips. The DIMM might get damaged when it flips out with extra force.

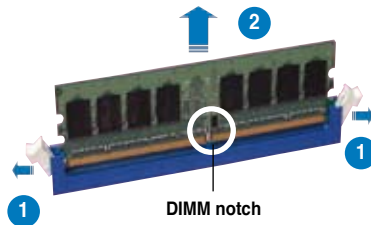

2. Remove the DIMM from the socket.

2.5 Expansion slots

In the future, you may need to install expansion cards. The following sub-sections describe the slots and the expansion cards that they support.



Make sure to unplug the power cord before adding or removing expansion cards. Failure to do so may cause you physical injury and damage motherboard components.

2.5.1 Installing an expansion card

To install an expansion card:

1. Before installing the expansion card, read the documentation that came with it and make the necessary hardware settings for the card.
2. Remove the system unit cover (if your motherboard is already installed in a chassis).
3. Remove the bracket opposite the slot that you intend to use. Keep the screw for later use.
4. Align the card connector with the slot and press firmly until the card is completely seated on the slot.
5. Secure the card to the chassis with the screw you removed earlier.
6. Replace the system cover.

2.5.2 Configuring an expansion card

After installing the expansion card, configure the it by adjusting the software settings.

1. Turn on the system and change the necessary BIOS settings, if any. See Chapter 4 for information on BIOS setup.
2. Assign an IRQ to the card. Refer to the tables on the next page.
3. Install the software drivers for the expansion card.



When using PCI cards on shared slots, ensure that the drivers support "Share IRQ" or that the cards do not need IRQ assignments; otherwise, conflicts will arise between the two PCI groups, making the system unstable and the card inoperable.

2.5.3 Interrupt assignments

Standard interrupt assignments

IRQ	Priority	Standard function
0	1	System Timer
1	2	Keyboard Controller
2	–	Redirect to IRQ#9
4	12	Communications Port (COM1)*
5	13	IRQ Holder for PCI Steering*
6	14	Floppy Disk Controller
7	15	Reserved
8	3	System CMOS/Real Time Clock
9	4	AMD ACPI-Compliant System
10	5	IRQ Holder for PCI Steering*
11	6	IRQ Holder for PCI Steering*
12	7	Reserved
13	8	Numeric Data Processor
14	9	Primary IDE Channel
15	10	Secondary IDE Channel

* These IRQs are usually available for ISA or PCI devices.

IRQ assignments for this motherboard

	A	B	C	D	E	F	G	H
PCIe x16_1	shared	shared	shared	shared	–	–	–	–
PCIe x16_2	shared	shared	shared	shared	–	–	–	–
PCIe x16_3	shared	shared	shared	shared	–	–	–	–
USB 1.0 controller 1	–	–	–	shared	–	–	–	–
USB 1.0 controller 2	–	–	–	shared	–	–	–	–
USB 1.0 controller 3	–	–	–	shared	–	–	–	–
USB 1.0 controller 4	–	–	–	shared	–	–	–	–
USB 2.0 controller	–	–	–	shared	–	–	–	–
HD audio	shared	–	–	–	–	–	–	–
Onboard SATA	–	–	–	–	–	shared	–	–

2.5.4 PCI slots

The PCI slots support cards such as a LAN card, SCSI card, USB card, and other cards that comply with PCI specifications. Refer to the figure below for the location of the slots.

2.5.5 PCI Express x1 slot

This motherboard supports PCI Express x1 network cards, SCSI cards and other cards that comply with the PCI Express specifications. Refer to the figure below for the location of the slot.

2.5.6 PCI Express 2.0 x16 slot (blue)

This motherboard supports PCI Express 2.0 x16 graphics cards that complies with the PCI Express specifications. Refer to the figure below for the location of the slot.

2.5.7 Universal PCI Express x16 slots (black and white)

This motherboard also supports two universal PCI Express 2.0 x16 slot at maximum x8 (white) and x4 (black) mode. The operating frequency of the slot change, depending on the type of PCI Express card you install. Refer to the figure below for the location of the slots.

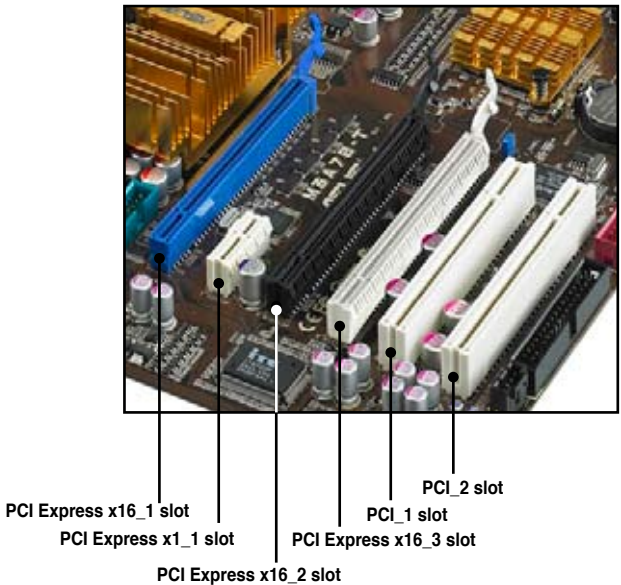

VGA configuration	PCI Express operating mode		
	PClex16_1	PClex16_2	PClex16_3
Single VGA/PCIe card	x16	x4	x8
Dual VGA/PCIe card	x16	x4	
		x4	x8
	x8		x8
Triple VGA/PCIe card	x8	x4	x8



-
- Currently, only Windows® Vista operation system supports Hybrid CrossFireX™ mode.
 - Currently, only AMD® HD3470, HD3450, HD2400XT and HD2400Pro graphics cards support the Hybrid CrossFireX™ function.
 - If you install two VGA cards, we recommend that you plug the rear chassis fan cable to the motherboard connector labeled CHA_FAN1 or CHA_FAN2 for better thermal environment. See page 2-28 for the connector location.
 - Visit the AMD official website at www.amd.com for more information about Hybrid CrossFireX™ support.
-

2.6 Jumper

Clear RTC RAM (3-pin CLRTC)

This jumper allows you to clear the Real Time Clock (RTC) RAM in CMOS. You can clear the CMOS memory of date, time, and system setup parameters by erasing the CMOS RTC RAM data. The onboard button cell battery powers the RAM data in CMOS, which include system setup information such as system passwords.

To erase the RTC RAM

1. Turn OFF the computer and unplug the power cord.
2. Move the jumper cap from pins 1-2 (default) to pins 2-3. Keep the cap on pins 2-3 for about 5~10 seconds, then move the cap back to pins 1-2.
3. Plug the power cord and turn ON the computer.
4. Hold down the key during the boot process and enter BIOS setup to re-enter data.



Except when clearing the RTC RAM, never remove the cap on CLRTC jumper default position. Removing the cap will cause system boot failure!



If the steps above do not help, remove the onboard battery and move the jumper again to clear the CMOS RTC RAM data. After the CMOS clearance, reinstall the battery.

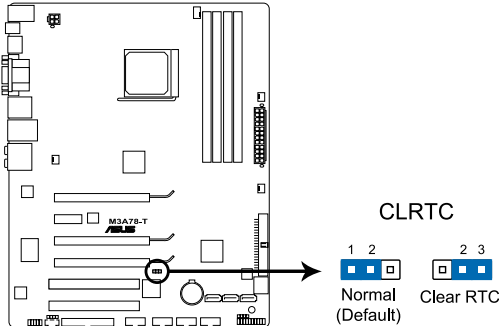

M3A78-T Clear RTC RAM



- You do not need to clear the RTC when the system hangs due to overclocking. For system failure due to overclocking, use the C.P.R. (CPU Parameter Recall) feature. Shut down and reboot the system so the BIOS can automatically reset parameter settings to default values.
- Due to the chipset limitation, AC power off is required prior using C.P.R. function. You must turn off and on the power supply or unplug and plug the power cord before reboot the system.

2.7 Connectors

2.7.1 Rear panel connectors

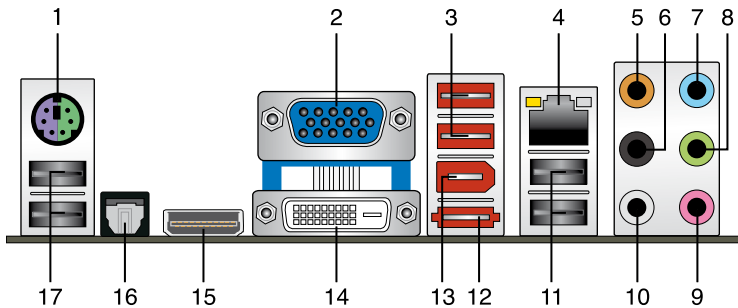

1. **PS/2 keyboard / mouse combo port.** This port is for a PS/2 keyboard or a PS/2 mouse.
2. **Video Graphics Adapter (VGA) port.** This 15-pin port is for a VGA monitor or other VGA-compatible devices.
3. **USB 2.0 ports 1 and 2.** These 4-pin Universal Serial Bus (USB) ports are available for connecting USB 2.0 devices.
4. **LAN (RJ-45) port.** Supported by Marvell® 88E1116 Gigabit LAN controller, this port allows Gigabit connection to a Local Area Network (LAN) through a network hub. Refer to the table below for the LAN port LED indications.

LAN port LED indications

Activity/Link LED		Speed LED	
Status	Description	Status	Description
OFF	No link	OFF	10 Mbps connection
ORANGE	Linked	ORANGE	100 Mbps connection
BLINKING	Data activity	GREEN	1 Gbps connection

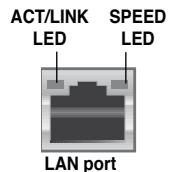

5. **Center/Subwoofer port (orange).** This port connects the center/subwoofer speakers.
6. **Rear Speaker Out port (black).** This port connects the rear speakers in a 4-channel, 6-channel, or 8-channel audio configuration.
7. **Line In port (light blue).** This port connects the tape, CD, DVD player, or other audio sources.
8. **Line Out port (lime).** This port connects a headphone or a speaker. In 4-channel, 6-channel, and 8-channel configuration, the function of this port becomes Front Speaker Out.
9. **Microphone port (pink).** This port connects a microphone.
10. **Side Speaker Out port (gray).** This port connects the side speakers in an 8-channel audio configuration.



Refer to the audio configuration table on the next page for the function of the audio ports in 2, 4, 6, or 8-channel configuration.

Audio 2, 4, 6, or 8-channel configuration

Port	Headset 2-channel	4-channel	6-channel	8-channel
Light Blue	Line In	Line In	Line In	Line In
Lime	Line Out	Front Speaker Out	Front Speaker Out	Front Speaker Out
Pink	Mic In	Mic In	Mic In	Mic In
Orange	–	–	Center/Subwoofer	Center/Subwoofer
Black	–	Rear Speaker Out	Rear Speaker Ou	Rear Speaker Out
Gray	–	–	–	Side Speaker Out

- 11. USB 2.0 ports 3 and 4.** These 4-pin Universal Serial Bus (USB) ports are available for connecting USB 2.0 devices.
- 12. External SATA port.** This port connects to an external Serial ATA hard disk drive.



The external SATA port supports external SATA 3.0 Gb/s devices. Longer cables support higher power requirements to deliver signal up to two meters away, and enables improved hot-swap function.



To use hot-plug, set the SATA Mode Select in the BIOS settings to [AHCI Mode]. See section **4.3.6 Storage Configuration** for details.

- 13. IEEE 1394a port.** This 6-pin IEEE 1394a port provides high-speed connectivity for audio/video devices, storage peripherals, PCs, or portable devices.
- 14. DVI-D Out port.** This port is for any DVI-D compatible device and is HDCP compliant allowing playback of HD DVD, Blu-Ray and other protected content.



- This motherboard comes with dual-VGA output that features different display on 2 monitors at the same time if you connect 2 monitors to both the onboard VGA and DVI-D out ports.
- DVI-D cannot be converted to output RGB Signal to CRT and is not compatible with DVI-I.
- To play HD DVD or Blu-Ray Disc, make sure to use an HDCP compliant monitor.

15. **HDMI Out port.** This port is for a high-definition multimedia interface (HDMI) connector.



- This motherboard comes with dual-VGA outputs that features different displays on 2 monitors at the same time if you connect 2 monitors to both the onboard VGA and HDMI ports.
- **Playback of HD DVD and Blu-Ray Discs**
The speed and bandwidth of the CPU/Memory, DVD player, and drivers will affect the playback quality. Following is a configuration example for your reference. Using the CPU/Memory of higher speed and bandwidth with the higher-version DVD player and drivers will upgrade the playback quality.

CPU: AMD Athlon64 ADH3200IAA4DE/512KB (single core)
DIMM: Kingston DDR2-800 1G x1 (BIOS share memory: 256MB)
HDD: Seagate ST3160023A (ATA100)
ODD: Sony BWU100A
- To play HD DVD or Blu-Ray Disc, make sure to use an HDCP compliant monitor.

16. **Optical S/PDIF Out port.** This port connects an external audio output device via an optical S/PDIF cable.
17. **USB 2.0 ports 5 and 6.** These 4-pin Universal Serial Bus (USB) ports are available for connecting USB 2.0 devices.

Troubleshooting on HDTV overscaling or underscaling:

If your desktop is extending beyond the viewable display area or the desktop or image is not filling the entire display area while using the onboard HDMI out port and the HDMI cable, you can resize the desktop appearing on your HDTV screen.

To resize your HDTV desktop:

1. Install **AMD Chipset Driver** from the motherboard support DVD. See section **3.3.2 Drivers menu** for details.
 2. Right-click the desktop and select **ATI CATALYST(R) Control Center**.
 3. From the **Graphics Settings** tree, expand **DTV (HDMI™) 1**.
 4. Click **Scaling Options**.
 5. Move the **Underscan/Overscan** slider to adjust the overall size of the display on the HDMI™ DTV.
- Using this slider increases or decreases any black borders that may be visible around the outside of the display.



6. To ensure that forcing a custom display mode through the ATI Displays Manager does not create conflicting resolutions, select the **Use the scaling values instead of the customized settings when the desktop resolution does not match your DFP resolution** check box.



The **Scaling Options** function of the **DTV (HDMI™) 1** item in the ATI CATALYST Control Center is adjustable only when you are using an HDTV compliance resolution such as 480i, 720i, or 1080i.

2.7.2 Internal connectors

1. Floppy disk drive connector (34-1 pin FLOPPY)

This connector is for the provided floppy disk drive (FDD) signal cable. Insert one end of the cable to this connector, then connect the other end to the signal connector at the back of the floppy disk drive.



Pin 5 on the connector is removed to prevent incorrect cable connection when using a FDD cable with a covered Pin 5.

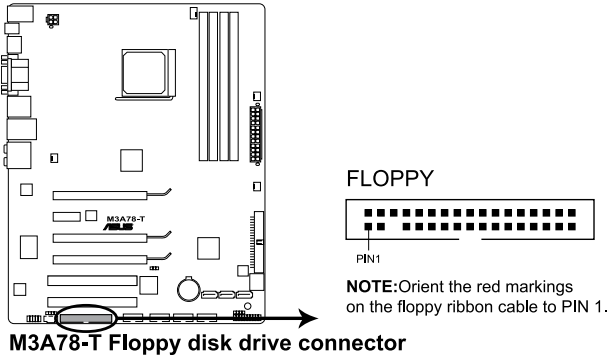

2. IDE connector (40-1 pin PRI_IDE)

The onboard IDE connector is for the Ultra DMA 133/100/66/33 signal cable. There are three connectors on each Ultra DMA 133/100/66/33 signal cable: blue, black, and gray. Connect the blue connector to the motherboard's IDE connector, then select one of the following modes to configure your device.

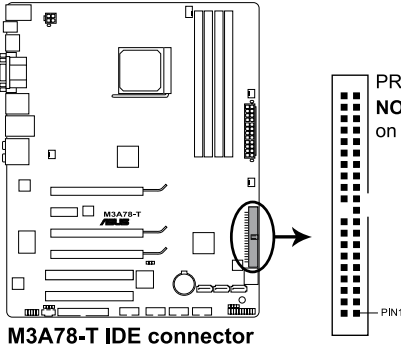

	Drive jumper setting	Mode of device(s)	Cable connector
Single device	Cable-Select or Master	–	Black
Two devices	Cable-Select	Master	Black
		Slave	Gray
	Master	Master	Black or gray
	Slave	Slave	



- Pin 20 on the IDE connector is removed to match the covered hole on the Ultra DMA cable connector. This prevents incorrect insertion when you connect the IDE cable.
- Use the 80-conductor IDE cable for Ultra DMA 133/100/66/33 IDE devices.



If any device jumper is set as “Cable-Select,” make sure all other device jumpers have the same setting.

3. Serial ATA connectors (7-pin SATA1-5)

These connectors are for the Serial ATA signal cables for Serial ATA hard disk and optical disk drives.

If you install Serial ATA hard disk drives, you can create a RAID 0, RAID 1, and RAID 10 configuration through the onboard controller.

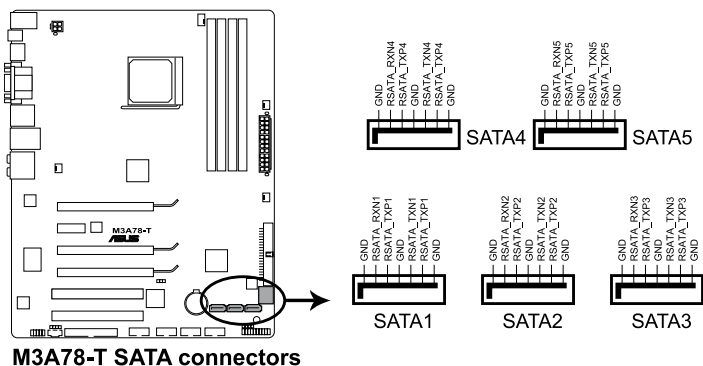

Important note on Serial ATA

Install the Windows® XP Service Pack 1 before using Serial ATA.



- For detailed instructions on how to configure RAID 0, RAID 1, RAID 5 and RAID 10, refer to the RAID manual in the support DVD.
- If you intend to create a Serial ATA RAID set using these connectors, set the **OnChip SATA Type** item in the BIOS to [RAID].



Connect the right-angle side of SATA signal cable to SATA device. Or you may connect the right-angle side of SATA cable to the onboard SATA port to avoid mechanical conflict with huge graphics cards.

right angle side

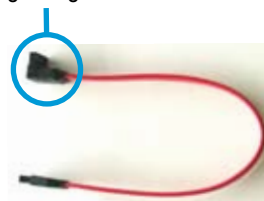

4. USB connectors (10-1 pin USB 78, USB910, USB1112)

These connectors are for USB 2.0 ports. Connect the USB module cable to any of these connectors, then install the module to a slot opening at the back of the system chassis. These USB connectors comply with USB 2.0 specification that supports up to 480 Mbps connection speed.

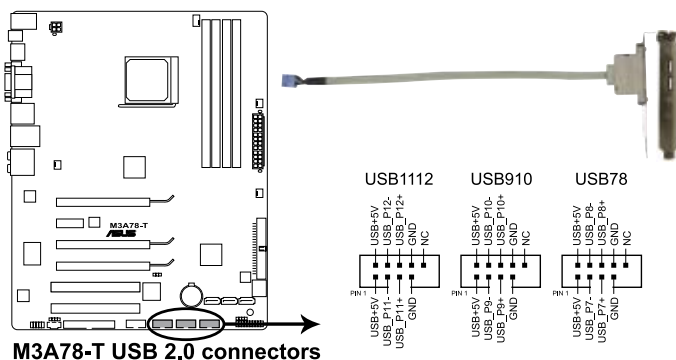

Never connect a 1394 cable to the USB connectors. Doing so will damage the motherboard!



You can connect the front panel USB cable to the ASUS Q-Connector (USB, blue) first, and then install the Q-Connector (USB) to the USB connector onboard if your chassis supports front panel USB ports.

5. IEEE 1394a port connector (10-1 pin IE1394_2)

This connector is for a IEEE 1394a port. Connect the IEEE 1394a module cable to this connector, then install the module to a slot opening at the back of the system chassis.

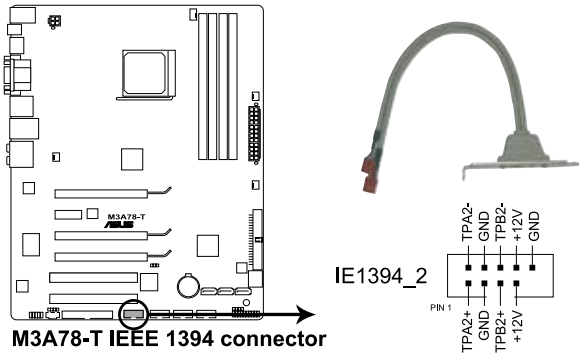

Never connect a USB cable to the IEEE 1394a connector. Doing so will damage the motherboard!



You can connect the front panel 1394 cable to the ASUS Q-Connector (1394, red) first, and then install the Q-Connector (1394) to the 1394 connector onboard if your chassis supports front panel 1394 ports.



The IEEE 1394a module is purchased separately.

6. CPU, chassis, and power fan connectors (4-pin CPU_FAN, 3-pin CHA_FAN1-2, 3-pin PWR_FAN)

The fan connectors support cooling fans of 350 mA~2000 mA (24 W max.) or a total of 1 A~7 A (84 W max.) at +12V. Connect the fan cables to the fan connectors on the motherboard, making sure that the black wire of each cable matches the ground pin of the connector.



Do not forget to connect the fan cables to the fan connectors. Insufficient air flow inside the system may damage the motherboard components. These are not jumpers! Do not place jumper caps on the fan connectors!

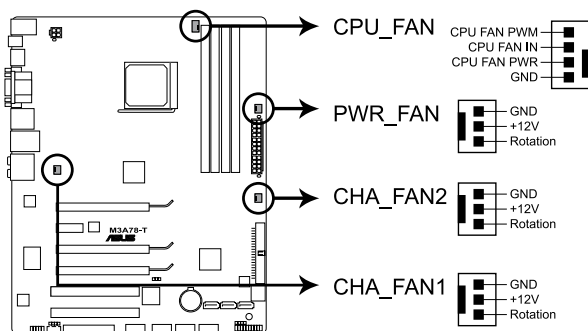

M3A78-T FAN connectors



- Only the CPU_FAN, CHA_FAN1 and CHA_FAN2 connectors support the ASUS Q-Fan 2 feature.
- If you install two graphics cards, we recommend that you plug the rear chassis fan cable to the motherboard connector labeled CHA_FAN1 or CHA_FAN2 for better thermal environment.

7. Chassis intrusion connector (4-1 pin CHASSIS)

This connector is for a chassis-mounted intrusion detection sensor or switch. Connect one end of the chassis intrusion sensor or switch cable to this connector. The chassis intrusion sensor or switch sends a high-level signal to this connector when a chassis component is removed or replaced. The signal is then generated as a chassis intrusion event.

By default, the pin labeled “Chassis Signal” and “Ground” are shorted with a jumper cap. Remove the jumper caps only when you intend to use the chassis intrusion detection feature.

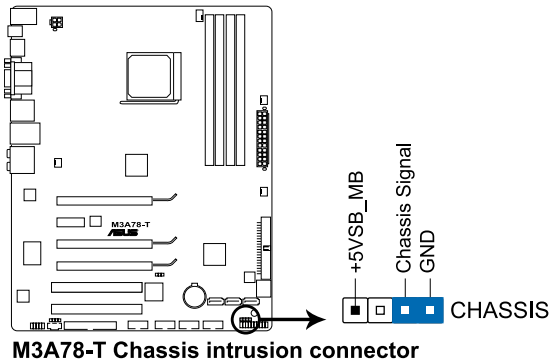

8. ATX power connectors (24-pin EATXPWR; 4-pin ATX12V)

These connectors are for ATX power supply plugs. The power supply plugs are designed to fit these connectors in only one orientation. Find the proper orientation and push down firmly until the connectors completely fit.

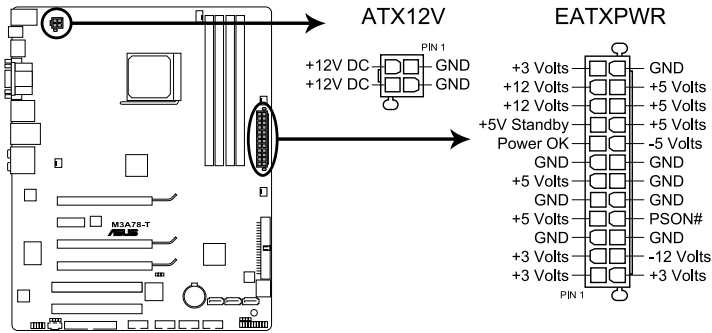

M3A78-T ATX power connectors



- For a fully configured system, we recommend that you use a power supply unit (PSU) that complies with ATX 12 V Specification 2.0 (or later version) and provides a minimum power of 600 W.
- Do not forget to connect the 4-pin ATX +12 V power plug; otherwise, the system will not boot.
- Use of a PSU with a higher power output is recommended when configuring a system with more power-consuming devices. The system may become unstable or may not boot up if the power is inadequate.
- If you are uncertain about the minimum power supply requirement for your system, refer to the **Recommended Power Supply Wattage Calculator** at <http://support.asus.com/PowerSupplyCalculator/PSCalculator.aspx?SLanguage=en-us> for details.
- The ATX 12 V Specification 2.0-compliant (500W) PSU has been tested to support the motherboard power requirements with the following configuration:
CPU: AMD FX-62
Memory 1024 MB DDR2-800 (x4)
Graphics card: PCI Express x16 NVIDIA 7900GTX
Serial ATA device: SATA hard disk drive (x2)
Optical drives: DVD-RW

9. Front panel audio connector (10-1 pin AAFP)

This connector is for a chassis-mounted front panel audio I/O module that supports either HD Audio or legacy AC'97 audio standard. Connect one end of the front panel audio I/O module cable to this connector.

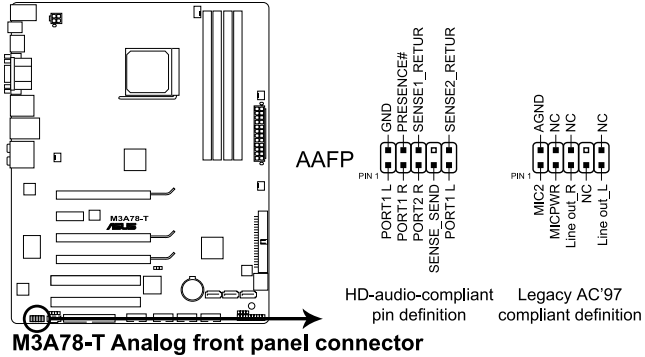

- We recommend that you connect a high-definition front panel audio module to this connector to avail of the motherboard's high-definition audio capability.
- If you want to connect a high-definition front panel audio module to this connector, set the **Front Panel Support Type** item in the BIOS setup to [HD Audio]; if you want to connect an AC'97 front panel audio module to this connector, set the item to [AC97]. By default, this connector is set to [HD Audio].

10. Optical drive audio connector (4-pin CD)

These connectors allow you to receive stereo audio input from sound sources such as a CD-ROM, TV tuner, or MPEG card.

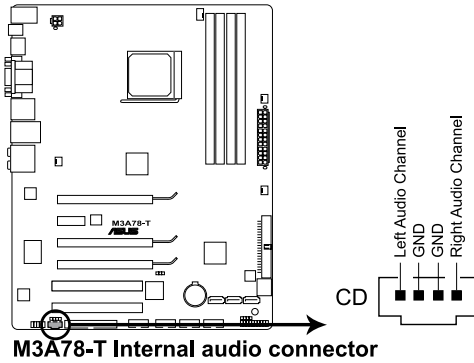

M3A78-T Internal audio connector

11. Digital audio connector (4-1 pin SPDIF_OUT)

This connector is for an additional Sony/Philips Digital Interface (S/PDIF) port(s). Connect the S/PDIF Out module cable to this connector, then install the module to a slot opening at the back of the system chassis.

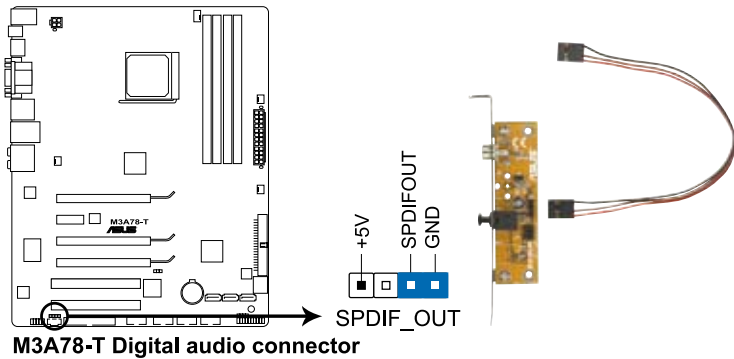

M3A78-T Digital audio connector



The S/PDIF module is purchased separately.

12. System panel connector (20-8 pin PANEL)

This connector supports several chassis-mounted functions.

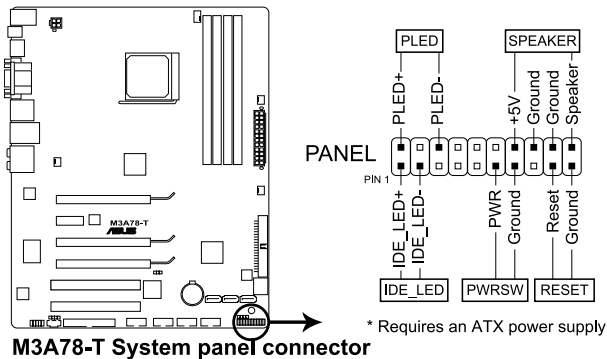

- **System power LED (2-pin PLED)**

This 2-pin connector is for the system power LED. Connect the chassis power LED cable to this connector. The system power LED lights up when you turn on the system power, and blinks when the system is in sleep mode.

- **Hard disk drive activity LED (2-pin IDE_LED)**

This 2-pin connector is for the HDD Activity LED. Connect the HDD Activity LED cable to this connector. The IDE LED lights up or flashes when data is read from or written to the HDD.

- **System warning speaker (4-pin SPEAKER)**

This 4-pin connector is for the chassis-mounted system warning speaker. The speaker allows you to hear system beeps and warnings.

- **ATX power button/soft-off button (2-pin PWR SR)**

This connector is for the system power button. Pressing the power button turns the system on or puts the system in sleep or soft-off mode depending on the BIOS settings. Pressing the power switch for more than four seconds while the system is ON turns the system OFF.

- **Reset button (2-pin RESET)**

This 2-pin connector is for the chassis-mounted reset button for system reboot without turning off the system power.

This chapter describes the power up sequence, the vocal POST messages, and ways of shutting down the system.

Powering up **3**

Chapter summary

3

3.1	Starting up for the first time.....	3-1
3.2	Turning off the computer.....	3-2

3.1 Starting up for the first time

1. After making all the connections, replace the system case cover.
2. Be sure that all switches are off.
3. Connect the power cord to the power connector at the back of the system chassis.
4. Connect the power cord to a power outlet that is equipped with a surge protector.
5. Turn on the devices in the following order:
 - a. Monitor
 - b. External SCSI devices (starting with the last device on the chain)
 - c. System power
6. After applying power, the system power LED on the system front panel case lights up. For systems with ATX power supplies, the system LED lights up when you press the ATX power button. If your monitor complies with “green” standards or if it has a “power standby” feature, the monitor LED may light up or switch between orange and green after the system LED turns on.

The system then runs the power-on self tests or POST. While the tests are running, the BIOS beeps or additional messages appear on the screen. If you do not see anything within 30 seconds from the time you turned on the power, the system may have failed a power-on test. Check the jumper settings and connections or call your retailer for assistance.

BIOS beep codes

BIOS Beep	Description
One short beep	No keyboard detected
One continuous beep followed by two short beeps then a pause (repeated)	No memory detected
One continuous beep followed by three short beeps	No VGA detected
One continuous beep followed by four short beeps	Hardware component failure

7. At power on, hold down the <Delete> key to enter the BIOS Setup..

3.2 Turning off the computer

3.2.1 Using the OS shut down function

If you are using Windows® XP:

1. Click the **Start** button then select **Turn Off Computer**.
2. Click the **Turn Off** button to shut down the computer.
3. The power supply should turn off after Windows® shuts down.

If you are using Windows® Vista™:

1. Click the **Start** button then select **ShutDown**.
2. The power supply should turn off after Windows® shuts down.

3.2.2 Using the dual function power switch

While the system is ON, pressing the power switch for less than four seconds puts the system to sleep mode or to soft-off mode, depending on the BIOS setting. Pressing the power switch for more than four seconds lets the system enter the soft-off mode regardless of the BIOS setting.

This chapter tells how to change the system settings through the BIOS Setup menus. Detailed descriptions of the BIOS parameters are also provided.

BIOS setup 4

4.1	Managing and updating your BIOS	4-1
4.2	BIOS setup program	4-9
4.3	Main menu	4-12
4.4	Advanced menu	4-17
4.5	Power menu	4-31
4.6	Boot menu	4-35
4.7	Tools menu	4-39
4.8	Exit menu	4-42

4.1 Managing and updating your BIOS

The following utilities allow you to manage and update the motherboard Basic Input/Output System (BIOS) setup.

1. **ASUS EZ Flash 2** (Updates the BIOS using a floppy disk, USB Flash, or the motherboard support DVD during POST.)
2. **ASUS AFUDOS** (Updates the BIOS in DOS mode using a bootable floppy disk.)
3. **ASUS Update** (Updates the BIOS in Windows® environment.)

Refer to the corresponding sections for details on these utilities.



Save a copy of the original motherboard BIOS file to a bootable floppy disk in case you need to restore the BIOS in the future. Copy the original motherboard BIOS using the ASUS Update or AFUDOS utilities.

4.1.1 Creating a bootable floppy disk

1. Do either one of the following to create a bootable floppy disk.

DOS environment

- a. Insert a 1.44MB floppy disk into the drive.
- b. At the DOS prompt, type **format A:/S** then press <Enter>.

Windows® XP environment

- a. Insert a 1.44 MB floppy disk to the floppy disk drive.
- b. Click **Start** from the Windows® desktop, then select **My Computer**.
- c. Select the 3 1/2 Floppy Drive icon.
- d. Click **File** from the menu, then select **Format**. A Format 3 1/2 Floppy Disk window appears.
- e. Windows® XP users: Select **Create an MS-DOS startup disk** from the format options field, then click **Start**.

Windows® Vista environment

- a. Insert a formatted, high density 1.44 MB floppy disk to the floppy disk drive.
 - b. Click  from the Windows® desktop, then select **Computer**.
 - c. Right-click **Floppy Disk Drive** then click **Format** to display the **Format 3 1/2 Floppy** dialog box .
 - d. Select the **Create an MS-DOS startup disk** check box.
 - e. Click **Start**.
2. Copy the original or the latest motherboard BIOS file to the bootable floppy disk.

4.1.2 ASUS EZ Flash 2 utility

The ASUS EZ Flash 2 feature allows you to update the BIOS without having to go through the long process of booting from a floppy disk and using a DOS-based utility. The EZ Flash 2 utility is built-in the BIOS chip so it is accessible by pressing <Alt> + <F2> during the Power-On Self-Test (POST).

To update the BIOS using EZ Flash 2:

1. Visit the ASUS website (www.asus.com) to download the latest BIOS file for the motherboard.
2. Save the BIOS file to a floppy disk or a USB flash disk, then restart the system.
3. You can launch the EZ Flash 2 by two methods.
 - (1) Insert the floppy disk / USB flash disk that contains the BIOS file to the floppy disk drive or the USB port.
Press <Alt> + <F2> during POST to display the following.

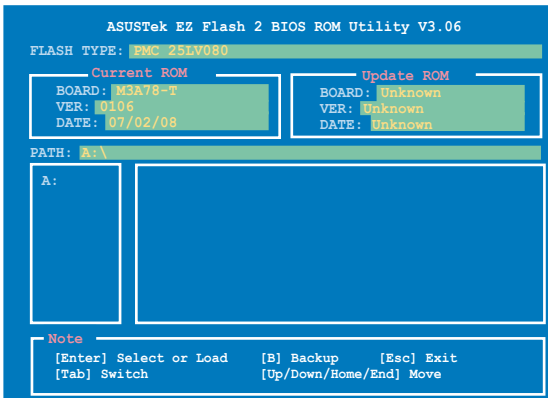

- (2) Enter BIOS setup program. Go to the **Tools** menu to select **EZ Flash 2** and press <Enter> to enable it.
You can switch between drives by pressing <Tab> before the correct file is found. Then press <Enter>.
4. When the correct BIOS file is found, EZ Flash 2 performs the BIOS update process and automatically reboots the system when done.



- This function can support devices such as USB flash disks or floppy disks with **FAT 32/16** format only.
- Do not shut down or reset the system while updating the BIOS to prevent system boot failure!

4.1.3 AFUDOS utility

The AFUDOS utility allows you to update the BIOS file in DOS environment using a bootable floppy disk with the updated BIOS file. This utility also allows you to copy the current BIOS file that you can use as backup when the BIOS fails or gets corrupted during the updating process.

Copying the current BIOS

To copy the current BIOS file using the AFUDOS utility:



- Make sure that the floppy disk is not write-protected and has at least 1024KB free space to save the file.
- The succeeding BIOS screens are for reference only. The actual BIOS screen displays may not be same as shown.

1. Copy the AFUDOS utility (afudos.exe) from the motherboard support DVD to the bootable floppy disk you created earlier.
2. Boot the system in DOS mode, then at the prompt type:

```
afudos /o[filename]
```

where the [filename] is any user-assigned filename not more than eight alphanumeric characters for the main filename and three alphanumeric characters for the extension name.

```
A:\>afudos /oOLDBIOS1.rom
```

Main filename Extension name

3. Press <Enter>. The utility copies the current BIOS file to the floppy disk.

```
A:\>afudos /oOLDBIOS1.rom
AMI Firmware Update Utility - Version 1.19(ASUS V2.07(03.11.24BB))
Copyright (C) 2002 American Megatrends, Inc. All rights reserved.
Reading flash ..... done
Write to file..... ok
A:\>
```

The utility returns to the DOS prompt after copying the current BIOS file.

Updating the BIOS file

To update the BIOS file using the AFUDOS utility:

1. Visit the ASUS website (www.asus.com) and download the latest BIOS file for the motherboard. Save the BIOS file to a bootable floppy disk.



Write the BIOS filename on a piece of paper. You need to type the exact BIOS filename at the DOS prompt.

2. Copy the AFUDOS utility (afudos.exe) from the motherboard support DVD to the bootable floppy disk you created earlier.
3. Boot the system in DOS mode, then at the prompt type:

```
afudos /i[filename]
```

where [filename] is the latest or the original BIOS file on the bootable floppy disk.

```
A:\>afudos /im3A78T.ROM
```

4. The utility verifies the file and starts updating the BIOS.

```
A:\>afudos /im3A78T.ROM
AMI Firmware Update Utility - Version 1.19 (ASUS V2.07 (03.11.24BB))
Copyright (C) 2002 American Megatrends, Inc. All rights reserved.

WARNING!! Do not turn off power during flash BIOS
Reading file ..... done
Reading flash ..... done

Advance Check .....
Erasing flash ..... done
Writing flash ..... 0x0008CC00 (9%)
```



Do not shut down or reset the system while updating the BIOS to prevent system boot failure!

5. The utility returns to the DOS prompt after the BIOS update process is completed. Reboot the system from the hard disk drive.

```
A:\>afudos /im3A78T.ROM
AMI Firmware Update Utility - Version 1.19 (ASUS V2.07 (03.11.24BB))
Copyright (C) 2002 American Megatrends, Inc. All rights reserved.

WARNING!! Do not turn off power during flash BIOS
Reading file ..... done
Reading flash ..... done

Advance Check .....
Erasing flash ..... done
Writing flash ..... done
Verifying flash .... done

Please restart your computer

A:\>
```

4.1.4 ASUS Update utility

The ASUS Update is a utility that allows you to manage, save, and update the motherboard BIOS in Windows® environment. The ASUS Update utility allows you to:

- Save the current BIOS file
- Download the latest BIOS file from the Internet
- Update the BIOS from an updated BIOS file
- Update the BIOS directly from the Internet, and
- View the BIOS version information.

This utility is available in the support DVD that comes with the motherboard package.



ASUS Update requires an Internet connection either through a network or an Internet Service Provider (ISP).

Installing ASUS Update

To install ASUS Update:

1. Place the support DVD in the optical drive. The **Drivers** menu appears.
2. Click the **Utilities** tab, then click **Install ASUS Update**. See page 3-4 for the Utilities screen menu.
3. The ASUS Update utility is copied to your system.



Quit all Windows® applications before you update the BIOS using this utility.

Updating the BIOS through the Internet

To update the BIOS through the Internet:

1. Launch the ASUS Update utility from the Windows® desktop by clicking **Start > Programs > ASUS > ASUSUpdate > ASUSUpdate**. The ASUS Update main window appears.

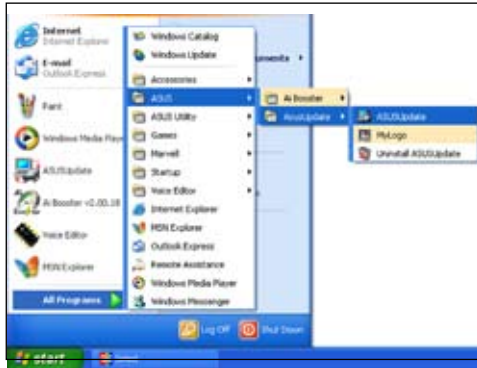

2. Select **Update BIOS from the Internet** option from the drop-down menu, then click **Next**.



3. Select the ASUS FTP site nearest you to avoid network traffic, or click **Auto Select**. Click **Next**.

4. From the FTP site, select the BIOS version that you wish to download. Click **Next**.
5. Follow the screen instructions to complete the update process.



The ASUS Update utility is capable of updating itself through the Internet. Always update the utility to avail all its features.



Updating the BIOS through a BIOS file

To update the BIOS through a BIOS file:

1. Launch the ASUS Update utility from the Windows® desktop by clicking Start > **Programs > ASUS > ASUSUpdate > ASUSUpdate**. The ASUS Update main window appears.
2. Select **Update BIOS from a file** option from the drop-down menu, then click **Next**.



3. Locate the BIOS file from the **Open** window, then click **Open**.
4. Follow the screen instructions to complete the update process.

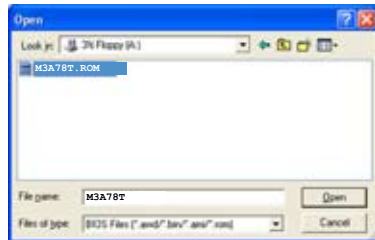

4.2 BIOS setup program

This motherboard supports a programmable firmware chip that you can update using the provided utility described in section **2.1 Managing and updating your BIOS**.

Use the BIOS Setup program when you are installing a motherboard, reconfiguring your system, or prompted to “Run Setup.” This section explains how to configure your system using this utility.

Even if you are not prompted to use the Setup program, you can change the configuration of your computer in the future. For example, you can enable the security password feature or change the power management settings. This requires you to reconfigure your system using the BIOS Setup program so that the computer can recognize these changes and record them in the CMOS RAM of the LPC chip.

The firmware chip on the motherboard stores the Setup utility. When you start up the computer, the system provides you with the opportunity to run this program. Press during the Power-On Self-Test (POST) to enter the Setup utility; otherwise, POST continues with its test routines.

If you wish to enter Setup after POST, restart the system by pressing <Ctrl+Alt+Delete>, or by pressing the reset button on the system chassis. You can also restart by turning the system off and then back on. Do this last option only if the first two failed.

The Setup program is designed to make it as easy to use as possible. Being a menu-driven program, it lets you scroll through the various sub-menus and make your selections from the available options using the navigation keys.



-
- The default BIOS settings for this motherboard apply for most conditions to ensure optimum performance. If the system becomes unstable after changing any BIOS settings, load the default settings to ensure system compatibility and stability. Select the Load Default Settings item under the Exit Menu. See section **4.8 Exit menu**.
 - The BIOS setup screens shown in this section are for reference purposes only, and may not exactly match what you see on your screen.
 - Visit the ASUS website (www.asus.com) to download the latest BIOS file for this motherboard.
-

4.2.1 BIOS menu screen

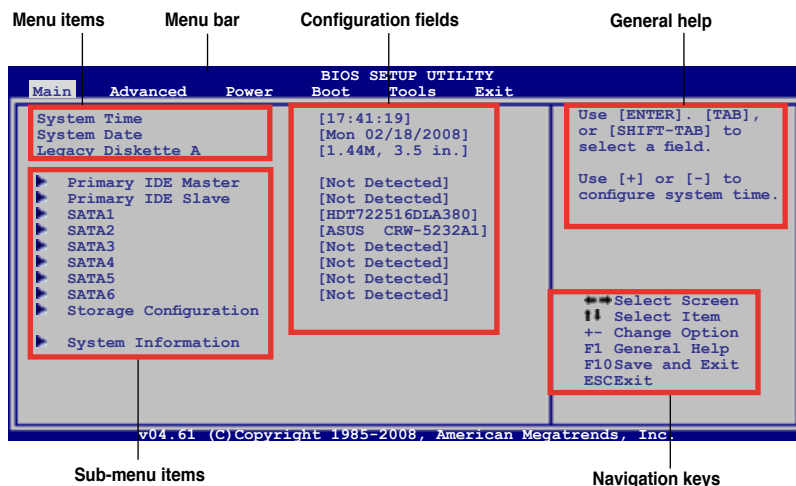

4.2.2 Menu bar

The menu bar on top of the screen has the following main items:

Main	For changing the basic system configuration
Advanced	For changing the advanced system settings
Power	For changing the advanced power management (APM) configuration
Boot	For changing the system boot configuration
Tools	For configuring options for special functions
Exit	For selecting the exit options and loading default settings

To select an item on the menu bar, press the right or left arrow key on the keyboard until the desired item is highlighted.



- The BIOS setup screens shown in this chapter are for reference purposes only, and may not exactly match what you see on your screen.
- Visit the ASUS website (www.asus.com) to download the latest BIOS information.

4.4.3 Navigation keys

At the bottom right corner of a menu screen are the navigation keys for that particular menu. Use the navigation keys to select items in the menu and change the settings.

4.3 Main menu

When you enter the BIOS Setup program, the Main menu screen appears, giving you an overview of the basic system information.



Refer to section 4.2.1 BIOS menu screen for information on the menu screen items and how to navigate through them.

```

BIOS SETUP UTILITY
Main  Advanced  Power  Boot  Tools  Exit
-----
System Time           [17:41:19]
System Date           [Thu 05/15/2008]
Legacy Diskette A    [1.44M, 3.5 in.]

▶ Primary IDE Master   : [Not Detected]
▶ Primary IDE Slave   : [Not Detected]
▶ SATA1                : [HDT722516DLA380]
▶ SATA2                : [ASUS CRW-5232A1]
▶ SATA3                : [Not Detected]
▶ SATA4                : [Not Detected]
▶ SATA5                : [Not Detected]
▶ SATA6                : [Not Detected]
▶ Storage Configuration
▶ System Information

Use [ENTER]. [TAB],
or [SHIFT-TAB] to
select a field.

Use [+] or [-] to
configure system time.

*** Select Screen
↑↓ Select Item
+- Change Option
Tab Select Field
F1 General Help
F10 Save and Exit
ESC Exit

v04.61 (C)Copyright 1985-2008, American Megatrends, Inc.
```

4.3.1 System Time [xx:xx:xx]

Allows you to set the system time.

4.3.2 System Date [Day xx/xx/xxxx]

Allows you to set the system date.

4.3.3 Legacy Diskette A [1.44M, 3.5 in.]

Sets the type of floppy drive installed.

Configuration options: [Disabled] [720K , 3.5 in.] [1.44M, 3.5 in.]

4.3.4 Primary IDE Master/Slave

While entering Setup, the BIOS automatically detects the presence of IDE devices. There is a separate sub-menu for each IDE device. Select a device item then press <Enter> to display the IDE device information.

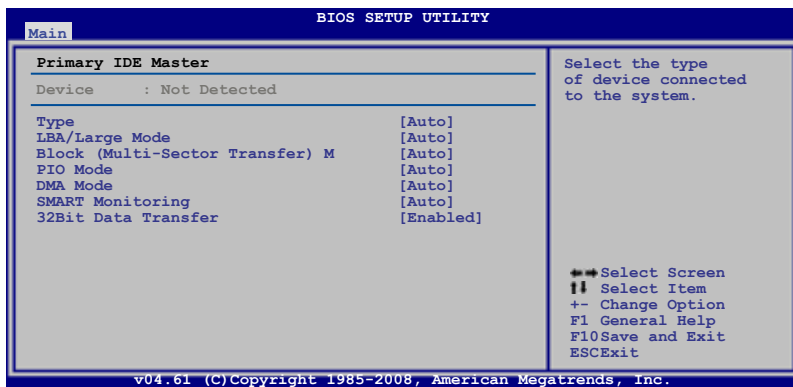

The BIOS automatically detects the values opposite the dimmed items (Device, Vendor, Size, LBA Mode, Block Mode, PIO Mode, Async DMA, Ultra DMA, and SMART monitoring). These values are not user-configurable. These items show N/A if no IDE device is installed in the system.

Type [Auto]

Selects the type of IDE drive. Setting to [Auto] allows automatic selection of the appropriate IDE device type. Select [CDROM] if you are specifically configuring a DVD-ROM drive. Select [ARMD] (ATAPI Removable Media Device) if your device is either a ZIP, LS-120, or MO drive.

Configuration options: [Not Installed] [Auto] [CDROM] [ARMD]

LBA/Large Mode [Auto]

Enables or disables the LBA mode. Setting to [Auto] enables the LBA mode if the device supports this mode, and if the device was not previously formatted with LBA mode disabled. Configuration options: [Disabled] [Auto]

Block (Multi-sector Transfer) M [Auto]

Enables or disables data multi-sectors transfers. When set to [Auto], the data transfer from and to the device occurs multiple sectors at a time if the device supports multi-sector transfer feature. When set to [Disabled], the data transfer from and to the device occurs one sector at a time.

Configuration options: [Disabled] [Auto]

PIO Mode [Auto]

Selects the PIO mode.

Configuration options: [Auto] [0] [1] [2] [3] [4]

DMA Mode [Auto]

Selects the DMA mode. Configuration options: [Auto] [SWDMA0] [SWDMA1] [SWDMA2] [MWDMA0] [MWDMA1] [MWDMA2] [UDMA0] [UDMA1] [UDMA2] [UDMA3] [UDMA4] [UDMA5] [UDMA6]

SMART Monitoring [Auto]

Sets the Smart Monitoring, Analysis, and Reporting Technology. Configuration options: [Auto] [Disabled] [Enabled]

32Bit Data Transfer [Enabled]

Enables or disables 32-bit data transfer. Configuration options: [Disabled] [Enabled]

4.3.5 SATA1/2/3/4/5/6

While entering Setup, the BIOS automatically detects the presence of SATA devices. There is a separate sub-menu for each SATA device. Select a device item then press <Enter> to display the SATA device information.

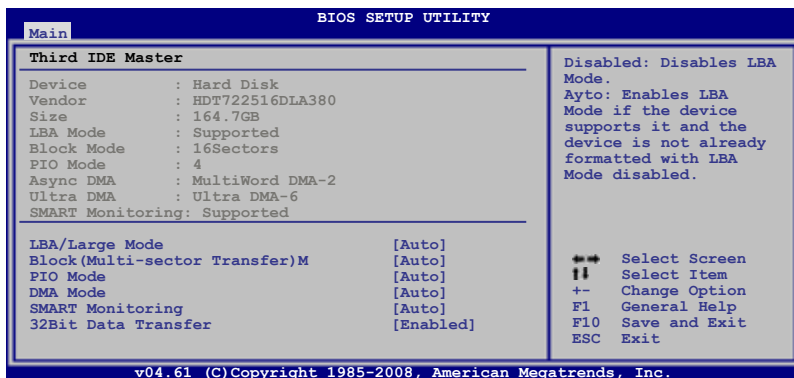

The BIOS automatically detects the values opposite the dimmed items (Device, Vendor, Size, LBA Mode, Block Mode, PIO Mode, Async DMA, Ultra DMA, and SMART monitoring). These values are not user-configurable. These items show N/A if no IDE device is installed in the system.

LBA/Large Mode [Auto]

Enables or disables the LBA mode. Setting to [Auto] enables the LBA mode if the device supports this mode, and if the device was not previously formatted with LBA mode disabled. Configuration options: [Disabled] [Auto]

Block (Multi-sector Transfer) M [Auto]

Enables or disables data multi-sectors transfers. When set to [Auto], the data transfer from and to the device occurs multiple sectors at a time if the device supports multi-sector transfer feature. When set to [Disabled], the data transfer from and to the device occurs one sector at a time.

Configuration options: [Disabled] [Auto]

PIO Mode [Auto]

Selects the PIO mode.

Configuration options: [Auto] [0] [1] [2] [3] [4]

DMA Mode [Auto]

Selects the DMA mode.

Configuration options: [Auto] [SWDMA0] [SWDMA1] [SWDMA2] [MWDMA0] [MWDMA1] [MWDMA2] [UDMA0] [UDMA1] [UDMA2] [UDMA3] [UDMA4] [UDMA5] [UDMA6]

SMART Monitoring [Auto]

Sets the Smart Monitoring, Analysis, and Reporting Technology.

Configuration options: [Auto] [Disabled] [Enabled]

32Bit Data Transfer [Enabled]

Enables or disables 32-bit data transfer.

Configuration options: [Disabled] [Enabled]

4.3.6 Storage Configuration

The Storage Configuration menu allows you to configure your storage device(s). Select an item then press <Enter> to display the sub-menu.

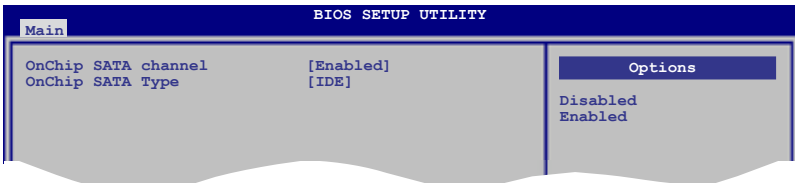

OnChip SATA Channel [Enabled]

Enables or disables OnChip SATA Channel.

Configuration options: [Disabled] [Enabled]

OnChip SATA Type [IDE]

This item appears only when you set the **OnChip SATA Channel** item to [Enabled] and allows you to set the OnChip SATA Type.

Configuration options: [IDE] [RAID] [AHC]



- If you want to use the Serial ATA hard disk drives as Parallel ATA physical storage devices, keep the default setting [IDE].
- If you want the Serial ATA hard disk drives to use the Advanced Host Controller Interface (AHCI), set this item to [AHCI]. The AHCI allows the onboard storage driver to enable advanced Serial ATA features that increases storage performance on random workloads by allowing the drive to internally optimize the order of commands.
- If you want to create a RAID 0, RAID 1, and RAID 10 configuration from the Serial ATA hard disk drives, set this item to [RAID].

4.3.7 System Information

This menu gives you an overview of the general system specifications. The BIOS automatically detects the items in this menu.

```
BIOS SETUP UTILITY
Main
AMIBIOS
Version      :0106
Build Date   :07/02/08

Processor
Brand        :AMD Phenom(tm) 8400 Triple-Core
              Processor
Speed        :2100MHz
Count        :3

System Memory
Installed Size: 1024MB
Usable Size   : 896MB

*** Select Screen
!! Select Item
F1 General Help
F10 Save and Exit
ESC Exit

v04.61 (C)Copyright 1985-2008, American Megatrends, Inc.
```

AMI BIOS

Displays the auto-detected BIOS information.

Processor

Displays the auto-detected CPU specification.

System Memory

Displays the auto-detected system memory.

4.4 Advanced menu

The Advanced menu items allow you to change the settings for the CPU and other system devices.



Take caution when changing the settings of the Advanced menu items. Incorrect field values can cause the system to malfunction.



The configuration options for this chapter vary depending on the CPU and DIMM model you install on the motherboard.

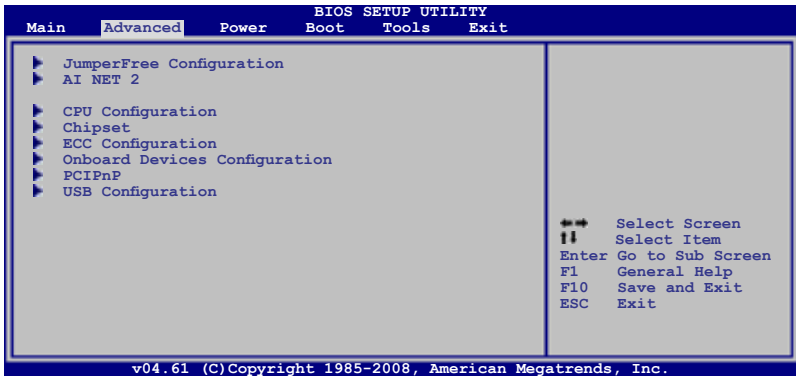

4.4.1 Jumperfree Configuration

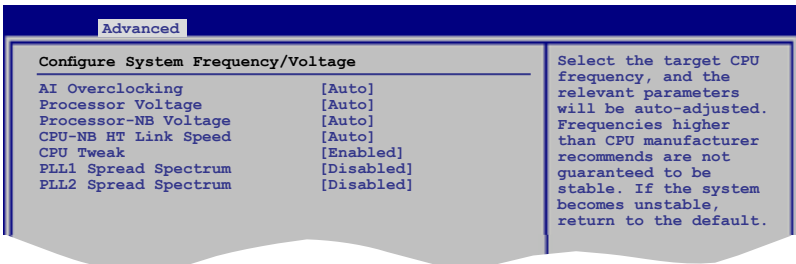

AI Overclocking [Auto]

Allows selection of CPU overclocking options to achieve desired CPU internal frequency. Select any one of the preset overclocking configuration options:

Manual	Allows you to individually set overclocking parameters.
Auto	Loads the optimal settings for the system.
Standard	Loads the standard settings for the system performance.
Overclock Profile	Loads overclocking profiles with optimal parameters for stability when overclocking.



The following item appears only when you set the **Ai Overclocking** item to [Overclock Profile].

Overclock Options [Disabled]

Allows you to set the overclocking options.

Configuration options: [Disabled] [Overclock 3%] [Overclock 5%] [Overclock 10%] [Overclock 15%] [Overclock 20%] [Overclock 30%]



The following two items appear only when you set the **Ai Overclocking** item to [Manual].

FSB Frequency [XXX]

Displays the frequency sent by the clock generator to the system bus and PCI bus. Use the <+> and <-> keys to adjust the FSB frequency. You can also type the desired FSB frequency using the numeric keypad. The values range from 200 to 600.

PCIe Frequency [XXX]

Use the <+> and <-> keys to adjust the PCIe frequency. You can also type the desired PCIe frequency using the numeric keypad. The values range from 100 to 150.



The following item appears only when you set the **Ai Overclocking** item to [Manual], [Standard], or [Overclock Profile].

Processor Frequency Multiplier [Auto]

Allows selection of the processor frequency multiplier.

Configuration options: [Auto] [8.00x] [8.50x] [9.00x] [9.50x] [10.00x] [10.50x]

Processor-NB Frequency Multiplier [Auto]

Allows selection of the processor frequency multiplier.

Configuration options: [Auto] [4.00x] [5.00x] [6.00x] [7.0x] [8.00x] [9.00x]



The following two items are adjusted by typing the desired values using the numeric keypad and press the <Enter> key. You can also use the <+> and <-> keys to adjust the value. To restore the default setting, type [auto] using the keyboard and press the <Enter> key.

Processor Voltage [Auto]

Allows selection of the Processor Voltage. The values range from 0.8000V to 1.6875V with a 0.0125V interval.

Processor-NB Voltage [Auto]

Allows selection of the Processor Voltage. The values range from 0.8000V to 1.6875V with a 0.0125V interval.

CPU-NB HT Link Speed [Auto]

Allows you to set the CPU-Northbridge HyperTransport link speed.

Configuration options: [Auto] [200 MHz] [400 MHz] [600 MHz] [800 MHz] [1 GHz] [1.2 GHz] [1.4 GHz] [1.6 GHz] [1.8 GHz]



The following three items appear only when you set the **Ai Overclocking** item to [Manual], [Standard], or [Overclock Profile] and are adjusted by typing the desired values using the numeric keypad and press the <Enter> key. You can also use the <+> and <-> keys to adjust the value. To restore the default setting, type [auto] using the keyboard and press the <Enter> key.

DDR Voltage [Auto]

Allows selection of the DDR2 reference voltage. The values range from 1.80V to 2.50V with a 0.02V interval.

Southbridge Voltage [Auto]

Allows you to set the Northbridge Voltage.

Configuration options: [Auto] [1.20V] [1.25V] [1.30V] [1.35V]

Northbridge Voltage [Auto]

Allows you to set the Northbridge voltage. The following three items appear when you set **Northbridge Voltage** to [Manual]. Configuration options: [Auto] [Manual]

HyperTransport Voltage [Auto]

You can enter the desired HyperTransport voltage using the numeric keypad. The values range from 1.20V to 1.40V with a 0.02V interval.

Core/PCIe Voltage [Auto]

You can enter the desired Core/PCIe voltage using the numeric keypad. The values range from 1.10V to 1.60V with a 0.02V interval.

CPU Tweak [Enabled]

Allows you to enable or disable the CPU Tweak feature.

Configuration options: [Enabled] [Disabled]

DRAM Timing Configuration

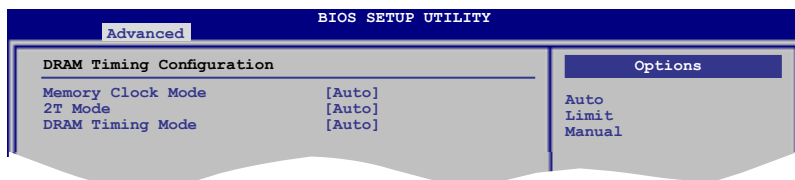

The configuration options for some of the following items vary depending on the DIMMs you install on the motherboard.

Memory Clock Mode [Auto]

Allows selection of the DRAM Frequency programming method.

Configuration options: [Auto] [Limit] [Manual]

Memclock Value [400 MHz]

This sub-item appears only when you set the Memory Clock Mode item to [Limit] and [Manual].

Configuration options: [400 MHz] [533 MHz] [667 MHz] [800 MHz] [1066 MHz]*

2T Mode [Auto]

Allows selection of the 2T Mode.

Configuration options: [Auto] [Disabled] [Enabled]

DRAM Timing Mode [Auto]

Allows selection of the DRAM Timing Mode.

Configuration options: [Auto] [DCT 0] [DCT 1] [Both]



The following sub-items appear only when you set the DRAM Timing Mode item to [DCT 0], [DCT 1], and [Both].

CAS Latency (CL) [Auto]

Configuration options: [Auto] [3 CLK] [4 CLK] [5 CLK] [6 CLK] [7 CLK] [DH_Only]

TCWL [Auto]

Configuration options: [Auto] [5 CLK] [6 CLK] [7 CLK] [8 CLK]

TRCD [Auto]

Configuration options: [Auto] [3 CLK] [4 CLK] [5 CLK] [6 CLK]

TRP [Auto]

Configuration options: [Auto] [3 CLK] [4 CLK] [5 CLK] [6 CLK]

TRAS [Auto]

Configuration options: [Auto]

tWR [Auto]

Configuration options: [Auto] [3 CLK] [4 CLK] [5 CLK] [6 CLK]

tRFC0 [Auto]

Configuration options: [Auto] [75ns] [105ns] [127.5ns] [195ns] [327.5ns]

tRFC1 [Auto]

Configuration options: [Auto] [75ns] [105ns] [127.5ns] [195ns] [327.5ns]

tRFC2 [Auto]

Configuration options: [Auto] [75ns] [105ns] [127.5ns] [195ns] [327.5ns]

tRFC3 [Auto]

Configuration options: [Auto] [75ns] [105ns] [127.5ns] [195ns] [327.5ns]

TRC [Auto]

Configuration options: [Auto]

TRRD [Auto]

Configuration options: [Auto] [2 CLK] [3 CLK] [4 CLK] [5 CLK]

tWTR [Auto]

Specifies the write to read delay when accessing the same DIMM.

Configuration options: [Auto] [1 CLK] [2 CLK] [3 CLK]

tRTP [Auto]

Specifies the read CAS# to precharge time.

Configuration options: [Auto] [2-4 CLK] [3-5 CLK]

PLL1/2 Spread Spectrum [Disabled]

Allows selection of the PLL1/2 Spread Spectrum settings for EMI control.

Configuration options: [Disabled] [Enabled]

4.4.2 AI NET 2

This menu displays the status of the Local Area Network (LAN) cable connected to the LAN (RJ-45) port.

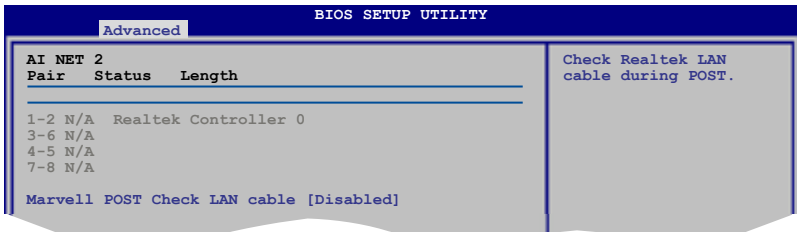

Marvell POST Check LAN cable [Disabled]

Allows you to enable or disable LAN cable check during POST. When enabled, the menu reports the cable faults or shorts, and displays the point (length) where the faults or shorts are detected.

Configuration options: [Disabled] [Enabled]

4.4.3 CPU Configuration

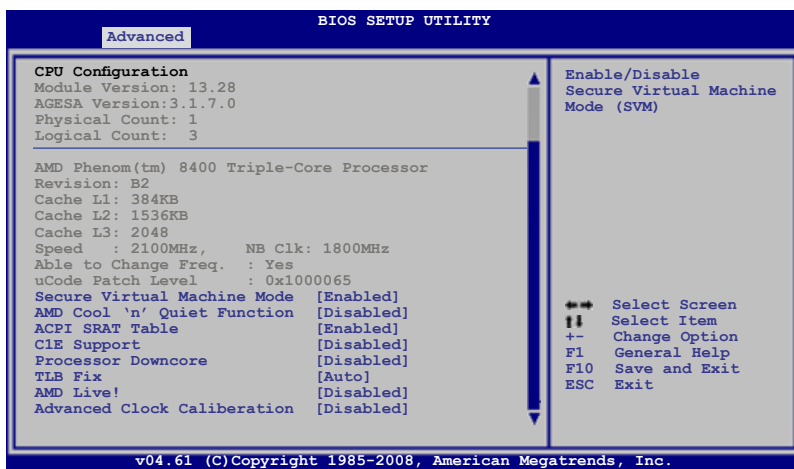

Secure Virtual Machine Mode [Enabled]

Allows you to enable or disable the AMD Secure Virtual Machine mode.

Configuration options: [Disabled] [Enabled]

AMD Cool'n'Quiet Function [Disabled]

Enables or disables the AMD Cool'n'Quiet function.

Configuration options: [Disabled] [Enabled]

ACPI SRAT Table [Enabled]

Enables or disables the building of ACPI SRAT Table.

Configuration options: [Disabled] [Enabled]

C1E Support [Enabled]

Allows you to enable or disable Enhanced Halt State support.

Configuration options: [Disabled] [Enabled]

Processor Downcore [Enabled]

Allows you to enable or disable Enhanced Halt State support.

Configuration options: [Disabled] [Enabled]

TLB Fix [Auto]

Allows you to enable or disable TLB patch for the AMD Phenom processor.

Configuration options: [Auto] [Disabled] [Enabled]

AMD Live! [Disabled]

Enables or disables the AMD Live! technology support.

Configuration options: [Disabled] [Enabled]

Advanced Clock Caliberation [Disabled]

Allows you to set the advanced clock calibration.

Configuration options: [Disabled] [Auto] [All Cores] [Per Core]

4.4.4 Chipset

The Chipset menu allows you to change the advanced chipset settings. Select an item then press <Enter> to display the sub-menu.



PCI Express Configuration

This menu allows you to change the PCI Express Configuration settings. Select an item then press <Enter> to display the sub-menu.

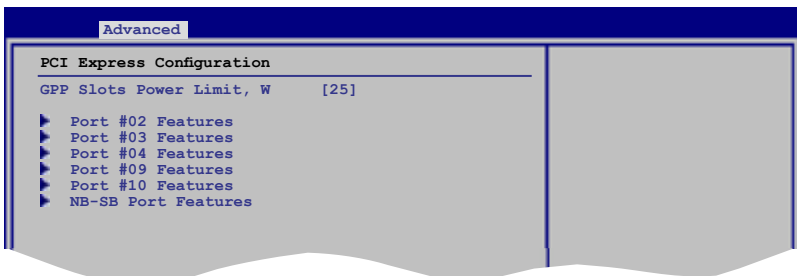

GPP Slots Power Limit, W [25]

Use the <+> and <-> keys to change the value or type the desired value using the numeric keypad. The values range from 0 to 255.

Port #02/03 Features

Gen2 High Speed Mode [Disabled]

Configuration options: [Auto] [Disabled] [Software Initiated] [Advertised RC]

Link ASPM [Disabled]

Configuration options: [Disabled] [L0s] [L1] [L0s & L1]

Link Width [Auto]

Configuration options: [Auto] [x1] [x2] [x4] [x8] [x16]

Slot Power Limit, W [75]

Use the <+> and <-> keys to change the value or type the desired value using the numeric keypad. The values range from 0 to 255.

Port #04/09/10 Features**Gen2 High Speed Mode [Disabled]**

Configuration options: [Auto] [Disabled] [Software Initiated] [Advertised RC]

Link ASPM [Disabled]

Configuration options: [Disabled] [L0s] [L1] [L0s & L1]

NB-SB Port Features**NB-SB link ASPM [Disabled]**

Configuration options: [Disabled] [L1]

NP NB-SB VC1 Traffic Support [Disabled]

Configuration options: [Enabled] [Disabled]

Link Width [Auto]

Configuration options: [Auto] [x1] [x2] [x4]

Internal Graphics Configuration

This menu allows you to change the onboard graphics configuration settings. Select an item then press <Enter> to display the sub-menu.

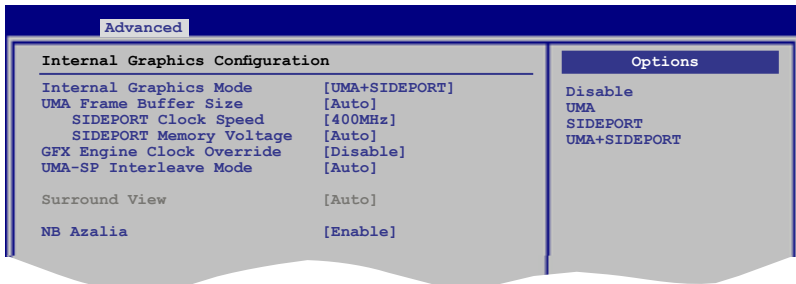
**Internal Graphics Mode [UMA+SIDEPORT]**

Configuration options: [Disable] [UMA] [SIDEPORT] [UMA+SIDEPORT]

UMA Frame Buffer Size [Auto]

Configuration options: [Auto] [32MB] [64MB] [128MB] [256MB] [512MB]

SIDEPORT Clock Speed [667MHz]

Configuration options: [667MHz] [682MHz] [697MHz] [712MHz]...[850MHz]

SIDEPORT Memory Voltage [Auto]

Configuration options: [Auto] [1.60V] [1.70V] [1.80V]

GFX Engine Clock Override [Disable]

Allows you to enable or disable the GFX Engine Clock Override support.

Configuration options: [Disable] [Enable]

GFX Engine Clock [500]

This item appears only when you enable the **GFX Engine Clock Override** item.

Use the <+> and <-> keys to change the value or type the desired value using the numeric keypad. The values range from 150 to 1500.

UMA-SP Interleave Mode [Auto]

Configuration options: [Auto] [Coarse] [Fine]

Surround View [Disabled]

If you set the PCI Express device as the primary display and enable this item, you may use the internal graphics as the secondary display.

Configuration options: [Disabled] [Enable]

NB Azalia [Enable]

Enables or disables the Northbridge Azalia support.

Configuration options: [Disabled] [Enable]

4.4.5 ECC Configuration

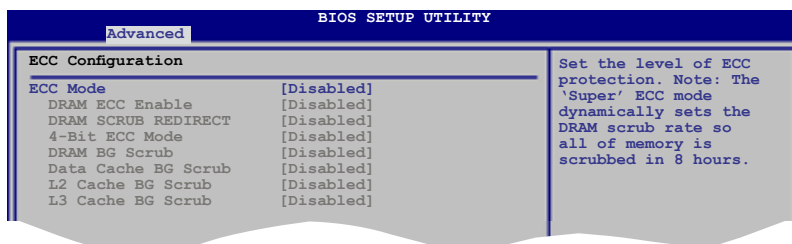

ECC Mode [Disabled]

Disables or sets the DRAM ECC mode that allows the hardware to report and correct memory errors. Set this item to [Basic] [Good] or [Max] to allow ECC mode auto-adjustment. Set this item to [Super] to adjust the **DRAM BG Scrub** sub-item manually. You may also adjust all sub-items by setting this item to [User].

Configuration options: [Disabled] [Basic] [Good] [Super] [Max] [User]

DRAM ECC Enable [Disabled]

Set this item to [Enabled] to allow hardware to report and correct memory errors automatically, maintaining system integrity.

Configuration options: [Disabled] [Enabled]

DRAM SCRUB REDIRECT [Disabled]

Enables or disables the DRAM SCRUB REDIRECT feature that allows the system to correct the DRAM ECC errors immediately when they occur.

Configuration options: [Disabled] [Enabled]

4-Bit ECC Mode [Disabled]

Enables or disables the ECC chip kill feature.

Configuration options: [Disabled] [Enabled]

DRAM BG SCRUB [Disabled]

Disables or sets the DRAM BG Scrub.

Configuration options: [Disabled] [40ns] [80ns] [160ns] [320ns] [640ns] [1.28us] [2.56us] [5.12us] [10.2us] [20.5us] [41.0us] [81.9us] [163.8us] [327.7us] [655.4us] [1.31ms] [4.62ms] [5.24ms] [10.49ms] [20.97ms] [42.00ms] [84.00ms]

Data Cache BG Scrub [Disabled]

Disables or sets the Data Cache BG Scrub. This item allows the L1 Data Cache RAM to be corrected when idle.

Configuration options: [Disabled] [40ns] [80ns] [160ns] [320ns] [640ns] [1.28us] [2.56us] [5.12us] [10.2us] [20.5us] [41.0us] [81.9us] [163.8us] [327.7us] [655.4us] [1.31ms] [4.62ms] [5.24ms] [10.49ms] [20.97ms] [42.00ms] [84.00ms]

L2/L3 Cache BG Scrub [Disabled]

Disables or sets the L2/L3 Cache BG Scrub. This item allows the L2/L3 Data Cache RAM to be corrected when idle.

Configuration options: [Disabled] [40ns] [80ns] [160ns] [320ns] [640ns] [1.28us] [2.56us] [5.12us] [10.2us] [20.5us] [41.0us] [81.9us] [163.8us] [327.7us] [655.4us] [1.31ms] [4.62ms] [5.24ms] [10.49ms] [20.97ms] [42.00ms] [84.00ms]

4.4.6 Onboard Devices Configuration

Advanced	
Onboard Devices Configuraiton	Allows BIOS to Select Serial Port1 Base Addresses.
Serial Port1 Address	[3F8/IRQ4]
HD Audio Azalia Device	[Auto]
Front Panel Support Type	[HD Audio]
SPDIF OUT Mode Setting	[SPDIF Output]
Onboard 1394	[Enabled]
Onboard Marvell Lan	[Enabled]
Onboard Marvell LAN Boot ROM	[Disabled]
Primary Display Adapter	[PCI-E]

Serial Port1 Address [3F8/IRQ4]

Allows you to select the Serial Port1 base address.

Configuration options: [Disabled] [3F8/IRQ4] [2F8/IRQ3] [3E8/IRQ4] [2E8/IRQ3]

HD Audio Azalia Device [Auto]

Allows you to enable or disable the High Definition Audio. The following item appears only when you set this item to [Auto].

Configuration options: [Auto] [Disabled]

Front Panel Support Type [HD Audio]

Allows you to set the front panel audio connector (AAFP) mode to legacy AC'97 or high-definition audio depending on the audio standard that the front panel audio module supports.

Configuration options: [AC97] [HD Audio]

SPDIF_OUT Mode Setting [SPDIF Output]

If your graphics card has HDMI output and needs to use SPDIF signal from the SPDIF_Out header, you need to set to HDMI output for HDMI audio output.

Configuration options: [SPDIF Output] [HDMI Output]

Onboard 1394 [Enabled]

Allows you to enable or disable the onboard 1394 device support.

Configuration options: [Disabled] [Enabled]

Onboard Marvell LAN [Enabled]

Configuration options: [Enable] [Disabled]

Onboard Marvell LAN Boot ROM [Disabled]

This item appears only when you enable the previous item.

Configuration options: [Enable] [Disabled]

Primary Display Adapter [PCI-E]

Allows you to select which graphics controller to use as the primary boot device.

Configuration options: [PCI-E] [PCI] [Onboard]

4.4.7 PCI PnP

The PCI PnP menu items allow you to change the advanced settings for PCI/PnP devices. The menu includes setting IRQ and DMA channel resources for either PCI/PnP or legacy ISA devices, and setting the memory size block for legacy ISA devices.



Take caution when changing the settings of the **PCI PnP** menu items. Incorrect field values can cause the system to malfunction.

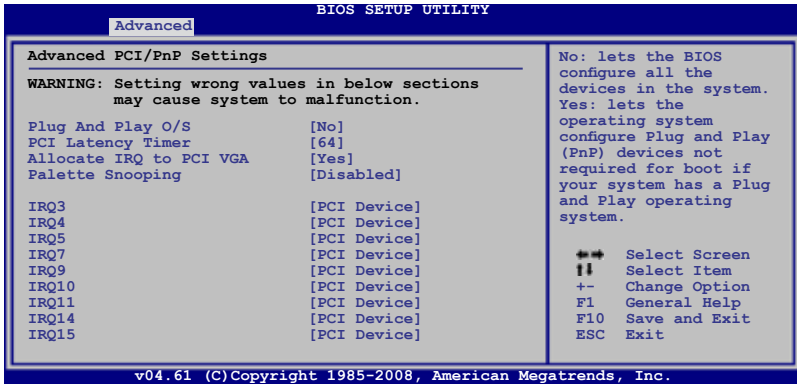

Plug and Play O/S [No]

When set to [No], BIOS configures all the devices in the system. When set to [Yes] and if you install a Plug and Play operating system, the operating system configures the Plug and Play devices not required for boot.

Configuration options: [No] [Yes]

PCI Latency Timer [64]

Allows you to select the value in units of PCI clocks for the PCI device latency timer register.

Configuration options: [32] [64] [96] [128] [160] [192] [224] [248]

Allocate IRQ to PCI VGA [Yes]

When set to [Yes], BIOS assigns an IRQ to PCI VGA card if the card requests for an IRQ. When set to [No], BIOS does not assign an IRQ to the PCI VGA card even if requested.

Configuration options: [No] [Yes]

Palette Snooping [Disabled]

When set to [Enabled], the palette snooping feature informs the PCI devices that an ISA graphics device is installed in the system so that the latter can function correctly.

Configuration options: [Disabled] [Enabled]

IRQ-xx assigned to [PCI Device]

When set to [PCI Device], the specific IRQ is free for use of PCI/PnP devices.

When set to [Reserved], the IRQ is reserved for legacy ISA devices.

Configuration options: [PCI Device] [Reserved]

4.4.8 USB Configuration

The items in this menu allows you to change the USB-related features. Select an item then press <Enter> to display the configuration options.

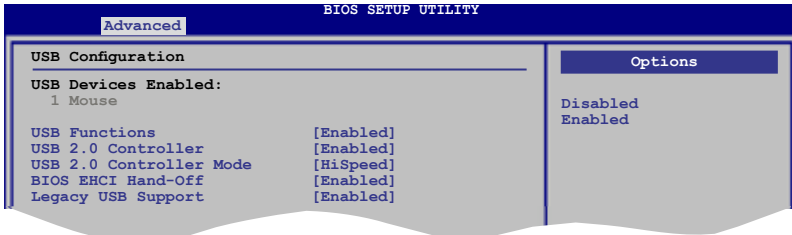

The **USB Devices Enabled** item shows the auto-detected values. If no USB device is detected, the item shows None.

USB Functions [Enabled]

Allows you to enable or disable the USB functions.

Configuration options: [Disabled] [Enabled]



The following item appears only when you set **USB Functions** to [Enabled].

USB 2.0 Controller [Enabled]

Allows you to enable or disable the USB 2.0 controller.

Configuration options: [Enabled] [Disabled]

USB 2.0 Controller Mode [HiSpeed]

Allows you to set the USB 2.0 controller mode to HiSpeed (480 Mbps) or FullSpeed (12 Mbps). Configuration options: [FullSpeed] [HiSpeed]

BIOS EHCI Hand-off [Enabled]

Allows you to enable the support for operating systems without an EHCI hand-off feature. Configuration options: [Disabled] [Enabled]

Legacy USB Support [Enabled]

Allows you to enable or disable the support for legacy USB devices. Setting to [Auto] allows the system to detect the presence of USB devices at startup. If detected, the USB controller legacy mode is enabled. If no USB device is detected, the legacy USB support is disabled.

Configuration options: [Disabled] [Enabled] [Auto]

4.5 Power menu

The Power menu items allow you to change the settings for the Advanced Configuration and Power Interface (ACPI) and the Advanced Power Management (APM). Select an item then press <Enter> to display the configuration options.

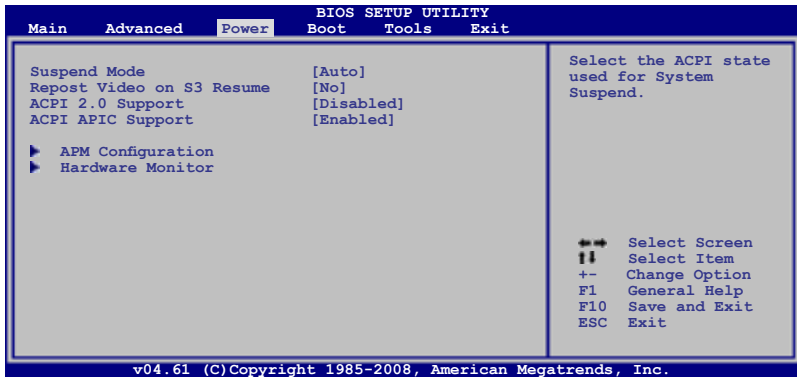

4.5.1 Suspend Mode [Auto]

Allows you to select the Advanced Configuration and Power Interface (ACPI) state to be used for system suspend.

Configuration options: [S1 (POS) Only] [S3 Only] [Auto]

4.5.2 Repost Video on S3 Resume [No]

Determines whether to invoke VGA BIOS POST on S3/STR resume.

Configuration options: [No] [Yes]

4.5.3 ACPI 2.0 Support [Disabled]

Allows you to enable or disable the Advanced Configuration and Power Interface (ACPI) 2.0 support.

Configuration options: [Disabled] [Enabled]

4.5.4 ACPI APIC Support [Enabled]

Allows you to enable or disable the Advanced Configuration and Power Interface (ACPI) support in the Application-Specific Integrated Circuit (ASIC). When set to Enabled, the ACPI APIC table pointer is included in the RSDT pointer list.

Configuration options: [Disabled] [Enabled]

4.5.5 APM Configuration

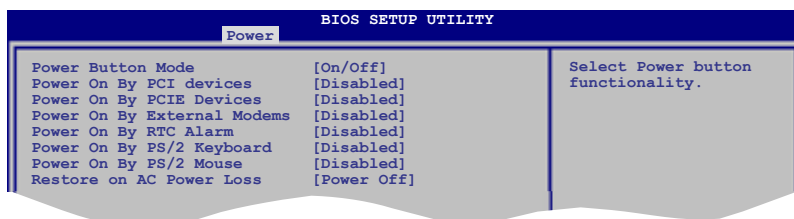

Power Button Mode [On/Off]

Allows you to set the power button function.

Configuration options: [On/Off] [Suspend]

Power On By PCI Devices [Disabled]

Allows you to enable or disable the PME to wake up from S5 by PCI devices.

Configuration options: [Disabled] [Enabled]

Power On By PCIE Devices [Disabled]

Allows you to enable or disable the PCIE devices to generate a wake event.

Configuration options: [Disabled] [Enabled]

Power On By External Modems [Disabled]

This allows either settings of [Enabled] or [Disabled] for powering up the computer when the external modem receives a call while the computer is in Soft-off mode.

Configuration options: [Disabled] [Enabled]



The computer cannot receive or transmit data until the computer and applications are fully running. Thus, connection cannot be made on the first try. Turning an external modem off and then back on while the computer is off causes an initialization string that turns the system power on.

Power On By RTC Alarm [Disabled]

Allows you to enable or disable RTC to generate a wake event. When this item is set to Enabled, the items RTC Alarm Date/ RTC Alarm Hour/ RTC Alarm Minute/ RTC Alarm Second will become user-configurable with set values.

Configuration options: [Disabled] [Enabled]

Power On By PS/2 Keyboard [Disabled]

Allows you to disable the Power On by PS/2 keyboard function or set specific keys on the PS/2 keyboard to turn on the system. This feature requires an ATX power supply that provides at least 1A on the +5VSB lead.

Configuration options: [Disabled] [Space Bar] [Power Key] [Ctrl-Esc]

Power On By PS/2 Mouse [Disabled]

When set to [Enabled], this parameter allows you to use the PS/2 mouse to turn on the system. This feature requires an ATX power supply that provides at least 1A on the +5VSB lead.

Configuration options: [Disabled] [Enabled]

Restore On AC Power Loss [Power Off]

When set to Power Off, the system goes into off state after an AC power loss.

When set to Power On, the system goes on after an AC power loss. When set to Last State, the system goes into either off or on state, whatever the system state was before the AC power loss.

Configuration options: [Power Off] [Power On] [Last State]

4.5.6 Hardware Monitor

BIOS SETUP UTILITY	
Power	
Hardware Monitor	
CPU Temperature	[37°C/98.5°F]
MB Temperature	[39°C/102°F]
CPU Fan Speed	[3292RPM]
Chassis Fan Speed	[N/A]
Power Fan Speed	[N/A]
VCORE Voltage	[1.344V]
3.3V Voltage	[3.280V]
5V Voltage	[4.966V]
12V Voltage	[11.916V]
Smart Q-FAN Function	[Disabled]
CPU Temperature	

CPU Temperature [xxx°C/xxx°F]

MB Temperature [xxx°C/xxx°F]

The onboard hardware monitor automatically detects and displays the motherboard and CPU temperatures. Select Ignored if you do not wish to display the detected temperatures.

CPU / Chassis / Power Fan Speed [xxxxRPM] or [Ignored]

The onboard hardware monitor automatically detects and displays the CPU / Chassis / Power fan speed in rotations per minute (RPM). If the fan is not connected to the motherboard, the field shows N/A. Select Ignored if you do not wish to display the detected speed.

VCORE Voltage, 3.3V Voltage, 5V Voltage, 12V Voltage

The onboard hardware monitor automatically detects the voltage output through the onboard voltage regulators. Select [Ignored] if you do not want to detect this item.

Smart Q-Fan Function [Disabled]

Allows you to enable or disable the ASUS Q-Fan feature that smartly adjusts the fan speeds for more efficient system operation.

Configuration options: [Disabled] [Enabled]



The following items appear only if you set the **Smart Q-Fan Function** to [Enabled].

Smart Q-Fan Profile [Optimal]

Allows you to set the appropriate performance level of the CPU Q-Fan. When set to [Optimal], the CPU fan automatically adjusts depending on the CPU temperature. Set this item to [Silent] to minimize fan speed for quiet CPU fan operation, or [Performance] to achieve maximum CPU fan speed.

Configuration options: [Performance] [Optimal] [Silent]

4.6 Boot menu

The Boot menu items allow you to change the system boot options. Select an item then press <Enter> to display the sub-menu.

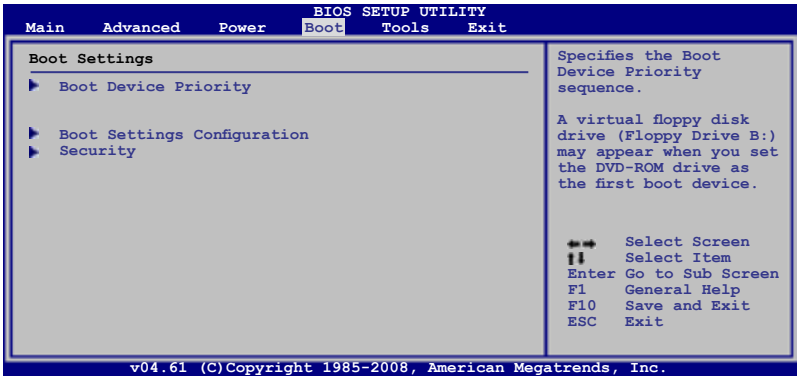

4.6.1 Boot Device Priority

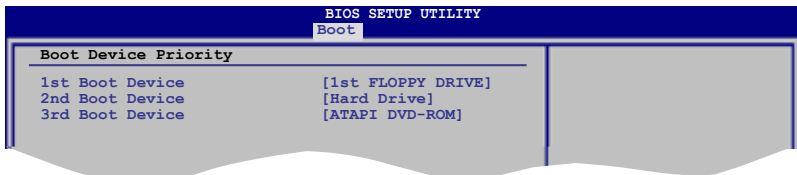

1st ~ xxth Boot Device [1st FLOPPY DRIVE]

These items specify the boot device priority sequence from the available devices. The number of device items that appears on the screen depends on the number of devices installed in the system.

Configuration options: [1st FLOPPY DRIVE] [Hard Drive] [ATAPI DVD-ROM] [Disabled]

4.6.2 Boot Settings Configuration

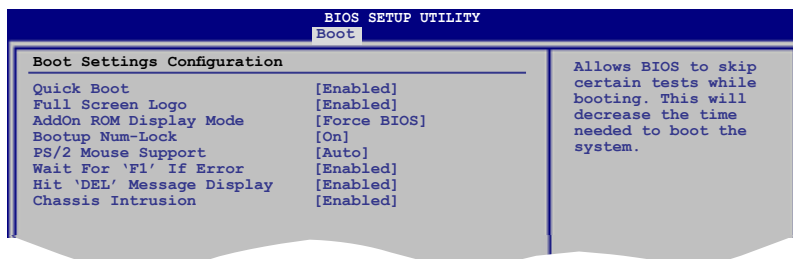

Quick Boot [Enabled]

Enabling this item allows the BIOS to skip some power on self tests (POST) while booting to decrease the time needed to boot the system. When set to [Disabled], BIOS performs all the POST items.

Configuration options: [Disabled] [Enabled]

Full Screen Logo [Enabled]

This allows you to enable or disable the full screen logo display feature.

Configuration options: [Disabled] [Enabled]



Set this item to [Enabled] to use the ASUS MyLogo 2™ feature.

Add On ROM Display Mode [Force BIOS]

Sets the display mode for option ROM.

Configuration options: [Force BIOS] [Keep Current]

Bootup Num-Lock [On]

Allows you to select the power-on state for the NumLock.

Configuration options: [Off] [On]

PS/2 Mouse Support [Auto]

Allows you to enable or disable support for PS/2 mouse.

Configuration options: [Disabled] [Enabled] [Auto]

Wait for 'F1' If Error [Enabled]

When set to Enabled, the system waits for the F1 key to be pressed when error occurs. Configuration options: [Disabled] [Enabled]

Hit 'DEL' Message Display [Enabled]

When set to Enabled, the system displays the message "Press DEL to run Setup" during POST. Configuration options: [Disabled] [Enabled]

Chassis Intrusion [Enabled]

Configuration options: [Disabled] [Enabled]

4.6.3 Security

The Security menu items allow you to change the system security settings. Select an item then press <Enter> to display the configuration options.

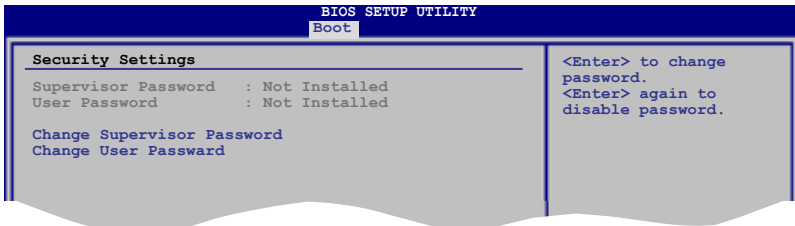

Change Supervisor Password

Select this item to set or change the supervisor password. The Supervisor Password item on top of the screen shows the default Not Installed. After you set a password, this item shows Installed.

To set a Supervisor Password:

1. Select the Change Supervisor Password item and press <Enter>.
2. From the password box, type a password composed of at least six letters and/or numbers, then press <Enter>.
3. Confirm the password when prompted.

The message "Password Installed" appears after you successfully set your password.

To change the supervisor password, follow the same steps as in setting a user password.

To clear the supervisor password, select the Change Supervisor Password then press <Enter>. The message "Password Uninstalled" appears.



If you forget your BIOS password, you can clear it by erasing the CMOS Real Time Clock (RTC) RAM. See section **1.9 Jumpers** for information on how to erase the RTC RAM.

After you have set a supervisor password, the other items appear to allow you to change other security settings.

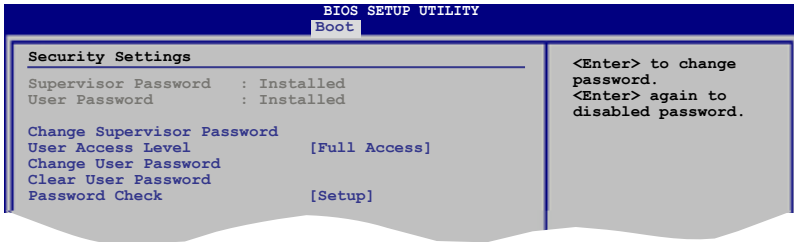

User Access Level [Full Access]

This item allows you to select the access restriction to the Setup items.
Configuration options: [No Access] [View Only] [Limited] [Full Access]

No Access prevents user access to the Setup utility.

View Only allows access but does not allow change to any field.

Limited allows changes only to selected fields, such as Date and Time.

Full Access allows viewing and changing all the fields in the Setup utility.

Change User Password

Select this item to set or change the user password. The User Password item on top of the screen shows the default Not Installed. After you set a password, this item shows Installed.

To set a User Password:

1. Select the **Change User Password** item and press <Enter>.
2. On the password box that appears, type a password composed of at least six letters and/or numbers, then press <Enter>.
3. Confirm the password when prompted.

The message "Password Installed" appears after you set your password successfully.

To change the user password, follow the same steps as in setting a user password.

Clear User Password

Select this item to clear the user password.

Password Check [Setup]

When set to [Setup], BIOS checks for user password when accessing the Setup utility. When set to [Always], BIOS checks for user password both when accessing Setup and booting the system.

Configuration options: [Setup] [Always]

4.7 Tools menu

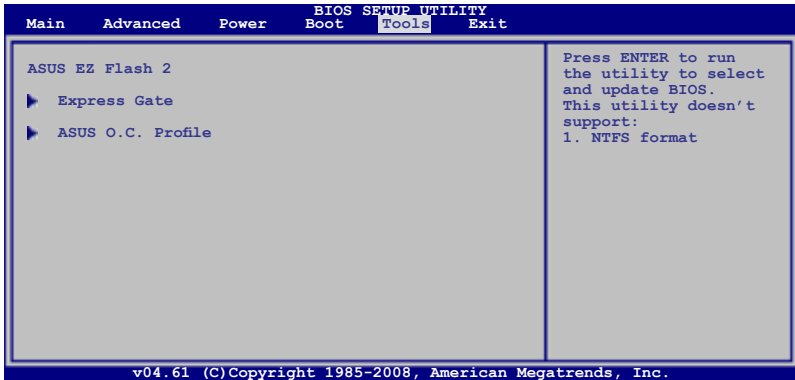

4.7.1 ASUS EZ Flash 2

Allows you to run ASUS EZ Flash 2. When you press <Ok>, a confirmation message appears. Use the left/right arrow key to select between [Yes] or [No], then press <Ok> to confirm your choice.

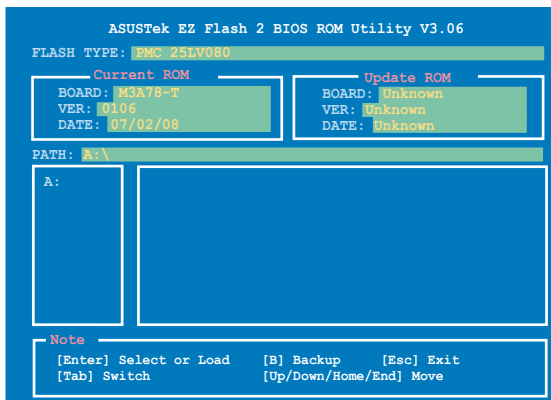

4.7.2 Express Gate

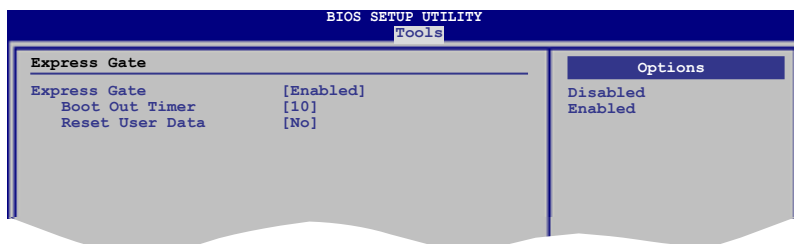

You have to install the ASUS Express Gate application from the support DVD first before you can enable this feature. See page 3-5 for details.

Express Gate [Enabled]

Allows you to enable or disable the ASUS Express Gate feature. ASUS Express Gate is a unique instant-on environment that provides quick access to the Internet browser and Skype.

Configuration options: [Enabled] [Disabled]

Boot Out Timer [10]

Sets countdown duration that the system waits at the Express Gate's first screen before starting Windows or other installed OS. Choose [Disabled] to stay at the first screen of Express Gate for user action.

Configuration options: [Disabled] [1 second] ~ [30 seconds]



The time length is adjusted by typing the desired values using the numeric keypad and press the <Enter> key.

Reset User Data [No]

Allows you to clear Express Gate's user data.

Configuration options: [No] [Reset]

When setting this item to [Reset], make sure to save the setting to the BIOS so that the user data will be cleared the next time you enter the Express Gate. User data includes the Express Gate's settings as well as any personal information stored by the web browser (bookmarks, cookies, browsing history, etc.). This is useful in the rare case where corrupt settings prevent the Express Gate environment from launching properly.



The first time wizard will run again when you enter the Express Gate environment after clearing its settings.

4.7.3 ASUS O.C. Profile

This item allows you to store or load multiple BIOS settings.

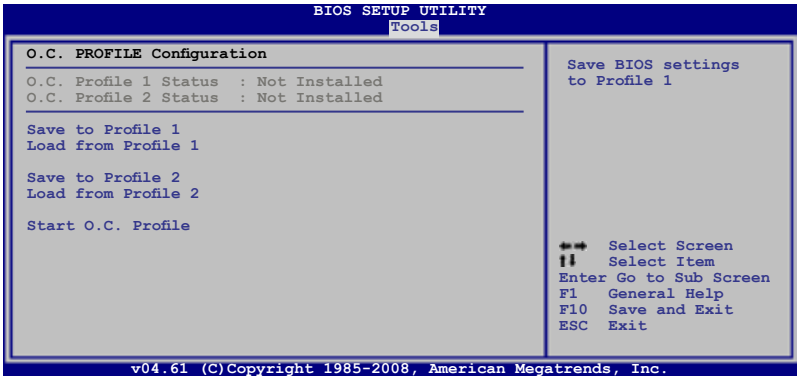

Save to Profile 1/2

Allows you to save the current BIOS file to the BIOS Flash. Press <Enter> to save the file.

Load from Profile 1/2

Allows you to load the previous BIOS settings saved in the BIOS Flash. Press <Enter> to load the file.

Start O.C. Profile

Allows you to run the utility to save and load CMOS. Press <Enter> to run the utility.

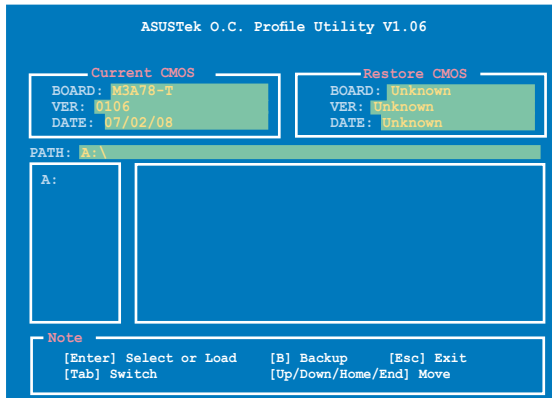

- This function can support devices such as a USB flash disk or a floppy disk with FAT 32/16 format and single partition only.
- DO NOT shut down or reset the system while updating the BIOS to prevent the system boot failure!

4.8 Exit menu

The Exit menu items allow you to load the optimal or failsafe default values for the BIOS items, and save or discard your changes to the BIOS items.

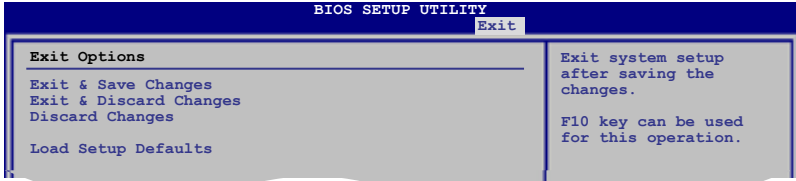

Pressing <Esc> does not immediately exit this menu. Select one of the options from this menu or <F10> from the legend bar to exit.

Exit & Save Changes

Once you are finished making your selections, choose this option from the Exit menu to ensure the values you selected are saved to the CMOS RAM. An onboard backup battery sustains the CMOS RAM so it stays on even when the PC is turned off. When you select this option, a confirmation window appears. Select **Ok** to save changes and exit.



If you attempt to exit the Setup program without saving your changes, the program prompts you with a message asking if you want to save your changes before exiting. Press <Enter> to save the changes while exiting.

Exit & Discard Changes

Select this option only if you do not want to save the changes that you made to the Setup program. If you made changes to fields other than System Date, System Time, and Password, the BIOS asks for a confirmation before exiting.

Discard Changes

This option allows you to discard the selections you made and restore the previously saved values. After selecting this option, a confirmation appears. Select **Ok** to discard any changes and load the previously saved values.

Load Setup Defaults

This option allows you to load the default values for each of the parameters on the Setup menus. When you select this option or if you press <F5>, a confirmation window appears. Select **OK** to load default values. Select **Exit & Save Changes** or make other changes before saving the values to the non-volatile RAM.

This chapter describes the contents of the support DVD that comes with the motherboard package.

5 Software support

5.1	Installing an operating system	5-1
5.2	Support DVD information	5-1
5.3	Software information	5-9
5.4	RAID configurations	5-44
5.5	Creating a RAID driver disk.....	5-51

5.1 Installing an operating system

This motherboard supports Windows® XP/64-bit XP/Vista/64-bit Vista operating systems (OS). Always install the latest OS version and corresponding updates to maximize the features of your hardware.



- Motherboard settings and hardware options vary. Use the setup procedures presented in this chapter for reference only. Refer to your OS documentation for detailed information.
- Make sure that you install Windows® 2000 Service Pack 4 or the Windows® XP Service Pack 2 or later versions before installing the drivers for better compatibility and system stability.

5.2 Support DVD information

The support DVD that came with the motherboard package contains the drivers, software applications, and utilities that you can install to avail all motherboard features.



The contents of the support DVD are subject to change at any time without notice. Visit the ASUS website(www.asus.com) for updates.

5.2.1 Running the support DVD

Place the support DVD to the optical drive. The DVD automatically displays the Drivers menu if Autorun is enabled in your computer.



Click an icon to display support DVD/motherboard information

Click an item to install



If Autorun is NOT enabled in your computer, browse the contents of the support DVD to locate the file ASSETUP.EXE from the BIN folder. Double-click the ASSETUP.EXE to run the DVD.

5.2.2 Drivers menu

The drivers menu shows the available device drivers if the system detects installed devices. Install the necessary drivers to activate the devices.



ASUS InstAll - Installation Wizard for Anti-Virus and drivers

Installs all of the drivers and the Anti-Virus utility through the installation wizard.

Norton Internet Security 2008

Installs the Norton® Internet Security 2008 software.

AMD Cool 'n' Quiet Driver

Installs the AMD® Cool 'n' Quiet™ technology driver.

Realtek Audio Driver

Installs the Realtek® ALC1200 audio driver and application.

AMD Chipset Driver

Installs the AMD® chipset driver.

Marvell Yukon Gigabit Ethernet Driver

Installs the Marvell® Yukon Gigabit Ethernet driver.

5.2.3 Utilities menu

The Utilities menu shows the applications and other software that the motherboard supports.



Click to display the next page



Click to return to the previous page

ASUS InstAll - Installation Wizard for Utilities

Installs all of the utilities through the Installation Wizard.

AMD OverDrive Utility (AOD)

Installs the AMD OverDrive utility.

Marvell Yukon VCT Application

Installs the Marvell® Yukon Virtual Cable Tester™ (VCT) application that diagnoses and reports LAN cable faults and shorts using the Time Domain Reflectometry (TDR) technology.

Marvell Yukon NCU Application

Installs the Marvell® Yukon Virtual Cable Tester™ (VCT) application that diagnoses and reports LAN cable faults and shorts using the Time Domain Reflectometry (TDR) technology.

ASUS Cool'n'Quiet Utility

This item installs the ASUS Cool'n'Quiet utility.

ASUS Update

Allows you to download the latest version of the BIOS from the ASUS website.



Before using the ASUS Update, make sure that you have an Internet connection so you can connect to the ASUS website.

ASUS PC Probe II

This smart utility monitors the fan speed, CPU temperature, and system voltages, and alerts you of any detected problems. This utility helps you keep your computer in healthy operating condition.

ASUS AI Suite

Installs the ASUS AI Suite.

ASUS Express Gate Installer

Allows you to Install or update ASUS Express Gate functions.

Adobe Acrobat Reader 8

Installs the Adobe® Acrobat® Reader that allows you to open, view, and print documents in Portable Document Format (PDF).

Microsoft DirectX 9.0c

Installs the Microsoft® DirectX 9.0 driver. The Microsoft DirectX® 9.0 is a multimedia technology that enhances computer graphics and sound. DirectX® improves the multimedia features of your computer so you can enjoy watching TV and movies, capturing videos, or playing games in your computer. Visit the Microsoft website (www.microsoft.com) for updates.

Ulead Burn.Now

Installs the Ulead Burn.Now application for Audio DVD, CD and data disc creation.

Corel MediaOne Starter

Installs the Corel MediaOne Starter application to easily manage, edit share and protect your multimedia data.

CyberLink PowerBackup

Installs CyberLink PowerBackup to back up and restore your data easily.

Ulead PhotoImpact 12 SE

Installs the PhotoImpact image editing software.

Winzip 11

Installs the Winzip utility for easy file-compression and protection.

Norton Internet Security 2008

Installs the Norton® Internet Security 2008 software.

5.2.4 Make Disk menu

The Make Disk menu contains items to create the ATI® force™ RAID/AHCI driver disk.



ATI RAID/AHCI 32/64bit WinXP/Vista Driver

Allows you to create ATI RAID/AHCI driver disks for 32/64bit Windows® XP/Vista.

5.2.5 Manual menu

The Manual menu contains a list of supplementary user manuals. Click an item to open the folder of the user manual.



Most user manual files are in Portable Document Format (PDF). Install the Adobe® Acrobat® Reader from the Utilities menu before opening a user manual file.



5.2.6 ASUS Contact information

Click the Contact tab to display the ASUS contact information. You can also find this information on the inside front cover of this user guide.

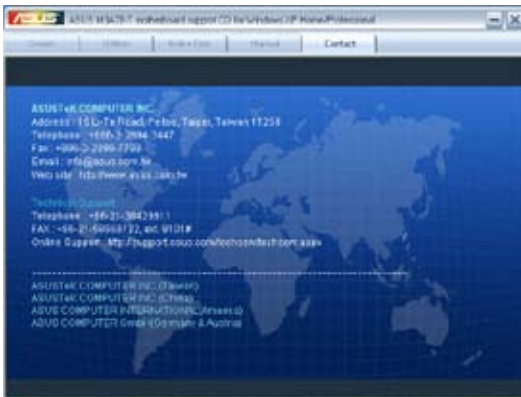

Technical support Form

Displays the ASUS Technical Support Request Form that you have to fill out when requesting technical support.

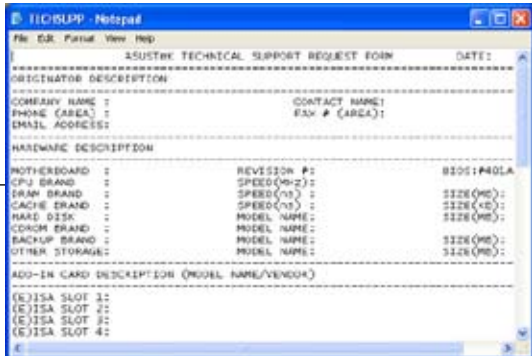

ASUSTEK TECHNICAL SUPPORT REQUEST FORM

ORIGINATOR: _____ DATE: _____

DESCRIPTION: _____

CONTACT NAME: _____

PHONE (AREA): _____ FAX # (AREA): _____

EMAIL ADDRESS: _____

HARDWARE DESCRIPTION

MOTHERBOARD: _____ REVISION: P: _____ BIOS: P401A

CPU BRAND: _____ SPEED (MHz): _____

RAM BRAND: _____ SPEED (MHz): _____ SIZE (MB): _____

CACHE BRAND: _____ SPEED (MHz): _____ SIZE (KB): _____

HARD DISK: _____ MODEL NAME: _____ SIZE (MB): _____

CDROM BRAND: _____ MODEL NAME: _____

BACKUP BRAND: _____ MODEL NAME: _____ SIZE (MB): _____

OTHER STORAGE: _____ MODEL NAME: _____ SIZE (MB): _____

ADD-IN CARD DESCRIPTION (MODEL NAME/VENDOR)

(E)ISA SLOT 3: _____

(E)ISA SLOT 2: _____

(E)ISA SLOT 1: _____

(E)ISA SLOT 4: _____

File list

Displays the contents of the support DVD and a brief description of each in text format.



ASUS_TSP.exe

ASUS_TSP.chm

ASUS_TSP.inf

ASUS_TSP.msi

ASUS_TSP.ppt

ASUS_TSP.rtf

ASUS_TSP.xls

ASUS_TSP.zip

ASUS_TSP.tar.gz

ASUS_TSP.rar

ASUS_TSP.iso

ASUS_TSP.exe

ASUS_TSP.chm

ASUS_TSP.inf

ASUS_TSP.msi

ASUS_TSP.ppt

ASUS_TSP.rtf

ASUS_TSP.xls

ASUS_TSP.zip

ASUS_TSP.tar.gz

ASUS_TSP.rar

ASUS_TSP.iso

5.3 Software information

Most of the applications in the support DVD have wizards that will conveniently guide you through the installation. View the online help or readme file that came with the software application for more information.

5.3.1 ASUS MyLogo2™

The ASUS MyLogo2™ utility lets you customize the boot logo. The boot logo is the image that appears on screen during the Power-On Self-Tests (POST). The ASUS MyLogo2™ is automatically installed when you install the ASUS Update utility from the support DVD. See section 5.2.3 Utilities menu for details.



- Before using the ASUS MyLogo2™, use the AFUDOS utility to make a copy of your original BIOS file, or obtain the latest BIOS version from the ASUS website. See section 4.1.3 AFUDOS utility.
- Make sure that the BIOS item Full Screen Logo is set to [Enabled] if you wish to use ASUS MyLogo2. See section 4.6.2 Boot Settings Configuration.
- You can create your own boot logo image in GIF format.
- The file size should be smaller than 150 K.

To launch the ASUS MyLogo2™:

1. Launch the ASUS Update utility. Refer to section 4.1.1 ASUS Update utility for details.
2. Select **Options** from the drop down menu, then click **Next**.
3. Check the option **Launch MyLogo** to replace system boot logo before flashing BIOS, then click **Next**.
4. Select **Update BIOS** from a file from the drop down menu, then click **Next**.
5. When prompted, locate the new BIOS file, then click **Next**. The ASUS MyLogo window appears.
6. From the left window pane, select the folder that contains the image you intend to use as your boot logo.

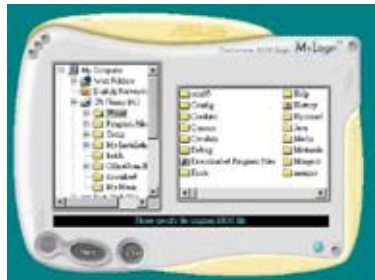

5.3.2 Cool 'n' Quiet!™ Technology

The motherboard supports the AMD Cool 'n' Quiet!™ Technology that dynamically and automatically change the CPU speed, voltage, and amount of power depending on the task the CPU performs.

Enabling Cool 'n' Quiet!™ Technology

To enable Cool 'n' Quiet!™ Technology:

1. Turn on the system and enter BIOS by pressing the key during the Power On Self-Tests (POST).
2. Go to **Advanced > CPU Configuration > AMD Cool 'n'Quiet Function** and set it to [Enabled]. See section 4.4 **Advanced menu**.
3. Save your changes and exit BIOS Setup.
4. Reboot your computer and set your Power Option Properties depending on your operating system.

Windows® XP

1. From the Windows® XP operating system, click **Start**. Select **Settings > Control Panel**.
2. Make sure the Control Panel is set to **Classic View**.
3. Double-click the **Display** icon in the Control Panel then select the **Screen Saver** tab.
4. Click the **Power** button. The following dialogue box appears.
5. From the Power schemes combo list box, select **Minimal Power Management**.
6. Click **OK** to effect settings.

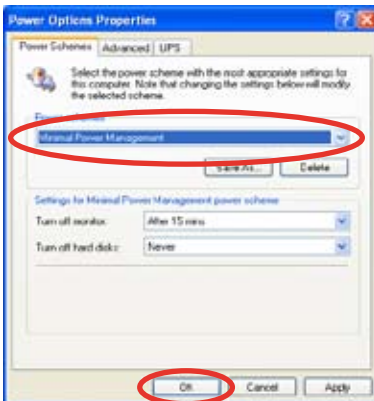

Windows® Vista

1. From the Windows® Vista operating system, click **Start**. Select **Control Panel**.
2. Make sure the Control Panel is set to **Classic View**.
3. Double-click the **Personalization** icon in the Control Panel then click the **Screen Saver** item.
4. Click “**Change power settings...**”. The following dialogue box appears.
5. From the Preferred plans, select **Power saver**.
6. Close all windows.

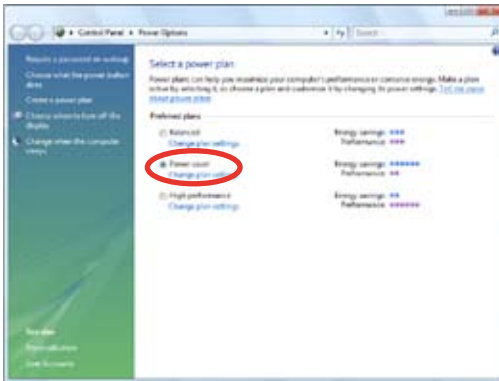

-
- Make sure to install the AMD Cool 'n' Quiet!™ driver and application before using this feature.
 - The AMD Cool 'n' Quiet!™ technology feature works only with the AMD heatsink and fan assembly with monitor chip
 - If you purchased a separate heatsink and fan package, use the ASUS Q-Fan technology feature to automatically adjust the CPU fan speed according to your system loading.
-

Launching the Cool 'n' Quiet!™ software

The motherboard support CD/DVD includes the Cool 'n' Quiet!™ software that enables you to view your system's real-time CPU Frequency and voltage.



Make sure to install the Cool 'n' Quiet!™ software from the motherboard support CD/DVD. Refer to section **5.2.3 Utilities menu** for details.

To launch the Cool 'n' Quiet!™ program:

1. If you are using Windows® XP, click the **Start** button. Select **Programs > ASUS > Cool & Quiet > Cool & Quiet**.
2. If you are using Windows® Vista, click the **Start** button. Select **All Programs > ASUS > Cool & Quiet > Cool & Quiet**.
3. The Cool 'n' Quiet!™ technology screen appears and displays the current CPU Frequency and CPU Voltage.

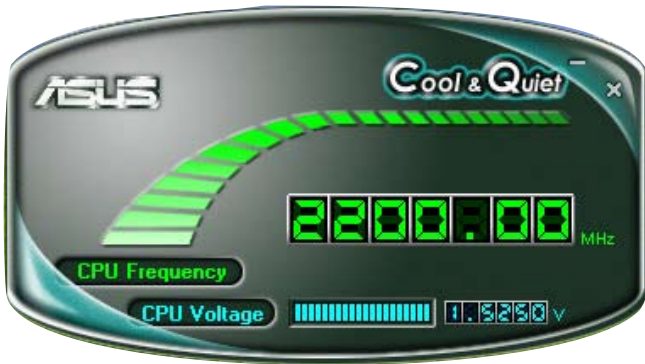

Information

Click the **Information** button () to display information about the audio driver version, DirectX version, audio controller, audio codec, and language setting.



Device advanced settings

Click **Device advanced settings** to show further settings for the playback and recording device.

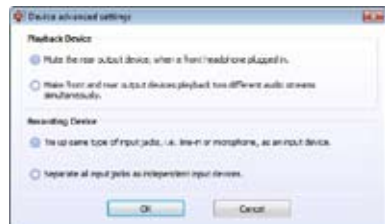

Connector settings

Click the **Connector Settings** button () to show further settings for the analog/digital output/input ports.



Exit

Click the **Exit** button or the **OK** button () to exit the Realtek HD Audio Manager.

Configuration options

Click any of the tabs in this area to configure your audio settings.



In the Windows Vista™ environment, Realtek HD Audio Manager automatically detects devices connected to the analog/digital ports and shows corresponding configuration options tabs.

Digital Output

The Realtek® audio CODEC allows you to connect an external audio output device via the coaxial/digital S/PDIF port. You can set your listening environment, set the karaoke, or select pre-programmed equalizer settings for your listening pleasure.

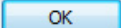

To set the digital output options

1. From the Realtek HD Audio Manager, click the **Digital Output** tab.
2. Click **Set Default Device** to set the digital output port as the default audio output device.
3. Click the **Sound Effects** sub-tab for options on changing the acoustic environment and karaoke settings, or click the **Default Format** sub-tab for options on changing the default audio output format.
4. Click  to effect the Digital Output settings and exit.

Speakers

The **Speakers** tab allows you to configure audio output settings using the analog audio ports.

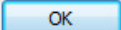

To set the speakers options

1. From the Realtek HD Audio Manager, click the **Speakers** tab.
2. Click **Set Default Device** to set the analog ports as the default audio output device.
3. Click the **Speaker Configuration** sub-tab for audio channel options and test.
4. Click the **Sound Effects** sub-tab for options on changing the acoustic environment and karaoke settings.
5. Click the **Room Correction** sub-tab for individual speaker distance adjustment.
6. Click the **Default Format** sub-tab for options on changing the default audio output format.
7. Click  to effect the Speakers settings and exit.

Line In

The **Line In** tab allows you to configure audio input settings using the analog line in port.

To set the analog line in options

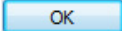
1. From the Realtek HD Audio Manager, click the **Line In** tab.
2. Click **Set Default Device** to set the analog line in port as the default audio input device.
3. The Line In tab allows you to adjust the recording and playback volume and set a default format for audio input.
4. Click  to effect the Line In settings and exit.



Microphone

The **Microphone** tab allows you to configure the audio input settings using the analog microphone port and to check if your microphone device is connected properly.

To set the Microphone options

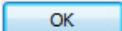
1. From the Realtek HD Audio Manager, click the **Microphone** tab.
2. In the **Microphone Effects** sub-tab, click the **Noise Suppression** option button to reduce the static background noise when recording. Click the **Acoustic Echo Cancellation** option button to reduce the echo from the front speakers when recording. Click the **Beam Forming** option button to eliminate surrounding noise interferences.
3. Click the **Default Format** sub-tab for options on changing the default audio input format.
4. Click  to effect the Microphone settings and exit.



B. Realtek HD Audio Manager for Windows XP™



Information

Click the information button () to display information about the audio driver version, DirectX version, audio controller, audio codec, and language setting.



Minimize

Click the minimize button () to minimize the window.

Exit

Click the exit button () to exit the Realtek HD Audio Manager.

Configuration options

Click any of the tabs in this area to configure your audio settings.

Sound Effect

The Realtek® audio CODEC allows you to set your listening environment, adjust the equalizer, set the karaoke, or select pre-programmed equalizer settings for your listening pleasure.

To set the sound effect options

1. From the Realtek HD Audio Manager, click the **Sound Effect** tab.
2. Click the shortcut buttons or the drop-down menus for options on changing the acoustic environment, adjust the equalizer, or set the karaoke to your desired settings.
3. Click  to effect the Sound Effect settings and exit.



Mixer

The Mixer option allows you to configure audio output (playback) volume and audio input (record) volume.

To set the mixer options

1. From the Realtek HD Audio Manager, click the **Mixer** tab.
2. Turn the volume buttons to adjust the Playback and/or Record volume.



The Mixer option activates voice input from all channels by default. Make sure to set all channels to mute () if you do not want voice input.

3. Make adjustments to Wave, SW Synth, Front, Rear, CD volume, Mic volume, Line Volume, and Stereo mix, etc. by clicking the control tabs and dragging them up and down until you get the desired levels.



Click the next button () to display more menu options.

4. Click  to effect the Mixer settings and exit.

Audio I/O

The Audio I/O option allows you configure your input/output settings.

To set the Audio I/O options

1. From the Realtek HD Audio Manager, click the **Audio I/O** tab.
2. Click the drop-down menu to select the channel configuration.
3. The control settings window displays the status of connected devices. Click  for analog and digital options.
4. Click <OK> to effect the Audio I/O settings and exit



Microphone

The Microphone option allows you configure your input/output settings and to check if your audio devices are connected properly.

To set the Microphone options



1. From the Realtek HD Audio Manager, click the **Microphone** tab.
2. Click the **Noise Suppression** option button to reduce the static background noise when recording.
3. Click the **Acoustic Echo Cancellation** option button to reduce the echo from the front speakers when recording.
4. Click the **Beam Forming** option button to eliminate surrounding noise interferences. Click  to start microphone calibration.
5. Click  to effect the Microphone settings and exit.



3D Audio Demo

The 3D Audio Demo option gives you a demonstration of the 3D audio feature.

To start the 3D Audio Demo

1. From the Realtek HD Audio Manager, click the **3D Audio Demo** tab.
2. Click the option buttons to change the sound, moving path, or environment settings.
3. Click  to test your settings.
4. Click  to effect the 3D Audio Demo settings and exit.



5.3.4 ASUS PC Probe II

PC Probe II is a utility that monitors the computer's vital components, and detects and alerts you of any problem with these components. PC Probe II senses fan rotations, CPU temperature, and system voltages, among others. Because PC Probe II is software-based, you can start monitoring your computer the moment you turn it on. With this utility, you are assured that your computer is always at a healthy operating condition. Refer to page 1-9 for the OS that supports this utility.

Installing PC Probe II

To install PC Probe II on your computer:

1. Place the support DVD to the optical drive. The Drivers installation tab appears if your computer has an enabled Autorun feature.



If Autorun is not enabled in your computer, browse the contents of the support DVD to locate the setup.exe file from the ASUS PC Probe II folder. Double-click the **setup.exe** file to start installation.

2. Click the **Utilities** tab, then click **ASUS PC Probe II**.
3. Follow the screen instructions to complete installation.

Launching PC Probe II

You can launch the PC Probe II right after installation or anytime from the Windows® desktop.

To launch the PC Probe II from the Windows® desktop, click **Start > All Programs > ASUS > PC Probe II > PC Probe II v1.xx.xx**. The PC Probe II main window appears.

After launching the application, the PC Probe II icon appears in the Windows® taskbar. Click this icon to close or restore the application.









Using PC Probe II

Main window

The PC Probe II main window allows you to view the current status of your system and change the utility configuration. By default, the main window displays the Preference section. You can close or restore the Preference section by clicking on the triangle on the main window right handle.



Click to close the Preference panel

Button	Function
	Opens the Configuration window
	Opens the Report window
	Opens the Desktop Management Interface window
	Opens the Peripheral Component Interconnect window
	Opens the Windows Management Instrumentation window
	Opens the hard disk drive, memory, CPU usage window
	Shows/Hides the Preference section
	Minimizes the application
	Closes the application

Sensor alert

When a system sensor detects a problem, the main window right handle turns red, as the illustrations below show.

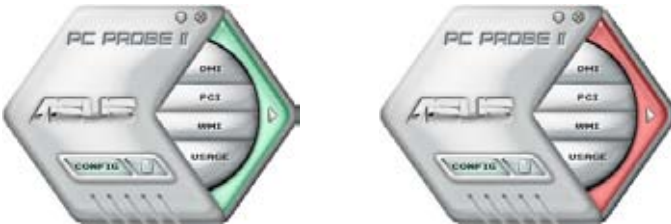

When displayed, the monitor panel for that sensor also turns red. Refer to the Monitor panels section for details.

Preference

You can customize the application using the Preference section in the main window. Click the box before each preference to activate or deactivate.

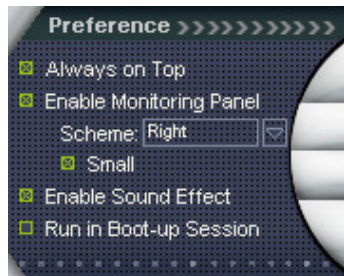

Hardware monitor panels

The hardware monitor panels display the current value of a system sensor such as fan rotation, CPU temperature, and voltages.

The hardware monitor panels come in two display modes: hexagonal (large) and rectangular (small). When you check the Enable Monitoring Panel option from the Preference section, the monitor panels appear on your computer's desktop.



Large display



Small display

Changing the monitor panels position

To change the position of the monitor panels in the desktop, click the arrow down button of the Scheme options, then select another position from the list box. Click OK when finished.



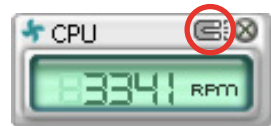

Moving the monitor panels

All monitor panels move together using a magnetic effect. If you want to detach a monitor panel from the group, click the horseshoe magnet icon. You can now move or reposition the panel independently.



Adjusting the sensor threshold value

You can adjust the sensor threshold value in the monitor panel by clicking the  or  buttons. You can also adjust the threshold values using the Config window.

You cannot adjust the sensor threshold values in a small monitoring panel.

Click to increase value

Click to decrease value



Monitoring sensor alert

The monitor panel turns red when a component value exceeds or is lower than the threshold value. Refer to the illustrations below.



Large display



Small display

WMI browser

Click **WMI** to display the WMI (Windows Management Instrumentation) browser. This browser displays various Windows® management information. Click an item from the left panel to display on the right panel. Click the plus sign (+) before WMI Information to display the available information.



You can enlarge or reduce the browser size by dragging the bottom right corner of the browser.

DMI browser

Click **DMI** to display the DMI (Desktop Management Interface) browser. This browser displays various desktop and system information. Click the plus sign (+) before DMI Information to display the available information.



PCI browser

Click **PCI** to display the PCI (Peripheral Component Interconnect) browser. This browser provides information on the PCI devices installed on your system. Click the plus sign (+) before the PCI Information item to display available information.



Usage

The Usage browser displays real-time information on the CPU, hard disk drive space, and memory usage. Click **USAGE** to display the Usage browser.

CPU usage

The CPU tab displays real-time CPU usage in line graph representation. If the CPU has an enabled Hyper-Threading, two separate line graphs display the operation of the two logical processors.



Hard disk drive space usage

The Hard Disk tab displays the used and available hard disk drive space. The left panel of the tab lists all logical drives. Click a hard disk drive to display the information on the right panel. The pie chart at the bottom of the window represents the used (blue) and the available HDD



Memory usage

The Memory tab shows both used and available physical memory. The pie chart at the bottom of the window represents the used (blue) and the available physical memory.



Configuring PC Probe II

Click **CONFIG** to view and adjust the sensor threshold values.

The Config window has two tabs: Sensor/Threshold and Preference. The Sensor/Threshold tab enables you to activate the sensors or to adjust the sensor threshold values. The Preference tab allows you to customize sensor alerts, or change the temperature scale.



Loads the default threshold values for each sensor

Applies your changes

Cancels or ignores your changes

Loads your saved configuration
 Saves your configuration

5.3.5 ASUS AI Suite

ASUS AI Suite allows you to launch AI Gear 2, AI Booster, AI Nap, and Q-Fan 2 utilities easily.

Installing AI Suite

To install AI Suite on your computer:

1. Place the support DVD to the optical drive. The Drivers installation tab appears if your computer has an enabled Autorun feature.
2. Click the Utilities tab, then click **AI Suite**.
3. Follow the screen instructions to complete installation.

Launching AI Suite

You can launch the AI Suite right after installation or anytime from the Windows® desktop.

To launch the AI Suite from the Windows® desktop, click **Start > All Programs > ASUS > AI Suite > AI Suite v1.xx.xx**. The AI Suite main window appears.

After launching the application, the AI Suite icon appears in the Windows® taskbar. Click this icon to close or restore the application.

Using AI Suite

Click the AI Gear 2, AI Nap, AI Booster, or Q-Fan 2 icon to launch the utility, or click the Normal icon to restore the system to normal state.

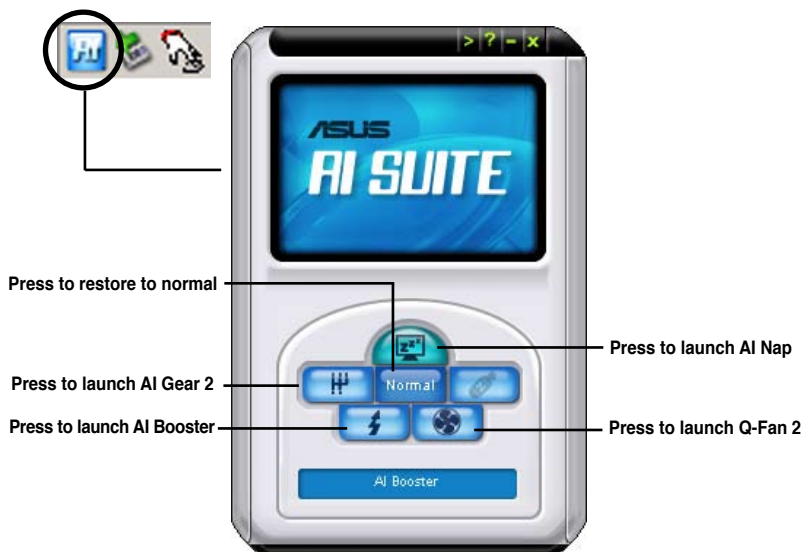

Other feature buttons

Click  on right corner of the main window to open the monitor window.

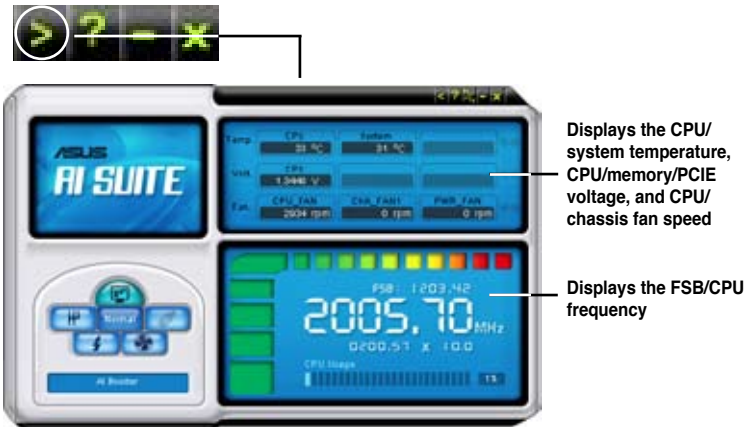

Click  on right corner of the expanded window to switch the temperature from degrees Centigrade to degrees Fahrenheit.



5.3.6 ASUS AI Gear 2

ASUS AI Gear 2 provides four system performance options that allows you to select the best performance setting for your computing needs. This easy-to-use utility adjusts the processor frequency and vCore voltage to minimize system noise and power consumption.

After installing AI Suite from the bundled support DVD, you can launch AI Gear 2 by double-clicking the AI Suite icon on your Windows OS taskbar and then click the AI Gear 2 button on the AI Suite main window.

Shift the gear to the performance setting that you like.

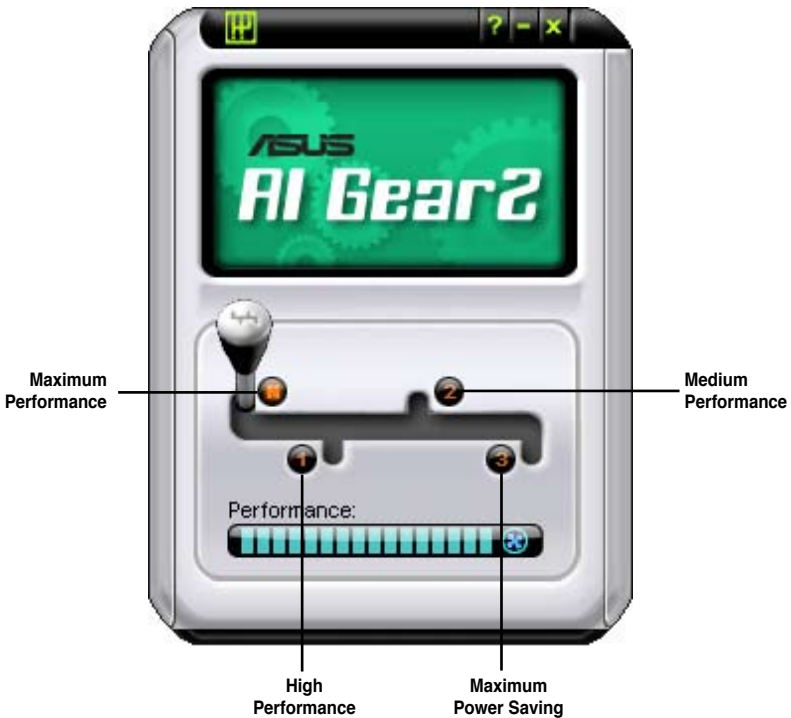

5.3.7 ASUS AI Nap

This feature allows you to minimize the power consumption of your computer whenever you are away. Enable this feature for minimum power consumption and a more quiet system operation.

After installing AI Suite from the bundled support DVD, you can launch the utility by double-clicking the AI Suite icon on the Windows OS taskbar and click the AI Nap button on the AI Suite main window.

Click **Yes** on the confirmation screen.

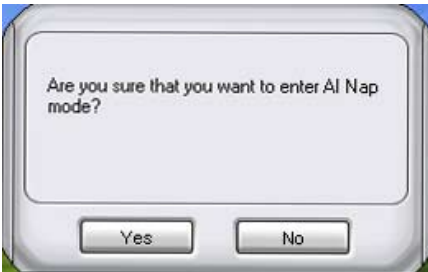

To exit AI Nap mode, press the system power or mouse button then click **Yes** on the confirmation screen.

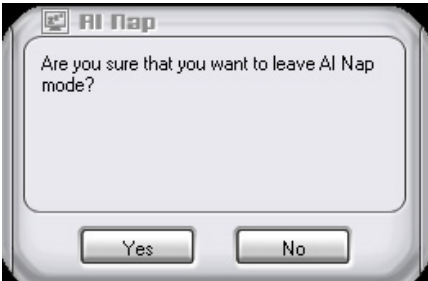

To switch the power button functions from AI Nap to shutting down, just right click the **AI Suite** icon on the OS taskbar, select **AI Nap** and click **Use power button**. Unclick the the item to switch the function back.

5.3.8 ASUS Q-Fan 2

This ASUS Q-Fan 2 Control feature allows you to set the appropriate performance level of the CPU Q-Fan 2 or the Chassis Q-Fan 2 for more efficient system operation. After enabling the Q-Fan 2 function, the fans can be set to automatically adjust depending on the temperature, to decrease fan speed, or to achieve the maximum fan speed.

After installing AI Suite from the bundled support DVD, you can launch the utility by double-clicking the AI Suite icon on the Windows® OS taskbar and click the Q-Fan 2 button on the AI Suite main window.

Click the drop-down menu button and display the fan names. Select **CPU Q-Fan 2** or **CHASSIS Q-Fan 2**. Click the box of **Enable Q-Fan 2** to activate this function.



Profile list appears after clicking the **Enable Q-Fan 2** box. Click the drop-down list button and select a profile. **Optimal** mode makes the fans adjust speed with the temperature; **Silent** mode minimizes fan speed for quiet fan operation; **Performance** mode boosts the fan to achieve maximal fan speed for the best cooling effect.

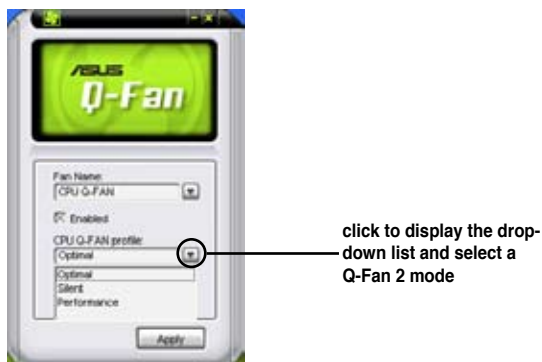

Click **Apply** at the bottom to save the setup.

5.3.9 ASUS AI Booster

The ASUS AI Booster application allows you to overclock the CPU speed in Windows® environment without the hassle of booting the BIOS.

After installing AI Suite from the bundled support DVD, you can launch the utility by double-clicking the AI Suite icon on the Windows® OS taskbar and click the AI Booster button on the AI Suite main window.

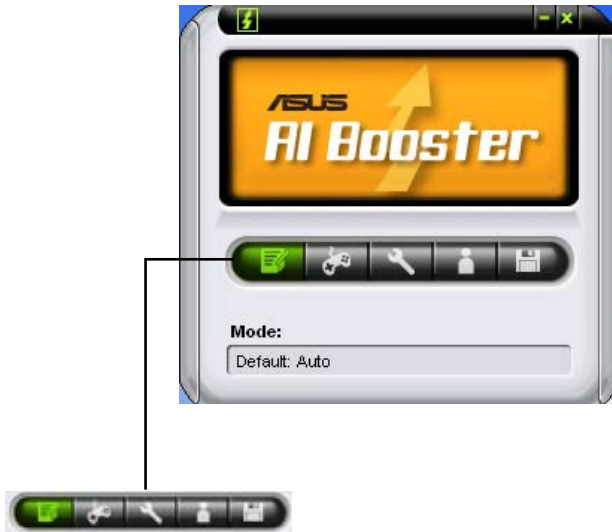

The options on the taskbar allow you to use the default settings, adjust CPU/ Memory/PCI-E frequency manually, or create and apply your personal overclocking configurations.

5.3.10 ASUS Express Gate

ASUS Express Gate is an instant-on environment that gives you quick access to the Internet. Within a few seconds of powering on your computer, you will be at the Express Gate menu where you can start the web browser, Skype, or other Express Gate softwares.

Installing ASUS Express Gate



- ASUS Express Gate supports installation on SATA HDDs in **IDE mode** only.
- ASUS Express Gate supports HDDs connected to **motherboard chipset-controlled onboard SATA ports** only. All onboard extended SATA ports and external SATA ports are NOT supported. See chapter 2 for the exact location of onboard SATA ports.
- ASUS Express Gate supports installation on USB HDDs and Flash drives, but the software performance may be slower than installed on SATA HDDs.

To install Express Gate on your computer

1. Place the support DVD to the optical drive. The **Drivers** installation tab appears if your computer has enabled Autorun feature.
2. Click the **Utilities** tab, then click **ASUS Express Gate Installer**.
3. Select the language for installation and click **OK**.
4. The InstallShield Wizard for Express Gate appears. Click **Next** to continue.

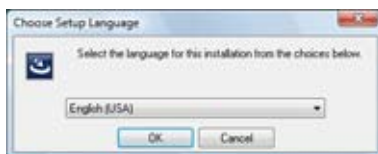

- Select the target disk volume for you to install Express Gate. If you have multiple volumes and OS installed in your hard drive, it is recommended to install Express Gate in **Volume C**. Click **Next** to continue.
- Follow the screen instructions to complete installation.



The First Screen

Express Gate's first screen appears within a few seconds after you power on the computer. From here, you can immediately start the web browser or Skype.

You can also choose to continue booting normally (e.g. to your installed OS such as Windows), enter BIOS setup, or power off.



If you don't make any selection, Express Gate will automatically exit and boot to your normal OS after a certain amount of time. The timer countdown is shown on-screen inside the "boot to OS" button. As you move the mouse or type a key, the countdown stops and the timer disappears, so you can take your time to make a selection.

The Express Gate Environment

The very first time you enter the Express Gate environment (by launching either web or Skype from the first screen), a first time wizard will guide you through basic Express Gate configurations. Basic configurations include language, date and time and screen resolution.



Once inside the Express Gate environment, click on the icons on the LaunchBar, by default at bottom of the screen, to launch or switch between softwares. You can re-arrange, re-size and move windows. Bring a window to the foreground by clicking within it or by clicking on its corresponding software icon. Re-size a window by dragging any of its four corners. Move a window by dragging its title bar.

Besides using the LaunchBar, you can also switch between softwares by pressing <Alt> +<Tab> on the keyboard. You can also right-click anywhere on the desktop to bring up a menu of softwares.

The red triangle on an software icon in the LaunchBar denotes that the software is already running. This means that you can switch to it without any delay. In the rare case where an software stops responding, right-click on its icon to force close it.

Knowing the Express Gate hot-keys

Here is a list of common-used hot-keys for Express Gate.

In the First Screen:

Key	Function
PAUSE/BREAK	Power-off
ESC	Continue to boot OS
DEL	Enter BIOS setup
F8	Enter Boot selection pop-up

In the Express Gate Environment:

Key	Function
<Alt> + <Tab>	Switch between softwares
<Ctrl> + <Alt> + 	Bring up Power-Off dialog box
<Ctrl> + <Alt> + <Print Screen>	Save screen snapshot as picture to file

Using the Configuration Panel

Use the configuration panel to change various Express Gate settings.



Click on an icon to open a particular configuration tool. The following tools are available:

- **Date and Time:** set current date and time as well as time zone.
- **Input Method:** choose your preferred input language and method.
- **Language and Keyboard:** choose your language and keyboard preferences.
- **LaunchBar Settings:** customize your LaunchBar (where it docks, whether it auto-hides, etc.)
- **Network:** Specify how your computer connects to the Internet. Enable all the network ports that you may use (LAN1, LAN2, and/or wireless [optional]). LAN1 and LAN2 refer to the two RJ-45 network ports on your computer.



- The number of the LAN ports may differ from motherboards.
- You can connect the LAN cable to either port, and Express Gate will automatically use the connected port.

Also specify whether each port uses DHCP (most common) or static IP. For PPPoE and wireless (optional), set the login credentials (user name, password, SSID, etc.) as well.

- **Environment Settings:** This function allows you to clear the Express Gate settings, as well as any personal information stored by the web browser (Bookmarks, Cookies, History, etc.). The user data will be reset to the original default configuration.

After you click **Restore System**, a confirmation dialog box will open. If you click "Yes" in the confirmation dialog box, your system will immediately restart and then re-enter Express Gate to finish clearing the settings. This is also useful in the rare case where settings might become corrupted.



The first-time Wizard will run again when you enter the Express Gate environment after clearing its settings.

- **Screen Settings:** Choose the most optimal screen resolution for your display.
- **Volume Control:** Control the volume for your speaker output, microphone input, etc.

Using the LaunchBar

The LaunchBar has several system icons that show you various system statuses and let you configure individual Express Gate settings. The LaunchBar can be configured to auto-hide, if you want more screen space for the softwares. It can also be configured to dock on any of the four sides of the screen.



Starts the **Web Browser** for quick access to the World Wide Web.



Starts the **Photo Manager** album / organizer tool.



Starts the **Chat** instant messaging tool.



Start the **Skype** software, which lets you call other people on Skype for free, as well as offering affordable, high quality voice communications to phones all over the world.



Opens **Configuration Panel**, which lets you specify network settings and other preferences.

In the rare case that one of the above softwares stops responding, you can right-click on its icon and then select **Close** to force it to close.

The smaller icons on the right side of the LaunchBar are:



Click on this icon to open the **File Manager** window, which lets you conveniently access the files on a USB drive. If a USB device is detected, the icon contains a green arrow.



ASUS Express Gate supports file uploading from SATA HDDs, ODDs and USB drive and downloading to USB drives only.



Shows network status; click to configure network.



Shows mute status; click to change volume.



Click to choose input language and method as well as keyboard shortcuts (Ctrl-Space by default).



Click to change LaunchBar options (auto-hide, docking position, etc).



Click to show the "ASUS Utility" panel.



Click to show "About Express Gate".



Click to open Express Gate Help.



Click to bring up power options window to boot to OS, restart or power down. This window is also shown when you press **Ctrl-Alt-Del** on the keyboard.

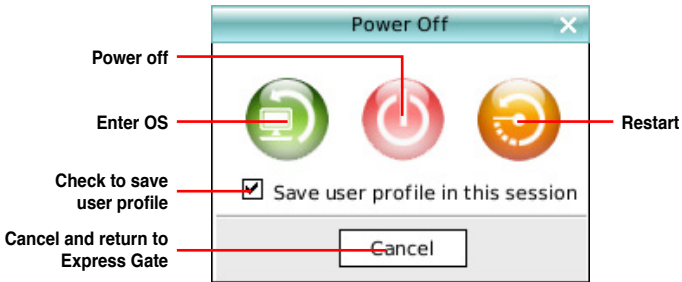

How Do I Get on to the Internet

If Internet doesn't seem to be working in the Express Gate environment, check the following:

1. Open the Configuration Panel.



Open Configuration Panel

2. Open Network.



3. Make the proper network configurations.

Each network interface is enabled immediately when you check the box next to it.



- If you use a network cable connected to a home router (which is then connected to your DSL/cable modem), enable both LAN1 and LAN2. Express Gate will automatically use whichever port (LAN1 or LAN2) is connected.



If you plug the network cable into a different port while Express Gate is running (e.g. move the cable from LAN1 to LAN2), you may need to press the "Refresh" button to detect the change.

- The most common scenario is for your computer to automatically obtain network settings (i.e. DHCP). If this is the case, you don't need to click **Setup** for any LAN port. If this is not the case, click **Setup** to configure the static IP settings manually.

- If you have wireless network, click **Setup** for the WiFi option. In the **WiFi** tab of the **Advanced Network Settings** box, enter the name of your wireless access point in the **SSID** field. If your wireless access point has security enabled, select the corresponding security algorithm from the drop-down list (e.g. WEP/AUTO) in the **Encryption Type** field, and enter the password.
Click **OK** to enable WiFi and establish the wireless connection.
- If you use a network cable connected directly to your DSL/cable modem (no router in between), click **Setup** for xDSL/cable dial-up. This method is also referred to as PPPoE. Choose whether the DSL/cable modem is connected to your computer's LAN port. Then enter the username and password for your dial-up account.
Click **OK** to enable xDSL/cable dial-up and establish the PPPoE connection.
When PPPoE is enabled, the port it uses will automatically be unchecked and grayed out.

Using the Photo Manager

Express Gate provides a easy-to-use **Photo Manager** that allows you to view pictures stored in your hard drive or external storage devices (such as USB dongles, card readers, or optical disks). You can view pictures in thumbnail view; in an enlarged view individually; in a filename/data list view; or play them in a slideshow with background music and fancy transition effects. JPEG, GIF, BMP, and PNG formats are supported. Refer to the on-line Help for detailed software operation.

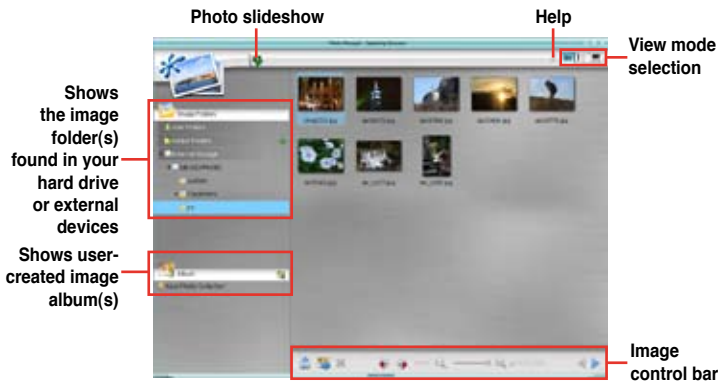

ASUS Express Gate supports HDDs connected to **motherboard chipset-controlled onboard SATA ports** only. All onboard extended SATA ports and external SATA ports are NOT supported.

Configuring Express Gate in BIOS Setup

Enter BIOS setup by pressing DEL key after powering on or by clicking on the BIOS setup icon on Express Gate's first screen. Express Gate configuration options are under the **Tools** menu. Refer to section **3.8.2 Express Gate** for details.

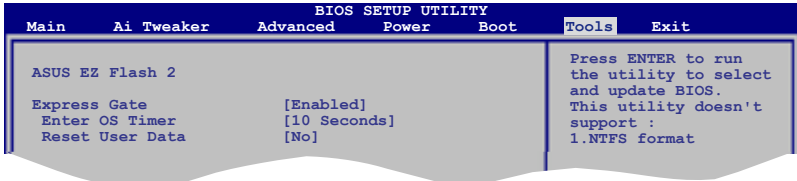

Updating Express Gate

You may update your existing Express Gate software to new versions. New versions of the Express Gate software will be released regularly, adding refinements or new applications. You can find original version of the software on the support DVD or download new versions from the ASUS support website.

To update Express Gate

1. Double-click the Express Gate setup file to start software update.
2. A software update confirmation dialog box appears. Click **Yes** to continue.
3. The InstallShield Wizard for Express Gate appears. Click **Next** to continue.
4. Follow the screen instructions to complete installation.

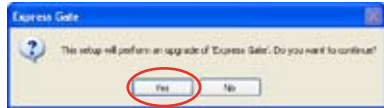

Repairing Express Gate

In case Express Gate cannot start normally, you can repair Express Gate by reinstalling the software or using the repairing utility.

To repair Express Gate

- Click **Start > All Programs > Express Gate > Express Gate Installer > Repair this software.**
- OR
- Double click the Express Gate setup file, choose **Repair**, and click **Next** to continue.



5.3.11 AMD OverDrive (AOD)

The AMD® OverDrive™ utility allows you to configure system and overclocking settings in Windows® environment. These configurations will not be saved to BIOS after the system reboots.



Some advanced options in AOD are only supported by certain AMD Black Edition CPUs (such as Phenom 9600 Black Edition, Phenom 9850 Black Edition and Phenom 9950 Black Edition). visit the AMD official website at www.amd.com for CPU support lists.

5.4 RAID configurations

The motherboard comes with the AMD SB750 chipset that allows you to configure Serial ATA hard disk drives as RAID sets. The motherboard supports the following RAID configurations: RAID 0, RAID 1, RAID 5 and RAID 10.

5.4.1 RAID definitions

RAID 0 (*Data striping*) optimizes two identical hard disk drives to read and write data in parallel, interleaved stacks. Two hard disks perform the same work as a single drive but at a sustained data transfer rate, double that of a single disk alone, thus improving data access and storage. Use of two new identical hard disk drives is required for this setup.

RAID 1 (*Data mirroring*) copies and maintains an identical image of data from one drive to a second drive. If one drive fails, the disk array management software directs all applications to the surviving drive as it contains a complete copy of the data in the other drive. This RAID configuration provides data protection and increases fault tolerance to the entire system. Use two new drives or use an existing drive and a new drive for this setup. The new drive must be of the same size or larger than the existing drive.

RAID 5 stripes both data and parity information across three or more hard disk drives. Among the advantages of RAID 5 configuration include better HDD performance, fault tolerance, and higher storage capacity. The RAID 5 configuration is best suited for transaction processing, relational database applications, enterprise resource planning, and other business systems. Use a minimum of three identical hard disk drives for this setup.

RAID 10 is data striping and data mirroring combined without parity (redundancy data) having to be calculated and written. With the RAID 0+1 configuration you get all the benefits of both RAID 0 and RAID 1 configurations. Use four new hard disk drives or use an existing drive and three new drives for this setup.



For Windows XP, if you want to boot the system from a hard disk drive included in a RAID set, first copy the RAID driver from the support DVD to a floppy disk before you install an operating system to a selected hard disk drive. Refer to section **5.5 Creating a RAID driver disk** for details.

5.4.2 Installing Serial ATA hard disks

The motherboard supports Serial ATA hard disk drives. For optimal performance, install identical drives of the same model and capacity when creating a disk array.

To install the SATA hard disks for a RAID configuration:

1. Install the SATA hard disks into the drive bays.
2. Connect the SATA signal cables.
3. Connect a SATA power cable to the power connector on each drive.

5.4.3 AMD® RAID configurations

This motherboard supports RAID 0, RAID 1, RAID 5 and RAID 10 configurations for Serial ATA hard disks drives through the AMD SB750 chip.

Setting the RAID item in BIOS

You must set the RAID item in the BIOS Setup before you can create a RAID set(s). To do this:

1. Install the internal Serial ATA hard disk drives to the SATA connectors labeled **SATA_1/2/3/4/5/6**.
2. Boot up your computer, and press during POST to enter the BIOS setup.
3. In the Main Menu, go to **Storage Configuration**, and set the **OnChip SATA Type** item to [RAID].
3. Press <F10> to save the changes and exit.



The RAID BIOS setup screens shown in this section are for reference only, and may not exactly match the items on your screen.

AMD® FastBuild™ Utility

To enter the AMD® FastBuild™ utility:

1. Boot up your computer.
2. Press <Ctrl+F> during POST to display the main menu of the utility.

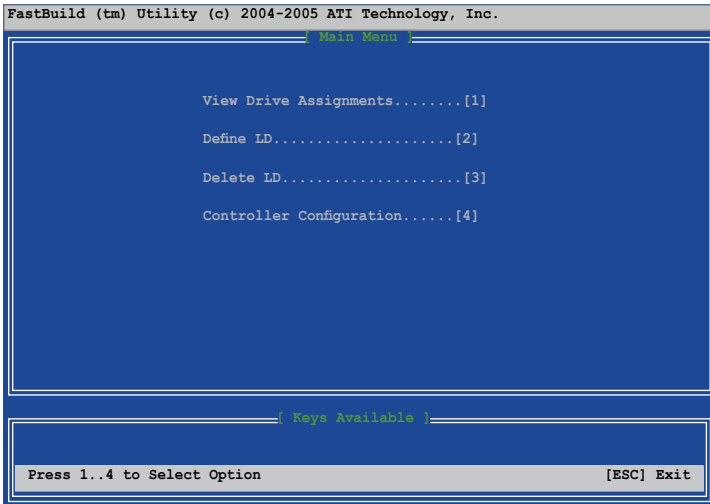

The Main Menu above allows you to select an operation to perform. The Main Menu options include:

- **View Drive Assignments:** shows the status of the hard disk drives.
 - **Define LD:** creates a RAID 0, RAID 1, RAID 5 or RAID 10 configuration.
 - **Delete LD:** deletes a selected RAID set and partition.
 - **Controller Configuration:** Shows the system resources configuration.
- Press <1>, <2>, <3>, or <4> to enter the option you need; press <ESC> to exit the utility.

Creating a RAID 0 configuration

To create a RAID 0 set:

1. In the Main Menu, press \leftarrow to enter the "Define LD" function.
2. Press \rightarrow , and the following screen appears.

```
FastBuild (tm) Utility (c) 2004-2005 ATI Technology, Inc.
| Define LD Menu |
+-----+
| LD No  RAID Mode  Total Drv |
| LD 1   RAID 0     2         |
+-----+
| Strip Block: 64 KB      Fast Init: OFF |
| Gigabyte Boundary: ON  Cache Mode: WriteThru |
+-----+
| Define LD Menu |
+-----+
| Channel:ID  Drive Model  Capacity (MB) |
| Assignment |
| 1:Mas xxxxxxxx          xxxxxx      Y |
| 2:Mas xxxxxxxx          xxxxxx      Y |
| 3:Mas xxxxxxxx          xxxxxx      N |
| 4:Mas xxxxxxxx          xxxxxx      N |
+-----+
| Keys Available |
+-----+
| [Up]Down  [Down]Down  [ESC]Exit  [Space]Change Option  [Ctrl-Y]Save |
+-----+
```

3. Highlight the **LD1** item and press \rightarrow to select **RAID 0**.
4. Move to the **Assignment** item by using the down arrow key and set **Y** to any two of the drives.
5. Press \rightarrow to save the setting. The utility prompts the following messages:

```
Press Ctrl-Y if you are sure to erase MBR! Press any other
key to ignore this option...
```

Press \rightarrow to erase MBR or press any key to continue.

```
Press Ctrl-Y to Modify Array Capacity or press any other key
to use maximum capacity...
```

Press \rightarrow to key in the desired capacity or press any key to continue.

6. The utility displays the following screen.

```
FastBuild (tm) Utility (c) 2004-2005 ATI Technology, Inc.
| Define LD Menu |
+-----+
| LD No  RAID Mode  Total Drv  Capacity(MB)  Status |
| LD 1   RAID 0     2         xxxxxx      Functional |
| LD 2   ----      ----      ----          ---- |
| LD 3   ----      ----      ----          ---- |
| LD 4   ----      ----      ----          ---- |
| LD 5   ----      ----      ----          ---- |
| LD 6   ----      ----      ----          ---- |
| LD 7   ----      ----      ----          ---- |
| LD 8   ----      ----      ----          ---- |
+-----+
| Keys Available |
+-----+
| [Up]Down  [Down]Down  [ESC]Exit  [Enter]Select |
+-----+
```

Creating a RAID 1 configuration

To create a RAID 1 set:

1. In the Main Menu, press <2> to enter the “Define LD” function.
2. Press <Enter>, and the following screen appears.

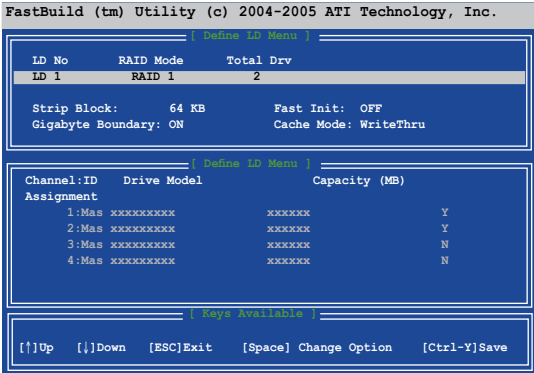

3. Highlight the **LD1** item and press <Space> to select **RAID 1**.
4. Move to the **Assignment** item by using the down arrow key and set **Y** to any two of the drives.
5. Press <Ctrl+Y> to save the setting. The utility prompts the following messages:

Press Ctrl-Y if you are sure to erase MBR! Press any other key to ignore this option...

Press <Ctrl+Y> to erase MBR or press any key to continue.

Press Ctrl-Y to Modify Array Capacity or press any other key to use maximum capacity...

Press <Ctrl+Y> to key in the desired capacity or press any key to continue.

6. The utility displays the following screen.

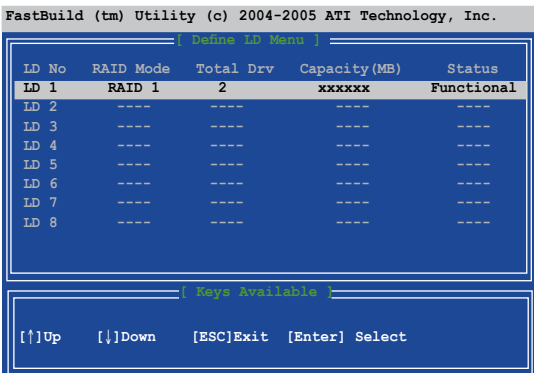

Creating a RAID 10 configuration

To create a RAID 10 set:

1. In the Main Menu, press \leftarrow to enter the "Define LD" function.
2. Press \langle Enter \rangle , and the following screen appears.

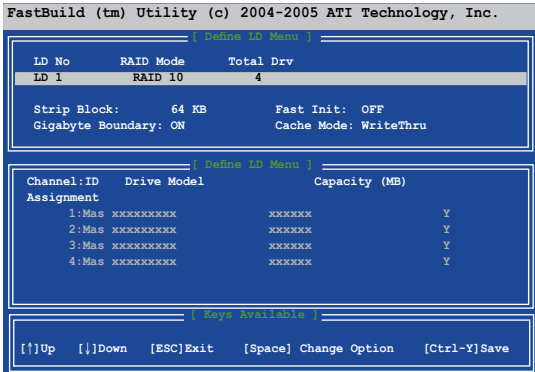

3. Highlight the **LD1** item and press \langle Space \rangle to select **RAID 10**.
4. Move to the **Assignment** item by using the down arrow key and set **Y** to any four of the drives.
5. Press \langle Ctrl+Y \rangle to save the setting. The utility prompts the following messages:

```
Press Ctrl-Y if you are sure to erase MBR! Press any other
key to ignore this option...
```

Press \langle Ctrl+Y \rangle to erase MBR or press any key to continue.

```
Press Ctrl-Y to Modify Array Capacity or press any other key
to use maximum capacity...
```

Press \langle Ctrl+Y \rangle to key in the desired capacity or press any key to continue.

6. The utility displays the following screen.

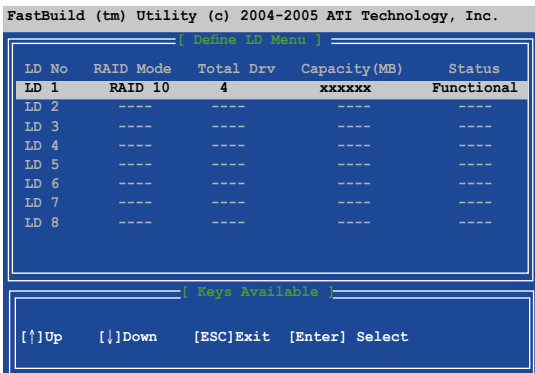

Deleting a RAID configuration

To create a RAID set:

1. In the Main Menu, press <3> to enter the "Delete LD" function.
2. Select the RAID item you want to delete and press or <Alt+D>.

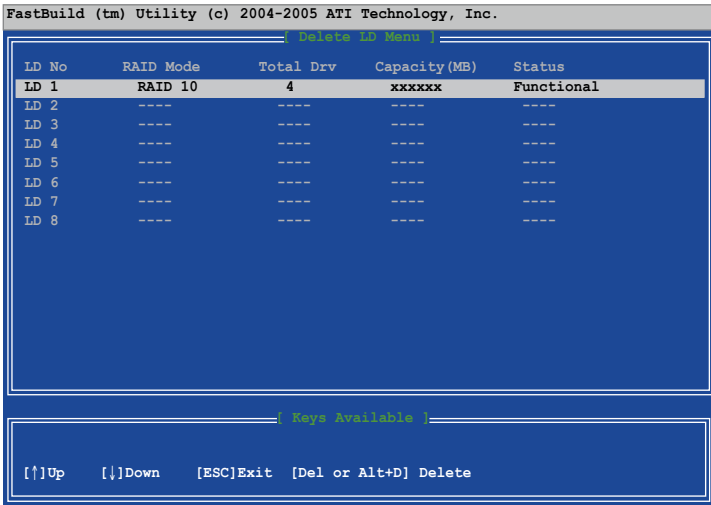

5.5 Creating a RAID driver disk

A floppy disk with the RAID driver is required when installing Windows® XP operating system on a hard disk drive that is included in a RAID set. For Windows® Vista™ operating system, use either the motherboard support CD/DVD or a USB device with the RAID driver.

5.5.1 Creating a RAID driver disk without entering the OS

To create a RAID/SATA driver disk without entering the OS:

1. Boot your computer.
2. Press during POST to enter the BIOS setup utility.
3. Set the optical drive as the primary boot device.
4. Insert the support DVD into the optical drive.
5. Save changes and exit BIOS.
6. Press any key when the system prompts "Press any key to boot from the optical drive."
7. When the menu appears, press <1> to create a RAID driver disk.
8. Insert a formatted floppy disk into the floppy drive then press <Enter>.
9. Follow succeeding screen instructions to complete the process.

5.5.2 Creating a RAID/SATA driver disk in Windows®

1. Start Windows®.
2. Place the motherboard support DVD into the optical drive.
3. Go to the Make Disk menu, then click **ATI RAID/AHCI 32/64bit WinXP/Vista Driver** to create a RAID driver disk.
4. Insert a floppy disk/USB device into the floppy disk drive/USB port.
5. Follow succeeding screen instructions to complete the process.



Write-protect the floppy disk to avoid computer virus infection.

To install the RAID driver in Windows® XP:

1. During the OS installation, the system prompts you to press the F6 key to install third-party SCSI or RAID driver.
2. Press <F6> then insert the floppy disk with RAID driver into the floppy disk drive.
3. When prompted to select the SCSI adapter to install, make sure you select **SB 750**.
4. Follow the succeeding screen instructions to complete the installation.

To install the RAID driver in Windows® Vista™:

1. Insert the floppy disk/USB device with RAID driver into the floppy disk drive/USB port.
2. During the OS installation, select **SB 750**.
3. Follow the succeeding screen instructions to complete the installation.

This chapter describes the ATI Hybrid CrossFireX™ feature and shows the graphics card installation procedures.

ATI® Hybrid CrossFireX™ technology support

Chapter summary

6

6.1	ATI® Hybrid CrossFireX™	6-1
-----	-------------------------------	-----

6.1 ATI® Hybrid CrossFire™

The motherboard supports the ATI® Hybrid CrossFire™ technology that allows you to install multi-graphics processing units (GPU) CrossFireX cards.

6.1.1 System requirements

Before using ATI Hybrid CrossFireX, ensure that your system meets the following basic requirements:

- Operating System: Windows® Vista
- Memory capacity: Minimum 1GB
- On-board graphics RAM: 256MB
- Add-on GPU: HD2400 PRO/HD2400 XT/HD3450/HD3470



- Visit the AMD official website at www.amd.com for the Hybrid CrossFireX selected GPUs.
- Currently, Hybrid CrossFireX supports only one discrete GPU which works with the integrated GPU.

6.1.2 Before you proceed

Configure the BIOS settings for the graphics card to support ATI Hybrid CrossFireX.

To set Internal Graphics

1. Press during the Power-On-Self-Test (POST) to enter the BIOS Setup utility.
2. Select **Advanced > Chipset > Internal Graphics Configuration**, set **UMA Frame Buffer Size** to [256MB], and set **Surround View** to [Enabled].

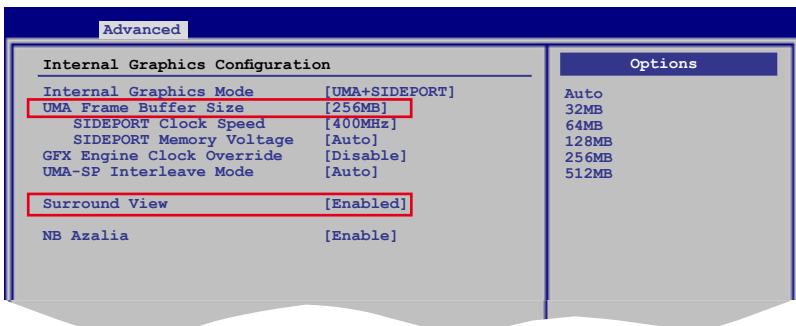

3. Press <F10> to save the changes and exit BIOS settings. Select **OK** to confirm.

6.1.3 Installing AMD Chipset Driver

To install the driver that supports Hybrid CrossFireX technology:

1. Insert the Support DVD that comes with your motherboard into the optical drive. The DVD automatically displays the Drivers menu if Autorun is enabled in your computer.



If Autorun is NOT enabled in your computer, browse the contents of the support DVD to locate the file ASSETUP.EXE from the BIN folder. Double-click the ASSETUP.EXE to run the DVD.

2. From the Drivers menu, click **AMD Chipset Driver** to install it. Follow the onscreen instructions to finish the installation.
3. Restart your computer after the installation is completed.
4. When the system restarts, wait for a few seconds for the driver to load automatically.

6.1.4 Using the ATI CATALYST® Control Center

Using an add-on graphics card

1. Install a graphics card onto your motherboard. Refer to the User Guide that comes with your graphics card for details.
2. Right-click on the Windows® desktop, then click **ATI CATALYST(R) Control Center** from the shortcut menu. The ATI CATALYST Control Center screen appears.
3. Click **Graphics Settings > CrossFire™**, then select the **Enable CrossFire™** check box. When a confirmation message pops up, click **Yes**. The screen blacks out for about one minute.
4. Click **OK**. The add-on graphics card is set to be the main monitor.



Using the onboard graphics card

1. Right-click on the Windows® desktop, and then click **ATI CATALYST(R) Control Center** from the shortcut menu. The ATI CATALYST Control Center screen appears.
2. Click **Graphics Settings > CrossFire™**, then clear the **Enable CrossFire™** check box. When a confirmation message pops up, click **Yes**. The screen blacks out for about one minute.
3. Click **OK**.



4. Right-click on the Windows® desktop, then click **Personalize** from the shortcut menu.
5. Click **Display Settings**. Select **[Default Monitor] on ATI Radeon HD 3200 Graphics**, then select the check boxes of **This is my main monitor** and **Extend the desktop onto this monitor**. Click **OK**, and then **Yes** from the confirmation window.
6. Restart the system. Right-click on the Windows® desktop, then click **ATI CATALYST(R) Control Center** from the shortcut menu. The ATI CATALYST Control Center screen appears.
7. Click **Graphics Settings > CrossFire™**, then select the **Enable CrossFire™** check box. When a confirmation pops up, click **Yes**. The screen blacks out for about one minute.
8. Click **OK**. The onboard graphics card is set to be the main monitor.



If you are using both an add-on and the on-board graphics cards at same time and want to set the onboard graphics card as your main monitor, follow the instructions on the next page.

1. Follow steps 1 to 3 on **Using the onboard graphics card.**
2. From the ATI CATALYST(R) Control Center screen, click **Display Manager > Graphics Adapter.** Select **ATI Radeon HD 3200 Graphics [Gabbs, G HW173].** Click **OK**, and then **Yes** from the confirmation window.
3. Follow steps 6 to step 8 on **Using the onboard graphics card** to complete the process of setting up the onboard graphics card as your main monitor.



Free Manuals Download Website

<http://myh66.com>

<http://usermanuals.us>

<http://www.somanuals.com>

<http://www.4manuals.cc>

<http://www.manual-lib.com>

<http://www.404manual.com>

<http://www.luxmanual.com>

<http://aubethermostatmanual.com>

Golf course search by state

<http://golfingnear.com>

Email search by domain

<http://emailbydomain.com>

Auto manuals search

<http://auto.somanuals.com>

TV manuals search

<http://tv.somanuals.com>