



# Motherboard

## M5A78L-M LX3 Series

- *M5A78L-M LX3*
- *M5A78L-M LX3 PLUS*

**Copyright © 2013 ASUSTeK COMPUTER INC. All Rights Reserved.**

No part of this manual, including the products and software described in it, may be reproduced, transmitted, transcribed, stored in a retrieval system, or translated into any language in any form or by any means, except documentation kept by the purchaser for backup purposes, without the express written permission of ASUSTeK COMPUTER INC. ("ASUS").

Product warranty or service will not be extended if: (1) the product is repaired, modified or altered, unless such repair, modification of alteration is authorized in writing by ASUS; or (2) the serial number of the product is defaced or missing.

ASUS PROVIDES THIS MANUAL "AS IS" WITHOUT WARRANTY OF ANY KIND, EITHER EXPRESS OR IMPLIED, INCLUDING BUT NOT LIMITED TO THE IMPLIED WARRANTIES OR CONDITIONS OF MERCHANTABILITY OR FITNESS FOR A PARTICULAR PURPOSE. IN NO EVENT SHALL ASUS, ITS DIRECTORS, OFFICERS, EMPLOYEES OR AGENTS BE LIABLE FOR ANY INDIRECT, SPECIAL, INCIDENTAL, OR CONSEQUENTIAL DAMAGES (INCLUDING DAMAGES FOR LOSS OF PROFITS, LOSS OF BUSINESS, LOSS OF USE OR DATA, INTERRUPTION OF BUSINESS AND THE LIKE), EVEN IF ASUS HAS BEEN ADVISED OF THE POSSIBILITY OF SUCH DAMAGES ARISING FROM ANY DEFECT OR ERROR IN THIS MANUAL OR PRODUCT.

SPECIFICATIONS AND INFORMATION CONTAINED IN THIS MANUAL ARE FURNISHED FOR INFORMATIONAL USE ONLY, AND ARE SUBJECT TO CHANGE AT ANY TIME WITHOUT NOTICE, AND SHOULD NOT BE CONSTRUED AS A COMMITMENT BY ASUS. ASUS ASSUMES NO RESPONSIBILITY OR LIABILITY FOR ANY ERRORS OR INACCURACIES THAT MAY APPEAR IN THIS MANUAL, INCLUDING THE PRODUCTS AND SOFTWARE DESCRIBED IN IT.

Products and corporate names appearing in this manual may or may not be registered trademarks or copyrights of their respective companies, and are used only for identification or explanation and to the owners' benefit, without intent to infringe.

**Offer to Provide Source Code of Certain Software**

This product contains copyrighted software that is licensed under the General Public License ("GPL"), under the Lesser General Public License Version ("LGPL") and/or other Free Open Source Software Licenses. Such software in this product is distributed without any warranty to the extent permitted by the applicable law. Copies of these licenses are included in this product.

Where the applicable license entitles you to the source code of such software and/or other additional data, you may obtain it for a period of three years after our last shipment of the product, either

(1) for free by downloading it from <http://support.asus.com/download>

or

(2) for the cost of reproduction and shipment, which is dependent on the preferred carrier and the location where you want to have it shipped to, by sending a request to:

ASUSTeK Computer Inc.  
Legal Compliance Dept.  
15 Li Te Rd.,  
Beitou, Taipei 112  
Taiwan

In your request please provide the name, model number and version, as stated in the About Box of the product for which you wish to obtain the corresponding source code and your contact details so that we can coordinate the terms and cost of shipment with you.

The source code will be distributed WITHOUT ANY WARRANTY and licensed under the same license as the corresponding binary/object code.

This offer is valid to anyone in receipt of this information.

ASUSTeK is eager to duly provide complete source code as required under various Free Open Source Software licenses. If however you encounter any problems in obtaining the full corresponding source code we would be much obliged if you give us a notification to the email address [gpl@asus.com](mailto:gpl@asus.com), stating the product and describing the problem (please DO NOT send large attachments such as source code archives, etc. to this email address).

# Contents

Safety information.....	vi
About this guide.....	vi
M5A78L-M LX3 Series specifications summary.....	viii
Package contents.....	x

## Chapter 1: Product introduction

<b>1.1 Special features.....</b>	<b>1-1</b>
1.1.1 Product highlights.....	1-1
1.1.2 ASUS Exclusive Features.....	1-2
<b>1.2 Before you proceed.....</b>	<b>1-3</b>
<b>1.3 Motherboard overview.....</b>	<b>1-4</b>
1.3.1 Placement direction.....	1-4
1.3.2 Screw holes.....	1-4
1.3.3 Motherboard layout.....	1-5
1.3.4 Layout contents.....	1-6
<b>1.4 Central Processing Unit (CPU).....</b>	<b>1-6</b>
1.4.1 CPU installation.....	1-7
1.4.2 CPU heatsink and fan assembly installation.....	1-8
<b>1.5 System memory.....</b>	<b>1-10</b>
1.5.1 Overview.....	1-10
1.5.2 Memory configurations.....	1-11
1.5.3 Installing a DIMM.....	1-15
<b>1.6 Expansion slots.....</b>	<b>1-16</b>
1.6.1 Installing an expansion card.....	1-16
1.6.2 Configuring an expansion card.....	1-16
1.6.3 PCI slot.....	1-16
1.6.4 PCI Express x1 slot.....	1-16
1.6.5 PCI Express x16 slot.....	1-16
<b>1.7 Jumpers.....</b>	<b>1-17</b>
<b>1.8 Connectors.....</b>	<b>1-19</b>
1.8.1 Rear panel ports.....	1-19
1.8.2 Internal connectors.....	1-20
<b>1.9 Software support.....</b>	<b>1-25</b>
1.9.1 Installing an operating system.....	1-25
1.9.2 Support DVD information.....	1-25

## Chapter 2: BIOS information

<b>2.1 Managing and updating your BIOS.....</b>	<b>2-1</b>
2.1.1 ASUS Update utility.....	2-1
2.1.2 ASUS EZ Flash 2 utility.....	2-2

2.1.3	ASUS CrashFree BIOS 3.....	2-3
<b>2.2</b>	<b>BIOS setup program.....</b>	<b>2-4</b>
2.2.1	BIOS menu screen.....	2-5
2.2.2	Menu bar.....	2-5
2.2.3	Navigation keys.....	2-5
2.2.4	Menu items .....	2-6
2.2.5	Submenu items .....	2-6
2.2.6	Configuration fields .....	2-6
2.2.7	Pop-up window .....	2-6
2.2.8	Scroll bar.....	2-6
2.2.9	General help .....	2-6
<b>2.3</b>	<b>Main menu.....</b>	<b>2-7</b>
2.3.1	System Time [xx:xx:xx] .....	2-7
2.3.2	System Date [Day xx/xx/xxxx].....	2-7
2.3.3	SATA3G_1~4 .....	2-7
2.3.4	SATA Configuration.....	2-8
2.3.5	System Information .....	2-8
<b>2.4</b>	<b>Advanced menu.....</b>	<b>2-9</b>
2.4.1	JumperFree Configuration .....	2-9
2.4.2	CPU Configuration .....	2-12
2.4.3	Chipset.....	2-13
2.4.4	Onboard Devices Configuration.....	2-14
2.4.5	PCI/PnP .....	2-14
2.4.6	USB Configuration .....	2-15
<b>2.5</b>	<b>Power menu .....</b>	<b>2-16</b>
2.5.1	Suspend Mode [Auto] .....	2-16
2.5.2	ACPI 2.0 Support [Enabled].....	2-16
2.5.3	ACPI APIC Support [Enabled].....	2-16
2.5.4	APM Configuration.....	2-16
2.5.5	HW Monitor Configuration.....	2-17
2.5.6	Anti Surge Support [Enabled] .....	2-18
<b>2.6</b>	<b>Boot menu.....</b>	<b>2-19</b>
2.6.1	Boot Device Priority .....	2-19
2.6.2	Boot Settings Configuration .....	2-19
2.6.3	Security .....	2-20
<b>2.7</b>	<b>Tools menu.....</b>	<b>2-22</b>
2.7.1	ASUS EZ Flash 2.....	2-22
2.7.2	ASUS O.C. Profile.....	2-22
<b>2.8</b>	<b>Exit menu .....</b>	<b>2-23</b>

## Appendices

Notices .....	A-1
ASUS contact information.....	A-3

# Safety information

## Electrical safety

- To prevent electrical shock hazard, disconnect the power cable from the electrical outlet before relocating the system.
- When adding or removing devices to or from the system, ensure that the power cables for the devices are unplugged before the signal cables are connected. If possible, disconnect all power cables from the existing system before you add a device.
- Before connecting or removing signal cables from the motherboard, ensure that all power cables are unplugged.
- Seek professional assistance before using an adapter or extension cord. These devices could interrupt the grounding circuit.
- Ensure that your power supply is set to the correct voltage in your area. If you are not sure about the voltage of the electrical outlet you are using, contact your local power company.
- If the power supply is broken, do not try to fix it by yourself. Contact a qualified service technician or your retailer.

## Operation safety

- Before installing the motherboard and adding devices on it, carefully read all the manuals that came with the package.
- Before using the product, ensure all cables are correctly connected and the power cables are not damaged. If you detect any damage, contact your dealer immediately.
- To avoid short circuits, keep paper clips, screws, and staples away from connectors, slots, sockets and circuitry.
- Avoid dust, humidity, and temperature extremes. Do not place the product in any area where it may become wet.
- Place the product on a stable surface.
- If you encounter technical problems with the product, contact a qualified service technician or your retailer.

## About this guide

This user guide contains the information you need when installing and configuring the motherboard.

## How this guide is organized

This guide contains the following parts:

- **Chapter 1: Product introduction**  
This chapter describes the features of the motherboard and the new technology it supports.
- **Chapter 2: BIOS information**  
This chapter tells how to change system settings through the BIOS Setup menus. Detailed descriptions of the BIOS parameters are also provided.

## Where to find more information

Refer to the following sources for additional information and for product and software updates.

### 1. ASUS websites

The ASUS website provides updated information on ASUS hardware and software products. Refer to the ASUS contact information.

### 2. Optional documentation

Your product package may include optional documentation, such as warranty flyers, that may have been added by your dealer. These documents are not part of the standard package.

## Conventions used in this guide

To ensure that you perform certain tasks properly, take note of the following symbols used throughout this manual.



**DANGER/WARNING:** Information to prevent injury to yourself when trying to complete a task.



**CAUTION:** Information to prevent damage to the components when trying to complete a task.



**IMPORTANT:** Instructions that you **MUST** follow to complete a task..



**NOTE:** Tips and additional information to help you complete a task.

## Typography

**Bold text**

Indicates a menu or an item to select.

*Italics*

Used to emphasize a word or a phrase.

<Key>

Keys enclosed in the less-than and greater-than sign means that you must press the enclosed key.

Example: <Enter> means that you must press the Enter or Return key.

<Key1> + <Key2> + <Key3>

If you must press two or more keys simultaneously, the key names are linked with a plus sign (+).

## M5A78L-M LX3 Series specifications summary

<b>CPU</b>	<p>AMD® Socket AM3+ for AMD® FX™ / Phenom™ II / Athlon™ II / Sempron™ 100 series processors</p> <p>AMD® Cool 'n' Quiet™ Technology</p> <p>Supports AMD® AM3/AM3+ CPU up to 95W</p> <p>* Refer to <a href="http://www.asus.com">www.asus.com</a> for the AMD® CPU support list</p>
<b>Chipset</b>	AMD® 760G(780L) / SB710
<b>Front side bus</b>	Up to 5200 MT/s HyperTransport™ 3.0 interface
<b>Memory</b>	<p>Dual-channel memory architecture</p> <p>2 x 240-pin DIMM slots support maximum 16GB unbuffered ECC and non-ECC DDR3 1866 / 1600 / 1333 / 1066MHz memory modules</p> <p>* AMD® FX™ Series CPU on this motherboard supports up to DDR3 1866MHz as its standard memory frequency.</p> <p>** Due to CPU specification, AMD® AM3 CPUs on this motherboard support up to DDR3 1333MHz.</p> <p>*** Refer to <a href="http://www.asus.com">www.asus.com</a> for the latest Memory QVL (Qualified Vendors List).</p> <p>**** Use a 64-bit Windows® OS if you want to install 4GB or more memory on the motherboard.</p>
<b>Graphics</b>	<p>Integrated ATI Radeon™ HD 3000 GPU</p> <p>Supports max. shared memory of 1GB</p> <p>Supports RGB with max. resolution of 2560 x 1440 (@75Hz)</p> <p>Supports Microsoft® DirectX 10</p> <p>Supports Hybrid CrossFireX™ (For Windows Vista or later versions)</p> <p>* Refer to <a href="http://www.amd.com">www.amd.com</a> for the discrete GPUs that support Hybrid CrossFireX™.</p>
<b>Expansion slots</b>	<p>1 x PCIe 2.0 x16 slot</p> <p>1 x PCIe 2.0 x1 slot</p> <p>1 x PCI slot</p>
<b>Storage / RAID</b>	4 x Serial ATA 3Gb/s connectors support RAID 0, 1, 10 and JBOD
<b>LAN</b>	Qualcomm Atheros Gb LAN
<b>Audio</b>	<p>Realtek® ALC887 8-channel* High Definition Audio CODEC</p> <p>* Use the chassis with HD audio module in the front panel to support 8-channel audio output.</p>
<b>USB</b>	Supports up to 8 USB 2.0/1.1 ports (4 ports at mid-board, 4 ports at the back panel)
<b>ASUS Unique Features</b>	<p>ASUS MyLogo 2</p> <p>ASUS EZ Flash 2</p> <p>ASUS EPU</p> <p>ASUS Anti-Surge</p> <p>ASUS CrashFree BIOS 3</p> <p>ASUS Fan Xpert</p> <p>ASUS Core Unlocker</p>

(continued on the next page)



## M5A78L-M LX3 Series specifications summary



<b>Special features</b>	100% All high quality conductive polymer capacitors ( <b>M5A78L-M LX3 PLUS only</b> )
<b>Back panel I/O ports</b>	<ul style="list-style-type: none"> <li>1 x PS/2 Keyboard port</li> <li>1 x PS/2 Mouse port</li> <li>1 x COM port</li> <li>1 x D-Sub port</li> <li>1 x LAN (RJ-45) port</li> <li>4 x USB 2.0 ports</li> <li>3 x Audio jacks</li> </ul>
<b>Internal I/O connectors</b>	<ul style="list-style-type: none"> <li>2 x USB 2.0 connectors support additional 4 USB 2.0 ports</li> <li>4 x SATA 3.0Gb/s connectors</li> <li>1 x CPU fan connector</li> <li>1 x Chassis fan connector</li> <li>1 x Front panel audio connector</li> <li>1 x Speaker connector</li> <li>1 x System panel connector</li> <li>1 x 24-pin EATX power connector</li> <li>1 x 4-pin ATX 12V power connector</li> </ul>
<b>BIOS</b>	16Mb Flash ROM, AMI BIOS, PnP, DMI v2.0, WiM2.0, ACPI v2.0a, SM BIOS 2.7
<b>Support DVD</b>	<ul style="list-style-type: none"> <li>Drivers</li> <li>ASUS Update</li> <li>ASUS PC Probe II</li> <li>Anti-Virus software (OEM version)</li> </ul>
<b>Form factor</b>	MicroATX form factor: 9.6 in x 7.4 in (24.4 cm x 18.8 cm)



Specifications are subject to change without notice.

## Package contents

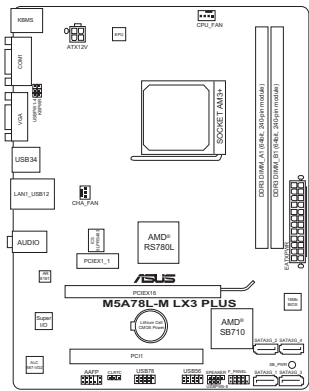
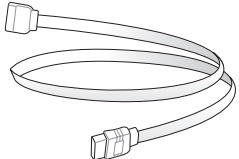
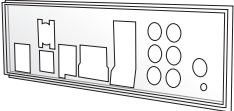
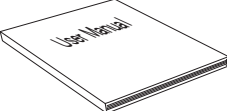
Check your motherboard package for the following items.

 <p>A detailed technical diagram of the ASUS M5A78L-M LX3 PLUS motherboard. The diagram shows various components including the CPU socket (AM3+), RAM slots, SATA ports, USB ports, LAN port, audio jacks, and various connectors. The motherboard is labeled with 'ASUS M5A78L-M LX3 PLUS' and 'AMD R5780L' and 'AMD SB710'.</p>	 <p>Two Serial ATA 3.0 Gb/s cables, one shown in a coiled position and the other straight.</p>	
<p>ASUS M5A78L-M LX3 Series motherboard</p>	<p>2 x Serial ATA 3.0 Gb/s cables</p>	
 <p>An I/O shield with various ports including USB, LAN, and audio.</p>	 <p>A user manual booklet with 'User Manual' printed on the cover.</p>	 <p>A DVD disc with a standard hub and spoke design.</p>
<p>1 x I/O Shield</p>	<p>User Guide</p>	<p>Support DVD</p>



- If any of the above items is damaged or missing, contact your retailer.
- The illustrated items above are for reference only. Actual product specifications may vary with different models.

# Product introduction

# 1

## 1.1 Special features

### 1.1.1 Product highlights

#### **AMD® FX™ / Phenom™ II / Athlon™ II / Sempron™ 100 series CPU support**

This motherboard supports AMD® Socket AM3+ multi-core processors with unique L3 cache and delivers better overclocking capabilities with less power consumption. It features dual-channel DDR3 memory support and accelerates data transfer rate up to 5200MT/s via HyperTransport™ 3.0-based system bus. This motherboard also supports AMD® CPUs in the new 32nm manufacturing process.

#### **HyperTransport™ 3.0 support**

HyperTransport™ 3.0 technology provides 2.6 times more bandwidth than HT1.0 that radically improves system efficiency for a smoother and faster computing environment.

#### **AMD® Cool 'n' Quiet Technology**

This motherboard supports the AMD® Cool 'n' Quiet technology which monitors system operation and automatically adjusts CPU voltage and frequency for a cool and quiet operating environment.

#### **Dual-Channel DDR3 1866 support**

This motherboard supports DDR3 memory that features data transfer rates of 1866 /1600 /1333/1066 MHz to meet the higher bandwidth requirements of the latest operating system, 3D graphics, multimedia, and Internet applications.

#### **Hybrid CrossFireX™ support**

ATI Hybrid CrossFireX™ technology greatly boosts graphics performance with an onboard GPU and a discrete GPU.

\* **Hybrid CrossFireX™ is supported by Windows® Vista or later versions only.**

\*\* **Refer to [www.amd.com](http://www.amd.com) for the discrete GPUs that support Hybrid CrossFireX™.**

#### **Gigabit LAN solution**

The onboard LAN controller is a highly integrated Gb LAN controller. It is enhanced with an ACPI management function to provide efficient power management for advanced operating systems.

#### **Serial ATA 3Gb/s technology and RAID support**

This motherboard supports hard drives based on the Serial ATA (SATA) 3Gb/s storage specification, delivering enhanced scalability and doubling the bus bandwidth for high-speed data retrieval and save. It also supports RAID 0, RAID 1, and RAID 0+1 configurations for Serial ATA hard drives.

## **100% All High-quality Conductive Polymer Capacitors (M5A78L-M LX3 PLUS only)**

This motherboard uses all high-quality conductive polymer capacitors for durability, improved lifespan, and enhanced thermal capacity.

### **1.1.2 ASUS Exclusive Features**

#### **Core Unlocker**

ASUS Core Unlocker simplifies the activation of a latent AMD® CPU-with just pressing a key. Enjoy an instant performance boost by simply unlocking the extra cores, without performing complicated BIOS changes.

#### **ASUS Anti-Surge Protection**

This special design protects expensive devices and the motherboard from damage caused by power surges from switching power supply unit (PSU).

#### **ASUS EPU**

ASUS EPU is a unique power saving technology that detects the current system loadings and adjusts the power consumption in real time.

#### **ASUS EZ Flash 2**

ASUS EZ Flash 2 is a user-friendly utility that allows you to update the BIOS without using a bootable floppy disk or an OS-based utility.

#### **ASUS MyLogo2™**

This feature allows you to convert your favorite photo into a 256-color boot logo for a more colorful and vivid image on your screen.

#### **ASUS CrashFree BIOS 3**

ASUS CrashFree BIOS 3 is an auto-recovery tool that allows you to restore a corrupted BIOS file using the bundled support DVD or a USB flash disk that contains the BIOS file.

#### **ErP ready**

The motherboard is European Union's Energy-related Products (ErP) ready, and ErP requires products to meet certain energy efficiency requirements in regards to energy consumptions. This is in line with ASUS vision of creating environment-friendly and energy-efficient products through product design and innovation to reduce carbon footprint of the product and thus mitigate environmental impacts.

## 1.2 Before you proceed

Take note of the following precautions before you install motherboard components or change any motherboard settings.



- Unplug the power cord from the wall socket before touching any component.
- Before handling components, use a grounded wrist strap or touch a safely grounded object or a metal object, such as the power supply case, to avoid damaging them due to static electricity.
- Hold components by the edges to avoid touching the ICs on them.
- Whenever you uninstall any component, place it on a grounded antistatic pad or in the bag that came with the component.
- Before you install or remove any component, switch off the ATX power supply and detach its power cord. Failure to do so may cause severe damage to the motherboard, peripherals, or components.

### Standby Power LED

The motherboard comes with a standby power LED that lights up to indicate that the system is ON, in sleep mode, or in soft-off mode. This is a reminder that you should shut down the system and unplug the power cable before removing or plugging in any motherboard component. The illustration below shows the location of the onboard LED.

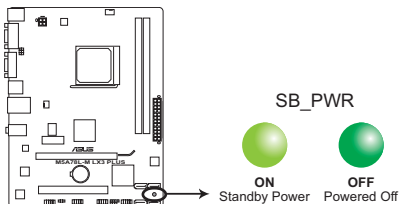

**M5A78L-M LX3 PLUS Onboard LED**

## 1.3 Motherboard overview

### 1.3.1 Placement direction

When installing the motherboard, ensure that you place it into the chassis in the correct orientation. The edge with external ports goes to the rear part of the chassis as indicated in the image below.

### 1.3.2 Screw holes

Place six screws into the holes indicated by circles to secure the motherboard to the chassis.



DO NOT overtighten the screws! Doing so can damage the motherboard.

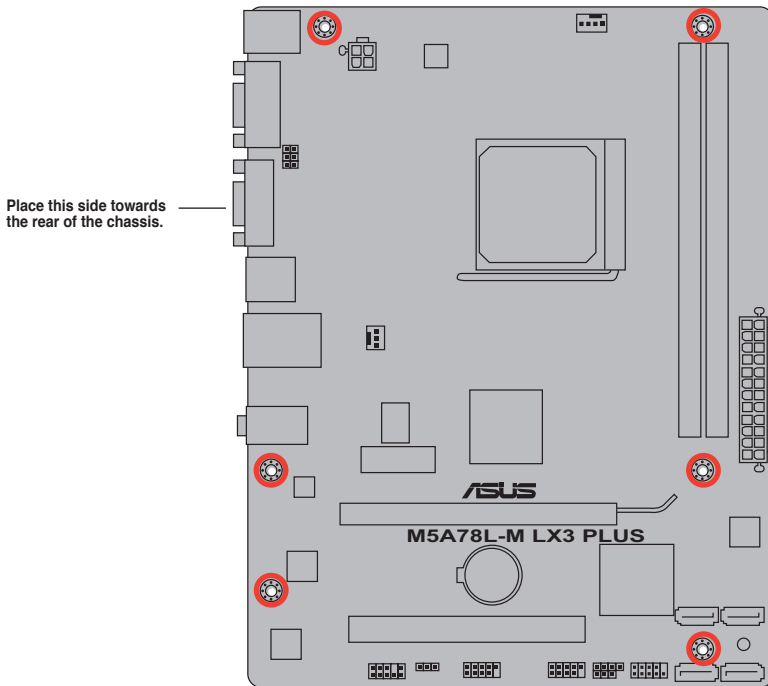

### 1.3.3 Motherboard layout



M5A78L-M LX3 Series motherboards include M5A78L-M LX3 PLUS and M5A78L-M LX3 models. The package contents vary from models. The layout illustrations in this user guide are for M5A78L-M LX3 PLUS only.

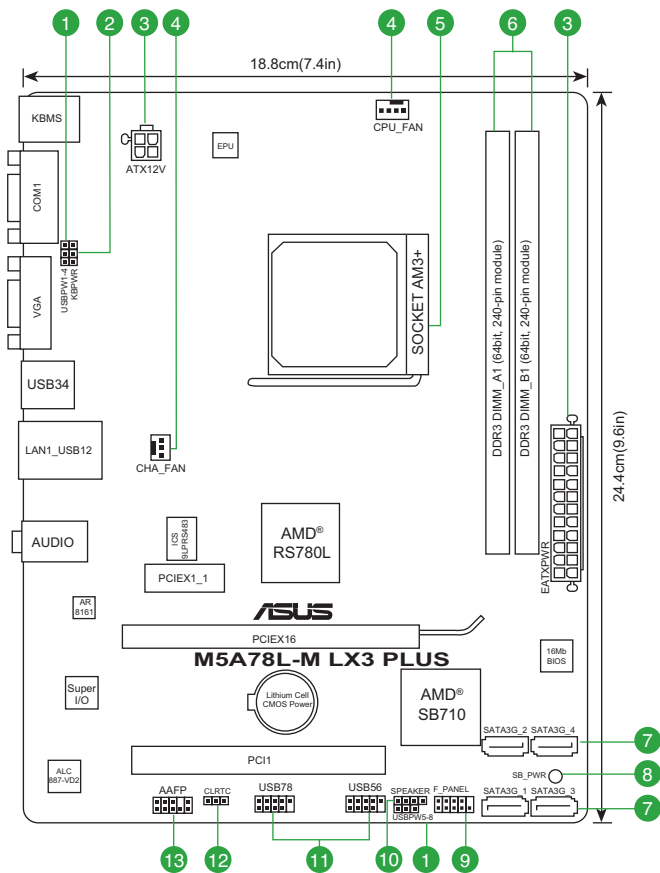

## 1.3.4 Layout contents

Connectors/Jumpers/Slots/LED	Page
1. USB device wake-up (3-pin USBPW 1-4, USBPW 5-8)	1-18
2. Keyboard power (3-pin KBPWR)	1-18
3. ATX power connectors (24-pin EATXPWR, 4-pin ATX12V)	1-21
4. CPU and chassis fan connectors (4-pin CPU_FAN and 3-pin CHA_FAN)	1-24
5. AMD CPU socket	1-6
6. DDR3 DIMM slots	1-10
7. SATA 3.0Gb/s connectors (7-pin SATA3G_1~4)	1-22
8. Standby power LED (SB_PWR)	1-3
9. System panel connector (10-1 pin F_PANEL)	1-23
10. Speaker connector (4-pin SPEAKER)	1-23
11. USB 2.0 connectors (10-1 pin USB56, USB78)	1-24
12. Clear RTC RAM (3-pin CLRTC)	1-17
13. Front panel audio connector (10-1 pin AAFP)	1-20

## 1.4 Central Processing Unit (CPU)

This motherboard comes with an AM3+ socket designed for FX™ / Phenom™ II / Athlon™ II / Sempron™ 100 series processors.



The AM3+ socket has a different pinout from the AM2+/AM2 socket. Ensure that you use a CPU designed for the AM3+ socket. The CPU fits in only one correct orientation. **DO NOT** force the CPU into the socket to prevent bending the pins and damaging the CPU!

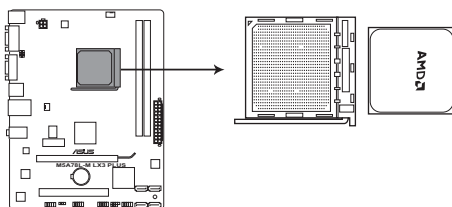

**M5A78L-M LX3 PLUS CPU socket AM3+**



### 1.4.1 CPU installation

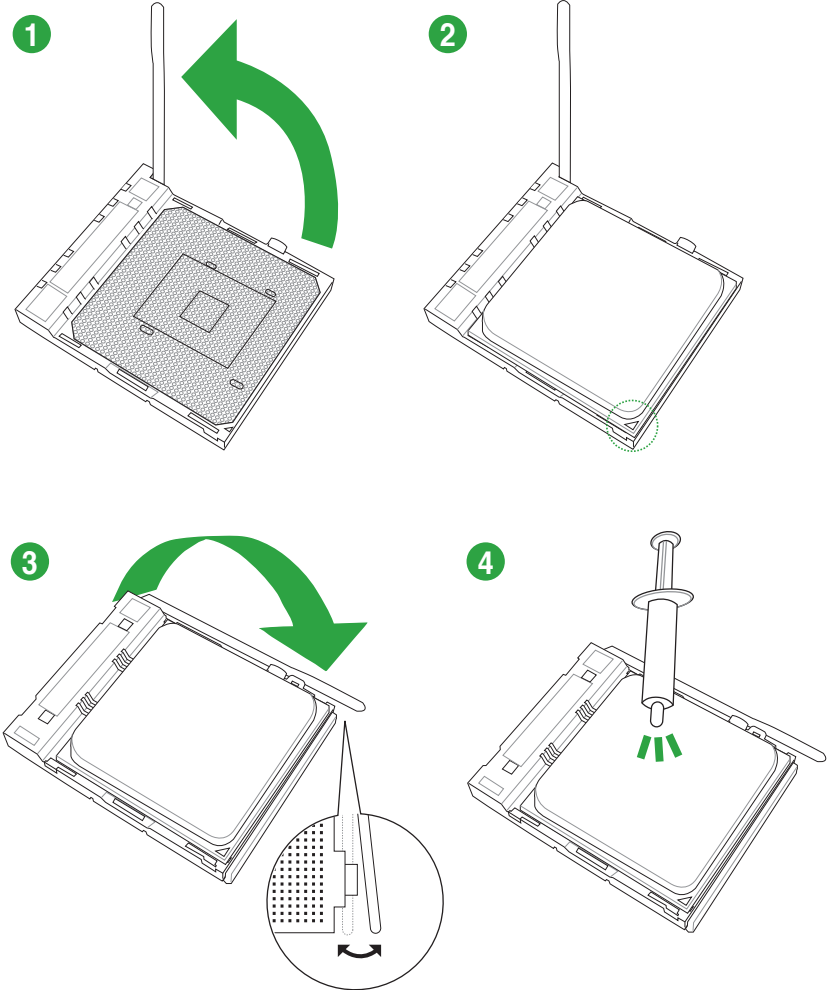

## 1.4.2 CPU heatsink and fan assembly installation

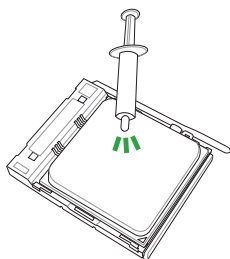

Apply the Thermal Interface Material to the CPU heatsink and CPU before you install the heatsink and fan if necessary.

To install the CPU heatsink and fan assembly

1

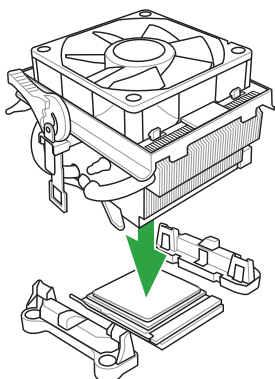

2

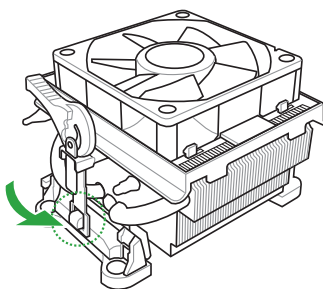

3

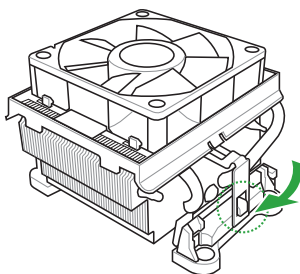

4

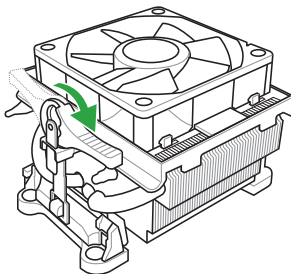

5

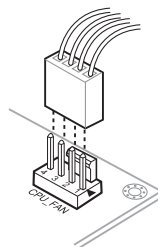

## To uninstall the CPU heatsink and fan assembly

1

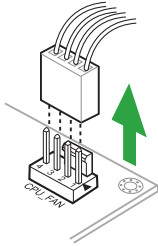

2

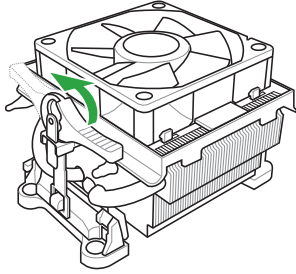

3

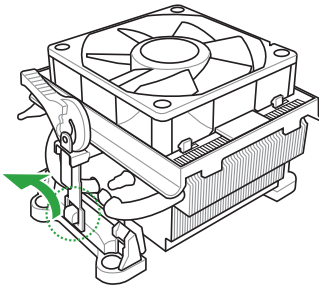

4

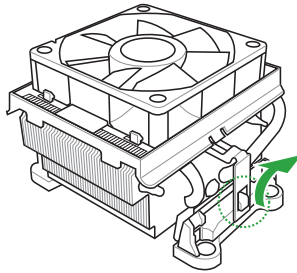

5

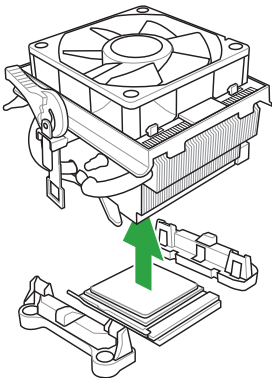

# 1.5 System memory

## 1.5.1 Overview

This motherboard comes with two Double Data Rate 3 (DDR3) Dual Inline Memory Modules (DIMM) sockets.

A DDR3 module has the same physical dimensions as a DDR2 DIMM but is notched differently to prevent installation on a DDR2 DIMM socket. DDR3 modules are developed for better performance with less power consumption.

The figure illustrates the location of the DDR3 DIMM sockets:

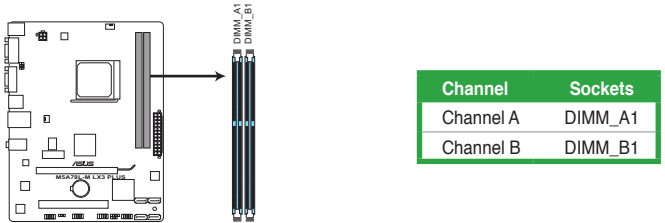

**M5A78L-M LX3 PLUS 240-pin DDR3 DIMM sockets**

## 1.5.2 Memory configurations

You may install 1GB, 2GB, 4GB, and 8GB unbuffered non-ECC DDR3 DIMMs into the DIMM sockets.



- You may install varying memory sizes in Channel A and Channel B. The system maps the total size of the lower-sized channel for the dual-channel configuration. Any excess memory from the higher-sized channel is then mapped for single-channel operation.
- Always install DIMMs with the same CAS latency. For optimal compatibility, we recommend that you install memory modules of the same version or date code (D/C) from the same vendor. Check with the retailer to get the correct memory modules.
- Due to the memory address limitation on 32-bit Windows® OS, when you install 4GB or more memory on the motherboard, the actual usable memory for the OS can be about 3GB or less. For effective use of memory, we recommend that you do any of the following:
  - Install a maximum of 3GB system memory if you are using a 32-bit Windows® OS.
  - Use a 64-bit Windows® OS if you want to install 4GB or more memory on the motherboard.
- This motherboard does not support DIMMs made up of 512Mb (64MB) chips or less.

## M5A78L-M LX3 Series Motherboard Qualified Vendors Lists (QVL)

### DDR3-1866MHz capability

Vendors	Part No.	Size	SS/ DS	Chip Brand	Chip NO.	Timing	Voltage	DIMM socket support (Optional)	
								1 DIMM*	2 DIMMs*
KINGSTON	KHX1866C9D3T1K3/ 6GX(XMP)	6GB(3 x 2GB)	DS	-	-	-	1.65V	•	•
OCZ	OCZ3G1866LV4GK	4GB(2 x 2GB)	DS	-	-	10-10-10-27	1.65V	•	•
CORSAIR	CMT4GX3M2A1866C9(XMP)	4GB(2 x 2GB)	DS	-	-	9-9-9-24	1.65V	•	•
CORSAIR	CMT6GX3MA1866C9(XMP)	6GB(3 x 2GB)	DS	-	-	9-9-9-24	1.65V	•	•
CORSAIR	CMZ8GX3M2A1866C9(XMP)	8GB(2 x 4GB)	DS	-	-	9-10-9-27	1.50V	•	•
G.SKILL	F3-14900CL9Q-8GBXL(XMP)	8GB(2GBx4)	DS	-	-	9-9-9-24	1.6V	•	•

## DDR3-1600MHz capability

Vendors	Part No.	Size	SS/DS	Chip Brand	Chip NO.	Timing	Voltage	DIMM socket support (Optional)	
								1 DIMM*	2 DIMMs*
A-Data	AD31600E001GM(O)U3K	3GB(3 x 1GB)	SS	-	-	8-8-8-24	1.65V-1.85V	*	*
A-Data	AX3U1600XC4G79-2X(XMP)	8GB(2 x 4GB)	DS	-	-	7-9-7-21	1.55V-1.75V	*	*
A-Data	AX3U1600GC4G9-2G(XMP)	8GB(2 x 4GB)	DS	-	-	9-9-9-24	1.55V-1.75V	*	*
CORSAIR	CMX4GX3M2A1600C9(XMP)	4GB(2 x 2GB)	DS	-	-	9-9-9-24	1.65V	*	*
CORSAIR	TR3X6G1600C8D G(XMP)	6GB(3 x 2GB)	DS	-	-	8-8-8-24	1.65V	*	*
CORSAIR	TR3X6G1600C9 G(XMP)	6GB(3 x 2GB)	DS	-	-	9-9-9-24	1.65V	*	*
CORSAIR	CMP8GX3M2A1600C9(XMP)	8GB(2 x 4GB)	DS	-	-	9-9-9-24	1.65V	*	*
CORSAIR	CMX8GX3M4A1600C9(XMP)	8GB(4 x 2GB)	DS	-	-	9-9-9-24	1.65V	*	*
G.SKILL	F3-12800CL9D-2GBNQ(XMP)	2GB(2 x 1GB)	SS	-	-	9-9-9-24	1.5V	*	*
G.SKILL	F3-12800CL9D-4GBECO(XMP)	4GB(2 x 2GB)	DS	-	-	9-9-9-24	XMP 1.35V	*	*
G.SKILL	F3-12800CL7D-4GBRM(XMP)	4GB(2 x 2GB)	DS	-	-	7-8-7-24	1.6V	*	*
G.SKILL	F3-12800CL8D-4GBRM(XMP)	4GB(2 x 2GB)	DS	-	-	8-8-8-24	1.60V	*	*
G.SKILL	F3-12800CL7D-8GBRH(XMP)	8GB(2 x 4GB)	DS	-	-	7-8-7-24	1.6V	*	*
G.SKILL	F3-12800CL9D-8GBRL(XMP)	8GB(2 x 4GB)	DS	-	-	9-9-9-24	1.5V	*	*
KINGMAX	FLGE85F-B8KJ9A FEIS(XMP)	2GB	DS	-	-	-	-	*	*
KINGSTON	KHX1600C9AD3/2G	2GB	DS	-	-	-	1.65V	*	*
KINGSTON	KHX1600C7D3K2/4GX(XMP)	4GB ( 2x 2GB )	DS	-	-	-	1.65V	*	*
KINGSTON	KHX1600C9D3P1K2/4G	4GB(2 x 2GB)	SS	-	-	-	1.5V	*	*
OCZ	OCZ3G1600LV4GK	4GB(2 x 2GB)	DS	-	-	8-8-8-24	1.65V	*	*
Super Talent	WA160UX6G9	6GB(3 x 2GB)	DS	-	-	9	-	*	*
GEIL	GET316GB1600C9QC(XMP)	16G(4x 4GB)	DS	-	-	9-9-9-28	1.6V	*	*
Crucial	BL25664BN1608.16FF(XMP)	6GB(3 x 2GB)	DS	-	-	-	-	*	*
Transcend	JM1600KLN-8GK	8GB(4GBx2)	DS	Transcend	TK483PCW3	-	-	*	*

## DDR3-1333 MHz capability

Vendors	Part No.	Size	SS/DS	Chip Brand	Chip NO.	Timing	Voltage	DIMM socket support (Optional)	
								1 DIMM*	2 DIMMs*
A-Data	AD31333001GOU	1GB	SS	A-Data	AD30908C8D-151C E0906	-	-	*	*
A-Data	AD6311B0823EV	2GB	SS	A-Data	3CCA-1509A	-	-	*	*
A-Data	AD31333G001GOU	3GB(3 x 1GB)	SS	-	-	8-8-8-24	1.65-1.85V	*	*
A-Data	AXDU1333GC2G9-2G(XMP)	4GB(2 x 2GB)	SS	-	-	9-9-9-24	1.25V-1.35V(low voltage)	*	*
A-Data	AD31333G002GMU	2GB	DS	-	-	8-8-8-24	1.65-1.85V	*	*
A-Data	AD6311C1624EV	4GB	DS	A-Data	3CCA-1509A	-	-	*	*
Apacer	78.A1GC6.9L1	2GB	DS	Apacer	AM5D5808DEWSBG	-	-	*	*
Apacer	78.A1GC6.9L1	2GB	DS	Apacer	AM5D5808FEQSBG	9	-	*	*
Apacer	78.B1GDE.9L10C	4GB	DS	Apacer	AM5D5908CEHSBG	-	-	*	*
CORSAIR	CM3X1024-1333C9	1GB	SS	-	-	9-9-9-24	1.60V	*	*
CORSAIR	TR3X3G1333C9 G	3GB(3 x 1GB)	SS	-	-	9-9-9-24	1.50V	*	*
CORSAIR	TR3X6G1333C9 G	6GB(3x 2GB)	SS	-	-	9-9-9-24	1.50V	*	*
CORSAIR	CMD24GX3M6A1333C9(XMP)	24GB(6x4GB)	DS	-	-	9-9-9-24	1.60V	*	*
CORSAIR	TW3X4G1333C9D G	4GB(2 x 2GB)	DS	-	-	9-9-9-24	1.50V	*	*
CORSAIR	CMD8GX3M4A1333C7	8GB(4 x 2GB)	DS	-	-	7-7-7-20	1.60V	*	*
Crucial	CT25664BA1339.18FF	2GB	DS	Micron	9KF27D9KPT	9	-	*	*
Crucial	BL25664BN1337.16FF(XMP)	6GB(3 x 2GB)	DS	-	-	7-7-7-24	1.65V	*	*
Crucial	CT25672BA1339.18FF	2GB	DS	Micron	91F22D9KPT(ECC)	9	-	*	*
ELPIDA	EBJ10UE8EDF0-DJ-F	1GB	SS	ELPIDA	J1108EDSE-DJ-F	-	1.35V(low voltage)	*	*
ELPIDA	EBJ21UE8EDF0-DJ-F	2GB	DS	ELPIDA	J1108EDSE-DJ-F	-	1.35V(low voltage)	*	*
G.SKILL	F3-10600CL8D-2GBHK(XMP)	1GB	SS	G.SKILL	-	-	-	*	*
G.SKILL	F3-10600CL9D-2GBNQ	2GB(2 x 1GB)	SS	-	-	9-9-9-24	1.5V	*	*

continued on the next page

## DDR3-1333 MHz capability

Vendors	Part No.	Size	SS/DS	Chip Brand	Chip NO.	Timing	Voltage	DIMM socket support (Optional)
								1 DIMM* 2 DIMMs*
G.SKILL	F3-10666CL7T-3GBPK (XMP)	3GB(3 x 1GB)	SS	-	-	7-7-7-18	1.5~1.6V	• •
G.SKILL	F3-10666CL8D-4GBECO(XMP)	4GB(2 x 2GB)	DS	-	-	8-8-8-8-24	XMP 1.35V	• •
G.SKILL	F3-10666CL7T-6GBPK (XMP)	6GB(3 x 2GB)	DS	-	-	7-7-7-18	1.5~1.6V	• •
G.SKILL	F3-10666CL7D-8GBRH (XMP)	8GB(2 x 4GB)	DS	-	-	7-7-7-21	1.5V	• •
GEIL	GET316GB1333C9QC	16GB(4x 4GB)	DS	-	-	9-9-9-24	1.5V	• •
GEIL	GV32GB1333C9DC	2GB(2 x 1GB)	DS	-	-	9-9-9-24	1.5V	• •
GEIL	GG34GB1333C9DC	4GB(2 x 2GB)	DS	GEIL	GL1L128M88BA12N	9-9-9-24	1.3V(low voltage)	• •
GEIL	GV34GB1333C9DC	4GB(2 x 2GB)	DS	-	-	9-9-9-24	1.5V	• •
GEIL	GVP34GB1333C7DC	4GB(2 x 2GB)	DS	-	-	7-7-7-24	1.5V	• •
Hynix	HMT112U6TFR8A-H9	1GB	SS	Hynix	H5TC1G83TFRH9A	-	1.35V(low voltage)	• •
Hynix	HMT325U6BFR8C-H9	2GB	SS	Hynix	H5T02G83BFRH9C	-	-	• •
Hynix	HMT125U6TFR8A-H9	2GB	DS	Hynix	H5TC1G83TFRH9A	-	1.35V(low voltage)	• •
Hynix	HMT351U6BFR8C-H9	4GB	DS	Hynix	H5T02G83BFRH9C	-	-	• •
KINGMAX	FLFE85F-C8K9 CAES	2GB	SS	KINGMAX	KFC8FNMXF-DXX-15A	-	-	• •
KINGMAX	FLFE85F-C8K9 NAES	2GB	SS	KINGMAX	KFC8FNLXF-DXX-15A	-	-	• •
KINGMAX	FLFE85F-C8KM9 NAES	2GB	SS	KINGMAX	KFC8FNMXF-BXX-15A	-	-	• •
KINGMAX	FLFE85F-B8KL9 NEES	2GB	DS	KINGMAX	KK8BFNWBFGNX-26A	-	-	• •
KINGMAX	FLFF65F-C8K9 NEES	4GB	DS	KINGMAX	KFC8FNLXF-DXX-15A	-	-	• •
KINGMAX	FLFF65F-C8KM9 NEES	4GB	DS	KINGMAX	KFC8FNMXF-BXX-15A	-	-	• •
KINGSTON	KVR1333D3N9/2G (low profile)	2GB	SS	Hynix	H5TQ2G83AFRH9C	9	-	• •
KINGSTON	KVR1333D3S98N9/2G	2GB	SS	Micron	IID77 D9L GK	-	1.5V	• •
KINGSTON	KVR1333D3N9/2G (low profile)	2GB	DS	ELPIDA	J1108BFBG-DJ-F	9	1.5V	• •
KINGSTON	KVR1333D3N9/2G	2GB	DS	KTC	D1288JPNDDL9U	9	1.5V	• •
KINGSTON	KVR1333D3N9/2G	2GB	DS	ELPIDA	J1108BDSE-DJ-F	9	1.5V	• •
KINGSTON	KVR1333D3N9/2G-SP (low profile)	2GB	DS	KTC	D1288JEMFNGD9U	-	1.5V	• •
KINGSTON	KVR1333D3N9/2G-SP (low profile)	2GB	DS	KINGSTON	D1288JPSFPGD9U	-	1.5V	• •
KINGSTON	KHX1333C7D3K2/4GX (XMP)	4GB(2 x 2GB)	DS	-	-	7	1.65V	• •
KINGSTON	KHX1333C9D3UK2/4GX (XMP)	4GB(2 x 2GB)	DS	-	-	9	XMP 1.25V	• •
KINGSTON	KVR1333D3N9/4G (low profile)	4GB	DS	ELPIDA	J2108BCSE-DJ-F	9	1.5V	• •
KINGSTON	KVR1333D3N9/4G	4GB	DS	KTC	D2568JENCNGD9U	-	1.5V	• •
KINGSTON	KVR1333D3N9/4G	4GB	DS	Hynix	H5TQ2G83AFR	-	1.5V	• •
KINGSTON	KVR1333D3N9/4G-SP (low profile)	4GB	DS	KINGSTON	D2568JENCPCD9U	-	1.5V	• •
Micron	MT4JTF12864AZ-1G4D1	1GB	SS	Micron	QJD12D9L GQ	-	-	• •
Micron	MT8JTF25664AZ-1G4D1	2GB	SS	Micron	QJD12D9L GK	-	-	• •
Micron	MT16JTF25664AZ-1G4F1	2GB	DS	Micron	9KF27D9KPT	9	-	• •
Micron	MT16JTF51264AZ-1G4D1	4GB	DS	Micron	OLD22D9L GK	-	-	• •
Micron	MT8JTF25664AZ-1G4M1	2GB	SS	MICRON	IJM22 D9PFJ	-	-	• •
OCZ	OCZ3G1333LV6GK	6GB(3 x 2GB)	DS	-	-	9-9-9-20	1.65V	• •
OCZ	OCZ3P1333LV6GK	6GB(3 x 2GB)	DS	-	-	7-7-7-20	1.65V	• •
OCZ	OCZ3X1333LV6GK(XMP)	6GB(3 x 2GB)	DS	-	-	8-8-8-20	1.60V	• •
PSC	AL7F8G73F-DJ2	1GB	SS	PSC	A3P1GF3FGF	-	-	• •
PSC	AL8F8G73F-DJ2	2GB	DS	PSC	A3P1GF3FGF	-	-	• •
SAMSUNG	M378B2873FHS-CH9	1GB	SS	SAMSUNG	K4B1G0846F	-	-	• •
SAMSUNG	M378B5673FH0-CH9	2GB	DS	SAMSUNG	K4B1G0846F	-	-	• •
SAMSUNG	M378B5273CH0-CH9	4GB	DS	SAMSUNG	K4B2G0846C	-	-	• •
SAMSUNG	M378B1G73AH0-CH9	8GB	DS	SAMSUNG	K4B4G0846A-HCH9	-	-	• •
Super Talent	W1333UA1GH	1GB	SS	Hynix	H5TQ1G83TFR	9	-	• •
Super Talent	W1333X2G8(XMP)	1GB	SS	-	-	8	-	• •
Super Talent	W1333UB2GS	2GB	DS	SAMSUNG	K4B1G0846F	9	-	• •
Super Talent	W1333UB4GS	4GB	DS	SAMSUNG	K4B2G0846C	-	-	• •
Super Talent	W1333UX6GM	6GB(3x 2GB)	DS	Micron	0BF27D9KPT	9-9-9-24	1.5V	• •
Transcend	JM1333KLN-2G	2GB	SS	Micron	OYD77D9L GK	-	-	• •
Transcend	JM1333KLN-2G	2GB	SS	Hynix	H5TQ2G83BZRH9C	-	-	• •
Transcend	JM1333KLU-2G	2GB	DS	Transcend	TK243PDF3	-	-	• •
NANYA	NT4GC648BH8G0NF-CG	4GB	DS	NANYA	NT5CB256M8GN-CG	-	-	• •

## DDR3-1066 MHz capability

Vendors	Part No.	Size	SS/DS	Chip Brand	Chip NO.	Timing	Voltage	DIMM socket support (Optional)	
								1 DIMM*	2 DIMMs*
Crucial	CT12864BA1067.8FF	1GB	SS	Micron	9GF22D9KPT	7	-	•	•
Crucial	CT25664BA1067.16FF	2GB	DS	Micron	9HF22D9KPT	7	-	•	•
ELPIDA	EBJ10UE8EDF0-AE-F	1GB	SS	ELPIDA	J1108EDSE-DJ-F	-	1.35V(low voltage)	•	•
ELPIDA	EBJ21UE8EDF0-AE-F	2GB	DS	ELPIDA	J1108EDSE-DJ-F	-	1.35V(low voltage)	•	•
KINGSTON	KVR1066D3N7/1G(low profile)	1GB	SS	ELPIDA	J1108BFSE-DJ-F	7	1.5V	•	•
KINGSTON	KVR1066D3N7/2G	2GB	DS	ELPIDA	J1108BDSE-DJ-F	7	1.5V	•	•
KINGSTON	KVR1066D3N7/4G	4GB	DS	Hynix	H5TQ2G83AFR	7	1.5V	•	•
Micron	MT8JTF12864AZ-1G1F1	1GB	SS	Micron	9GF22D9KPT	7	-	•	•
Micron	MT16JTF25664AZ-1G1F1	2GB	DS	Micron	9HF22D9KPT	7	-	•	•



- AMD® FX™ Series CPU on this motherboard supports up to DDR3 1866MHz as its standard memory frequency.
- Due to CPU spec., AMD® AM3 CPUs on this motherboard support up to DDR3 1333MHz.



**SS: Single-sided / DS: Double-sided**

**DIMM support:**

- **1 DIMM\***: Supports one module inserted into any slot as single-channel memory configuration.
- **2 DIMMs\***: Supports one pair of modules inserted into either slot or the blue slots as one pair of dual-channel memory configuration.



Visit the ASUS website at [www.asus.com](http://www.asus.com) for the latest QVL.



### 1.5.3 Installing a DIMM

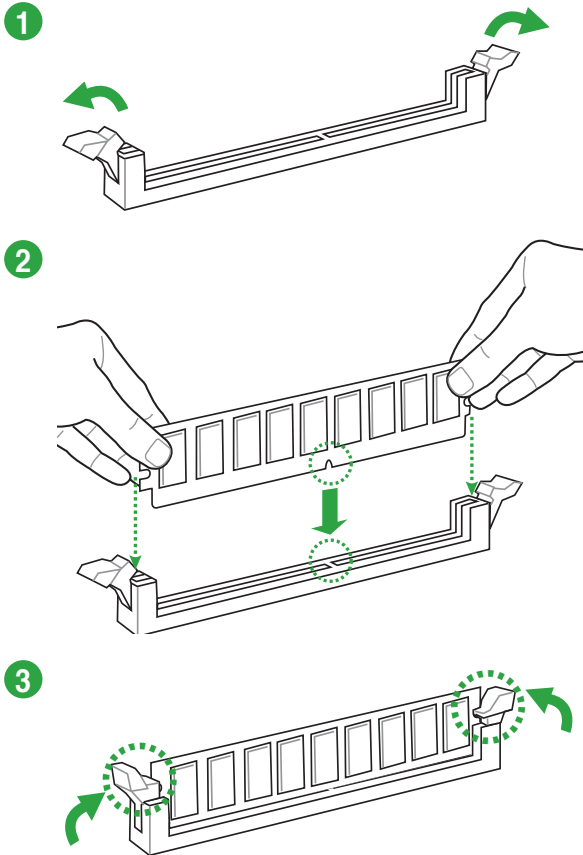

#### To remove a DIMM

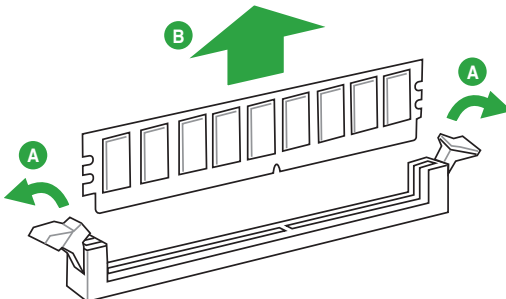

## 1.6 Expansion slots

In the future, you may need to install expansion cards. The following sub-sections describe the slots and the expansion cards that they support.



---

Unplug the power cord before adding or removing expansion cards. Failure to do so may cause you physical injury and damage motherboard components.

---

### 1.6.1 Installing an expansion card

To install an expansion card:

1. Before installing the expansion card, read the documentation that came with it and make the necessary hardware settings for the card.
2. Remove the system unit cover (if your motherboard is already installed in a chassis).
3. Remove the bracket opposite the slot that you intend to use. Keep the screw for later use.
4. Align the card connector with the slot and press firmly until the card is completely seated on the slot.
5. Secure the card to the chassis with the screw you removed earlier.
6. Replace the system cover.

### 1.6.2 Configuring an expansion card

After installing the expansion card, configure it by adjusting the software settings.

1. Turn on the system and change the necessary BIOS settings, if any. See Chapter 2 for information on BIOS setup.
2. Assign an IRQ to the card.
3. Install the software drivers for the expansion card.



---

When using PCI cards on shared slots, ensure that the drivers support "Share IRQ" or that the cards do not need IRQ assignments. Otherwise, conflicts will arise between the two PCI groups, making the system unstable and the card inoperable.

---

### 1.6.3 PCI slot

The PCI slot supports cards such as a LAN card, SCSI card, USB card, and other cards that comply with PCI specifications.

### 1.6.4 PCI Express x1 slot

This motherboard supports PCI Express x1 network cards, SCSI cards, and other cards that comply with the PCI Express specifications.

### 1.6.5 PCI Express x16 slot

This motherboard supports one PCI Express x16 graphics card that comply with the PCI Express specifications.

## 1.7 Jumpers

### 1. Clear RTC RAM (CLRRTC)

This jumper allows you to clear the Real Time Clock (RTC) RAM in CMOS. You can clear the CMOS memory of date, time, and system setup parameters by erasing the CMOS RTC RAM data. The onboard button cell battery powers the RAM data in CMOS, which include system setup information such as system passwords.

To erase the RTC RAM:

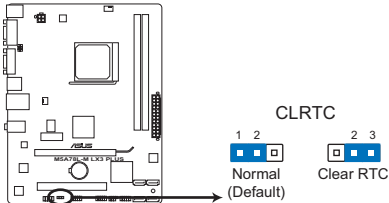

#### M5A78L-M LX3 PLUS Clear RTC RAM

1. Turn OFF the computer and unplug the power cord.
2. Move the jumper cap from pins 1-2 (default) to pins 2-3. Keep the cap on pins 2-3 for about 5~10 seconds, then move the cap back to pins 1-2.
3. Plug the power cord and turn ON the computer.
4. Hold down the **<Del>** key during the boot process and enter BIOS setup to reenter data.



---

Except when clearing the RTC RAM, never remove the cap on CLRRTC jumper default position. Removing the cap will cause system boot failure!

---



- If the steps above do not help, remove the onboard battery and move the jumper again to clear the CMOS RTC RAM data. After clearing the CMOS, reinstall the battery.
  - You do not need to clear the RTC when the system hangs due to overclocking. For system failure due to overclocking, use the CPU Parameter Recall (C.P.R) feature. Shut down and reboot the system so the BIOS can automatically reset parameter settings to default values.
-

## 2. Keyboard power (3-pin KBPWR)

This jumper allows you to enable or disable the keyboard wake-up feature. When you set this jumper to pins 2-3 (+5VSB), you can wake up the computer by pressing a key on the keyboard. This feature requires an ATX power supply that can supply at least 1A on the +5VSB lead, and a corresponding setting in the BIOS.

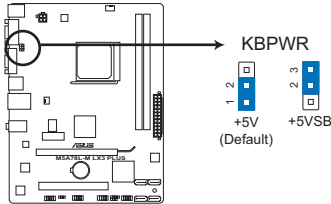

**M5A78L-M LX3 PLUS Keyboard power setting**

## 3. USB device wake-up (3-pin USBPW1-4, 3-pin USBPW5-8)

Set these jumpers to +5V to wake up the computer from S1 sleep mode (CPU stopped, DRAM refreshed, system running in low power mode) using the connected USB devices. Set to +5VSB to wake up from S3 and S4 sleep modes (no power to CPU, DRAM in slow refresh, power supply in reduced power mode).

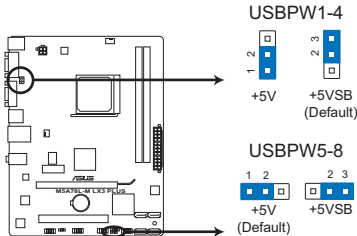

**M5A78L-M LX3 PLUS USB device wake-up**



- The USB device wake-up feature requires a power supply that can provide 500mA on the +5VSB lead for each USB port; otherwise, the system would not power up.
- The total current consumed must NOT exceed the power supply capability (+5VSB) whether under normal condition or in sleep mode.

## 1.8 Connectors

### 1.8.1 Rear panel ports

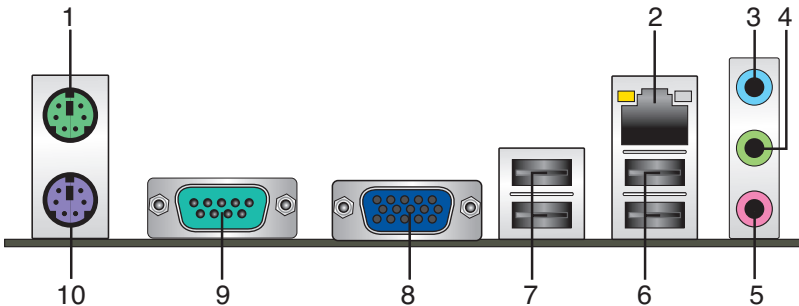

1. **PS/2 Mouse port (green).** This port is for a PS/2 mouse.
2. **LAN (RJ-45) port.** This port allows Gigabit connection to a Local Area Network (LAN) through a network hub.

#### LAN port LED indications

Activity/Link LED		Speed LED	
Status	Description	Status	Description
OFF	No link	OFF	10Mbps connection
ORANGE	Linked	ORANGE	100Mbps connection
BLINKING	Data activity	GREEN	1Gbps connection

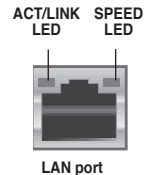

3. **Line In port (light blue).** This port connects the tape, CD, DVD player, or other audio sources.
4. **Line Out port (lime).** This port connects to a headphone or a speaker. In 4-channel, 6-channel, and 8-channel configurations, the function of this port becomes Front Speaker Out.
5. **Microphone port (pink).** This port connects a microphone.



Refer to the audio configuration table below for the function of the audio ports in the 2, 4, 6, or 8-channel configuration.

#### Audio 2, 4, 6, 8-channel configuration

Port	Headset 2-channel	4-channel	6-channel	8-channel
Light Blue (Rear panel)	Line In	Rear Speaker Out	Rear Speaker Out	Rear Speaker Out
Lime (Rear panel)	Line Out	Front Speaker Out	Front Speaker Out	Front Speaker Out
Pink (Rear panel)	Mic In	Mic In	Bass/Center	Bass/Center
Lime (Front panel)	-	-	-	Side Speaker Out



#### To configure an 8-channel audio output:

Use a chassis with HD audio module in the front panel to support an 8-channel audio output.

6. **USB 2.0 ports 1 and 2.** These two 4-pin Universal Serial Bus (USB) ports are for USB 2.0/1.1 devices.
7. **USB 2.0 ports 3 and 4.** These two 4-pin Universal Serial Bus (USB) ports are for USB 2.0/1.1 devices.
8. **Video Graphics Adapter (VGA) port.** This 15-pin port is for a VGA monitor or other VGA-compatible devices.
9. **COM port.** This port is for pointing devices or other serial devices.
10. **PS/2 Keyboard port (purple).** This port is for a PS/2 keyboard.

## 1.8.2 Internal connectors

### 1. Front panel audio connector (10-1 pin AAFP)

This connector is for a chassis-mounted front panel audio I/O module that supports either High Definition Audio or AC'97 audio standard. Connect one end of the front panel audio I/O module cable to this connector.

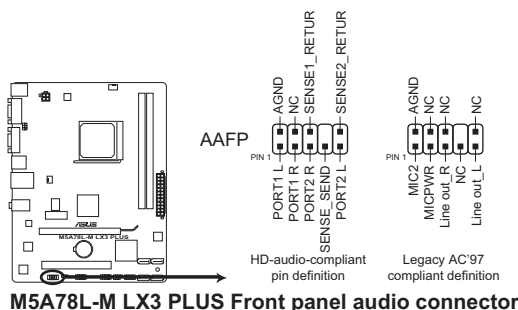

- We recommend that you connect a high-definition front panel audio module to this connector to avail of the motherboard high-definition audio capability.
- If you want to connect a high definition front panel audio module to this connector, set the **Front Panel Select** item in the BIOS to **[HD Audio]**. See section **2.4.4 Onboard Devices Configuration** for details.
- The front panel audio I/O module is purchased separately.

## 2. ATX power connectors (24-pin EATXPWR, 4-pin ATX12V)

These connectors are for an ATX power supply. The plugs from the power supply are designed to fit these connectors in only one orientation. Find the proper orientation and push down firmly until the connectors completely fit.

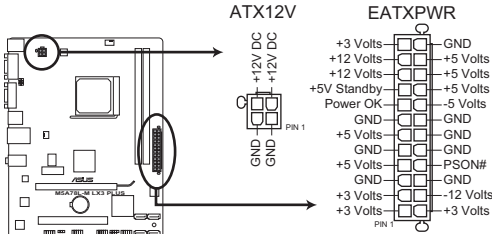

### M5A78L-M LX3 PLUS ATX power connectors



- We recommend that you use an ATX 12V Specification 2.0-compliant power supply unit (PSU) with a minimum of 300W power rating. This PSU type has 24-pin and 4-pin power plugs.
- If you intend to use a PSU with 20-pin and 4-pin power plugs, ensure that the 20-pin power plug can provide at least 15 A on +12 V and that the PSU has a minimum power rating of 300W. The system may become unstable or may not boot up if the power is inadequate.
- DO NOT forget to connect the 4-pin ATX +12V power plug. Otherwise, the system will not boot up.
- We recommend that you use a PSU with higher power output when configuring a system with more power-consuming devices or when you intend to install additional devices. The system may become unstable or may not boot up if the power is inadequate.
- If you are uncertain about the minimum power supply requirement for your system, refer to the Recommended Power Supply Wattage Calculator at <http://support.asus.com/PowerSupplyCalculator/PSCalculator.aspx?SLanguage=en-us> for details.

### 3. Serial ATA 3.0 Gb/s connectors (7-pin SATA3G\_1~4)

These connectors are for the Serial ATA 3.0 Gb/s signal cables for Serial ATA hard disk drives and optical disc drives. If you installed Serial ATA hard disk drives, you can create a RAID 0, RAID 1, or RAID 10 configuration through the onboard controller.

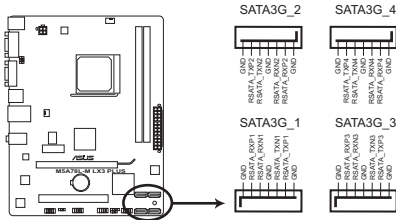

**M5A78L-M LX3 PLUS SATA 3.0Gb/s connectors**



- These connectors are set to **IDE** mode by default. In IDE mode, you can connect Serial ATA boot/data hard disk drives to these connectors. If you intend to create a Serial ATA RAID set using these connectors, set the type of the SATA connectors in the BIOS to **[RAID]**. See section **2.3.4 SATA Configuration** for details.
- You must install Windows® XP Service Pack 3 or later version before using Serial ATA hard disk drives. The Serial ATA RAID feature is available only if you are using Windows® XP SP3 or later version.
- When using hot-plug and NCQ, set the type of the SATA connectors in the BIOS to **[AHCI]**. See section **2.3.4 SATA Configuration** for details.



#### 4. System panel connector (10-1 pin F\_PANEL)

This connector supports several chassis-mounted functions.

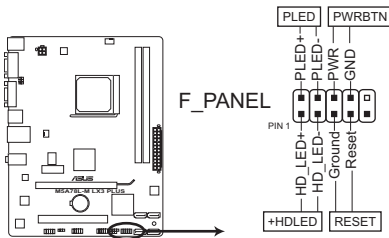

**M5A78L-M LX3 PLUS System panel connector**

- **System power LED (2-pin PLED)**

This 2-pin connector is for the system power LED. Connect the chassis power LED cable to this connector. The system power LED lights up when you turn on the system power, and blinks when the system is in sleep mode.

- **Hard disk drive activity LED (2-pin +HDLED)**

This 2-pin connector is for the HDD Activity LED. Connect the HDD Activity LED cable to this connector. The HD LED lights up or flashes when data is read from or written to the HDD.

- **ATX power button/soft-off button (2-pin PWRBTN)**

This 2-pin connector is for the system power button.

- **Reset button (2-pin RESET)**

This 2-pin connector is for the chassis-mounted reset button for system reboot without turning off the system power.

#### 5. Speaker connector (4-pin SPEAKER)

This 4-pin connector is for the chassis-mounted system warning speaker. The speaker allows you to hear system beeps and warnings.

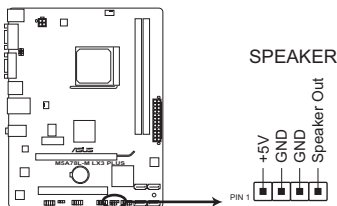

**M5A78L-M LX3 PLUS Speaker out connector**

## 6. USB 2.0 connectors (10-1 pin USB56, USB78)

These connectors are for USB 2.0 ports. Connect the USB module cable to any of these connectors, then install the module to a slot opening at the back of the system chassis. These USB connectors comply with USB 2.0 specification that supports up to 480Mbps connection speed.

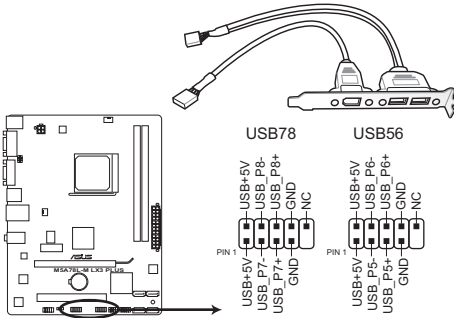

**M5A78L-M LX3 PLUS USB2.0 connectors**



Never connect a 1394 cable to the USB connectors. Doing so will damage the motherboard!



The USB 2.0 module is purchased separately.

## 7. CPU and chassis fan connectors (4-pin CPU\_FAN and 3-pin CHA\_FAN)

Connect the fan cables to the fan connectors on the motherboard, ensuring that the black wire of each cable matches the ground pin of the connector.

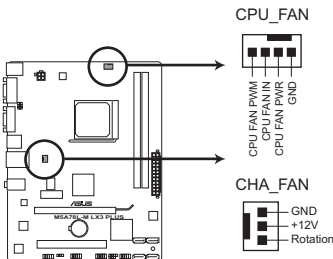

**M5A78L-M LX3 PLUS fan connectors**



DO NOT forget to connect the fan cables to the fan connectors. Insufficient air flow inside the system may damage the motherboard components. These are not jumpers! DO NOT place jumper caps on the fan connectors.



Only the 4-pin CPU fan connector supports the ASUS Fan Xpert feature.

## 1.9 Software support

### 1.9.1 Installing an operating system

This motherboard supports Windows® XP / Vista / 7 Operating Systems (OS). Always install the latest OS version and corresponding updates to maximize the features of your hardware.



- Motherboard settings and hardware options vary. Refer to your OS documentation for detailed information.
- Ensure that you install Windows® XP Service Pack 3 or later versions / Windows® Vista Service Pack 1 or later versions before installing the drivers for better compatibility and system stability.

### 1.9.2 Support DVD information

The Support DVD that comes with the motherboard package contains the drivers, software applications, and utilities that you can install to avail all motherboard features.



The contents of the Support DVD are subject to change at any time without notice. Visit the ASUS website at [www.asus.com](http://www.asus.com) for updates.

### To run the Support DVD

Place the Support DVD into the optical drive. If Autorun is enabled in your computer, the DVD automatically displays the Specials screen. Click Drivers, Utilities, Make Disk, Manual, and Contact tabs to display their respective menus.



The following screen is for reference only.

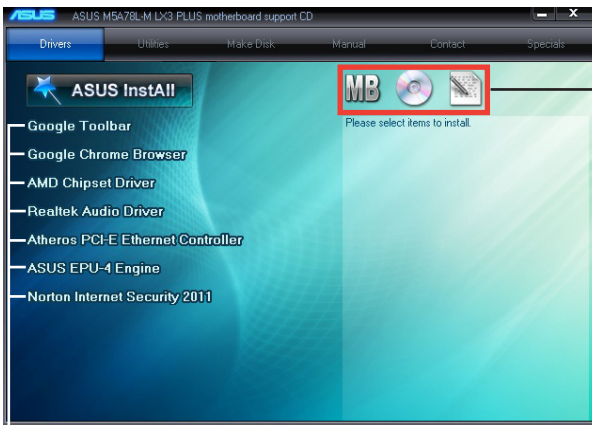

Click an icon to display Support DVD/motherboard information

Click an item to install



If Autorun is NOT enabled on your computer, browse the contents of the Support DVD to locate the file ASSETUP.EXE from the BIN folder. Double-click the ASSETUP.EXE to run the DVD.



# BIOS information

# 2

## 2.1 Managing and updating your BIOS



---

Save a copy of the original motherboard BIOS file to a USB flash disk in case you need to restore the BIOS in the future. Copy the original motherboard BIOS using the ASUS Update utility.

---

### 2.1.1 ASUS Update utility

The ASUS Update is a utility that allows you to manage, save, and update the motherboard BIOS in Windows® environment.



- 
- ASUS Update requires an Internet connection either through a network or an Internet Service Provider (ISP).
  - This utility is available in the support DVD that comes with the motherboard package.
- 

### Installing ASUS Update

#### To install ASUS Update:

1. Place the support DVD in the optical drive. The **Specials** menu appears.
2. Click the **Utilities** tab, then click **AI Suite II**.
3. Follow the onscreen instructions to complete the installation.



---

Quit all Windows® applications before you update the BIOS using this utility.

---

### Updating the BIOS

#### To update the BIOS:

1. From the Windows® desktop, click **Start > Programs > ASUS > AI Suite II > AI Suite II X.XX.XX** to launch the AI Suite II utility. The AI Suite II Quick Bar appears.
2. Click **Update** button from the Quick Bar, and then click **ASUS Update** from the popup menu. The **ASUS Update** main screen appears. From the list, select either of the following methods:

### *Updating from the Internet*

- a. Select **Update BIOS from the Internet**, then click **Next**.
- b. Select the ASUS FTP site nearest you to avoid network traffic, then click **Next**.
- c. From the FTP site, select the BIOS version that you wish to download then click **Next**.



---

The ASUS Update utility is capable of updating itself through the Internet. Always update the utility to avail all its features.

---

### *Updating from a BIOS file*

- a. Select **Update BIOS from file**, then click **Next**.
  - b. Locate the BIOS file from the **Open** window, then click **Open**.
3. Follow the onscreen instructions to complete the updating process.

## **2.1.2 ASUS EZ Flash 2 utility**

The ASUS EZ Flash 2 feature allows you to update the BIOS without using an OS-based utility.



---

Before you start using this utility, download the latest BIOS file from the ASUS website at [www.asus.com](http://www.asus.com).

---

To update the BIOS using EZ Flash 2:

1. Insert the USB flash disk that contains the latest BIOS file to the USB port, then launch EZ Flash 2 in either of these two ways:
  - Press **<Alt> + <F2>** during POST.
  - Enter the BIOS setup program. Go to the **Tools** menu to select **EZ Flash 2** and press **<Enter>** to enable it.

Press **<Tab>** to switch between drives until the correct BIOS file is found.
2. When the correct BIOS file is found, EZ Flash 2 performs the BIOS update process and automatically reboots the system when done.



- 
- This function supports USB flash disks with **FAT 32/16** format and single partition only.
  - **DO NOT** shut down or reset the system while updating the BIOS to prevent system boot failure!
-

### 2.1.3 ASUS CrashFree BIOS 3

ASUS CrashFree BIOS 3 is an auto recovery tool that allows you to restore the BIOS file when it fails or gets corrupted during the updating process. You can restore a corrupted BIOS file using the motherboard support DVD or a USB flash drive that contains the updated BIOS file.



- 
- Before using this utility, rename the BIOS file in the USB flash drive into **MA78LLX3.ROM** (for M5A78L-M LX3) or **MA78LL3P.ROM** (for M5A78L-M LX3 PLUS).
  - Download the latest BIOS file from the ASUS website at [www.asus.com](http://www.asus.com).
- 

### Recovering the BIOS

To recover the BIOS:

1. Turn on the system.
2. Insert the support DVD to the optical drive or the USB flash drive that contains the BIOS file to the USB port.
3. The utility automatically checks the devices for the BIOS file. When found, the utility reads the BIOS file and starts flashing the corrupted BIOS file.
4. Turn off the system after the utility completes the updating process and turn on again.



---

DO NOT shut down or reset the system while updating the BIOS! Doing so can cause system boot failure!

---



---

Ensure to load the BIOS default settings to ensure system compatibility and stability. Select the **Load Setup Defaults** item under the Exit menu. Refer to section **2.8 Exit menu** for details.

---

## 2.2 BIOS setup program

Use the BIOS Setup program to update the BIOS or configure its parameters. The BIOS screens include navigation keys and brief online help to guide you in using the BIOS Setup program.

### Entering BIOS Setup at startup

To enter BIOS Setup at startup:

- Press **<Delete>** during the Power-On Self-Test (POST). If you do not press **<Delete>**, POST continues with its routines.

### Entering BIOS Setup after POST

To enter BIOS Setup after POST:

- Press **<Ctrl>+<Alt>+<Delete>** simultaneously.
- Press the reset button on the system chassis.
- Press the power button to turn the system off then back on. Do this option only if you failed to enter BIOS Setup using the first two options.



Using the **power button**, **reset button**, or the **<Ctrl>+<Alt>+<Del>** keys to force reset from a running operating system can cause damage to your data or system. We recommend that you always shut down the system properly from the operating system.

---



- The default BIOS settings for this motherboard apply to most conditions to ensure optimum performance. If the system becomes unstable after changing any BIOS settings, load the default settings to ensure system compatibility and stability. Select the **Load Setup Defaults** item under the **Exit** menu. See section **2.8 Exit Menu**.
  - The BIOS setup screens in this chapter are for reference only. They may not exactly match what you see on your screen.
  - Visit the ASUS website at [www.asus.com](http://www.asus.com) to download the latest BIOS file for this motherboard.
-



## 2.2.1 BIOS menu screen

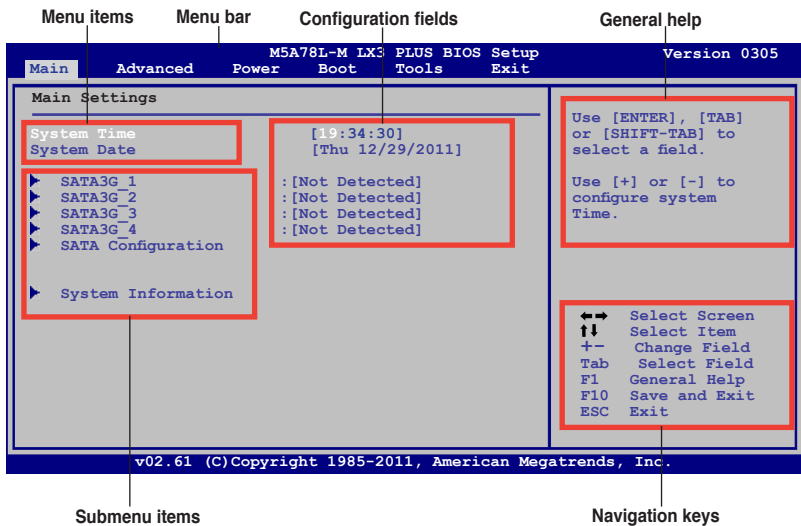

## 2.2.2 Menu bar

The menu bar on top of the screen has the following main items:

- Main** For changing the basic system configuration
- Advanced** For changing the advanced system settings
- Power** For changing the advanced power management (APM) configuration
- Boot** For changing the system boot configuration
- Tools** For configuring options for special functions
- Exit** For selecting the exit options and loading default settings.

To select an item on the menu bar, press the right or left arrow key on the keyboard until the desired item is highlighted.

## 2.2.3 Navigation keys

At the bottom right corner of a menu screen are the navigation keys for that particular menu. Use the navigation keys to select items in the menu and change the settings.



Some of the navigation keys differ from one screen to another.



## 2.3 Main menu

When you enter the BIOS Setup program, the Main menu screen appears, giving you an overview of the basic system information.



Refer to section 2.2.1 **BIOS menu screen** for information on the menu screen items and how to navigate through them.

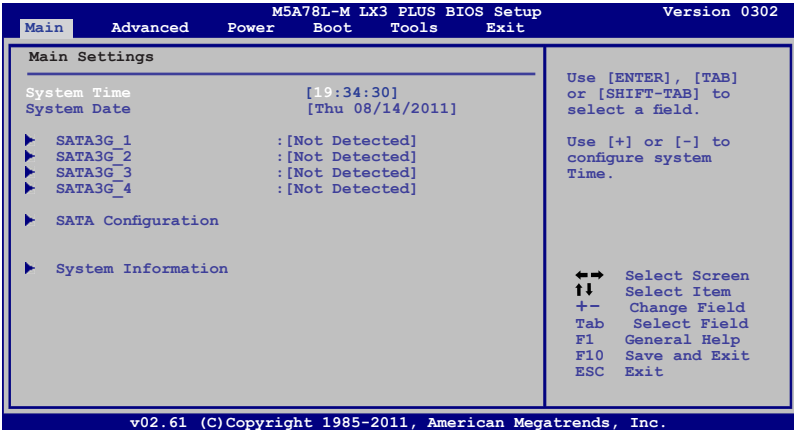

### 2.3.1 System Time [xx:xx:xx]

Allows you to set the system time.

### 2.3.2 System Date [Day xx/xx/xxxx]

Allows you to set the system date.

### 2.3.3 SATA3G\_1~4

While entering Setup, the BIOS automatically detects the presence of SATA devices. There is a separate submenu for each SATA device. Select a device item then press **<Enter>** to display the SATA device information.

The BIOS automatically detects the values opposite the dimmed items (Device, LBA/Large Mode, Block (Multi-Sector Transfer) Mode, PIO Mode, DMA Mode, SMART monitoring and 32Bit Data Transfer). These values are not user-configurable. These items show Not Detected if no SATA device is installed in the system.

#### LBA/Large Mode [Auto]

Enables or disables the LBA mode. Setting this item to **[Auto]** enables the LBA mode if the device supports this mode, and if the device was not previously formatted with LBA mode disabled. Configuration options: [Disabled] [Auto]

#### Block (Multi-Sector Transfer) M [Auto]

Enables or disables data multi-sectors transfers. When this item is set to **[Auto]**, the data transfer from and to the device occurs multiple sectors at a time if the device supports multi-sector transfer feature. When this item is set to **[Disabled]**, the data transfer from and to the device occurs one sector at a time. Configuration options: [Disabled] [Auto]

### **PIO Mode [Auto]**

Selects the PIO mode. Configuration options: [Auto] [0] [1] [2] [3] [4]

### **DMA Mode [Auto]**

Selects the DMA mode. Configuration options: [Auto]

### **SMART Monitoring [Auto]**

Sets the Smart Monitoring, Analysis, and Reporting Technology. Configuration options: [Auto] [Disabled] [Enabled]

### **32Bit Data Transfer [Enabled]**

Enables or disables 32-bit data transfer. Configuration options: [Disabled] [Enabled]

## **2.3.4 SATA Configuration**

The **SATA Configuration** menu allows you to configure your storage devices. Select an item then press **<Enter>** to display the submenu.

### **OnChip SATA Channel [Enabled]**

Enables or disables the onboard channel SATA port. Configuration options: [Disabled] [Enabled]



---

The following item only appears when you set **OnChip SATA Channel** to **[Enabled]**.

---

#### *SATA Port1 - Port4 [IDE]*

Allows you to set the SATA configuration.

- |        |  |
|--------|--|
| [IDE]  | Set to [IDE] when you want to use the Serial ATA hard disk drives as Parallel ATA physical storage devices.  |
| [RAID] | Set to [RAID] when you want to create a RAID configuration from the SATA hard disk drives.   |
| [AHCI] | Set to [AHCI] when you want the SATA hard disk drives to use the AHCI (Advanced Host Controller Interface). The AHCI allows the onboard storage driver to enable advanced Serial ATA features that increases storage performance on random workloads by allowing the drive to internally optimize the order of commands. |

## **2.3.5 System Information**

This menu gives you an overview of the general system specifications. The BIOS automatically detects the items in this menu.

### **BIOS Information**

Displays the auto-detected BIOS information.

### **Processor**

Displays the auto-detected CPU specification.

### **System Memory**

Displays the auto-detected system memory.

## 2.4 Advanced menu

The **Advanced** menu items allow you to change the settings for the CPU and other system devices.



Take caution when changing the settings of the Advanced menu items. Incorrect field values can cause the system to malfunction.

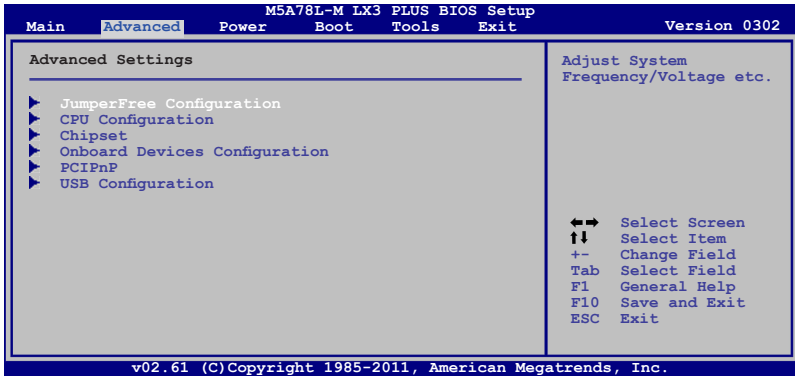

### 2.4.1 JumperFree Configuration



The items and configuration options in this menu may vary depending on the AMD CPU type.

#### CPU OverClocking [Overclock Profile]

Selects the CPU overclocking options to achieve desired CPU internal frequency.  
Configuration options: [Manual] [Auto] [Overclock Profile] [Test Mode]



The following item appears only when you set **CPU Overclocking** to **[Manual]**.

##### CPU/HT Reference Clock (MHz) [200]

Sets the CPU/HT Reference Clock. Configuration options: [Min.=200] [Max.=550]



The following item appears only when you set **CPU Overclocking** to **[Overclock Profile]**.

##### Overclock Options [Overclock 5%]

Selects the overclocking profile. Configuration options: [Auto] [Overclock 2%]  
[Overclock 5%] [Overclock 8%] [Overclock 10%]

#### GPU Overclocking [Auto]

Configures the GPU overclocking. Configuration options: [Auto] [Manual]



The following item appears only when you set **GPU Overclocking** to **[Manual]**.

##### GPU Engine Clock [350]

Sets the GPU Engine Clock. Use <+> / <-> keys to adjust the ratio or input a number between 200 and 350.

## PCIe Overclocking [Auto]

Configures the PCIe overclocking. Configuration options: [Auto] [Manual]



---

The following item only appears when you set **PCIe Overclocking** to [Manual].

---

### *PCIe Clock [100]*

Sets the PCIe Clock. Use <+> / <-> keys to adjust the ratio or input a number between 100 and 150.

## CPU Ratio [Auto]

Sets the CPU ratio. Configuration options:[Auto] [x4.0 800MHz] [x4.5 900MHz] [x5.0 1000MHz] [x5.5 1100MHz] [x6.0 1200MHz] [x6.5 1300MHz] [x7 1400MHz] [x7.5 1500MHz] [x8.0 1600MHz] [x8.5 1700MHz] [x9 1800MHz] [x9.5 1900MHz] [x10.0 2000MHz] [x10.5 2100MHz] [x11 2200MHz]

## CPU/NB Frequency [Auto]

Sets the CPU/Northbridge frequency. Configuration options: [Auto] [840MHz] [1050MHz] [1260MHz] [1470MHz] [1680MHz] [1890MHz] [2100MHz]

## CPU Over Voltage [Auto]

Sets the CPU over voltage. The valid value ranges vary depending on your CPU model. Use <+> / <-> keys to adjust the ratio. Configuration options: [Auto]

## VDDNB Over Voltage [Auto]

Sets the VDDNB over voltage. The valid value ranges vary depending on your CPU model. Use <+> / <-> keys to adjust the ratio. Configuration options: [Auto]

## LoadLine Calibration [Auto]

Sets the LoadLine. Configuration options: [Auto] [0%] [3.225%] [6.450%] [9.675%] [12.90%] ~ [87.075%] [90.3%] [93.525%] [96.75%] [100%]



---

If the system becomes unstable after changing the setting, set it back to [Auto] for safe mode.

---

## HT Link Speed [Auto]

Sets the HyperTransport link speed. Configuration options: [Auto] [210MHz] [420MHz] [630MHz] [840MHz] [1050MHz] [1260MHz] [1470MHz] [1680MHz] [1890MHz] [2100MHz]

## DRAM Timing Config [Auto]

Configuration options: [Auto] [Manual]



---

The following items only appear when you set **DRAM Timing Config** to [Manual].

---

### *Memory Clock Speed [400MHz]*

Selects the memory clock frequency programming method. Configuration options: [400MHz] [533MHz] [667MHz] [800MHz]

## DRAM Timing Configuration



The configuration options for some of the following items vary depending on the DIMMs you install on the motherboard.

### *DRAM CAS# Latency [Auto]*

Configuration options: [Auto] [4 CLK] ~ [12 CLK]

### *DRAM RAS# to CAS# Delay [Auto]*

Configuration options: [Auto] [5 CLK] ~ [12 CLK]

### *DRAM RAS# PRE Time [Auto]*

Configuration options: [Auto] [5 CLK] ~ [12 CLK]

### *DRAM RAS# ACT Time [Auto]*

Configuration options: [Auto] [15 CLK] ~ [30 CLK]

### *DRAM READ to PRE Time [Auto]*

Configuration options: [Auto] [4 CLK] [5 CLK] [6 CLK] [7 CLK]

### *DRAM Row Cycle Time [Auto]*

Configuration options: [Auto] [12 CLK] ~ [42 CLK]

### *DRAM WRITE Recovery Time [Auto]*

Configuration options: [Auto] [5 CLK] [6 CLK] [7 CLK] [8 CLK] [10 CLK] [12 CLK]

### *DRAM RAS# to RAS# Delay [Auto]*

Configuration options: [Auto] [4 CLK] [5 CLK] [6 CLK] [7 CLK]

### *DRAM READ to WRITE Delay [Auto]*

Configuration options: [Auto] [3 CLK] ~ [17 CLK]

### *DRAM WRITE to READ Delay(DD) [Auto]*

Configuration options: [Auto] [2 CLK] ~ [10 CLK]

### *DRAM WRITE to READ Delay(SD) [Auto]*

Configuration options: [Auto] [4 CLK] [5 CLK] [6 CLK] [7 CLK]

### *DRAM WRITE to WRITE Timing [Auto]*

Configuration options: [Auto] [2 CLK] ~ [10 CLK]

### *DRAM READ to READ Timing [Auto]*

Configuration options: [Auto] [3 CLK] ~ [10 CLK]

### *DRAM REF Cycle Time [Auto]*

Configuration options: [Auto] [90ns] [110ns] [160ns] [300ns] [350ns]

### *DRAM Refresh Rate [Auto]*

Configuration options: [Auto] [Every 7.8ms] [Every 3.9ms]

### *DRAM Command Rate [Auto]*

Configuration options: [Auto] [1T] [2T]

## Memory Voltage [Auto]

Sets the memory voltage. Configuration options: [Auto] [1.350V] [1.500V] [1.650V] [1.800V]

## PCI/PCIe CLK Status [Enabled]

Enables or disables clock for PCI/PCIe slot. Configuration options: [Disabled] [Enabled]

## 2.4.2 CPU Configuration

The items in this menu show the CPU-related information that the BIOS automatically detects.

### GART Error Reporting [Disabled]

This option should remain disabled for the normal operation. The driver developer may enable it for testing purpose. Configuration options: [Disabled] [Enabled]

### Microcode Update [Enabled]

Enables or disables Microcode Update. Configuration options: [Disabled] [Enabled]

### Secure Virtual Machine Mode [Disabled]

Enables or disables Secure Virtual Machine Mode (SVM). Configuration options: [Disabled] [Enabled]

### Cool 'n' Quiet [Enabled]

Enables or disables the AMD® Cool 'n' Quiet technology. Configuration options: [Enabled] [Disabled]

### C1E Support [Disabled]

Enables or disables the CPU Enhanced Halt (C1E) function, a CPU power-saving function in system halt state. When this item is enabled, the CPU core frequency and voltage will be reduced during the system halt state to decrease power consumption. Configuration options: [Disabled] [Enabled]

### Advanced Clock Calibration [Disabled]

Adjusts the processor's overclocking capability. When this item is set to **[Auto]**, the BIOS automatically adjusts this function. When this item is set to **[All Cores]**, the processor has the best overclocking performance. When this item is set to **[Per Core]**, the processor's overclocking capability is enhanced. Configuration options: [Disabled] [Auto] [All Cores] [Per Core]



---

The following items appear only when you set **Advanced Clock Calibration** to **[Auto]**, **[All Cores]**, or **[Per Core]**.

---

#### Unleashing Mode [Disabled]

Enable the Unleashing Mode to get full computing power of the processor. However, this might make your system unstable depending on your processor's overclocking capability. Configuration options: [Enabled] [Disabled]

#### Active CPU Cores [Auto]

Allows you to manually turn ON/OFF a process core. Configuration options: [Auto] [Manual]

#### **2nd / 3rd / 4th Core [On]**

These items appear only when you set **Active CPU Cores** to **[Manual]**. Configuration options: [On] [Off]

#### **Value (All Cores) [-2%]**

This item appears only when you set **Advanced Clock Calibration** to **[All Cores]**. It allows you to set the overclocking percentage for all the processor cores as a whole. Configuration options: [0%] [+2%] [+4%] [+6%] [+8%] [+10%] [+12%] [-2%] [-4%] [-6%] [-8%] [-10%] [-12%]



### Value (Core 0) / (Core 1) / (Core 2) / (Core 3) [-2%]

These items only appear when you set **Advanced Clock Calibration** to **[Per Core]** and allow you to set the overclocking percentage for each process core separately. Configuration options: [0%] [+2%] [+4%] [+6%] [+8%] [+10%] [+12%] [-2%] [-4%] [-6%] [-8%] [-10%] [-12%]

## 2.4.3 Chipset

### NorthBridge Configuration

#### DRAM Controller Configuration

##### *Bank Interleaving [Auto]*

Allows you to enable the bank memory interleaving. Configuration options: [Disabled] [Auto]

##### *Node Interleaving [Disabled]*

Allows you to enable the node memory interleaving. Configuration options: [Disabled] [Auto]

##### *Channel Interleaving [Auto]*

Allows you to enable the channel memory interleaving. Configuration options: [Disabled] [Auto]

##### *Memory Hole Remapping [Enabled]*

Allows you to enable or disable memory remapping around memory hole. Configuration options: [Disabled] [Enabled]

##### *DCT Unganged Mode [Always]*

Allows you to select unganged DRAM mode (64-bit width). Configuration options: [Always] [Auto]

##### *Power Down Enable [Enabled]*

Allows you to enable or disable DDR power down mode. Configuration options: [Disabled] [Enabled]

#### ECC Configuration

##### *ECC Mode [Disabled]*

Enables or disables the DRAM ECC that allows the hardware to report and correct memory errors automatically. Configuration options: [Disabled] [Basic] [Good] [Super] [Max] [User]

#### Internal Graphics

#### Primary Video Controller [GFX0-GPP-IGFX-PCI]

Selects the primary display adapter. Configuration options: [GFX0-GPP-IGFX-PCI] [GPP-GFX0-IGFX-PCI] [PCI-GFX0-GPP-IGFX] [IGFX-GFX0-GPP-PCI]



---

GFX0: primary video controller on a PCIe x16 slot  
GPP: primary video controller on a PCIe x1 slot  
IGFX: onboard display output port  
PCI: primary video controller on a PCI slot

---

#### UMA Frame Buffer Size [Auto]

Selects the UMA frame buffer size. Configuration options: [Auto] [32MB] [64MB] [128MB] [256MB] [512MB] [1GB]



- The **[512MB]** option only appears when you install 1GB system memory or more.
- The **[1GB]** option only appears when you install 2GB system memory or more.

### **Surround View [Auto]**

Disables or enables the Surround View function. Configuration options: [Auto] [Disabled] [Enabled]



This item becomes user-configurable when you install an ATI graphics card into the PCIe x16 slot.

### **Frame Buffer Location [Above 4G]**

Configuration options: [Below 4G] [Above 4G]

## **2.4.4 Onboard Devices Configuration**

### **Serial Port1 Address [3F8/IRQ4]**

Allows you to select the Serial Port1 base address. Configuration options: [Disabled] [3F8/IRQ4][2F8/IRQ3] [3E8/IRQ4] [2E8/IRQ3]

### **HDAudio Controller [Enabled]**

Enables or disables the high definition audio controller. Configuration options: [Disabled] [Enabled]

#### Front Panel Select [HD Audio]

This item appears only when you set the previous item to [Enabled]. Configuration options: [AC97] [HD Audio]

### **OnBoard LAN Controller [Enabled]**

Configuration options: [Disabled] [Enabled]

#### OnBoard LAN Boot ROM [Disabled]

This item appears only when you set the previous item to [Enabled]. Configuration options: [Disabled] [Enabled]

## **2.4.5 PCIPnP**

The PCI PnP menu items allow you to change the advanced settings for PCI/PnP devices. The menu includes setting IRQ and DMA channel resources for either PCI/PnP or legacy ISA devices, and setting the memory size block for legacy ISA devices.



Take caution when changing the settings of the PCI PnP menu items. Incorrect field values can cause the system to malfunction.

### **Plug and Play O/S [No]**

When this item is set to **[No]**, BIOS configures all the devices in the system. When this item is set to **[Yes]** and if you install a Plug and Play operating system, the operating system configures the Plug and Play devices not required for boot. Configuration options: [No] [Yes]

## 2.4.6 USB Configuration

The items in this menu allows you to change the USB-related features. Select an item then press **<Enter>** to display the configuration options.



---

The Module Version and USB Devices Enabled items show the auto-detected values. If no USB device is detected, the item shows **None**.

---

### USB Functions [Enabled]

Allows you to enable or disable the USB functions. Configuration options: [Disabled] [Enabled]



---

The following items appear only when you set **USB Functions** to **[Enabled]**.

---

### USB 2.0 Controller [Enabled]

Enables or disables USB 2.0 Controllers. Configuration options: [Disabled] [Enabled]

### Legacy USB Support [Auto]

Allows you to enable or disable support for Legacy USB storage devices, including USB flash drives and USB hard drives. Setting to Auto allows the system to detect the presence of USB devices at startup. If detected, the USB controller legacy mode is enabled. If no USB device is detected, the legacy USB support is disabled. Configuration options: [Disabled] [Enabled] [Auto]

### USB 2.0 Controller Mode [HiSpeed]

Allows you to configure the USB 2.0 controller in HiSpeed (480Mbps) or Full Speed (12Mbps). Configuration options: [FullSpeed] [HiSpeed]



---

The following items only appear when a USB storage device is plugged in.

---

## USB Mass Storage Device Configuration

### USB Mass Storage Reset Delay [20 Sec]

Sets the maximum time that the BIOS waits for the USB storage device to initialize. Configuration options: [10 Sec] [20 Sec] [30 Sec] [40 Sec]

#### *Emulation Type [Auto]*

Allows you to set the emulation type. Configuration options: [Auto] [Floppy] [Forced FDD] [Hard Disk] [CDROM]

## 2.5 Power menu

The Power menu items allow you to change the settings for the Advanced Configuration and Power Interface (ACPI) and the Advanced Power Management (APM). Select an item then press **<Enter>** to display the configuration options.

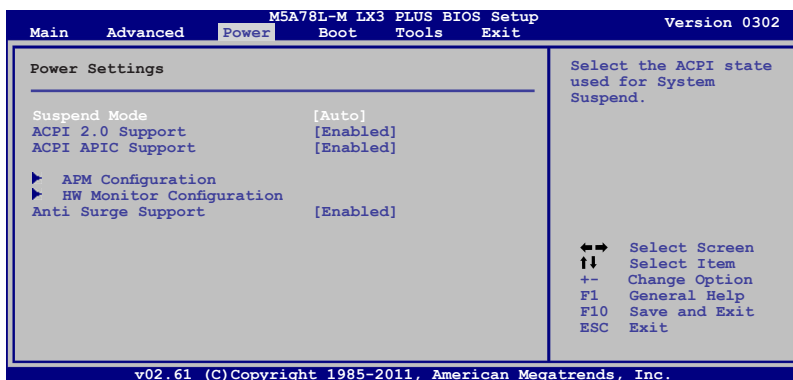

### 2.5.1 Suspend Mode [Auto]

Allows you to select the Advanced Configuration and Power Interface (ACPI) state to be used for system suspend. Configuration options: [S1 (POS) Only] [S3 Only] [Auto]

### 2.5.2 ACPI 2.0 Support [Enabled]

Allows you to enable or disable the Advanced Configuration and Power Interface (ACPI) 2.0 support. Configuration options: [Disabled] [Enabled]

### 2.5.3 ACPI APIC Support [Enabled]

Allows you to enable or disable the Advanced Configuration and Power Interface (ACPI) support in the Advanced Programmable Interrupt Controller (APIC). When set to Enabled, the ACPI APIC table pointer is included in the RSDT pointer list. Configuration options: [Disabled] [Enabled]

### 2.5.4 APM Configuration

#### Restore on AC Power Loss [Power Off]

When this item is set to **[Power Off]**, the system goes into off state after an AC power loss. When this item is set to **[Power On]**, the system goes on after an AC power loss. When this item set to **[Last State]**, the system goes into either off or on state, whatever the system state was before the AC power loss. Configuration options: [Power Off] [Power On] [Last State]

#### Power on From S5 By PME# [Disabled]

Enables or disables PME wake from sleep states. Configuration options: [Disabled] [Enabled]

#### Power on From S5 By Ring [Disabled]

Enables or disables ring to generate a wake event. Configuration options: [Disabled] [Enabled]

### Power on By PS/2 Keyboard [Disabled]

Enables or disables PS/2 Keyboard to generate a wake event. Configuration options: [Disabled] [Space Bar] [Power Key] [Ctrl-Esc]

### Power on From S5 By RTC Alarm [Disabled]

Enables or disables RTC to generate a wake event. Configuration options: [Disabled] [Enabled]

## 2.5.5 HW Monitor Configuration

### CPU Temperature [xxx°C/xxx°F] or [Ignored]

### MB Temperature [xxx°C/xxx°F] or [Ignored]

The onboard hardware monitor automatically detects and displays the motherboard and CPU temperatures. Select Ignored if you do not wish to display the detected temperatures.

### CPU / Chassis Fan Speed [N/A], [xxxxRPM], or [Ignored]

The onboard hardware monitor automatically detects and displays the CPU / Chassis fan speeds in rotations per minute (RPM). If the fan is not connected to the motherboard, the field shows N/A. Select **Ignored** if you do not want the detected speed to be displayed.

### VCORE Voltage, 3.3V Voltage, 5V Voltage, 12V Voltage [xx.xxxV] or [Ignored]

The onboard hardware monitor automatically detects the voltage output through the onboard voltage regulators.

### CPU Q-Fan Function [Enabled]

Enables or disables the ASUS Q-Fan feature that smartly adjusts the CPU fan speeds for more efficient system operation. Configuration options: [Disabled] [Enabled]



---

The following items appear only when you set **CPU Q-Fan Function** to **[Enabled]**.

---

#### *CPU Fan Speed Low Limit [200 RPM]*

Allows you to manually set a lower limit for the CPU fan speed. If the CPU fan speed is below the specified limit, the system sends out warning beeps. Configuration options: [600 RPM] [500 RPM] [400 RPM] [300 RPM] [200 RPM] [Ignored]

#### *CPU Q-Fan Mode [Standard]*

Allows you to set the appropriate performance level of the CPU fan.

- |            |   |
|------------|---|
| [Standard] | Sets to [Standard] to make the CPU fan automatically adjust depending on the CPU temperature. |
| [Silent]   | Sets to [Silent] to minimize the fan speed for quiet CPU fan operation.                       |
| [Turbo]    | Set to [Turbo] to achieve maximum CPU fan speed.  |
| [Manual]   | Allows you to individually set the CPU fan parameters.  |



---

The following four items appear only when you set **CPU Q-Fan Mode** to **[Manual]**.

---

#### **CPU Upper Temperature [70°C/158°F]**

Allows you to select the CPU upper temperature. Configuration options: [30°C/86°F] [40°C/104°F] [50°C/122°F] [60°C/140°F] [70°C/158°F] [80°C/176°F] [90°C/194°F]

**CPU Fan Max. Duty Cycle(%) [100%]**

Allows you to select the maximum CPU fan duty cycle. When the CPU temperature reaches the upper limit, the CPU fan will operate at the maximum duty cycle. Configuration options: [20%] [30%] [40%] [50%] [60%] [70%] [80%] [90%] [100%].

**CPU Lower Temperature [20°C/68°F]**

Displays the lower limit of the CPU temperature.

**CPU Fan Min. Duty Cycle(%) [20%]**

Allows you to select the minimum CPU fan duty cycle. When the CPU temperature is under 40°C, the CPU fan will operate at the minimum duty cycle. Configuration options: [00%] [10%] [20%] [30%] [40%] [50%] [60%] [70%] [80%] [90%] [100%].

## 2.5.6 Anti Surge Support [Enabled]

Allows you to enable or disable the Anti-Surge protection feature. Configuration options: [Disabled] [Enabled]

## 2.6 Boot menu

The **Boot** menu items allow you to change the system boot options. Select an item then press **<Enter>** to display the submenu.

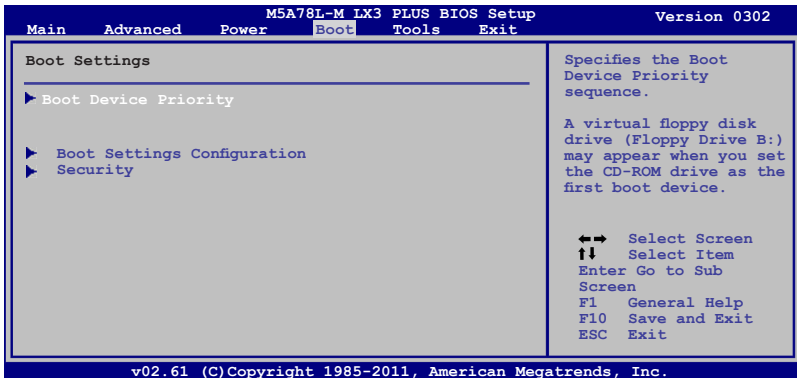

### 2.6.1 Boot Device Priority

#### 1st ~ xxth Boot Device

These items specify the boot device priority sequence from the available devices. The number of device items that appears on the screen depends on the number of devices installed in the system. Configuration options: [Removable Dev.] [Hard Drive] [ATAPI CD-ROM] [Disabled]



- To select the boot device during system startup, press **<F8>** when ASUS logo appears.
- To access Windows OS in Safe Mode, press **<F8>** after POST.

### 2.6.2 Boot Settings Configuration

#### Quick Boot [Enabled]

Enabling this item allows the BIOS to skip some power on self tests (POST) while booting to decrease the time needed to boot the system. When this item is set to **[Disabled]**, BIOS performs all the POST items. Configuration options: [Disabled] [Enabled]

#### Full Screen Logo [Enabled]

Enables or disables the full screen logo display feature. Configuration options: [Disabled] [Enabled]



Set this item to **[Enabled]** to use the ASUS MyLogo2™ feature.

### **AddOn ROM Display Mode [Force BIOS]**

Sets the display mode for option ROM. Configuration options: [Force BIOS] [Keep Current]

### **Bootup Num-Lock [On]**

Selects the power-on state for the NumLock. Configuration options: [Off] [On]

### **Wait for 'F1' If Error [Enabled]**

When this item is set to [Enabled], the system waits for the F1 key to be pressed when error occurs. Configuration options: [Disabled] [Enabled]

### **Hit 'DEL' Message Display [Enabled]**

When this item is set to [Enabled], the system displays the message **Press DEL to run Setup** during POST. Configuration options: [Disabled] [Enabled]

## **2.6.3 Security**

The Security menu items allow you to change the system security settings. Select an item then press **<Enter>** to display the configuration options.

### **Change Supervisor Password**

Select this item to set or change the supervisor password. The **Supervisor Password** item on top of the screen shows the default **Not Installed**. After you set a password, this item shows **Installed**.

To set a Supervisor Password:

1. Select the **Change Supervisor Password** item and press **<Enter>**.
2. On the password box, key in a password containing up to six letters, or numbers, or both, then press **<Enter>**.
3. Confirm the password when prompted.

The message **Password Installed** appears after you successfully set your password.

To change the supervisor password, follow the same steps as in setting a supervisor password.

To clear the supervisor password, select the **Change Supervisor Password** then press **<Enter>** twice. The message **Password uninstalled** appears.



---

If you forget your BIOS password, you can clear it by erasing the CMOS Real Time Clock (RTC) RAM. See section 1.7 **Jumpers** for information on how to erase the RTC RAM.

---



After you have set a supervisor password, the other items appear to allow you to change other security settings.

### **User Access Level [Full Access]**

This item allows you to select the access restriction to the Setup items. Configuration options: [No Access] [View Only] [Limited] [Full Access]

**No Access** prevents user access to the Setup utility.

**View Only** allows access but does not allow change to any field.

**Limited** allows changes only to selected fields, such as Date and Time.

**Full Access** allows viewing and changing all the fields in the Setup utility.

### **Change User Password**

Select this item to set or change the user password. The **User Password** item on top of the screen shows the default **Not Installed**. After you set a password, this item shows **Installed**.

To set a User Password:

1. Select the **Change User Password** item and press **<Enter>**.
2. On the password box, key in a password containing up to six letters, or numbers, or both, then press **<Enter>**.
3. Confirm the password when prompted.

The message "**Password Installed**" appears after you set your password successfully.

To change the user password, follow the same steps as in setting a user password.

### **Clear User Password**

Select this item to clear the user password.

### **Password Check [Setup]**

When set to **[Setup]**, BIOS checks for user password when accessing the Setup utility. When set to **[Always]**, BIOS checks for user password both when accessing Setup and booting the system. Configuration options: [Setup] [Always]

## 2.7 Tools menu

The **Tools** menu items allow you to configure options for special functions. Select an item then press **<Enter>** to display the sub-menu.

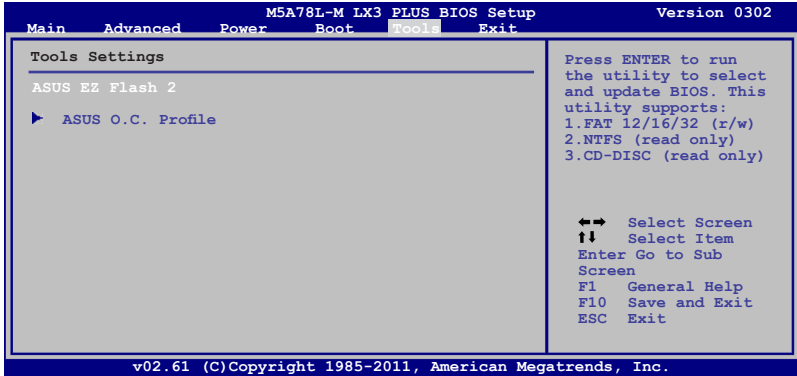

### 2.7.1 ASUS EZ Flash 2

Allows you to run ASUS EZ Flash 2. When you press **<Enter>**, a confirmation message appears. Use the left/right arrow key to select between **[Yes]** or **[No]**, then press **<Enter>** to confirm your choice. See section 2.1.2 for details.

### 2.7.2 ASUS O.C. Profile

This item allows you to store or load multiple BIOS settings.

#### Add Your CMOS Profile

Allows you to save the current BIOS file to the BIOS Flash. In the Name sub-item, key in your profile name and press **<Enter>**, and then choose a profile number to save your CMOS settings in the **Save to** sub-item.

#### Load CMOS Profiles.

Allows you to load the previous BIOS settings saved in the BIOS Flash. Press **<Enter>** to load the file.

#### Start O.C. Profile

Allows you to run the utility to save and load CMOS. Press **<Enter>** to run the utility.



- This function can support devices such as a USB flash disk with FAT 32/16 format and single partition only.
- DO NOT shut down or reset the system while updating the BIOS to prevent the system boot failure!
- We recommend that you update the BIOS file only coming from the same memory/CPU configuration and BIOS version.
- Only the CMO file can be loaded.

## 2.8 Exit menu

The **Exit** menu items allow you to load the optimal or failsafe default values for the BIOS items, and save or discard your changes to the BIOS items.

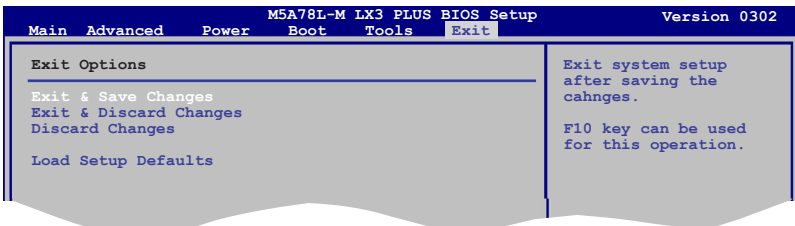

Pressing **<Esc>** does not immediately exit this menu. Select one of the options from this menu or **<F10>** from the legend bar to exit.

### Exit & Save Changes

Once you are finished making your selections, choose this option from the Exit menu to ensure the values you selected are saved to the CMOS RAM. An onboard backup battery sustains the CMOS RAM so it stays on even when the PC is turned off. When you select this option, a confirmation window appears. Select **OK** to save changes and exit.

### Exit & Discard Changes

Select this option only if you do not want to save the changes that you made to the Setup program. If you made changes to fields other than System Date, System Time, and Password, the BIOS asks for a confirmation before exiting.

### Discard Changes

This option allows you to discard the selections you made and restore the previously saved values. After selecting this option, a confirmation appears. Select **OK** to discard any changes and load the previously saved values.

### Load Setup Defaults

This option allows you to load the default values for each of the parameters on the Setup menus. When you select this option or if you press **<F5>**, a confirmation window appears. Select **OK** to load default values. Select **Exit & Save Changes** or make other changes before saving the values to the non-volatile RAM.



# Appendices

## Notices

### Federal Communications Commission Statement

This device complies with Part 15 of the FCC Rules. Operation is subject to the following two conditions:

- This device may not cause harmful interference.
- This device must accept any interference received including interference that may cause undesired operation.

This equipment has been tested and found to comply with the limits for a Class B digital device, pursuant to Part 15 of the FCC Rules. These limits are designed to provide reasonable protection against harmful interference in a residential installation. This equipment generates, uses and can radiate radio frequency energy and, if not installed and used in accordance with manufacturer's instructions, may cause harmful interference to radio communications. However, there is no guarantee that interference will not occur in a particular installation. If this equipment does cause harmful interference to radio or television reception, which can be determined by turning the equipment off and on, the user is encouraged to try to correct the interference by one or more of the following measures:

- Reorient or relocate the receiving antenna.
- Increase the separation between the equipment and receiver.
- Connect the equipment to an outlet on a circuit different from that to which the receiver is connected.
- Consult the dealer or an experienced radio/TV technician for help.



---

The use of shielded cables for connection of the monitor to the graphics card is required to assure compliance with FCC regulations. Changes or modifications to this unit not expressly approved by the party responsible for compliance could void the user's authority to operate this equipment.

---

### IC: Canadian Compliance Statement

Complies with the Canadian ICES-003 Class B specifications. This device complies with RSS 210 of Industry Canada. This Class B device meets all the requirements of the Canadian interference-causing equipment regulations.

This device complies with Industry Canada license exempt RSS standard(s). Operation is subject to the following two conditions: (1) this device may not cause interference, and (2) this device must accept any interference, including interference that may cause undesired operation of the device.

Cet appareil numérique de la Classe B est conforme à la norme NMB-003 du Canada. Cet appareil numérique de la Classe B respecte toutes les exigences du Règlement sur le matériel brouilleur du Canada.

Cet appareil est conforme aux normes CNR exemptes de licence d'Industrie Canada. Le fonctionnement est soumis aux deux conditions suivantes :

- (1) cet appareil ne doit pas provoquer d'interférences et
- (2) cet appareil doit accepter toute interférence, y compris celles susceptibles de provoquer un fonctionnement non souhaité de l'appareil.

## Canadian Department of Communications Statement

This digital apparatus does not exceed the Class B limits for radio noise emissions from digital apparatus set out in the Radio Interference Regulations of the Canadian Department of Communications.

This class B digital apparatus complies with Canadian ICES-003.

## VCCI: Japan Compliance Statement

### VCCI Class B Statement

情報処理装置等電波障害自主規制について

この装置は、情報処理装置等電波障害自主規制協議会（VCCI）の基準に基づくクラスB情報技術装置です。この装置は家庭環境で使用されることを目的としていますが、この装置がラジオやテレビジョン受信機に近接して使用されると、受信障害を引き起こすことがあります。

取扱説明書に従って正しい取り扱いをして下さい。

## KC: Korea Warning Statement

B급 기기 (가정용 방송통신기자재)

이 기기는 가정용(B급) 전자파적합기기로서 주로 가정에서 사용하는 것을 목적으로 하며, 모든 지역에서 사용할 수 있습니다.

\*당해 무선설비는 전파혼신 가능성이 있으므로 인명안전과 관련된 서비스는 할 수 없습니다.

## REACH

Complying with the REACH (Registration, Evaluation, Authorisation, and Restriction of Chemicals) regulatory framework, we published the chemical substances in our products at ASUS REACH website at <http://csr.asus.com/english/REACH.htm>.



DO NOT throw the motherboard in municipal waste. This product has been designed to enable proper reuse of parts and recycling. This symbol of the crossed out wheeled bin indicates that the product (electrical and electronic equipment) should not be placed in municipal waste. Check local regulations for disposal of electronic products.



DO NOT throw the mercury-containing button cell battery in municipal waste. This symbol of the crossed out wheeled bin indicates that the battery should not be placed in municipal waste.

## ASUS Recycling/Takeback Services

ASUS recycling and takeback programs come from our commitment to the highest standards for protecting our environment. We believe in providing solutions for you to be able to responsibly recycle our products, batteries, other components as well as the packaging materials. Please go to <http://csr.asus.com/english/Takeback.htm> for detailed recycling information in different regions.

## ASUS contact information

### ASUSTeK COMPUTER INC.

Address 15 Li-Te Road, Peitou, Taipei, Taiwan 11259  
Telephone +886-2-2894-3447  
Fax +886-2-2890-7798  
E-mail info@asus.com.tw  
Web site www.asus.com.tw

#### *Technical Support*

Telephone +86-21-38429911  
Online support support.asus.com

### ASUS COMPUTER INTERNATIONAL (America)

Address 800 Corporate Way, Fremont, CA 94539, USA  
Telephone +1-812-282-3777  
Fax +1-510-608-4555  
Web site usa.asus.com

#### *Technical Support*

Telephone +1-812-282-2787  
Support fax +1-812-284-0883  
Online support support.asus.com

### ASUS COMPUTER GmbH (Germany and Austria)

Address Harkort Str. 21-23, D-40880 Ratingen, Germany  
Fax +49-2102-959911  
Web site www.asus.de  
Online contact www.asus.de/sales

#### *Technical Support*

Telephone +49-1805-010923\*  
Support Fax +49-2102-9599-11  
Online support support.asus.com

\* EUR 0.14/minute from a German fixed landline; EUR 0.42/minute from a mobile phone.

# DECLARATION OF CONFORMITY

Per FCC Part 2 Section 2.1077(a)



Responsible Party Name: **Asus Computer International**

Address: **800 Corporate Way, Fremont, CA 94539.**

Phone/Fax No: **(510)739-3777/(510)608-4555**

hereby declares that the product

**Product Name : Motherboard**

**Model Number : M5A78L-M LX3**

Conforms to the following specifications:

- FCC Part 15, Subpart B, Unintentional Radiators
- FCC Part 15, Subpart C, Intentional Radiators
- FCC Part 15, Subpart E, Intentional Radiators

### Supplementary Information:

This device complies with part 15 of the FCC Rules. Operation is subject to the following two conditions: (1) This device may not cause harmful interference, and (2) this device must accept any interference received, including interference that may cause undesired operation.

Representative Person's Name : Steve Chang / President

Signature : *Steve Chang*  
Date : Jan. 12, 2012

Ver. 110/01

# EC Declaration of Conformity



We, the undersigned,

Manufacturer: **ASUSTEK COMPUTER INC.**  
Address, City: **#F, No. 150, LI-TE RGL, PEITOU, TAIPEI 112, TAIWAN**  
Country: **TAIWAN**  
Authorized representative in Europe: **ASUS COMPUTER GmbH**  
Address, City: **HARKORT STR. 21-23, 40880 RATINGEN**  
Country: **GERMANY**

declare the following apparatus:

Product name : **Motherboard**  
Model name : **M5A78L-M LX3, M5A78L-M LX3 PLUS**

conform with the essential requirements of the following directives:

- 2004/108/EC-EMC Directive**
- EN 55022:2010
- EN 61000-3-2/09+A2:2009
- EN 61000-3-3:2008
- EN 55022:2007/AT1:2011
- 1989/EEC-R&TTE Directive**
- EN 300 328:2002
- EN 300 440-1 V1.6 (12010-08)
- EN 300 440-2 V1.4 (12010-08)
- EN 300 440-3 V1.2 (12010-08)
- EN 301 908-1 V0.5.2 (12011-09)
- EN 301 908-2 V0.5.2 (12011-07)
- EN 301 908-3 V1.1 (12008-01)
- EN 302 842 V1.1 (12008-01)
- EN 302 623 V1.1 (12009-01)
- EN 300 335-1 V1.7 (12010-02)
- EN 300 335-2 V1.5 (12010-02)
- EN 50 360:2001
- EN 62479:2010
- EN 301 663 V1.9 (2011-09)
- EN 301 489-3 V1.4 (2012-08)
- EN 301 489-4 V1.4 (12009-05)
- EN 301 489-5 V1.4 (12009-05)
- EN 301 489-6 V1.4 (12007-11)
- EN 301 489-7 V1.4 (12007-11)
- EN 301 489-8 V2.1 (12009-05)
- EN 301 489-9 V2.1 (12009-05)
- EN 302 583-3 V1.2 (2007-08)
- EN 302 583-3 V1.3 (2007-08)
- EN 301 357-2 V1.4 (12008-11)
- EN 62311:2008

### 2006/95/EC-LVD Directive

- EN 60065:2002 / A2:2010
- EN 60950-1/A12:2011
- EN 60065:2002 / A12:2011

### 2009/128/EC-EP Directive

- Regulation (EC) No. 1275/2008
- Regulation (EC) No. 642/2009

### 2011/65/EU-RoHS Directive

- Regulation (EC) No. 2762/2009

### CE marking



(EC conformity marking)

Position : **CEO**  
Name : **Jerry Shen**

Signature : *Jerry Shen*

Declaration Date: **Dec. 10, 2012**  
Year to begin affixing CE marking: **2012**

Signature : \_\_\_\_\_



**DECLARATION OF CONFORMITY**

Per FCC Part 2 Section 2.1077(e)



**Responsible Party Name:** Asus Computer International

**Address:** 800 Corporate Way, Fremont, CA 94539.

**Phone/Fax No:** (510)739-3777/(510)608-4555

hereby declares that the product

**Product Name :** Motherboard

**Model Number :** M5A78L-M LX3 PLUS

Conforms to the following specifications:

FCC Part 15, Subpart B, Unintentional Radiators

**Supplementary Information:**

This device complies with part 15 of the FCC Rules. Operation is subject to the following two conditions: (1) This device may not cause harmful interference, and (2) this device must accept any interference received, including interference that may cause undesired operation.

Representative Person's Name: Steve Chang / President

Signature :

A handwritten signature in blue ink that reads "Steve Chang". The signature is written in a cursive style.

Date : Jun. 29, 2012

## Free Manuals Download Website

<http://myh66.com>

<http://usermanuals.us>

<http://www.somanuals.com>

<http://www.4manuals.cc>

<http://www.manual-lib.com>

<http://www.404manual.com>

<http://www.luxmanual.com>

<http://aubethermostatmanual.com>

Golf course search by state

<http://golfingnear.com>

Email search by domain

<http://emailbydomain.com>

Auto manuals search

<http://auto.somanuals.com>

TV manuals search

<http://tv.somanuals.com>