

User Guide

RT-N10P

Superspeed Wireless N Router

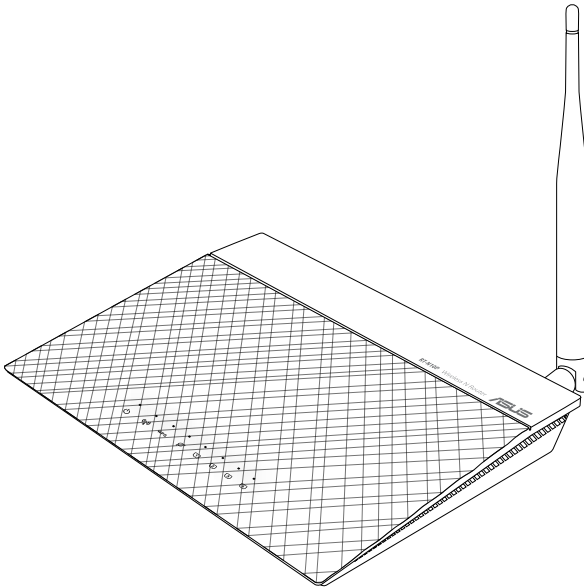

ASUS[®]
Inspiring Innovation • Persistent Perfection

E8145

First Edition

February 2013

Copyright © 2013 ASUSTeK Computer Inc. All Rights Reserved.

No part of this manual, including the products and software described in it, may be reproduced, transmitted, transcribed, stored in a retrieval system, or translated into any language in any form or by any means, except documentation kept by the purchaser for backup purposes, without the express written permission of ASUSTeK Computer Inc. ("ASUS").

Product warranty or service will not be extended if: (1) the product is repaired, modified or altered, unless such repair, modification or alteration is authorized in writing by ASUS; or (2) the serial number of the product is defaced or missing.

ASUS PROVIDES THIS MANUAL "AS IS" WITHOUT WARRANTY OF ANY KIND, EITHER EXPRESS OR IMPLIED, INCLUDING BUT NOT LIMITED TO THE IMPLIED WARRANTIES OR CONDITIONS OF MERCHANTABILITY OR FITNESS FOR A PARTICULAR PURPOSE. IN NO EVENT SHALL ASUS, ITS DIRECTORS, OFFICERS, EMPLOYEES OR AGENTS BE LIABLE FOR ANY INDIRECT, SPECIAL, INCIDENTAL, OR CONSEQUENTIAL DAMAGES (INCLUDING DAMAGES FOR LOSS OF PROFITS, LOSS OF BUSINESS, LOSS OF USE OR DATA, INTERRUPTION OF BUSINESS AND THE LIKE), EVEN IF ASUS HAS BEEN ADVISED OF THE POSSIBILITY OF SUCH DAMAGES ARISING FROM ANY DEFECT OR ERROR IN THIS MANUAL OR PRODUCT.

SPECIFICATIONS AND INFORMATION CONTAINED IN THIS MANUAL ARE FURNISHED FOR INFORMATIONAL USE ONLY, AND ARE SUBJECT TO CHANGE AT ANY TIME WITHOUT NOTICE, AND SHOULD NOT BE CONSTRUED AS A COMMITMENT BY ASUS. ASUS ASSUMES NO RESPONSIBILITY OR LIABILITY FOR ANY ERRORS OR INACCURACIES THAT MAY APPEAR IN THIS MANUAL, INCLUDING THE PRODUCTS AND SOFTWARE DESCRIBED IN IT.

Products and corporate names appearing in this manual may or may not be registered trademarks or copyrights of their respective companies, and are used only for identification or explanation and to the owners' benefit, without intent to infringe.

Table of contents

1 Overview	5
Package contents	5
Hardware features	6
2 Setting up your wireless network	9
Positioning your router.....	9
What you need	10
Setting up your wireless router	10
Wired connection.....	11
Wireless connection	12
Before you proceed	13
A. Disable any configured proxy servers.....	13
B. Configure TCP/IP settings.....	15
C. Disable dial-up networking	18
3 Network configuration using the web GUI	19
Logging in to the web GUI	19
Setting up the Internet connection	20
Quick Internet Setup (QIS) with auto-detection	21
Setting up wireless security	26
Creating your Guest Network	28
Using the Traffic Manager.....	30
Managing QoS (Quality of Service) Bandwidth.....	30
Monitoring Traffic	32
Configuring Advanced settings.....	33
Setting up the DHCP Server	33
Upgrading the firmware	35
Restoring/Saving/Uploading settings	36

Table of contents

4	Using the utilities	37
	Device Discovery	37
	Firmware Restoration	39
5	Troubleshooting	41
	Troubleshooting	41
	ASUS DDNS Service	45
	Frequently Asked Questions (FAQs)	45
	Appendices	47
	Notices.....	47
	Networks Global Hotline Information.....	61
	ASUS Contact information	64

1 Overview

Package contents

- RT-N10P wireless router
- Network cable (RJ-45)
- Power adapter
- Quick Start Guide
- Warranty card





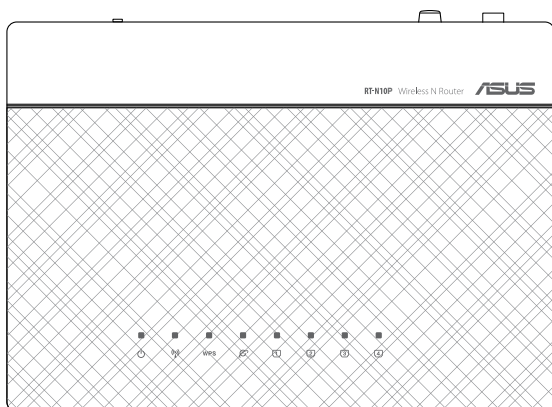

-
- If any of the items is damaged or missing, contact ASUS for technical inquiries and support. Refer to the ASUS Support Hotline list at the back of this user manual.
 - Keep the original packaging material in case you would need future warranty services such as repair or replacement.
-

Hardware features

Front





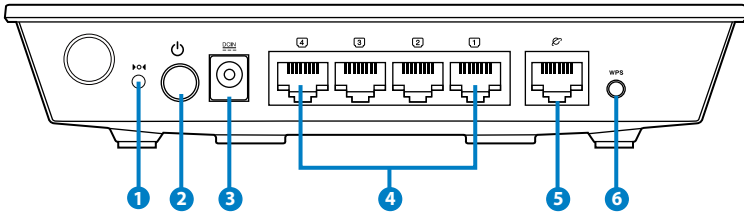

Status indicators

LED	Status	Indication
 Power	Off	No power
	On	System ready
	Flashing slowly	Rescue mode
 Wireless	Off	No power
	On	Wireless system ready
	Flashing	Transmitting or receiving data (wireless)
WPS	Flashing	WPS in progress
 WAN Wide Area Network	Off	No power or no physical connection
	On	Has physical connection to an Ethernet network
	Flashing	Transmitting or receiving data (through Ethernet cable)
 LAN 1-4 Local Area Network	Off	No power or no physical connection
	On	Has physical connection to an Ethernet network
	Flashing	Transmitting or receiving data (through Ethernet cable)

Rear



Label	Description
1  Reset	Press this button for more than five seconds to restore the system to its factory default settings.
2  Power	Press this button to power on/off the wireless router.
3 DCIN	Insert the AC adapter into this port to connect your router to a power source.
4  LAN1-LAN4	Connect RJ-45 Ethernet cables to these ports to establish LAN connection.
5  WAN	Connect an RJ-45 Ethernet cable to this port to establish WAN connection.
6 WPS	Press this button for more than four seconds to establish a secure wireless connection with a WPS-supported wireless device.

Bottom panel

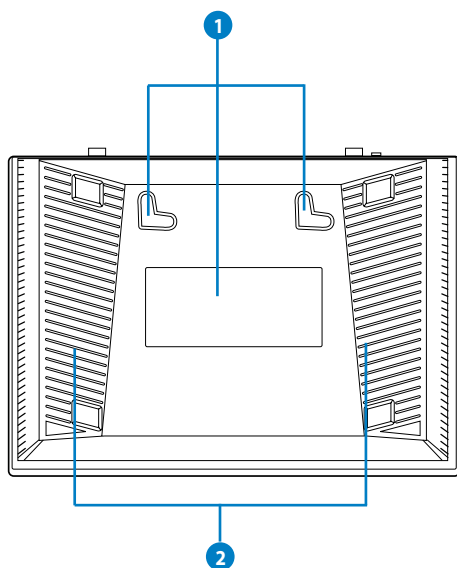

Item	Description
1	Mounting hooks Use the mounting hooks to mount your router on concrete or wooden surfaces using two round head screws.
2	Air vents These vents provide ventilation to your router.



Mounting the wireless router to a wall is not recommended as it reduces wireless performance.

2 Setting up your wireless network

Positioning your router

To get the best wireless network performance from your wireless router, follow the recommendations below:

- Place the wireless router at the center of your network for maximum wireless coverage.
- Keep the device away from metal obstructions and away from direct sunlight.
- Keep the device away from 802.11g or 20MHz only Wi-Fi devices, 2.4GHz computer peripherals, Bluetooth devices, cordless phones, transformers, heavy-duty motors, fluorescent lights, microwave ovens, refrigerators, and other industrial equipment to prevent signal interference or loss.
- For the best front-to-rear wireless coverage, place the wireless router in an upright position.
- For the best upward and downward wireless coverage, place the wireless router in an inclined position.
- Always update to the latest firmware. Visit the ASUS website at <http://support.asus.com> to get the latest firmware updates.

What you need

To set up your network, you need one or two computers that meet the following system requirements:

- Ethernet RJ-45 (LAN) port (10Base-T/100Base-TX)
- IEEE 802.11b/g/n wireless capability
- An installed TCP/IP service
- Web browser such as Microsoft Internet Explorer, Mozilla Firefox, Apple Safari, or Google Chrome



-
- If your computer does not have built-in wireless capabilities, install an IEEE 802.11b/g/n WLAN adapter to your computer to connect to the network.
 - The Ethernet RJ-45 cables used to connect the network devices should not exceed 100 meters.
-

Setting up your wireless router



-
- Use a wired connection when setting up your wireless router to avoid possible wireless setup issues.
 - Before setting up your ASUS wireless router, do the following:
 - If you are replacing an existing router, disconnect it from your network.
 - Disconnect the cables/wires from your existing modem. If your modem has a backup battery, remove it as well.
 - Reboot your computer (recommended).
-

Wired connection



Your wireless router supports both a straight-through or crossover cable when setting up a wired connection.

To set up a network using a wired connection:

1. Insert your wireless router's AC adapter to the DC-In port and plug it to a power outlet.
2. Using the bundled network cable, connect your computer to your wireless router's LAN port.

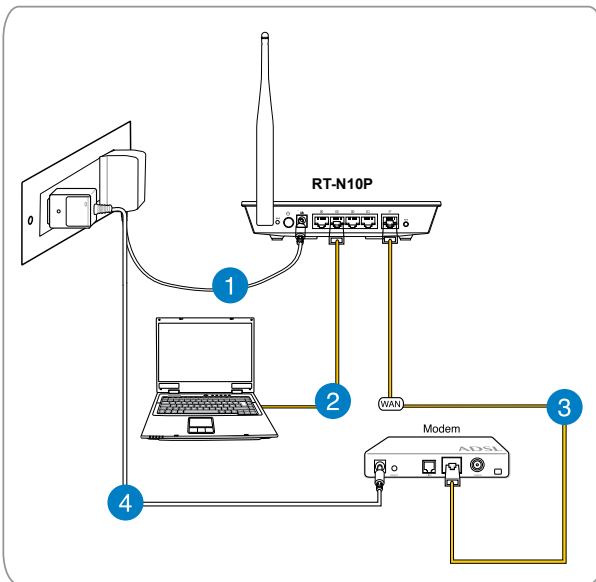

Ensure that the LAN LED is blinking.

3. Using another network cable, connect your modem to your wireless router's WAN port.
4. Insert your modem's AC adapter to the DC-In port and plug it to a power outlet.

Wireless connection

To set up your wireless network:

1. Insert your wireless router's AC adapter to the DC-In port and plug it to a power outlet.
2. Using the bundled network cable, connect your modem to your wireless router's WAN port.
3. Insert your modem's AC adapter to the DC-In port and plug it to a power outlet.
4. Install an IEEE 802.11b/g/n WLAN adapter on your computer.



- For details on connecting to a wireless network, refer to the WLAN adapter's user manual.
- To set up the security settings for your network, refer to the section **Setting up wireless security**.

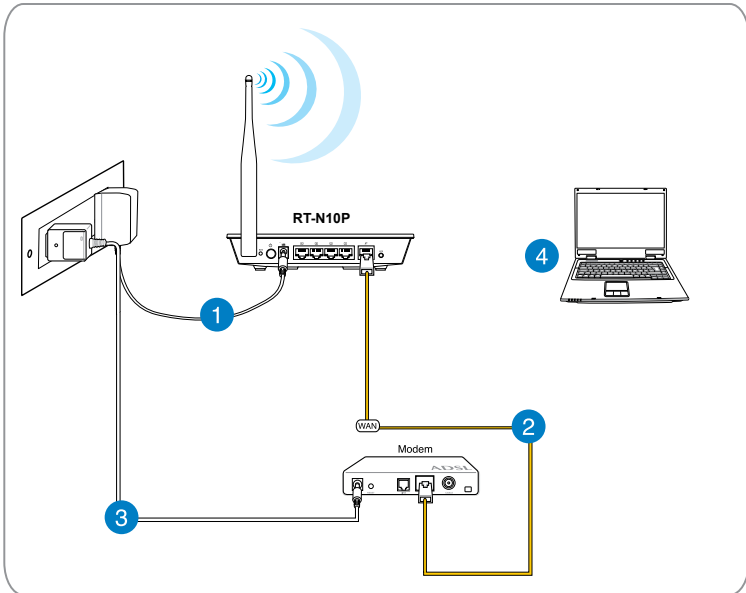

Before you proceed



Before configuring your wireless router, apply the steps described in this section to each computer on the network to avoid problems connecting to the wireless network.

A. Disable any configured proxy servers.

Windows® 7

1. Click **Start > Internet Explorer**.
2. Click **Tools > Internet options > Connections tab > LAN settings**.

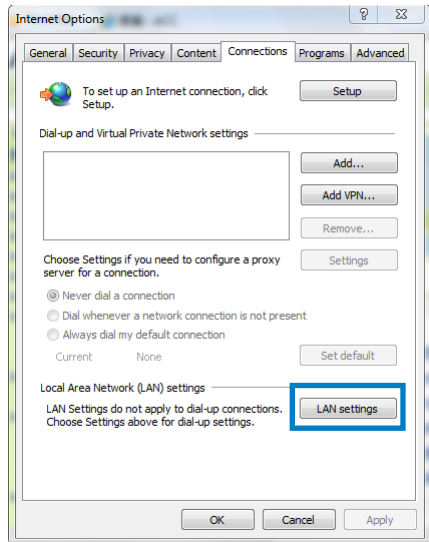

- From the Local Area Network (LAN) Settings window, uncheck **Use a proxy server for your LAN**.
- Click **OK** then **Apply**.

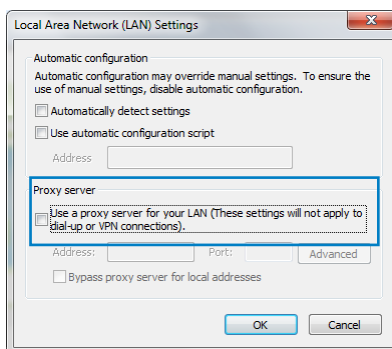

MAC OSX

- From your **Apple Safari** browser, click **Safari > Preferences > Advanced**. On the **Proxies** item, click **Change Settings...**

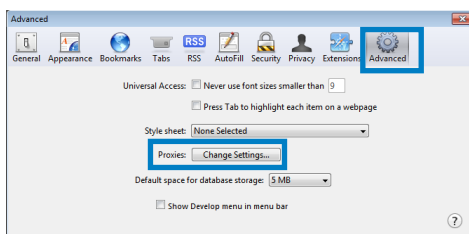

- From the **Network** screen, uncheck **FTP Proxy** and **Web Proxy (HTTP)**.
- Click **OK** then **Apply**.

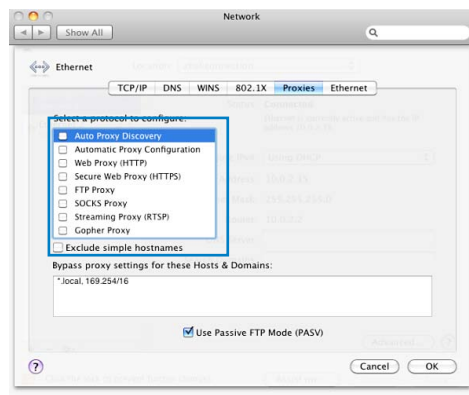

B. Configure TCP/IP settings to automatically obtain an IP address.

Windows® 7

1. Click **Start > Control Panel > Network and Internet > Network and Sharing Center > Change adapter settings.**
2. On the Network Connections window, click on **Local Area Connection.**
3. On the Local Area Connection Network Status window, click **Properties.**
4. Select Internet Protocol Version 4 (TCP/IPv4) or Internet Protocol Version 6 (TCP/IPv6), then click **Properties.**

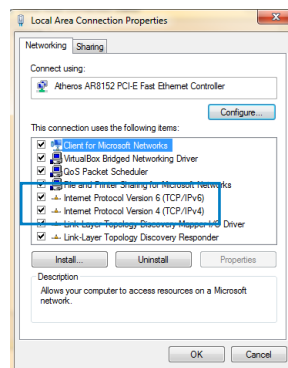
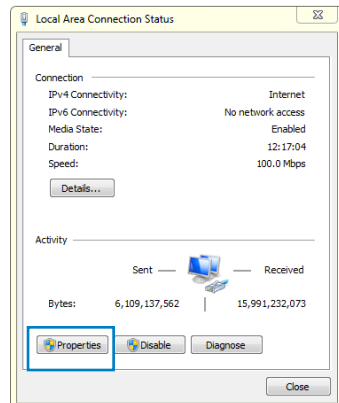
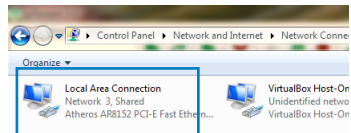
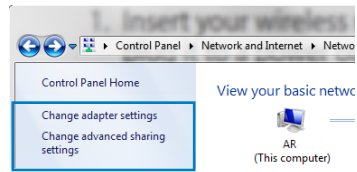

6. Tick **Obtain an IP address automatically.**

7. Click **OK.**

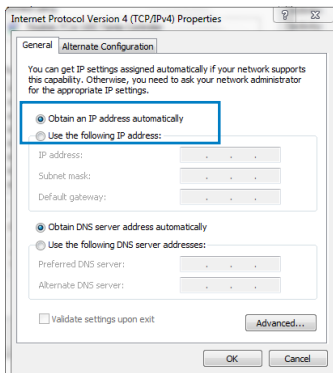

MAC OS X

1. Click **Apple Menu**
>**System Preferences** >
Network



2. Click **Ethernet** on the left panel.
3. On the Configure IPv4, item select **Using DHCP**.
4. Click **Apply**.

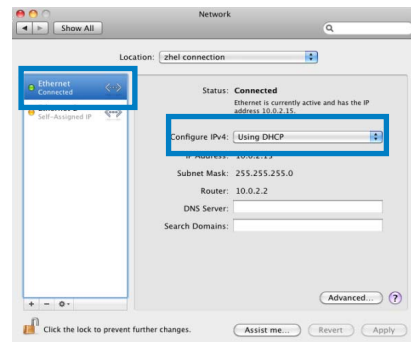

C. Disable dial-up networking

Windows® 7

1. Click **Start > Internet Explorer**.
2. Click **Tools > Internet Options > Connections** tab.
3. Tick **Never dial a connection**.
4. Click **Apply** then **OK**.

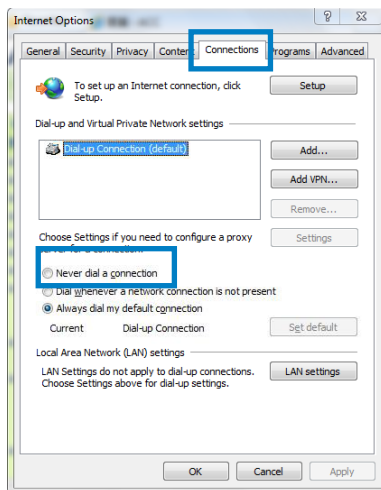

3 Network configuration using the web GUI

Logging in to the web GUI

Your ASUS Wireless Router uses a web-based user interface that allows you to configure the router using any web browser such as Internet Explorer, Mozilla Firefox, Apple Safari, or Google Chrome.

To log in to the web GUI:

1. Launch your web browser and manually key in the wireless router's default IP address: **192.168.1.1**
2. On the login page, key in the default user name (**admin**) and password (**admin**).

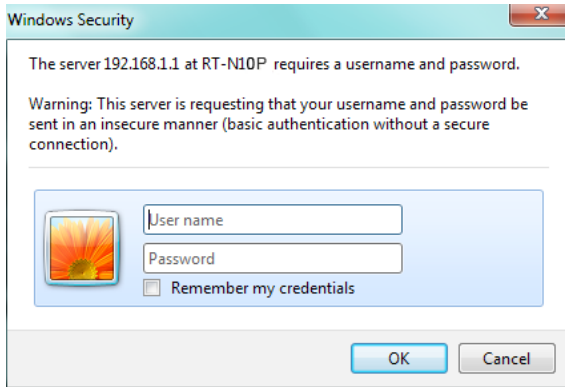

3. The wireless router GUI provides access to various configuration settings.

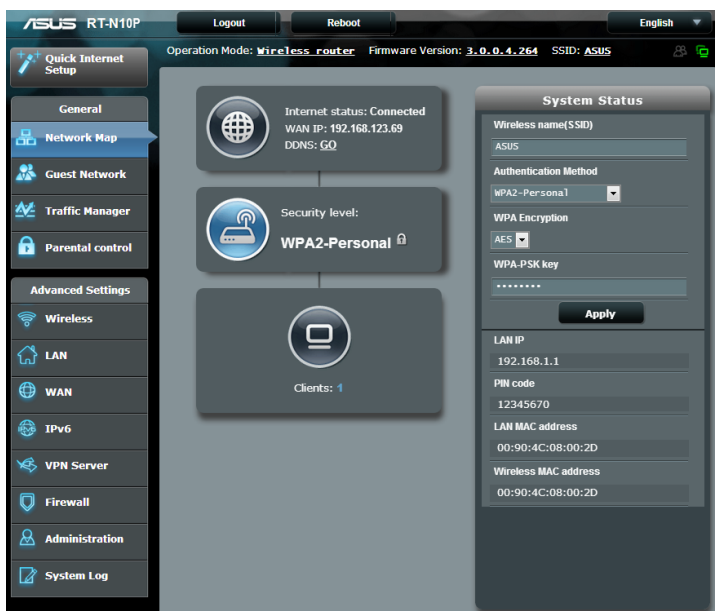

Setting up the Internet connection



When setting up the Internet connection for the first time, press the Reset button on your wireless router to reset it to its factory default settings.

Quick Internet Setup (QIS) with auto-detection

The Quick Internet Setup (QIS) feature guides you in quickly setting up your Internet connection.

To use QIS with auto-detection:

1. Launch a web browser such as Internet Explorer, Mozilla Firefox, Apple Safari, or Google Chrome.
2. Quick Internet Setup will launch automatically. Click **Next**.

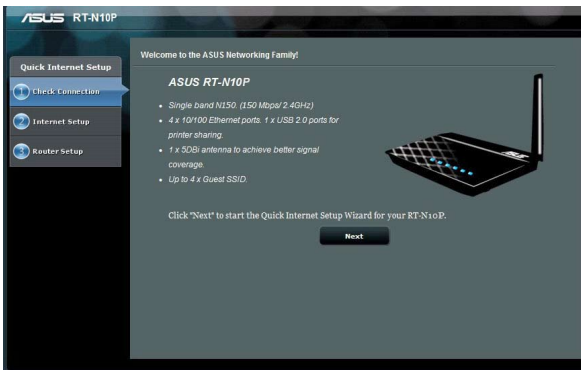

- If QIS failed to launch automatically, manually launch your wireless router's web GUI to access the QIS page. To do this, follow these steps:
 1. On your web browser, key in **<http://192.168.1.1>**
 2. On the login page, key in the default username **admin** and password **admin**.
 3. Click **Quick Internet Setup** on the navigation panel.

3. Key in a new administrator password to prevent unauthorized access to the router. Click **Next**.

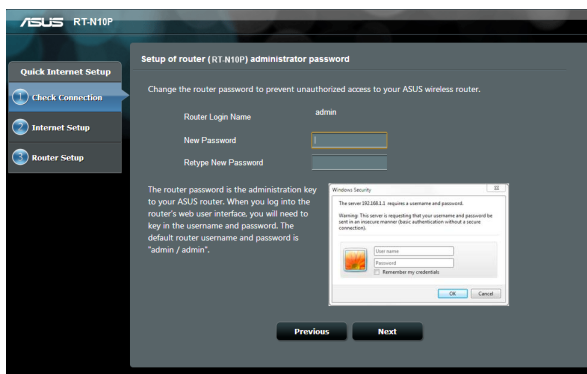

4. Select Wireless router mode, Repeater mode, or Access Point (AP) mode. Click **Next**.



To set up a wireless network with Internet access, use **Wireless router mode**.

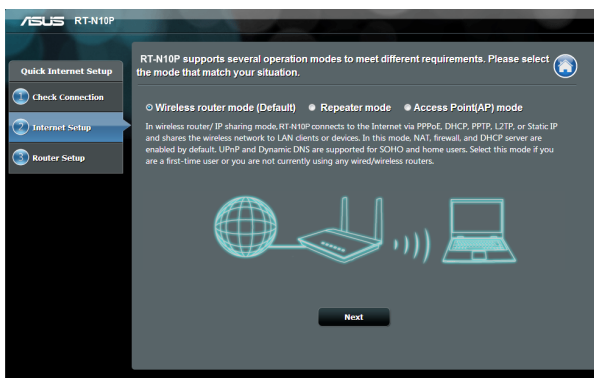

5. The wireless router will attempt to identify your connection type. If needed, select the necessary connection type and key in any necessary information required, such as your ISP user name and password.

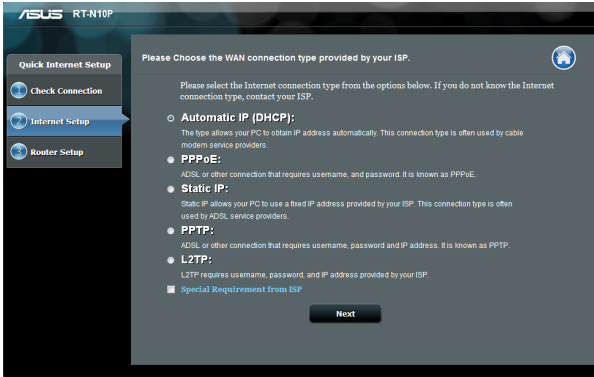

Obtain the necessary information about your Internet connection type and additional login information from your Internet Service Provider.



- Auto-detection of your ISP connection type takes place when you configure the wireless router for the first time or when your wireless router is reset to its default settings.
 - If QIS failed to detect your Internet connection type, click **Skip to manual setting** and manually configure your connection settings.
-

6. In the Wireless setting screen, key in a **network name (SSID)** and assign a security key for your wireless connection. Click **Apply**.

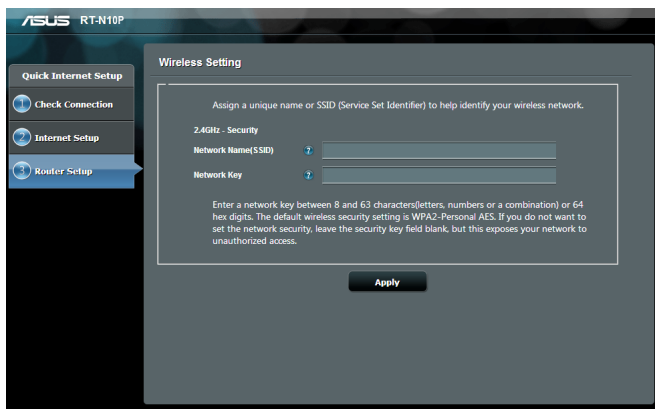

7. A summary of your network settings will be displayed. Click **Next** to continue.

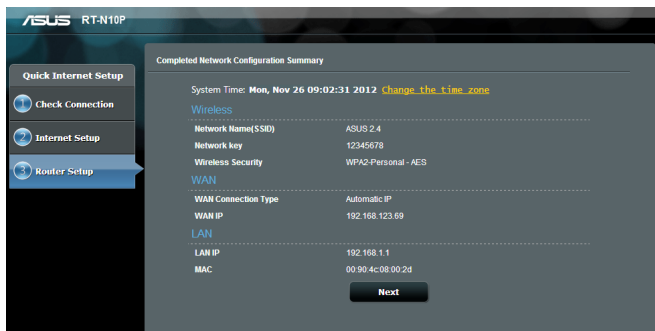

8. Read the **Wireless Network Connection Tutorial**. Click **Finish**.

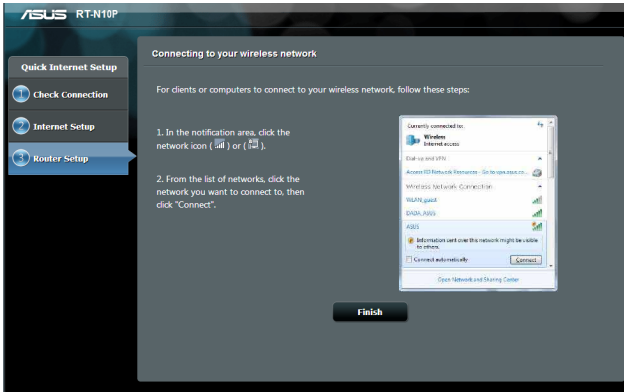

Setting up wireless security

To protect your wireless network from unauthorized access, you need to configure your router's security settings.

To set up the wireless security settings:

1. Key in **192.168.1.1** on your web browser.
2. On the login screen, key in the default user name (**admin**) and password (**admin**), then click **OK**. The wireless router's web GUI launches.
3. On the Network Map screen, the **System Status** area displays the SSID (Service Set Identifier), Authentication Method, and security key settings of your wireless network.

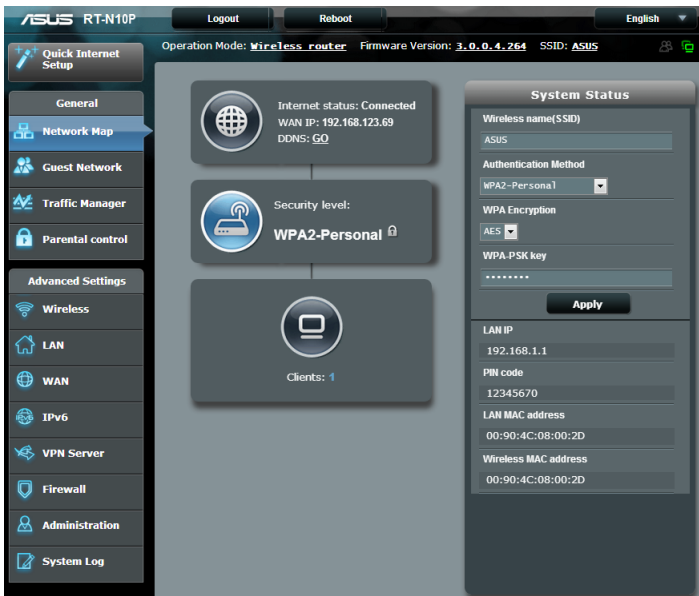

4. On the **Wireless name (SSID)** field, key in a unique name for your wireless network.
5. From the **Authentication Method** dropdown list, select the encryption method for your wireless network.



The IEEE 802.11n standard prohibits using High Throughput with WEP or WPA-TKIP as the unicast cipher. If you use these encryption methods, your data rate will drop to IEEE 802.11g 54Mbps connection.

6. Key in your security passkey.
7. Click **Apply**.

Creating your Guest Network

Setting up a Guest Network provides wireless Internet connectivity for temporary visitors while restricting access to your private network.

To create your guest network:

1. Click **Guest Network** on the navigation panel.
2. Click **Enable**.

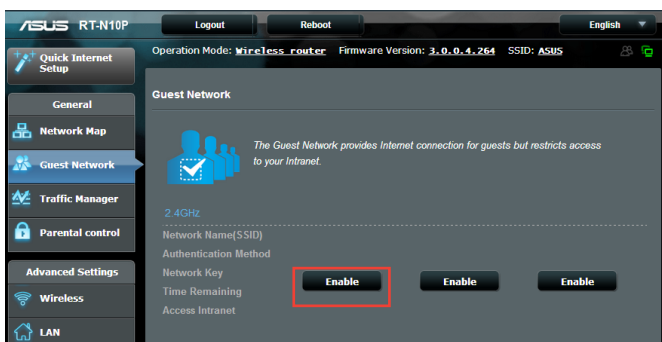

3. To configure additional options, click any of the items listed.



4. Assign a wireless name for your temporary network on the **Network Name (SSID)** field.
5. Select an **Authentication Method**.
6. Select a **WEP Encryption** method.
7. Specify the **Access time** or click **Limitless**.
8. Select Disable or Enable on the **Access Intranet** item.
9. Click **Apply**.

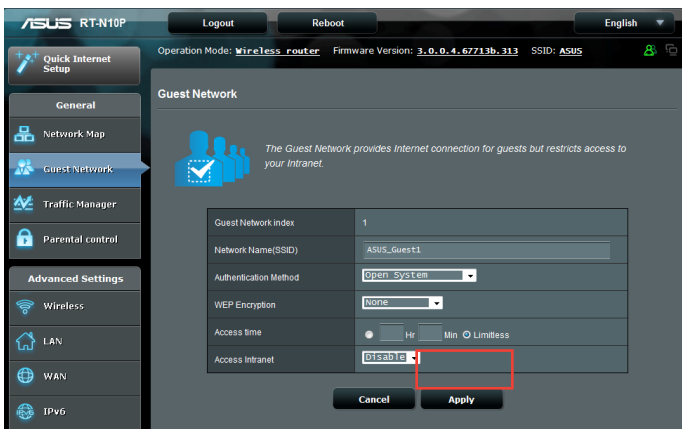

Using the Traffic Manager

Managing QoS (Quality of Service) Bandwidth

The **Quality of Service** feature allows you to set the bandwidth priority and manage network traffic.

To set up QoS:

1. Click **Traffic Manager** on the navigation panel and click the **QoS** tab.
2. Click **ON** to enable QoS.
3. Click **Save**.

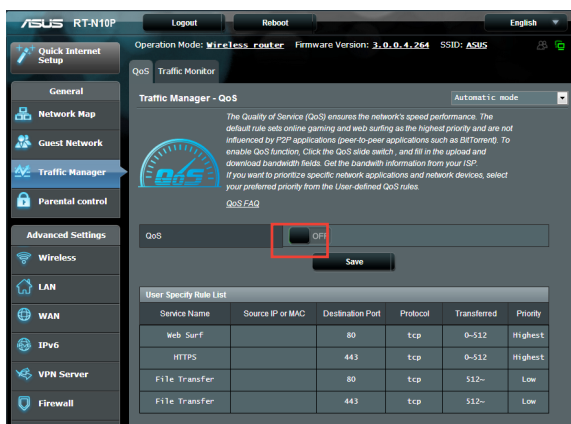

Your bandwidth information is available from your ISP.

- If you want to prioritize specific network applications and network services, click **User-defined Priority** on the upper-right hand corner.
- Adjust the values as needed. Click **Apply**.

Operation Mode: **Wireless router** Firmware Version: **3.0.0.4.264** SSID: **ASUS**

QoS Traffic Monitor

Traffic Manager - QoS User-defined Priority

From the User-defined QoS rules dropdown list, you can prioritize the network applications or devices into five levels. Based on priority level, QoS uses the following methods in sending data packets:

- Change the order of upstream network packets, which refer to the order in which packets are sent to the Internet.
- Low-priority packets are disregarded to ensure the transmission of high-priority packets. The higher priority upstream packet will cause the higher priority downstream packet.
- If there are no packets being sent from high-priority applications, the full transmission rate of the Internet connection is available for low-priority packets.
- Enable QoS then set up the upload and download rate limits.

Set up the Upload and Download rate limits

Upload Bandwidth				Download Bandwidth		
Upload Priority	Minimum Reserved Bandwidth	Maximum Bandwidth Limit	Current Settings	Download Priority	Maximum Bandwidth Limit	Current Settings
Highest	80 %	100 %	0 ~ 0 Kbps	Highest	100 %	0 ~ 0 Kbps
High	10 %	100 %	0 ~ 0 Kbps	High	100 %	0 ~ 0 Kbps
Medium	5 %	100 %	0 ~ 0 Kbps	Medium	100 %	0 ~ 0 Kbps
Low	3 %	100 %	0 ~ 0 Kbps	Low	100 %	0 ~ 0 Kbps
Lowest	2 %	95 %	0 ~ 0 Kbps	Lowest	100 %	0 ~ 0 Kbps

The Highest Priority packet

The default ACK, SYN and ICMP packets are used to improve the game smoothness.

ACK
 SYN
 FIN
 RST
 ICMP

Apply

Monitoring Traffic

Click the **Traffic Monitor** tab to view real-time or historical bandwidth information of your Internet, Wired, and Wireless connections.

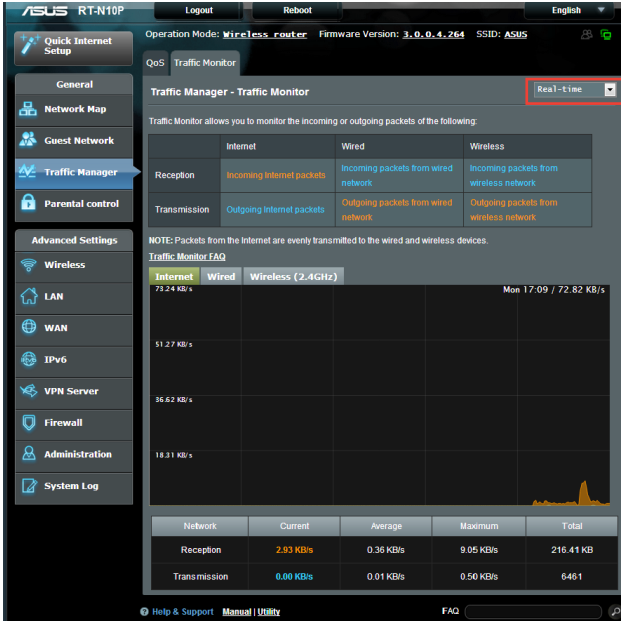

Configuring Advanced settings

Setting up the DHCP Server

Your wireless router uses DHCP to assign IP addresses automatically on your network. You can specify the IP address range and lease time for the clients on your network.

To configure the DHCP server:

1. Click **LAN** on the navigation panel.
2. Click the **DHCP Server** tab.

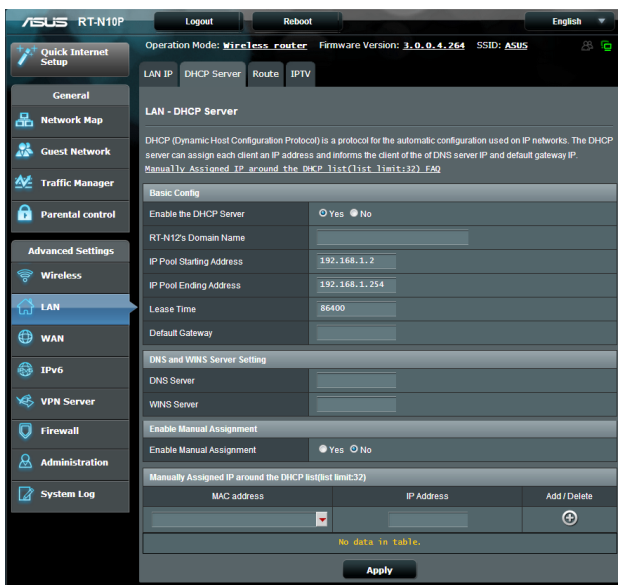

3. In the **Enable the DHCP Server** field, tick **Yes**.
4. In the **IP Pool Starting Address** field, key in the starting IP address.
5. In the **IP Pool Ending Address** field, key in the ending IP address.

6. In the **Lease Time** field, specify in seconds when an assigned IP address will expire. Once it reaches this time limit, the DHCP server will then assign a new IP address.



-
- ASUS recommends that you use an IP address format of 192.168.1.xxx (where xxx can be any number between 2 and 254) when specifying an IP address range.
 - An IP Pool Starting Address should not be greater than the IP Pool Ending Address.
-

Upgrading the firmware



Download the latest firmware from the ASUS website at <http://support.asus.com>

To upgrade the firmware:

1. Click **Administration** from the navigation panel.
2. Click the **Firmware Upgrade** tab.
3. In the **New Firmware File** item, click **Browse**. Navigate to the downloaded firmware file.
4. Click **Upload**.

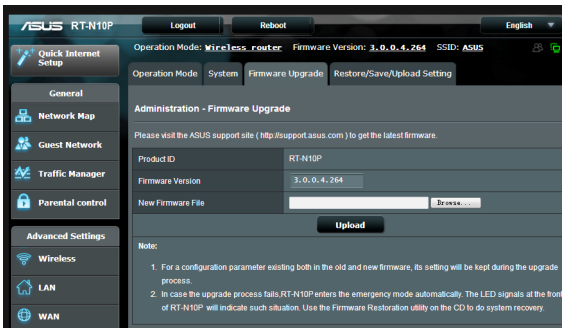

If the upgrade process fails, the wireless router automatically enters rescue mode and the power LED indicator on the front panel starts flashing slowly. To recover or restore the system, use the Firmware Restoration utility.

Restoring/Saving/Uploading settings

To restore/save/upload wireless router settings:

1. Click **Administration** on the navigation panel.
2. Click the **Restore/Save/Upload Setting** tab.

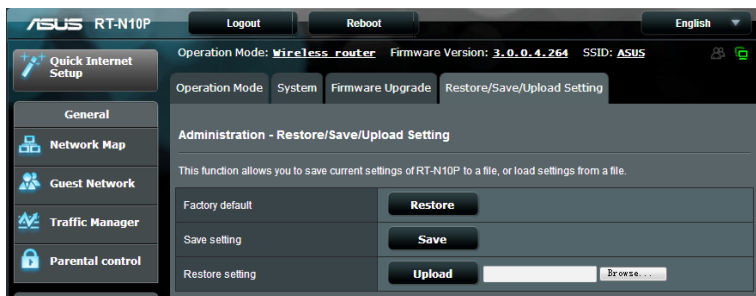

3. Select a task from the configuration options:
 - To restore to default factory settings, click **Restore**, and click **OK** once prompted.
 - To save the current system settings, click **Save**, navigate to the folder where you intend to save the file and click **Save**.
 - To restore from a saved system settings file, click **Browse** to locate your file, then click **Upload**.

4 Using the utilities



ASUS wireless router utilities can be downloaded from <http://support.asus.com>

After downloading and installing the setup file for the ASUS wireless utilities, the Device Discovery and Firmware Restoration utilities will be added to your applications.

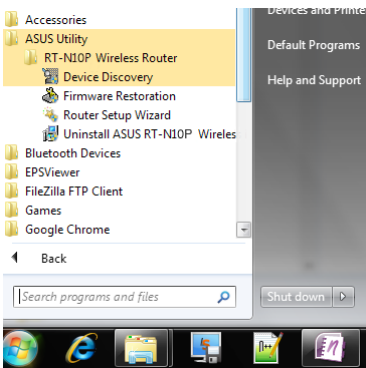

Device Discovery

Device Discovery is an ASUS WLAN utility that detects any ASUS wireless routers available on the wireless network and allows you to configure the device.

To launch the Device Discovery utility:

- Click **Start > All Programs > ASUS Utility > RT-N10P Wireless Router > Device Discovery.**



When you set the router to Access Point mode, you need to use Device Discovery to get the router's IP address.

Firmware Restoration

Firmware Restoration is used on an ASUS Wireless Router after a failed firmware upgrade. This utility uploads a firmware file to the wireless router. The process takes about three to four minutes.



Launch rescue mode before using the Firmware Restoration utility.

To launch rescue mode and use the Firmware Restoration utility:

1. Unplug the wireless router from its power source.
2. While holding down the Reset button at the back of the wireless router, plug the wireless router into a power source. Release the Reset button when the Power LED at the front panel begins to flash slowly, which indicates that the wireless router is in rescue mode.
3. Use the following to set up your TCP/IP settings:

IP address: 192.168.1.x

Subnet mask: 255.255.255.0

4. From your computer's desktop, click **Start > All Programs > ASUS Utility > RT-N10P Wireless Router > Firmware Restoration.**

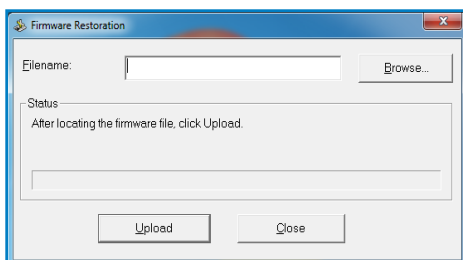

5. Click **Browse** to navigate to the firmware file, then click **Upload**.



The Firmware Restoration utility is not used to upgrade the firmware of a working ASUS Wireless Router. Normal firmware upgrades must be done through the web GUI. Refer to **Upgrading the firmware** for more details.

5 Troubleshooting



If you encounter problems that are not mentioned in this chapter, contact ASUS Technical Support.

Troubleshooting

I cannot access the router GUI for configuring the router.

- Delete the cookies and temporary files in your web browser. To do this in Internet Explorer 8:
 1. Launch your web browser, then click **Tools > Internet Options**.
 2. On the General tab, click **Delete** under Browsing history.
 3. Tick **Temporary Internet Files** and **Cookies**. Click **Delete**.



Instructions for deleting cookies and temporary Internet files vary with the web browser.

- Disable the proxy server settings, remove any dial-up connections, and set the TCP/IP settings to obtain IP addresses automatically. For more details, refer to the section **Before you proceed** in this user manual.

The client cannot establish a wireless connection with the router.

Out of Range:

- Place the router closer to the wireless client.
- Change the channel settings.

Authentication:

- Use a wired connection to connect to the router.
- Check the wireless security settings.
- Press the Reset button at the rear panel for more than five seconds.

Cannot find the router:

- Press the Reset button at the rear panel for more than five seconds.
- Check the settings in the wireless adapter such as SSID and encryption method.

Cannot access the Internet using a wireless LAN adapter.

- Place the router closer to the wireless client.
- Check whether the wireless adapter is connected to the correct wireless router.
- Check whether the wireless channel in use conforms to the channels available in your country/area.
- Check the encryption settings.
- Check if the ADSL or Cable connection is connected.
- Use a different Ethernet cable.

Internet is not accessible.

- Check the status indicators on the ADSL modem and the wireless router.
- Check if the WAN LED on the wireless router is on. If the LED is off, switch Ethernet cables and try again.

The ADSL Modem “Link” light is ON (steady and not blinking) and means Internet access is possible, but I still cannot browse the Internet.

- Restart your computer.
- Check if the WAN LED on the wireless router is on.
- Check the wireless encryption settings.
- Check if the computer can get an IP address (using both a wired or wireless connection).
- Check that your web browser is configured to use the local LAN and is not configured to use a proxy server.

If the ADSL “LINK” light blinks continuously or stays off, Internet access is not possible - the Router is unable to establish a connection with the ADSL network.

- Ensure that all your cables are properly connected .
- Disconnect the power cord from the ADSL or cable modem, wait a few minutes, then reconnect the cord.
- If the ADSL light continues to blink or stays OFF, contact your Internet service provider.

Network name or encryption keys are forgotten.

- Set up a wired connection and reconfigure the wireless security settings.
- Press the Reset button at the rear panel of the wireless router for more than five seconds.

How do you restore the system to its default settings?

- Press the Reset button at the rear panel of the wireless router for more than five seconds.
- Refer to the section **Restoring/Saving/Uploading settings** of this user manual.

The following are the factory default settings:

User name:	admin
Password:	admin
Enable DHCP:	Yes (if WAN cable is plugged in)
IP address:	192.168.1.1
Domain name:	(Blank)
Subnet Mask	255.255.255.0
DNS Server 1:	192.168.1.1
DNS Server 2:	(Blank)
SSID:	ASUS

ASUS DDNS Service

RT-N10P Series routers support the ASUS DDNS service. If you have registered for the ASUS DDNS service but need to exchange devices at the service center, inform the service center that you want to keep the original domain name and retain the DDNS service. Visit your local service center for more information.



- If there is no activity in the domain - such as reconfiguring the router or accessing the registered domain name - within 90 days, the system automatically deletes the registered information.
- If you encounter any problem or difficulty in using your device, contact the service center.

Frequently Asked Questions (FAQs)

1. Will the registered information be lost or registered by others?

If you have not updated the registered information in 90 days, the system automatically deletes the registered information and the domain name may be registered by others.

2. I did not register the ASUS DDNS for the router I bought six months ago. Can I still register it?

Yes, you can still register the ASUS DDNS service for your router. The DDNS service is embedded in your router, so you can register the ASUS DDNS service anytime. Before registering, click **Query** to check if the hostname has been registered or not. If the hostname is available, the system registers the hostname automatically.

3. I have registered a domain name before and it has been working well until my friends told me that they could not access my domain name.

Check the following:

1. Internet connection is available.
2. The DNS server is working properly.
3. The last time you updated the domain name.

If there are still problems in accessing your domain name, contact the service center.

4. Can I register two domain names so I can access my HTTP and FTP servers separately?

No, you cannot. You can only register one domain name for one router. You can use port mapping to implement security in the network.

5. After restarting the router, why is it that I see a different WAN IP address in MS-DOS and in the router configuration page?

This is normal. The interval time between the ISP DNS server and ASUS DDNS results in different WAN IPs in MS-DOS and in the router configuration page. Different ISPs may have different interval times for updating IP addresses.

6. Is the ASUS DDNS service free, or is it just a trial version?

The ASUS DDNS service is a free and embedded service in some ASUS routers. Check your ASUS router if it supports the ASUS DDNS service.

Appendices

Notices

ASUS Recycling/Takeback Services

ASUS recycling and takeback programs come from our commitment to the highest standards for protecting our environment. We believe in providing solutions for you to be able to responsibly recycle our products, batteries, other components, as well as the packaging materials. Please go to <http://csr.asus.com/english/Takeback.htm> for the detailed recycling information in different regions.

REACH

Complying with the REACH (Registration, Evaluation, Authorisation, and Restriction of Chemicals) regulatory framework, we published the chemical substances in our products at ASUS REACH website at

[**http://csr.asus.com/english/index.aspx**](http://csr.asus.com/english/index.aspx)

Federal Communications Commission Statement

This device complies with Part 15 of the FCC Rules. Operation is subject to the following two conditions:

- This device may not cause harmful interference.
- This device must accept any interference received, including interference that may cause undesired operation.

This equipment has been tested and found to comply with the limits for a class B digital device, pursuant to part 15 of the FCC Rules. These limits are designed to provide reasonable protection against harmful interference in a residential installation.

This equipment generates, uses and can radiate radio frequency energy and, if not installed and used in accordance with the instructions, may cause harmful interference to radio communications. However, there is no guarantee that interference will not occur in a particular installation. If this equipment does cause harmful interference to radio or television reception, which can be determined by turning the equipment off and on, the user is encouraged to try to correct the interference by one or more of the following measures:

- Reorient or relocate the receiving antenna.
- Increase the separation between the equipment and receiver.
- Connect the equipment into an outlet on a circuit different from that to which the receiver is connected.
- Consult the dealer or an experienced radio/TV technician for help.



Any changes or modifications not expressly approved by the party responsible for compliance could void the user's authority to operate the equipment.

Prohibition of Co-location

This device and its antenna(s) must not be co-located or operating in conjunction with any other antenna or transmitter

Safety Information

To maintain compliance with FCC's RF exposure guidelines, this equipment should be installed and operated with minimum distance 20cm between the radiator and your body. Use on the supplied antenna.

Declaration of Conformity for R&TTE directive 1999/5/EC

Essential requirements – Article 3

Protection requirements for health and safety – Article 3.1a

Testing for electric safety according to EN 60950-1 has been conducted. These are considered relevant and sufficient.

Protection requirements for electromagnetic compatibility – Article 3.1b

Testing for electromagnetic compatibility according to EN 301 489-1 and EN 301 489-17 has been conducted. These are considered relevant and sufficient.

Effective use of the radio spectrum – Article 3.2

Testing for radio test suites according to EN 300 328- 2 has been conducted. These are considered relevant and sufficient.

CE Mark Warning

This is a Class B product, in a domestic environment, this product may cause radio interference, in which case the user may be required to take adequate measures.

Canada, Industry Canada (IC) Notices

This Class B digital apparatus complies with Canadian ICES-003 and RSS-210.

Operation is subject to the following two conditions: (1) this device may not cause interference, and (2) this device must accept any interference, including interference that may cause undesired operation of the device.

Radio Frequency (RF) Exposure Information

The radiated output power of the Wireless Device is below the Industry Canada (IC) radio frequency exposure limits. The Wireless Device should be used in such a manner such that the potential for human contact during normal operation is minimized.

This device has been evaluated for and shown compliant with the IC Specific Absorption Rate ("SAR") limits when installed in specific host products operated in portable exposure conditions (antennas are less than 20 centimeters of a person's body).

This device has been certified for use in Canada. Status of the listing in the Industry Canada's REL (Radio Equipment List) can be found at the following web address: <http://www.ic.gc.ca/app/sitt/reltel/srch/nwRdSrch.do?lang=eng>

Additional Canadian information on RF exposure also can be found at the following web: <http://www.ic.gc.ca/eic/site/smt-gst.nsf/eng/sf08792.html>

Canada, avis d'Industry Canada (IC)

Cet appareil numérique de classe B est conforme aux normes canadiennes ICES-003 et RSS-210.

Son fonctionnement est soumis aux deux conditions suivantes: (1) cet appareil ne doit pas causer d'interférence et (2) cet appareil doit accepter toute interférence, notamment les interférences qui peuvent affecter son fonctionnement.

NCC 警語

經型式認證合格之低功率射頻電機，非經許可，公司、商號或使用者均不得擅自變更頻率、加大功率或變更原設計之特性及功能。低功率射頻電機之使用不得影響飛航安全及干擾合法通信；經發現有干擾現象時，應立即停用，並改善至無干擾時方得繼續使用。前項合法通信，指依電信法規定作業之無線電通信。低功率射頻電機須忍受合法通信或工業、科學及醫療用電波輻射性電機設備之干擾。

Authorised distributors in Turkey

BOGAZICI BIL GISAYAR SAN. VE TIC. A.S.

Tel: +90 212 3311000

Address: AYAZAGA MAH. KEMERBURGAZ CAD. NO.10
AYAZAGA/ISTANBUL

CIZGI Elektronik San. Tic. Ltd. Sti.

Tel: +90 212 3567070

Address: CEMAL SURURI CD. HALIM MERIC IS MERKEZI
No: 15/C D:5-6 34394 MECIDIYEKOY/ISTANBUL

GNU General Public License

Licensing information

This product includes copyrighted third-party software licensed under the terms of the GNU General Public License. Please see The GNU General Public License for the exact terms and conditions of this license. We include a copy of the GPL with every CD shipped with our product. All future firmware updates will also be accompanied with their respective source code. Please visit our web site for updated information. Note that we do not offer direct support for the distribution.

GNU GENERAL PUBLIC LICENSE

Version 2, June 1991

Copyright (C) 1989, 1991 Free Software Foundation, Inc.

59 Temple Place, Suite 330, Boston, MA 02111-1307 USA

Everyone is permitted to copy and distribute verbatim copies of this license document, but changing it is not allowed.

Preamble

The licenses for most software are designed to take away your freedom to share and change it. By contrast, the GNU General Public License is intended to guarantee your freedom to share and change free software--to make sure the software is free for all its users. This General Public License applies to most of the Free Software Foundation's software and to any other program whose authors commit to using it. (Some other Free Software Foundation software is covered by the GNU Library General Public License instead.) You can apply it to your programs, too.

When we speak of free software, we are referring to freedom, not price. Our General Public Licenses are designed to make sure that you have the freedom to distribute copies of free software (and charge for this service if you wish), that you receive source code or can get it if you want it, that you can change the software or use

pieces of it in new free programs; and that you know you can do these things.

To protect your rights, we need to make restrictions that forbid anyone to deny you these rights or to ask you to surrender the rights. These restrictions translate to certain responsibilities for you if you distribute copies of the software, or if you modify it.

For example, if you distribute copies of such a program, whether gratis or for a fee, you must give the recipients all the rights that you have. You must make sure that they, too, receive or can get the source code. And you must show them these terms so they know their rights.

We protect your rights with two steps: (1) copyright the software, and (2) offer you this license which gives you legal permission to copy, distribute and/or modify the software.

Also, for each author's protection and ours, we want to make certain that everyone understands that there is no warranty for this free software. If the software is modified by someone else and passed on, we want its recipients to know that what they have is not the original, so that any problems introduced by others will not reflect on the original authors' reputations.

Finally, any free program is threatened constantly by software patents. We wish to avoid the danger that redistributors of a free program will individually obtain patent licenses, in effect making the program proprietary. To prevent this, we have made it clear that any patent must be licensed for everyone's free use or not licensed at all.

The precise terms and conditions for copying, distribution and modification follow.

Terms & conditions for copying, distribution, & modification

0. This License applies to any program or other work which contains a notice placed by the copyright holder saying it may be distributed under the terms of this General Public License. The "Program"; below, refers to any such program or work, and a "work based on the Program" means either the Program or any derivative work under copyright law: that is to say, a work containing the Program or a portion of it, either verbatim or with modifications and/or translated into another language. (Hereinafter, translation is included without limitation in the term "modification".) Each licensee is addressed as "you".

Activities other than copying, distribution and modification are not covered by this License; they are outside its scope. The act of running the Program is not restricted, and the output from the Program is covered only if its contents constitute a work based on the Program (independent of having been made by running the Program). Whether that is true depends on what the Program does.

1. You may copy and distribute verbatim copies of the Program's source code as you receive it, in any medium, provided that you conspicuously and appropriately publish on each copy an appropriate copyright notice and disclaimer of warranty; keep intact all the notices that refer to this License and to the absence of any warranty; and give any other recipients of the Program a copy of this License along with the Program.

You may charge a fee for the physical act of transferring a copy, and you may at your option offer warranty protection in exchange for a fee.

2. You may modify your copy or copies of the Program or any portion of it, thus forming a work based on the Program, and copy and distribute such modifications or work under the terms of Section 1 above, provided that you also meet all of these conditions:

- a) You must cause the modified files to carry prominent notices stating that you changed the files and the date of any change.
- b) You must cause any work that you distribute or publish, that in whole or in part contains or is derived from the Program or any part thereof, to be licensed as a whole at no charge to all third parties under the terms of this License.
- c) If the modified program normally reads commands interactively when run, you must cause it, when started running for such interactive use in the most ordinary way, to print or display an announcement including an appropriate copyright notice and a notice that there is no warranty (or else, saying that you provide a warranty) and that users may redistribute the program under these conditions, and telling the user how to view a copy of this License. (Exception: if the Program itself is interactive but does not normally print such an announcement, your work based on the Program is not required to print an announcement.)

These requirements apply to the modified work as a whole. If identifiable sections of that work are not derived from the Program, and can be reasonably considered independent and separate works in themselves, then this License, and its terms, do not apply to those sections when you distribute them as separate works. But when you distribute the same sections as part of a whole which is a work based on the Program, the distribution of the whole must be on the terms of this License, whose permissions for other licensees extend to the entire whole, and thus to each and every part regardless of who wrote it.

Thus, it is not the intent of this section to claim rights or contest your rights to work written entirely by you; rather, the intent is to exercise the right to control the distribution of derivative or collective works based on the Program.

In addition, mere aggregation of another work not based on the Program with the Program (or with a work based on the Program) on a volume of a storage or distribution medium does not bring the other work under the scope of this License.

3. You may copy and distribute the Program (or a work based on it, under Section 2) in object code or executable form under the terms of Sections 1 and 2 above provided that you also do one of the following:
 - a) Accompany it with the complete corresponding machine-readable source code, which must be distributed under the terms of Sections 1 and 2 above on a medium customarily used for software interchange; or,
 - b) Accompany it with a written offer, valid for at least three years, to give any third party, for a charge no more than your cost of physically performing source distribution, a complete machine-readable copy of the corresponding source code, to be distributed under the terms of Sections 1 and 2 above on a medium customarily used for software interchange; or,
 - c) Accompany it with the information you received as to the offer to distribute corresponding source code. (This alternative is allowed only for noncommercial distribution and only if you received the program in object code or executable form with such an offer, in accord with Subsection b above.)

The source code for a work means the preferred form of the work for making modifications to it. For an executable work, complete source code means all the source code for all modules it contains, plus any associated interface definition files, plus the scripts used to control compilation and installation of the executable. However, as a special exception, the source code distributed need not include anything that is normally distributed (in either source or binary form) with the major components (compiler, kernel, and so on) of the operating system on which the executable runs, unless that component itself accompanies the executable.

If distribution of executable or object code is made by offering access to copy from a designated place, then offering equivalent access to copy the source code from the same place counts as distribution of the source code, even though third parties are not compelled to copy the source along with the object code.

4. You may not copy, modify, sublicense, or distribute the Program except as expressly provided under this License. Any attempt otherwise to copy, modify, sublicense or distribute the Program is void, and will automatically terminate your rights under this License. However, parties who have received copies, or rights, from you under this License will not have their licenses terminated so long as such parties remain in full compliance.
5. You are not required to accept this License, since you have not signed it. However, nothing else grants you permission to modify or distribute the Program or its derivative works. These actions are prohibited by law if you do not accept this License. Therefore, by modifying or distributing the Program (or any work based on the Program), you indicate your acceptance of this License to do so, and all its terms and conditions for copying, distributing or modifying the Program or works based on it.
6. Each time you redistribute the Program (or any work based on the Program), the recipient automatically receives a license from the original licensor to copy, distribute or modify the Program subject to these terms and conditions. You may not impose any further restrictions on the recipients' exercise of the rights granted herein. You are not responsible for enforcing compliance by third parties to this License.
7. If, as a consequence of a court judgment or allegation of patent infringement or for any other reason (not limited to patent issues), conditions are imposed on you (whether by court order, agreement or otherwise) that contradict the conditions of this License, they do not excuse you from the conditions of this License. If you cannot distribute so as to satisfy simultaneously

your obligations under this License and any other pertinent obligations, then as a consequence you may not distribute the Program at all. For example, if a patent license would not permit royalty-free redistribution of the Program by all those who receive copies directly or indirectly through you, then the only way you could satisfy both it and this License would be to refrain entirely from distribution of the Program.

If any portion of this section is held invalid or unenforceable under any particular circumstance, the balance of the section is intended to apply and the section as a whole is intended to apply in other circumstances.

It is not the purpose of this section to induce you to infringe any patents or other property right claims or to contest validity of any such claims; this section has the sole purpose of protecting the integrity of the free software distribution system, which is implemented by public license practices. Many people have made generous contributions to the wide range of software distributed through that system in reliance on consistent application of that system; it is up to the author/donor to decide if he or she is willing to distribute software through any other system and a licensee cannot impose that choice.

This section is intended to make thoroughly clear what is believed to be a consequence of the rest of this License.

8. If the distribution and/or use of the Program is restricted in certain countries either by patents or by copyrighted interfaces, the original copyright holder who places the Program under this License may add an explicit geographical distribution limitation excluding those countries, so that distribution is permitted only in or among countries not thus excluded. In such case, this License incorporates the limitation as if written in the body of this License.
9. The Free Software Foundation may publish revised and/or new versions of the General Public License from time to time. Such new versions will be similar in spirit to the present version, but may differ in detail to address new problems or concerns.

Each version is given a distinguishing version number. If the Program specifies a version number of this License which applies to it and "any later version," you have the option of following the terms and conditions either of that version or of any later version published by the Free Software Foundation. If the Program does not specify a version number of this License, you may choose any version ever published by the Free Software Foundation.

10. If you wish to incorporate parts of the Program into other free programs whose distribution conditions are different, write to the author to ask for permission.

For software which is copyrighted by the Free Software Foundation, write to the Free Software Foundation; we sometimes make exceptions for this. Our decision will be guided by the two goals of preserving the free status of all derivatives of our free software and of promoting the sharing and reuse of software generally.

NO WARRANTY

11. BECAUSE THE PROGRAM IS LICENSED FREE OF CHARGE, THERE IS NO WARRANTY FOR THE PROGRAM, TO THE EXTENT PERMITTED BY APPLICABLE LAW. EXCEPT WHEN OTHERWISE STATED IN WRITING THE COPYRIGHT HOLDERS AND/OR OTHER PARTIES PROVIDE THE PROGRAM "AS IS" WITHOUT WARRANTY OF ANY KIND, EITHER EXPRESSED OR IMPLIED, INCLUDING, BUT NOT LIMITED TO, THE IMPLIED WARRANTIES OF MERCHANTABILITY AND FITNESS FOR A PARTICULAR PURPOSE. THE ENTIRE RISK AS TO THE QUALITY AND PERFORMANCE OF THE PROGRAM IS WITH YOU. SHOULD THE PROGRAM PROVE DEFECTIVE, YOU ASSUME THE COST OF ALL NECESSARY SERVICING, REPAIR OR CORRECTION.

12 IN NO EVENT UNLESS REQUIRED BY APPLICABLE LAW OR AGREED TO IN WRITING WILL ANY COPYRIGHT HOLDER, OR ANY OTHER PARTY WHO MAY MODIFY AND/OR REDISTRIBUTE THE PROGRAM AS PERMITTED ABOVE, BE LIABLE TO YOU FOR DAMAGES, INCLUDING ANY GENERAL, SPECIAL, INCIDENTAL OR CONSEQUENTIAL DAMAGES ARISING OUT OF THE USE OR INABILITY TO USE THE PROGRAM (INCLUDING BUT NOT LIMITED TO LOSS OF DATA OR DATA BEING RENDERED INACCURATE OR LOSSES SUSTAINED BY YOU OR THIRD PARTIES OR A FAILURE OF THE PROGRAM TO OPERATE WITH ANY OTHER PROGRAMS), EVEN IF SUCH HOLDER OR OTHER PARTY HAS BEEN ADVISED OF THE POSSIBILITY OF SUCH DAMAGES.

END OF TERMS AND CONDITIONS

Networks Global Hotline Information

Region	Country	Hotline Number	Service Hours	
Europe	Cyprus	800-92491	09:00-13:00 ; 14:00-18:00 Mon-Fri	
	France	0033-170949400	09:00-18:00 Mon-Fri	
	Germany	0049-1805010920		
		0049-1805010923		09:00-18:00 Mon-Fri
		(component support) 0049-2102959911 (Fax)		10:00-17:00 Mon-Fri
	Hungary	0036-15054561	09:00-17:30 Mon-Fri	
	Italy	199-400089	09:00-13:00 ; 14:00-18:00 Mon-Fri	
	Greece	00800-44142044	09:00-13:00 ; 14:00-18:00 Mon-Fri	
	Austria	0043-820240513	09:00-18:00 Mon-Fri	
	Netherlands/ Luxembourg	0031-591570290	09:00-17:00 Mon-Fri	
	Belgium	0032-78150231	09:00-17:00 Mon-Fri	
	Norway	0047-2316-2682	09:00-18:00 Mon-Fri	
	Sweden	0046-858769407	09:00-18:00 Mon-Fri	
	Finland	00358-969379690	10:00-19:00 Mon-Fri	
	Denmark	0045-38322943	09:00-18:00 Mon-Fri	
	Poland	0048-225718040	08:30-17:30 Mon-Fri	
	Spain	0034-902889688	09:00-18:00 Mon-Fri	
	Portugal	00351-707500310	09:00-18:00 Mon-Fri	
	Slovak Republic	00421-232162621	08:00-17:00 Mon-Fri	
	Czech Republic	00420-596766888	08:00-17:00 Mon-Fri	
	Switzerland-German	0041-848111010	09:00-18:00 Mon-Fri	
	Switzerland-French	0041-848111014	09:00-18:00 Mon-Fri	
	Switzerland-Italian	0041-848111012	09:00-18:00 Mon-Fri	
United Kingdom	0044-8448008340	09:00-17:00 Mon-Fri		
Ireland	0035-31890719918	09:00-17:00 Mon-Fri		
Russia and CIS	008-800-100-ASUS	09:00-18:00 Mon-Fri		
Ukraine	0038-0445457727	09:00-18:00 Mon-Fri		

Region	Country	Hotline Numbers	Service Hours	
Asia-Pacific	Australia	1300-278788	09:00-18:00 Mon-Fri	
	New Zealand	0800-278788	09:00-18:00 Mon-Fri	
	Japan	0800-1232787	09:00-18:00 Mon-Fri	09:00-17:00 Sat-Sun
			0081-473905630 (Non-Toll Free)	09:00-18:00 Mon-Fri 09:00-17:00 Sat-Sun
	Korea	0082-215666868	09:30-17:00 Mon-Fri	
	Thailand	0066-24011717 1800-8525201	09:00-18:00 Mon-Fri	
			Singapore	0065-64157917 0065-67203835 (Repair Status Only)
	Malaysia	0060-320535077	10:00-19:00 Mon-Fri	
	Philippine	1800-18550163	09:00-18:00 Mon-Fri	
	India	1800-2090365	09:00-18:00 Mon-Sat	09:00-21:00 Mon-Sun
			India(WL/NW)	
	Indonesia	0062-2129495000 500128 (Local Only)	09:30-17:00 Mon-Fri	9:30 – 12:00 Sat
			Vietnam	1900-555581
	Americas	Hong Kong	00852-35824770	10:00-19:00 Mon-Sat
		USA	1-812-282-2787	8:30-12:00 EST Mon-Fri
Canada		9:00-18:00 EST Sat-Sun		
Mexico		001-8008367847	08:00-20:00 CST Mon-Fri	08:00-15:00 CST Sat

Region	Country	Hotline Numbers	Service Hours
Middle East + Africa	Egypt	800-2787349	09:00-18:00 Sun-Thu
	Saudi Arabia	800-1212787	09:00-18:00 Sat-Wed
	UAE	00971-42958941	09:00-18:00 Sun-Thu
	Turkey	0090-2165243000	09:00-18:00 Mon-Fri
	South Africa	0861-278772	08:00-17:00 Mon-Fri
	Israel	*6557/00972-39142800	08:00-17:00 Sun-Thu
		*9770/00972-35598555	08:30-17:30 Sun-Thu
Romania	0040-213301786	09:00-18:30 Mon-Fri	
Balkan Countries	Bosnia Herzegovina	00387-33773163	09:00-17:00 Mon-Fri
		Bulgaria	00359-70014411
		00359-29889170	09:30-18:00 Mon-Fri
	Croatia	00385-16401111	09:00-17:00 Mon-Fri
	Montenegro	00382-20608251	09:00-17:00 Mon-Fri
	Serbia	00381-112070677	09:00-17:00 Mon-Fri
	Slovenia	00368-59045400	08:00-16:00 Mon-Fri
		00368-59045401	
	Estonia	00372-6671796	09:00-18:00 Mon-Fri
	Latvia	00371-67408838	09:00-18:00 Mon-Fri
	Lithuania-Kaunas	00370-37329000	09:00-18:00 Mon-Fri
Lithuania-Vilnius	00370-522101160	09:00-18:00 Mon-Fri	



For more information, visit the ASUS support site at:
<http://support.asus.com>

ASUS Contact information

ASUSTeK COMPUTER INC. (Asia Pacific)

Address 15 Li-Te Road, Peitou, Taipei, Taiwan 11259
Website www.asus.com.tw

Technical Support

Telephone +886228943447
Support Fax +886228907698
Online support support.asus.com

ASUS COMPUTER INTERNATIONAL (America)

Address 800 Corporate Way, Fremont, CA 94539, USA
Telephone +15107393777
Fax +15106084555
Website usa.asus.com
Online support support.asus.com

ASUS COMPUTER GmbH (Germany and Austria)

Address Harkort Str. 21-23, D-40880 Ratingen, Germany
Telephone +491805010923*
Fax +492102959911
Website www.asus.de
Online contact www.asus.de/sales

Technical Support

Telephone (Component, Networking) +491805010923*
Telephone (System/Notebook/Eee/LCD) +491805010920*
Fax +492102959911
Online support support.asus.com

* EUR 0.14/minute from a German fixed landline; EUR 0.42/minute from a mobile phone.

Manufacturer:	ASUSTeK Computer Inc. Tel: +886-2-2894-3447 Address: 4F, No. 150, LI-TE RD., PEITOU, TAIPEI 112, TAIWAN
Authorised representative in Europe:	ASUS Computer GmbH Address: HARKORT STR. 21-23, 40880 RATINGEN, GERMANY

EEE Yönetmeliğine Uygundur.

Free Manuals Download Website

<http://myh66.com>

<http://usermanuals.us>

<http://www.somanuals.com>

<http://www.4manuals.cc>

<http://www.manual-lib.com>

<http://www.404manual.com>

<http://www.luxmanual.com>

<http://aubethermostatmanual.com>

Golf course search by state

<http://golfingnear.com>

Email search by domain

<http://emailbydomain.com>

Auto manuals search

<http://auto.somanuals.com>

TV manuals search

<http://tv.somanuals.com>