

# INSTRUCTIONS



Thank you for purchasing this headset. Before using this headset, please read through these operating instructions to ensure that you will use the headset correctly.

## Information

This device complies with Part 15 of FCC Rules and RSS-Gen of IC Rules. Operation is subject to the following conditions: (1) this device may not cause harmful interference, and (2) this device must accept any interference received, including interference that may cause undesired operation of this device.

You are cautioned that any changes or modifications not expressly approved in this manual could void your authority to operate this equipment.

## Note

This equipment has been tested and found to comply with the limits for a Class B digital device, pursuant to Part 15 of the FCC Rules. These limits are designed to provide reasonable protection against harmful interference in a residential installation. This equipment generates, uses and can radiate radio frequency energy and, if not installed and used in accordance with the instructions, may cause harmful interference to radio or television reception, which can be determined by turning the equipment off and on, the user is encouraged to try to correct the interference by one or more of the following measures:

- Reorient or relocate the receiving antenna.
- Increase the separation between the equipment and receiver.
- Connect the equipment into an outlet on a circuit different from that to which the receiver is connected.
- Consult the dealer or an experienced radio/TV technician for help.

## Verifying package contents

Before you start using the product, make sure that all the following articles have been supplied. If any article is not supplied or is damaged, contact your Audio-Technica dealer.

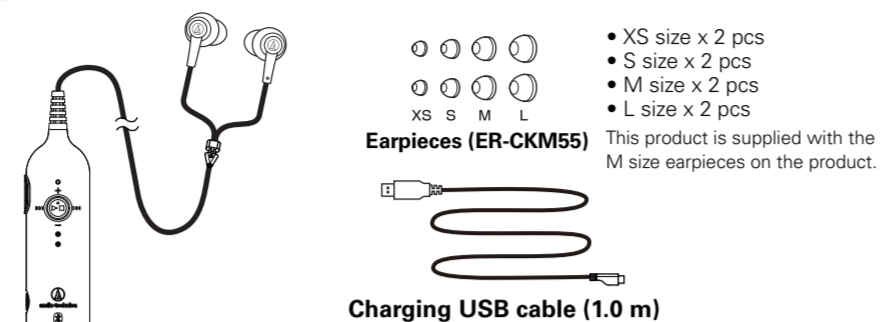

ATH-BT03

## Headset parts

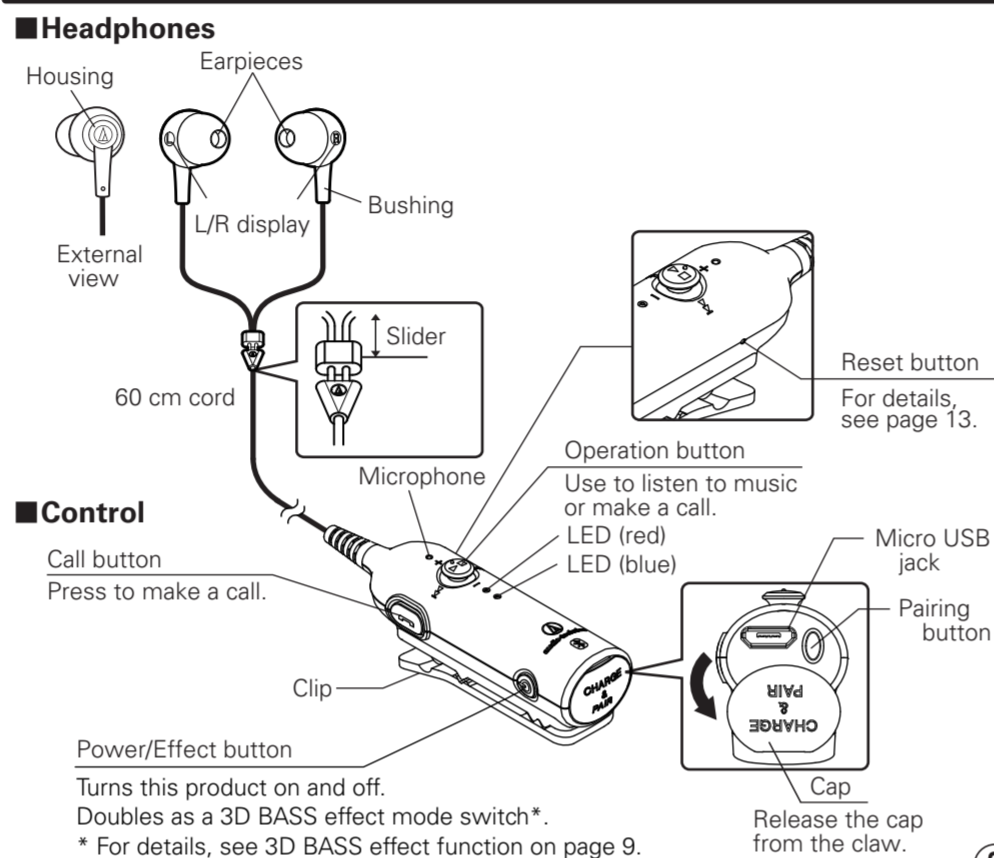

### Control

- Call button**  
Press to make a call.
- Power/Effect button**  
Turns this product on and off. Doubles as a 3D BASS effect mode switch\*.
- Operation button**  
Use to listen to music or make a call.
- LED (red)**
- LED (blue)**
- Micro USB jack**
- Pairing button**
- Cap**  
Release the cap from the claw.

①

③

## Bluetooth devices

This product uses the 2.4 GHz frequency band. Be sure to read and observe the following instructions to prevent interference with other devices using this frequency band.

The frequency band used by the product is also used by microwave ovens and other industrial, scientific and medical instruments as well as short range wireless base stations for identifying mobile devices (requires a license) on plant production lines, specified low power base stations (does not require a license) and amateur radio stations (requires a license).

- Before using this product, make sure there are no short range wireless base stations for identifying mobile devices, specified low power base stations or amateur radio stations nearby.
- In the unlikely event that use of this product causes serious interference with a short range wireless base station for identifying mobile devices, stop transmitting radio waves immediately. Then contact your Audio-Technica dealer regarding interferences countermeasures (for example, installing partitions, etc.) to prevent interferences.
- Also contact your Audio-Technica dealer regarding other problems involving serious interference with a short range wireless base station for identifying mobile devices and amateur radio stations or questions regarding such interference.

- Available operating range  
The product operates up to 10 meters from a transmitting Bluetooth device, however obstacles between the transmitting Bluetooth device and the product or the structure of the building you are in may reduce the operating distance.
- Interference with other devices  
Microwave ovens, digital cordless phones, devices using wireless LAN, Bluetooth devices and other devices using the same 2.4 GHz frequency band may cause dropouts. Similarly, since this product will also interfere with such devices, it is essential that devices that are likely to interfere with each other are kept apart.
- Note that Audio-Technica accepts no liability whatsoever for leakage of data during Bluetooth transmission.

## Supported Bluetooth version and profile

This product supports the following Bluetooth version and profile.

- Communication system: Bluetooth Ver. 2.1 + EDR
- Compatible Bluetooth Profiles:
  - A2DP (Advanced Audio Distribution Profile): Sends and receives stereo quality audio data
  - AVRCP (Audio Video Remote Control Profile): Play, stop, skip, volume control and other AV device controls
  - HSP (Headset Profile): Making calls, receiving incoming and making outgoing mobile phone calls
  - HFP (Hands-Free Profile): Making hands-free calls and receiving incoming and making outgoing mobile phone calls with hands-free

②

## Charging

This product is not charged when purchased. You must charge the product before you can start using it.

- Remove the cap from the product and connect the supplied USB charging cable to the micro USB jack.
  - Correctly connect the USB charging cable to the USB port of a PC\*1.
  - When charging starts the blue LED blinks and the red LED lights. After about three to four hours of charging the red LED will go off indicating that charging is completed. \*2
    - \*1 If the USB cable is not properly connected, the red LED on the case blinks.
    - \*2 This is the time it normally takes to charge an empty battery.
- If power from the last charge remains, charging will end sooner.

### Connection diagram

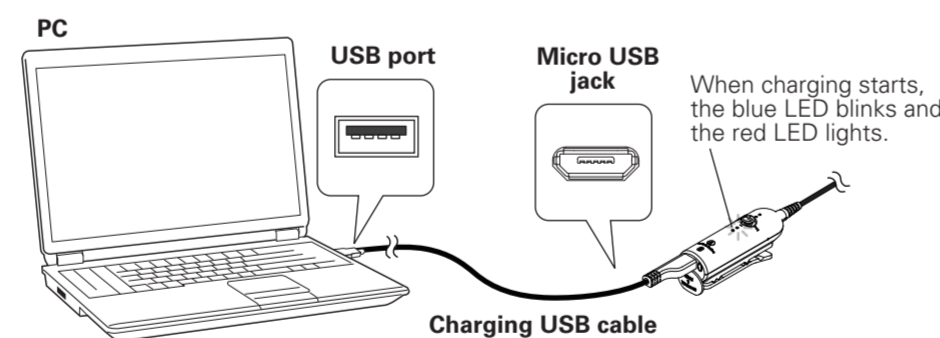

### When battery power is low

A warning sound is heard and the red LED and the blue LED both blink at 0.5 second intervals. When the battery becomes completely depleted, an ending sound is heard and the power is automatically turned off. When the LED start blinking, charge the product according to the above instructions.

## Operating time\*

Continuous transmission (including music playback time): Max. 6 hours  
Continuous standby time: Max. 200 hours  
\* The above figures depend on operating conditions.

- The following conditions during charging may cause the red LED to go off before charging completes.
    - At temperatures outside the operating temperature range (5 to 45°C)
    - The rechargeable battery is defective
- If this happens, charge the battery again at the temperature range above. If the battery still cannot be recharged, contact your Audio-Technica dealer.

④

- The rechargeable battery may not operate long on the first charge and when it has been recharged after a long period after not being used. After repeated charging and discharging, it will become possible to adequately charge the battery.
- The rechargeable battery has reached the end of its service life when battery operating time after charging shrinks to about half of what it first was. Contact your Audio-Technica dealer to have the rechargeable battery replaced.
- Do not expose the battery to sudden temperature changes, direct sunlight, condensation, sand, dust or electrical shocks. Never leave it in a parked car.
- The battery will not be properly charged if the product or the PC enters an energy saving mode during charging. Check PC settings before connecting the product to a PC. The red LED will go off automatically also when the PC enters an energy saving mode. Should this happen, recharge the battery.
- Connect the product directly to the PC using the supplied USB cable. Do not use a USB hub or USB extension cable to connect to a PC. Be sure to fully insert the plug of the USB cable into the USB port.

## Note

Lithium polymer rechargeable battery is used for this headset. When disposing of this headset, please comply with local regulations.

## Pairing

Use this procedure to pair devices beforehand to allow them to communicate with each other. Bluetooth devices should first be paired before connection. To hear the verifying beep of pairing, put on the headphones before you start the pairing procedure.

- For information on how to put on the headphones, see "Listening to music" on page 7.
- Also read the instruction manuals supplied with the products that are to be connected.

- Place the Bluetooth devices within one meter of each other.
- With the product in power off mode, press and hold the Power/Effect button for three seconds or longer. The blue LED will blink three times as the product is turned on.
- Press and hold the Pairing button for three seconds or longer to activate the pairing mode. A beep sound will be heard to indicate that pairing has started. The red and blue LEDs will blink alternately during pairing. \*Pairing may take a while.
- Perform pairing on the other Bluetooth device to find the product. The screen of the other Bluetooth device will display a list of found devices. This product will appear as "ATH-BT03" on the screen.
- Select "ATH-BT03" displayed on the screen of the other Bluetooth device. \*When you are prompted for a pass code on the screen of the other Bluetooth device, enter 0000.

When the blue LED changes to slow blinking, pairing is complete.

⑤

- To connect to multiple profiles, the pairing procedure in steps 4 and 5 will have to be repeated several times.
- Some devices perform Bluetooth connection automatically to load a compatible profile. For details, refer to the instruction manual supplied with your mobile phone.
- If pairing is not completed within five minutes, the product will terminate pairing mode and shut down. Should this happen, perform the pairing procedure again.
- The Reset button (-> page 13) cannot be used to delete pairing data.

## Operation during pairing

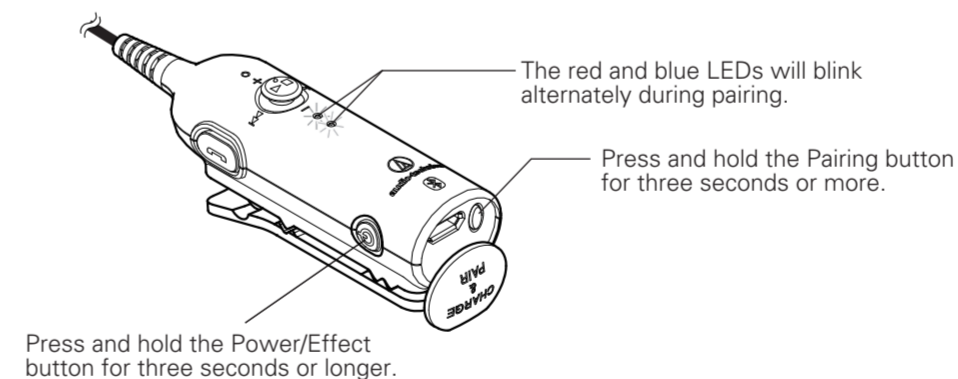

Bluetooth devices that have been paired may have to be paired again under the following conditions

- When 9 or more Bluetooth devices have been paired (The product allows pairing for up to 8 devices. When you pair an additional device after having paired the product with 8 devices, this pairing will overwrite the oldest pairing data.)
- When the pairing data in the product has been deleted due to a repair, for example.
- When connection history data in the other Bluetooth device has been deleted.

⑥

## Listening to music

This product supports SCMS-T, a content protection method for Bluetooth wireless technology. It allows you to listen to music (or audio) from mobile phones, One-Seg TVs and other devices that support SCMS-T.

Confirm the following before starting to use.

- The transmitting Bluetooth device is on.
  - This product and the transmitting device have been paired.
  - The transmitting Bluetooth device supports the music transmission function (profile: A2DP\*)
- \*For information on profiles, refer to "Supported Bluetooth version and profiles" on page 2.

- Put on your headphones as shown in the figure on the right. Place the left headphone (marked L) in your left ear and the right headphone (marked R) in the right ear.
- With this product in power off mode, press and hold the POWER/EFFECT button for three seconds or longer. The startup chime sounds and the blue LED will blink three times as this product is turned on.
- Refer to the instruction manual of the transmitting Bluetooth device to connect the Bluetooth device.
- Start playback on the transmitting Bluetooth device. The blue LED blinks during Bluetooth connection.

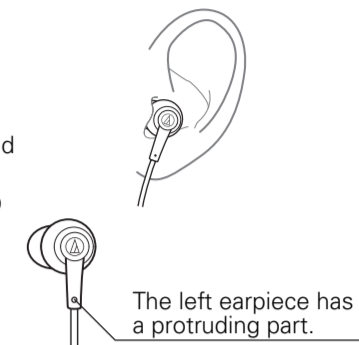

## Controlling a transmitting Bluetooth device

If the transmitting Bluetooth device supports operation control functions (Bluetooth profile: AVRCP), you can use the Operation button on this product to control the transmitting Bluetooth device\*. \*Some transmitting Bluetooth devices may not support this function.

- Briefly press the center, the (P) of the Operation button to play and pause
- Press and hold the (P) of the Operation button to stop
- Briefly press the (F) of the Operation button to forward tracks/and press and hold for fast forward
- Briefly press the (B) of the Operation button to reverse tracks/and press and hold for fast backward

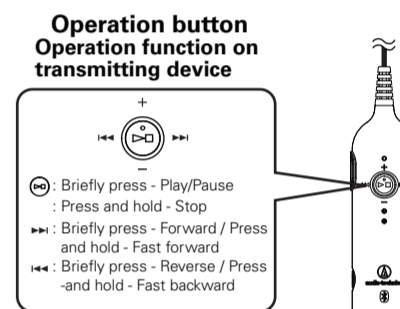

⑦

## To adjust the volume

- Press the top and bottom of the Operation button to adjust the sound volume. Press the top (+) of the Operation button to increase the sound volume and press the bottom (-) to decrease it. Pressing and holding the Operation button will also allow you to adjust the volume\*.
- \*A warning beep is heard when maximum or minimum sound volume is selected and the sound cannot be set any higher or lower.

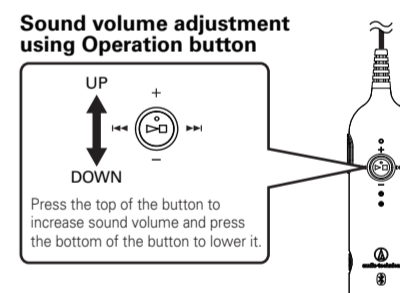

- Turn off this product when you are through listening. Set the transmitting Bluetooth device to disconnect Bluetooth connection. After use, press and hold the Power/Effect button for three seconds or longer to turn this product off. The ending chime is heard and this product is turned off.

⑧

## 3D BASS effect function

Use the POWER/EFFECT button to turn the 3D BASS effect function on and off. The 3D BASS effect function employs SRS WOW HD™ technology developed by SRS Labs, Inc.

※ The 3D BASS effect function is turned on by default.

**SRS** WOW HD™ significantly improves the playback quality of audio, delivering a dynamic 3D entertainment experience with deep, rich bass and high frequency clarity for crisp detail. SRS is a trademark or registered trademark of SRS Labs, Inc. WOW HD technology is incorporated under license from SRS Labs, Inc.

### Using 3D BASS effect function

Briefly press\* the POWER/EFFECT button during music playback, a beep is heard and the blue LED goes on for one second.

※ The 3D BASS effect function is turned on by default.

\* Pressing and holding the Effect button for three seconds or longer will turn off the headsets.

#### Blue LED

When the 3D BASS effect function is on, the blue LED goes on for one second. When the 3D BASS effect function is cancelled, the red LED goes on for one second.

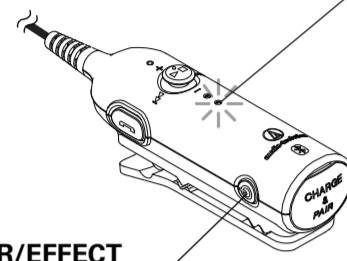

#### POWER/EFFECT button

Briefly press the button to turn on the 3D BASS effect function during music playback.

Pressing the POWER/EFFECT button briefly again will result in two beep sounds and the red LED will go on for one second indicating the 3D BASS effect function has been cancelled.

※ The 3D BASS effect may distort some types of music. If this happens, turn the 3D BASS effect function off.

## Calls during music playback

To call during music playback requires not only A2DP, but also HFP or HSP Bluetooth connection.

- Use the steps described under "Making calls" (on page 10) using HFP or HSP to make a Bluetooth connection from your mobile phone.  
※ For details, refer to the instruction manual supplied with your mobile phone.
- Operate the Bluetooth device (portable player or mobile phone) that plays back music to establish a Bluetooth connection using A2DP with this product.

### Redialing during music playback

Press and hold the Call button for two seconds or longer during music playback to redial. The music pauses while a call is made to the last dialed phone number.

### Receiving a call during music playback

When an incoming call is received, the music pauses and the ring tone is heard from the headphones of this product.

- Press the Call button on this product to take the call.
- When the call ends, press the Call button to end it. This product resumes music playback.

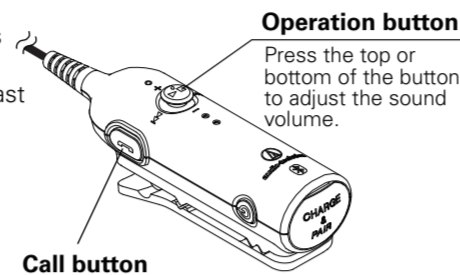

### If the ring tone cannot be heard during music playback, use the following steps.

- Pause music playback.
- When the ring tone is heard, press the Call button to take the call.

## Reset function

If this product fails to respond (to buttons being pressed, for example), use the Reset button to clear up the problem. Use the steps below to reset this product using the Reset button on the right side of the controller.

- Reset this product.
- Insert a thin stick in the reset hole and press as shown in the figure on the right until you can feel the Reset button has been pressed. Pressing the reset button will turn off this product.

※ This operation will not delete pairing data.

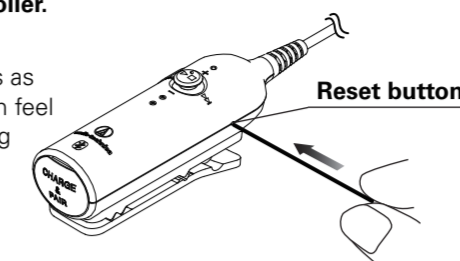

## Troubleshooting Guide

### Q1. The power does not go on

- A1. Check whether the battery is properly charged.
- A2. Check whether the battery is recharging. The power will not go on during charging.

### Q2. Pairing is not possible or does not complete

- A1. Check whether this product and the other Bluetooth device are placed too far apart. --> Place this product and the other Bluetooth device within one meter of each other and perform pairing again.
- A2. Check whether the other Bluetooth device is a compatible device. Check compatibility.
- A3. Check whether profiles have been set up. --> Refer to the instruction manual of the other Bluetooth device to complete the profile setup on that device.

### Q3. A Bluetooth connection cannot be made

- A1. Check whether this product and the other Bluetooth device are powered up. --> If not on, turn them on.
- A2. Check whether the Bluetooth function on the other Bluetooth device is enabled. --> Enable the Bluetooth function.

### Q4. No music output

- A1. Check whether this product and the other Bluetooth device are powered up. --> If not on, turn them on.
- A2. Check whether this product and the other Bluetooth device are connected using A2DP. --> Connect using A2DP.
- A3. Check whether the other Bluetooth device is playing back music. --> Set it to play back music.
- A4. Check whether the sound volume on this product or the connected device is too low. --> Turn up the sound volume.

## Making calls

Before making calls on a mobile phone with Bluetooth, confirm the following.

- The Bluetooth on the mobile is enabled.
- This product and the Bluetooth mobile phone have been paired and set to use HSP or HFP.

- With this product in power off mode, press and hold the POWER/EFFECT button for three seconds or longer to turn the power on.
- Refer to the instruction manual of the transmitting Bluetooth device to connect the Bluetooth device.  
"ATH-BT03" appears in the list on the Bluetooth mobile phone screen.  
When a Bluetooth mobile phone supporting HFP and HSP is used, connect using HFP.  
※ For details on profiles, see "Supported Bluetooth version and profile" (-> page 2).

### Receiving phone calls

When there is an incoming call, a ring tone is heard from the headphones. Press the Call button to take the call.

※ Press and hold the Call button for two seconds or longer to reject a call.

### Making a call

Use your mobile phone to make a call. If you cannot hear the dial tone from this product, press and hold the Call button for two seconds or longer.

### Redialing a call

Press and hold the Call button for two seconds or longer when the mobile phone is in standby mode. The phone dials last dialed number again.  
※ The procedure for redialing may differ depending on mobile phone. Use the top and bottom part of the Operation button to adjust the sound volume.

### Ending a call

Press the Call button on this product to end the call.

### After use

Set the transmitting Bluetooth device to disconnect Bluetooth connection. After use, press and hold the POWER/EFFECT button for three seconds or longer to turn this product off.

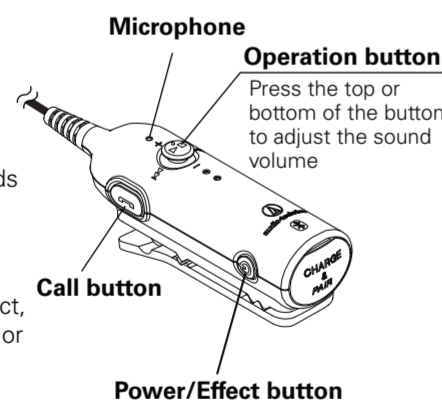

## Cleaning

Get into the habit of regularly cleaning your headphones to ensure that they will last for a long time. Do not use alcohol, paint thinners or other solvents for cleaning purposes.

### Controller

To clean, wipe with a dry cloth.

### Headphones

To clean, wipe with a dry cloth. Do not touch the parts used for sound reproduction (※ see figure at right) as they are delicate. Damage to the headphones may result.

### Cords

Wipe away perspiration and any other dirt with a dry cloth after use.

Cords that are not cleaned may deteriorate and cause a malfunction.

### Earpieces

- ◆ Size and type of earpieces  
Unless the earpieces properly fit the ear, you will not hear the bass properly. This product comes with four sizes of silicon earpieces: XS, S, M and L. The medium sized earpieces are attached to the earpieces at shipment. The earpieces must fit the inner ear to provide a high quality music experience. If the medium sized earpieces do not fit, change to a size that does.

- ◆ Cleaning procedure  
Remove earpieces from the headphones and clean them with a diluted detergent. After cleaning, dry before use.

- ◆ Replacing earpieces  
Remove a worn earpiece and replace it with a new one as shown in the figure on the right. Be sure to fully insert the earpiece so that it is flush with the base of the earpiece.

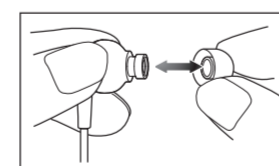
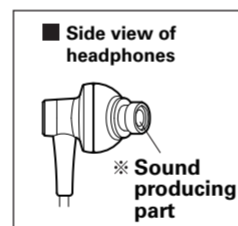

### CAUTION

- The earpieces pick up dirt easily and should be regularly cleaned. If the earpieces are not cleaned, the sound producing parts may become contaminated and sound quality will degrade.
- The earpieces are consumable parts and will deteriorate from storage and use. Earpieces that no longer fit properly or show signs of wear should be replaced at the earliest opportunity. Contact your Audio-Technica dealer for purchasing consumables and other parts.
- Make sure that a removed earpiece is properly installed on the earpiece before use. Otherwise the earpiece could be lodged inside the ear and would have to be removed to prevent injury or disease.

## Specifications

### Control

- Communication System : Bluetooth Version 2.1+EDR
- Output : Bluetooth Specification Power Class2
- Maximum communication range : Line of sight approx. 10 m
- Frequency band : 2.4 GHz band (2.402 GHz-2.480 GHz)
- Compatible Bluetooth Profiles : A2DP, AVRCP, HFP, HSP
- Support Codec : SBC
- Supported content protection method : SCMS-T
- Power source : DC3.7V Built-in-lithium-polymer rechargeable battery

- Microphone element : Electret condenser
- Microphone direction characteristic : Omnidirectional
- Microphone sensitivity : -40 dB (1 V/Pa, at 1 KHz)
- Microphone effective frequency range : 10-4,000 Hz
- Dimensions : W19×H64×D25 mm (excluding projecting parts)
- Weight : Approx. 15 g
- Operating temperature : 5 °C to 45 °C
- Accessories : USB charging cable, Earpieces (XS/S/M/L)
- Spare earpieces (available separately) : ER-CKM55 (XS/S/M/L)

### Headphones

- Driver : Dynamic φ8.8 mm
- Output sound pressure level : 100 dB/mW
- Frequency response : 20-20,000Hz
- Impedance : 16 Ω
- Cord length : 60 cm (Y-type)
- Weight : Approx. 6 g (including cord)

(For product improvement, this product is subject to modification without notice.)

The Bluetooth word mark and logos are owned by the Bluetooth SIG, Inc. and any use of such marks by Audio-Technica Corporation is under license. All other trademarks are property of their respective owners.

**audio-technica**  
Audio-Technica Corp.  
2206 Naruse, Machida, Tokyo 194-8666, Japan  
©2011 Audio-Technica Corp.

9

11

13

10

12

14

## Free Manuals Download Website

<http://myh66.com>

<http://usermanuals.us>

<http://www.somanuals.com>

<http://www.4manuals.cc>

<http://www.manual-lib.com>

<http://www.404manual.com>

<http://www.luxmanual.com>

<http://aubethermostatmanual.com>

Golf course search by state

<http://golfingnear.com>

Email search by domain

<http://emailbydomain.com>

Auto manuals search

<http://auto.somanuals.com>

TV manuals search

<http://tv.somanuals.com>