

BODYGUARD

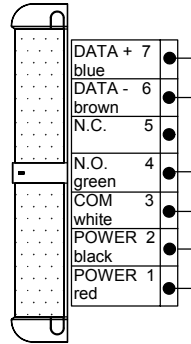

24 V TRANSFORMER

EAGLE

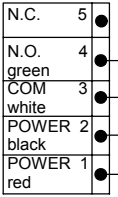
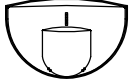

LE-21

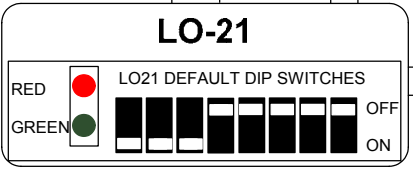
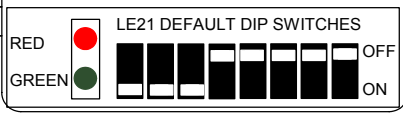

SAFETY SIDE SUPERSCAN

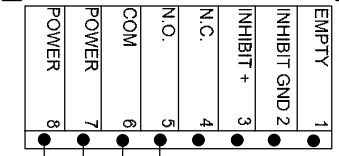

FOR PAIR OF DOORS

SAFETY SIDE SUPERSCAN

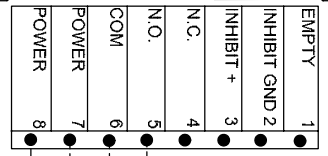

APPRCH SIDE SUPERSCAN

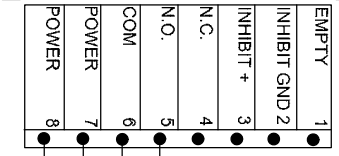

APPRCH SIDE SUPERSCAN

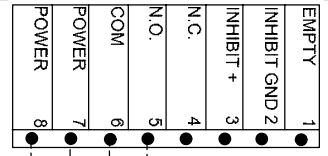

100 ENTERPRISE DRIVE
 PITTSBURGH, PA 15275
 PHONE: (412) 249-4100
 FAX: (412) 249-4101
 EMAIL: www.beasensors.com

TITLE: LE-21 WITH LO-21, BODYGUARD & SUPERSCANS

SIZE: A	DRAWN BY: KJG	REV BY: KJG	PART NO: 80.0025.02
	SCALE: NONE	DATE: 22 MAY 2005	SHEET 1 OF 1

NOTE: SWITCH MUST OPEN 10 DEGREES FROM DOOR CLOSING

IF AFTER TROUBLESHOOTING A PROBLEM, A SATISFACTORY SOLUTION CANNOT BE ACHIEVED, PLEASE CALL B.E.A., INC. FOR FURTHER ASSISTANCE DURING EASTERN STANDARD TIME AT 1-800-523-2462 FROM 8AM - 5PM. FOR AFTER-HOURS, CALL EAST COAST: 1-866-836-1863 OR 1-800-407-4545 / MID-WEST: 1-888-308-8843 / WEST COAST: 1-888-419-2564. DO NOT LEAVE ANY PROBLEM UNRESOLVED. IF YOU MUST WAIT FOR THE FOLLOWING WORKDAY TO CALL B.E.A., LEAVE THE DOOR INOPERABLE UNTIL SATISFACTORY REPAIRS CAN BE MADE. NEVER SACRIFICE THE SAFE OPERATION OF THE AUTOMATIC DOOR OR GATE FOR AN INCOMPLETE SOLUTION. WEB: WWW.BEASENSORS.COM

BODYGUARD



DK-12

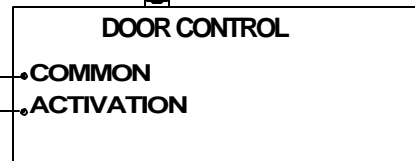
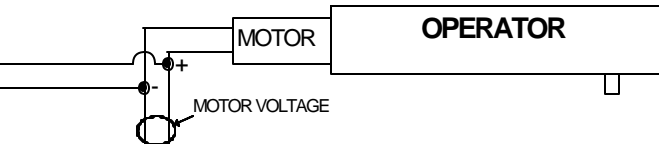
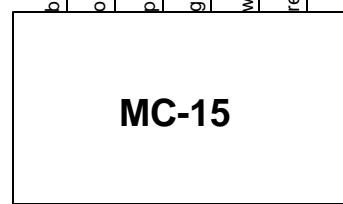
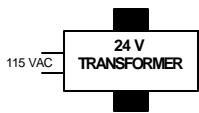
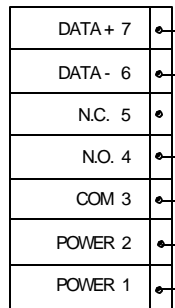

DOOR POSITION SWITCH

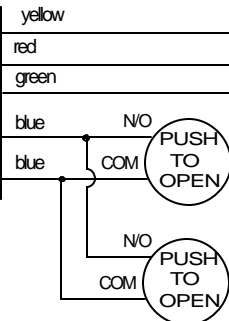
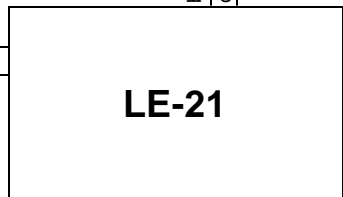
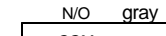

Closed contact when door is closed



B.E.A., Inc.

100 Enterprise Drive, Pittsburgh, PA 15275
PH: (412) 249-4100 FAX: (412) 249-4101

TITLE: LE-21 WITH MC-15, BODYGUARD, APPROACH SIDE SUPERSkans

SIZE: A	CAGE CODE:	DWG NO: 80.0031	FILE OF: ENG'G	DRAWN BY: JED	REV: 01
SCALE: NONE	DATE: 02 JAN 04	SHEET: 1 OF 1			

BODYGUARD



DK-12

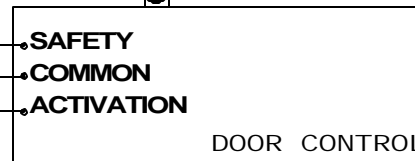
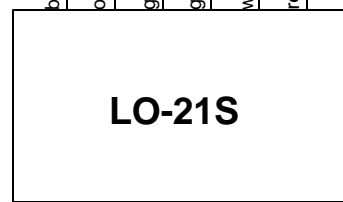
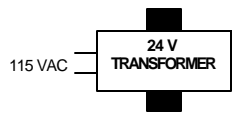
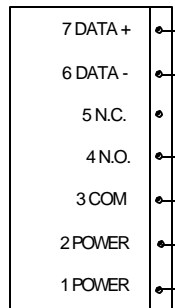

MOTOR VOLTAGE

DOOR POSITION SWITCH

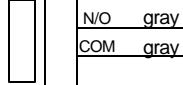

Closed contact when door is closed

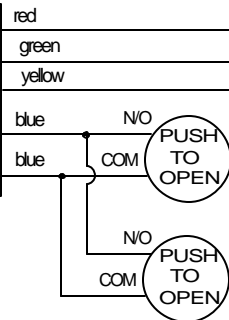
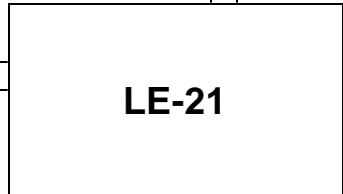

NOTE: 1) LO-21S IS WIRED INTO LE-21 TO ELIMINATE THE PUSH AND GO EFFECT.



B.E.A., Inc.

100 Enterprise Drive, Pittsburgh, PA 15275
PH: (412) 249-4100 FAX: (412) 249-4101

TITLE: LO-21S ACTIVATION WIRED TO LE-21 TO ELIMINATE PUSH-N-GO EFFECT

SIZE: A	CAGE CODE:	DWG NO: 80.0032	FILE OF: ENG'G	DRAWN BY: JED	REV: 01
SCALE: NONE	DATE: 02 JAN 04	SHEET: 1 OF 1			

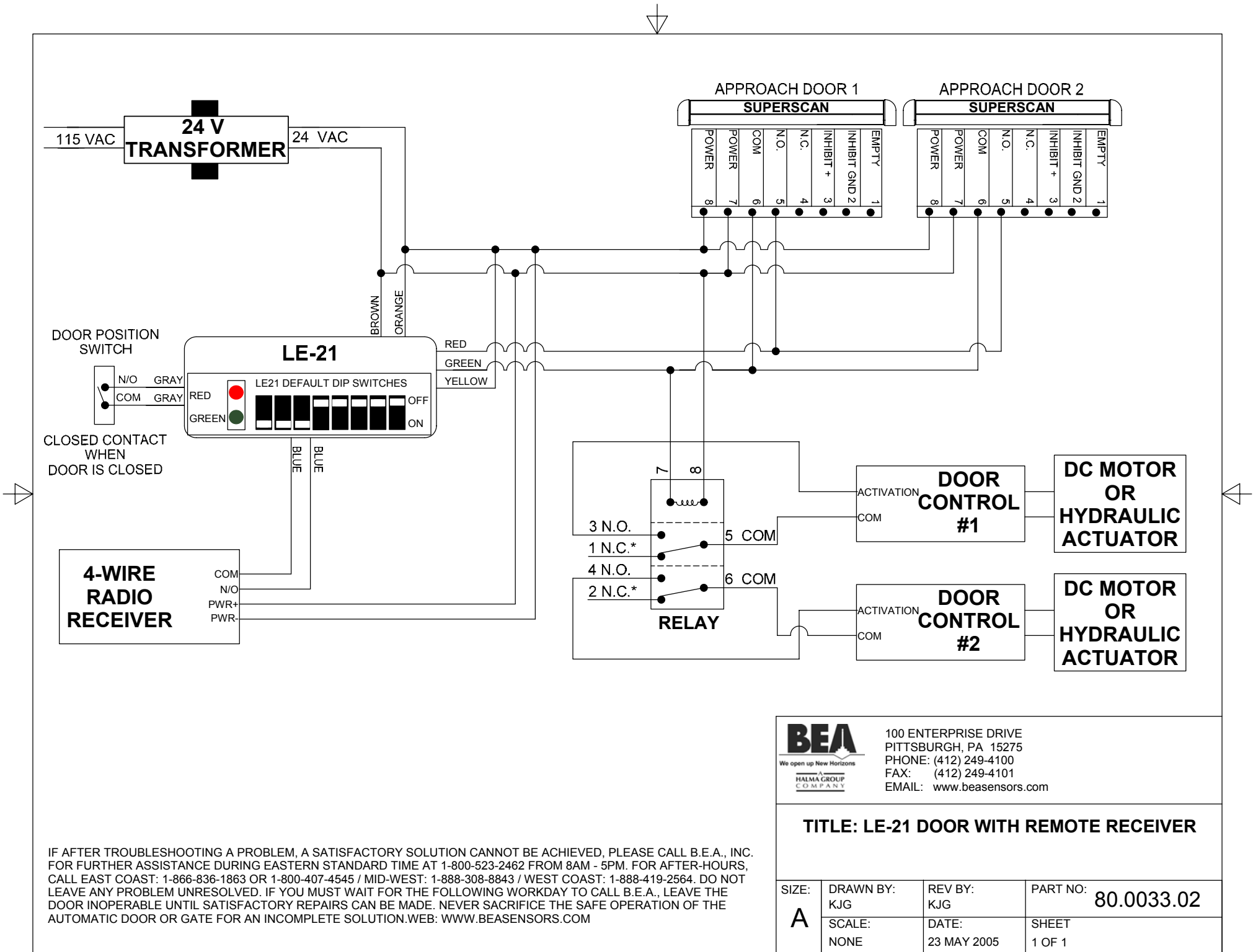

IF AFTER TROUBLESHOOTING A PROBLEM, A SATISFACTORY SOLUTION CANNOT BE ACHIEVED, PLEASE CALL B.E.A., INC. FOR FURTHER ASSISTANCE DURING EASTERN STANDARD TIME AT 1-800-523-2462 FROM 8AM - 5PM. FOR AFTER-HOURS, CALL EAST COAST: 1-866-836-1863 OR 1-800-407-4545 / MID-WEST: 1-888-308-8843 / WEST COAST: 1-888-419-2564. DO NOT LEAVE ANY PROBLEM UNRESOLVED. IF YOU MUST WAIT FOR THE FOLLOWING WORKDAY TO CALL B.E.A., LEAVE THE DOOR INOPERABLE UNTIL SATISFACTORY REPAIRS CAN BE MADE. NEVER SACRIFICE THE SAFE OPERATION OF THE AUTOMATIC DOOR OR GATE FOR AN INCOMPLETE SOLUTION. WEB: WWW.BEASENSORS.COM

BEA
 We open up New Horizons
 HALMA GROUP COMPANY
 100 ENTERPRISE DRIVE
 PITTSBURGH, PA 15275
 PHONE: (412) 249-4100
 FAX: (412) 249-4101
 EMAIL: www.beasensors.com

TITLE: LE-21 DOOR WITH REMOTE RECEIVER

SIZE: A	DRAWN BY: KJG	REV BY: KJG	PART NO: 80.0033.02
	SCALE: NONE	DATE: 23 MAY 2005	

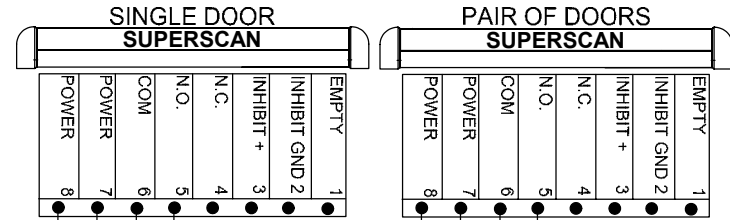

DOOR POSITION SWITCH

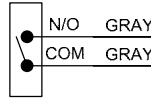

CLOSED CONTACT WHEN DOOR IS CLOSED

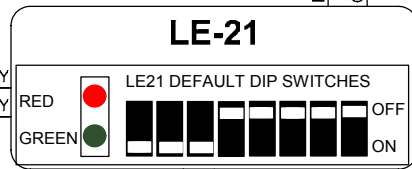

BLUE

BLUE

BROWN

ORANGE

RED

GREEN

YELLOW

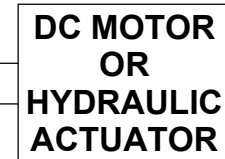
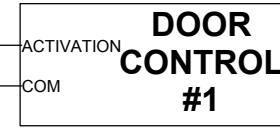

IF AFTER TROUBLESHOOTING A PROBLEM, A SATISFACTORY SOLUTION CANNOT BE ACHIEVED, PLEASE CALL B.E.A., INC. FOR FURTHER ASSISTANCE DURING EASTERN STANDARD TIME AT 1-800-523-2462 FROM 8AM - 5PM. FOR AFTER-HOURS, CALL EAST COAST: 1-866-836-1863 OR 1-800-407-4545 / MID-WEST: 1-888-308-8843 / WEST COAST: 1-888-419-2564. DO NOT LEAVE ANY PROBLEM UNRESOLVED. IF YOU MUST WAIT FOR THE FOLLOWING WORKDAY TO CALL B.E.A., LEAVE THE DOOR INOPERABLE UNTIL SATISFACTORY REPAIRS CAN BE MADE. NEVER SACRIFICE THE SAFE OPERATION OF THE AUTOMATIC DOOR OR GATE FOR AN INCOMPLETE SOLUTION.WEB: WWW.BEASENSORS.COM

100 ENTERPRISE DRIVE
PITTSBURGH, PA 15275
PHONE: (412) 249-4100
FAX: (412) 249-4101
EMAIL: www.beasensors.com

TITLE: LE-21 DOOR WITH REMOTE

SIZE: A	DRAWN BY: KJG	REV BY: KJG	PART NO: 80.0034.02
	SCALE: NONE	DATE: 23 MAY 2005	SHEET 1 OF 1

Free Manuals Download Website

<http://myh66.com>

<http://usermanuals.us>

<http://www.somanuals.com>

<http://www.4manuals.cc>

<http://www.manual-lib.com>

<http://www.404manual.com>

<http://www.luxmanual.com>

<http://aubethermostatmanual.com>

Golf course search by state

<http://golfingnear.com>

Email search by domain

<http://emailbydomain.com>

Auto manuals search

<http://auto.somanuals.com>

TV manuals search

<http://tv.somanuals.com>