

THE
BOSE®
ACOUSTIC WAVE®
MUSIC SYSTEM
SERIES II
OWNER'S
GUIDE

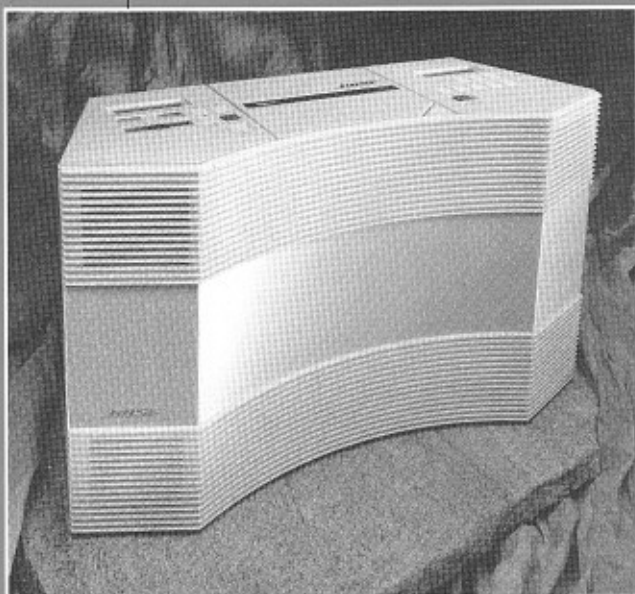

MODEL CD-2000

BOSE®

Warning

To reduce the risk of fire or electric shock, do not expose this system to rain or moisture.

Caution

To reduce the risk of shock, do not remove the cover of this system. There are no user-serviceable parts inside. Refer servicing to authorized service personnel.

The CAUTION marks shown on this page are located on the back of your system.



The lightning flash, with arrowhead symbol within an equilateral triangle, is intended to alert the user to the presence of uninsulated "dangerous voltage" within the system enclosure that may be of sufficient magnitude to constitute a risk of electric shock.



The exclamation point within an equilateral triangle as marked on the system is intended to alert the user to the presence of important operating and maintenance instructions in this owner's guide.



CAUTION: TO PREVENT ELECTRIC SHOCK, MATCH WIDE BLADE OF PLUG TO WIDE SLOT, FULLY INSERT.

ATTENTION: POUR ÉVITER LES CHOCS ÉLECTRIQUES, INTRODUIRE LA LAME LA PLUS LARGE DE LA FICHE DANS LA BORNE CORRESPONDANTE DE LA PRISE ET POUSSER JUSQU'AU FOND.

Safety instructions

Be sure to read these instructions first, before proceeding with the setup and connection of your Bose® Acoustic Wave® music system. Careful attention to safety will ensure the carefree use and long-lasting enjoyment of your new system.

- 1. Read Instructions** — Read all the safety and operating instructions before the unit is operated.
- 2. Retain Instructions** — Retain the safety and operating instructions for future reference.
- 3. Heed Warnings** — Adhere to all warnings on the unit and in the operating instructions.
- 4. Follow Instructions** — Follow all operating and use instructions.
- 5. Water and Moisture** — Do not use the unit near water — for example, near a bathtub, washbowl, kitchen sink, laundry tub, in a wet basement, or near a swimming pool.
- 6. Carts and Stands** — The unit should be used only with a cart or stand recommended by Bose Corporation.



a. The unit and cart combination should be moved with care. Quick stops, excessive force, and uneven surfaces may cause the unit and cart combination to overturn.

- 7. Ventilation** — Situate the unit so that its location or position does not interfere with its proper ventilation. For example, the unit should not be situated on a bed, sofa, rug, or similar surface that may block the ventilation openings.
- 8. Heat** — Situate the unit away from heat sources such as radiators, heat registers, stoves, or other appliances or direct sunlight.

9. Power Sources — Connect the unit to a power supply only of the type described in the operating instructions or as marked on the unit.

10. Polarization — The unit is equipped with a polarized alternating-current line plug (a plug having one blade wider than the other). This plug will fit into the power outlet only one way. This is a safety feature. If you are unable to insert the plug fully into the outlet, try reversing the plug. If the plug should still fail to fit, contact your electrician to replace your obsolete outlet. Do not defeat the safety purpose of the polarized plug.

11. Power-Cord Protection — Route the power supply cord so that it is not likely to be walked on or pinched by items placed upon or against it, paying particular attention to the cord at the plug, convenience receptacle, and the point where it exits from the unit.

12. Cleaning — Clean the unit only as directed by Bose Corporation.

13. Power Lines — Do not locate an outside antenna system in the vicinity of overhead power lines or other electric light or power circuits, or where it can fall into such power lines or circuits.

14. Outdoor Antenna Grounding — If an outside antenna or cable system is connected to this unit, be sure the antenna or cable system is grounded so as to provide some protection against voltage surges and built-up static charges. Section 810 of the National Electrical Code ANSI/NFPA No. 70-1984 provides information with respect to proper grounding of the mast and supporting structure, grounding of the lead-in wire to an antenna discharge unit, size of grounding conductors, location of antenna-discharge unit, connection to grounding electrodes, and requirements for the ground electrode.

Example of antenna grounding as per National Electrical Code

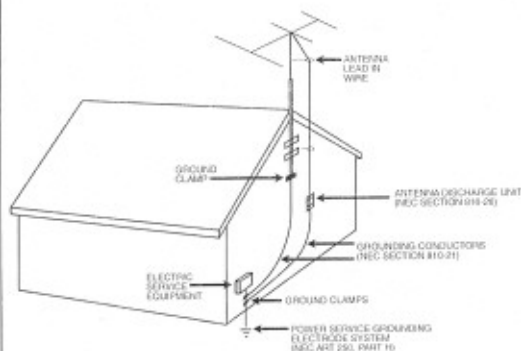

15. Nonuse Periods — Unplug the power cord of the unit from the outlet when left unused for a long period of time.

16. Object and Liquid Entry — Take care so that objects do not fall into and liquids are not spilled into the inside of the unit.

17. Damage Requiring Service — The unit should be serviced by authorized service personnel when:

A: The power-supply cord or the plug has been damaged; or

B: Objects have fallen, or liquid has been spilled into the unit; or

C: The unit has been exposed to rain; or

D: The unit does not appear to operate normally or exhibits a marked change in performance; or

E: The unit has been dropped, or the cabinet damaged.

18. Servicing — Do not attempt to service the unit in any way beyond those means described in the operating instructions. All other servicing should be referred to authorized service personnel.

CAUTION

If the addition of a cart or stand is desirable, the Acoustic Wave® music system should be used only with the AWMS Pedestal. Use of other stands may result in instability, causing possible injury.

Information

This equipment generates and uses radio frequency energy and if not installed and used properly, that is, in strict accordance with the manufacturer's instructions, may cause interference to radio and television reception. It has been type tested and found to comply with the limits for a Class B computing device in accordance with the specifications in Subpart J of Part 15 of FCC Rules, which are designed to provide reasonable protection against such interference in a residential installation. However, there is no guarantee that interference will not occur in a particular installation. If this equipment does cause interference to radio or television reception, which can be determined by turning the equipment off and on, the user is encouraged to try to correct the interference by one or more of the following measures:

- Reorient the radio or television receiving antenna.
- Relocate this equipment with respect to the radio or television receiver.
- Move this equipment away from the radio or television receiver.
- Plug this equipment into a different outlet so that equipment and radio or television receiver are on different branch circuits.

If necessary, the user should consult the dealer or an experienced radio/television technician for additional suggestions. The user may find the following booklet prepared by the Federal Communications Commission helpful:

"How to Identify and Resolve Radio-TV Interference Problems." This booklet is available from the U.S. Government Printing Office, Washington, DC 20402, Stock No. 004-000-00345-4.

NOTE: Unauthorized modification of the receiver could void the user's authority to operate this equipment. NOTE:

THIS DIGITAL APPARATUS DOES NOT EXCEED THE CLASS B LIMITS FOR RADIO NOISE EMISSIONS FROM DIGITAL APPARATUS AS SET OUT IN THE RADIO INTERFERENCE REGULATIONS OF THE CANADIAN DEPARTMENT OF COMMUNICATIONS.

LE PRÉSENT APPAREIL NUMÉRIQUE N'ÉMET PAS BRUITS RADIOÉLECTRIQUES D'ÉPASSANT LES LIMITES APPLICABLES AUX APPAREILS NUMÉRIQUES DE CLASSE B PRESCRITES DAN LE RÉGLEMENT SUR LE BROUILLAGE RADIOÉLECTRIQUE ÉDICTÉ PAR LE MINISTERES DES COMMUNICATIONS DU CANADA.

CAUTION

USE OF CONTROLS FOR ADJUSTMENTS OR PERFORMANCE OF PROCEDURES OTHER THAN THOSE SPECIFIED HEREIN MAY RESULT IN HAZARDOUS RADIATION EXPOSURE. THE COMPACT DISC PLAYER SHOULD NOT BE ADJUSTED OR REPAIRED BY ANYONE EXCEPT PROPERLY AUTHORIZED SERVICE PERSONNEL.

Contents

Introduction	6
Quick Reference Guide to your Acoustic Wave® music system	7-8
Plugging in your Bose® Acoustic Wave® music system	9
Adjusting the sound (CD Player and Radio)	10
Selecting the sound source	10
Using the radio	11-12
Using the Compact Disc (CD) player	12-13
Connecting and playing external components	14
Hookup instructions	14-16
Cleaning and caring for your Acoustic Wave® music system	17
Warranty information	17
Acoustic Wave® music system accessories	17
In case of difficulty	18-19
About your Acoustic Wave® music system	20
About Bose® Corporation	20

Introduction

Thank you for purchasing the Bose® Acoustic Wave® music system Series II (AWMS). This compact, portable unit houses state-of-the-art electronics that will provide you with the quality high fidelity sound usually associated only with larger component systems. Your Acoustic Wave® music system is designed for easy use and handling. Its attractive, contemporary styling will be at home in virtually any room decor.

In addition to playing the built-in compact disc player and AM/FM radio, you can enjoy your AWMS in a variety of other ways. Use it to complement other components such as VCR's, video disc players, televisions, and musical instruments. Or, add any of the optional Bose accessories for greater versatility. For example, the Bose Power Microphone allows you to use the AWMS as a portable P/A system or, for added fun, to sing along with the music while it is playing. With the Bose Power Cord, you can use your AWMS in your car or recreational vehicle. The Bose Power Case and Power Pack let you carry your system easily and enjoy lifelike sound anytime, anywhere — even without an electrical outlet!

Even though your AWMS is simple to operate, we urge you to read this guide first. The information provided will help you understand all of the features of your Acoustic Wave® music system and enable you to enjoy it for many years.

The Quick Reference Guide on the following pages will acquaint you with the location and functions of each of the controls and connections on your system.

Quick Reference Guide to your Acoustic Wave[®] music system

Sound Controls

(Figure 1)

- A. BASS CUT/TREBLE CUT** — adjusts the balance of low notes (bass) to mid-range and high notes (treble); for CD player and radio
- B. VOLUME** — adjusts the loudness (volume) of system; for CD player and radio
- C. INPUT** — allows you to hear a connected external source when pushed down and locked into the AUX position

Compact Disc (CD) Player Controls

(Figure 1)

- D. PLAY/PAUSE** — starts/pauses/resumes disc playing
- E. STOP** — ends disc playing
- F. SKIP** — jumps forward (>>) or backward (<<) one track

- G. Display Window** — displays current operating status of compact disc player
- H. OPEN** — opens CD player's lid for inserting and removing discs

Radio Controls

(Figure 1)

- I. RADIO-AUX ON/OFF** — turns the radio on and off; also turns the AWMS power on and off for playing an auxiliary component through the system
- J. AM/FM** — chooses between AM and FM reception
- K. TUNE/SEEK** — scans up and down the frequencies to select desired station
- L. 1-5** — selects a preset AM or FM station
- M. Display Window** — displays selected station

NOTE: The display windows will remain lit as long as your AWMS is connected to an electrical source. They will not light if the unit is being battery powered.

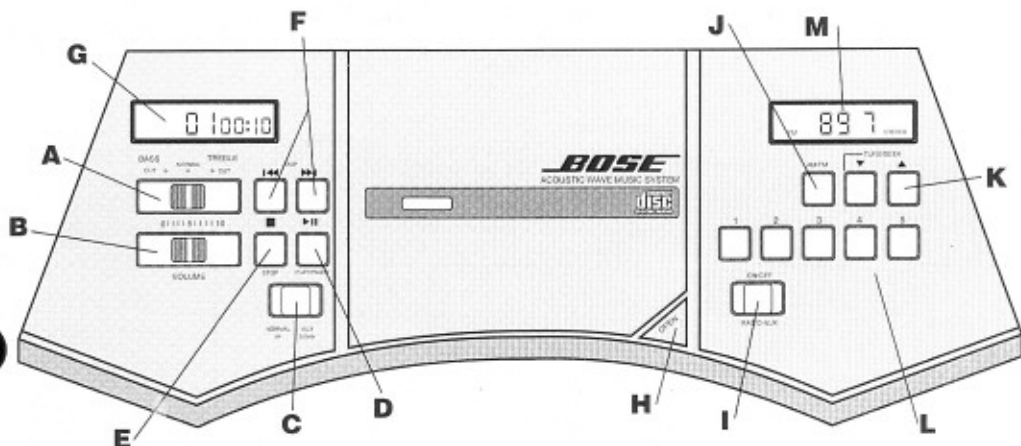

Figure 1

Connections and Antennas

(Figure 2)

- N. FM Antenna** — receives FM signals
- O. AC/DC** — lets you choose the power source, either AC (for example, 120V, 60Hz in North America) or 12V or 15V DC (with optional Bose Power Cord DC adapter)
- P. External FM Antenna** — connection for an external FM antenna
- Q. LINE OUT** — lets you send music from your AWMS to another component for recording or playback
- R. MIC** — allows you to connect the optional Bose Power Microphone for voice-over operation
- S. AUX. IN** — connection for an external component to play through your system
- T. Line Cord** — provides AC power to the AWMS

Additional Features

(Figure 2)

- U. Molded Cutouts** — for convenient transport
- V. Ventilation Slots** — for system cooling (CAUTION: Do not insert fingers or allow items such as paper clips to be inserted into the ventilation slots)

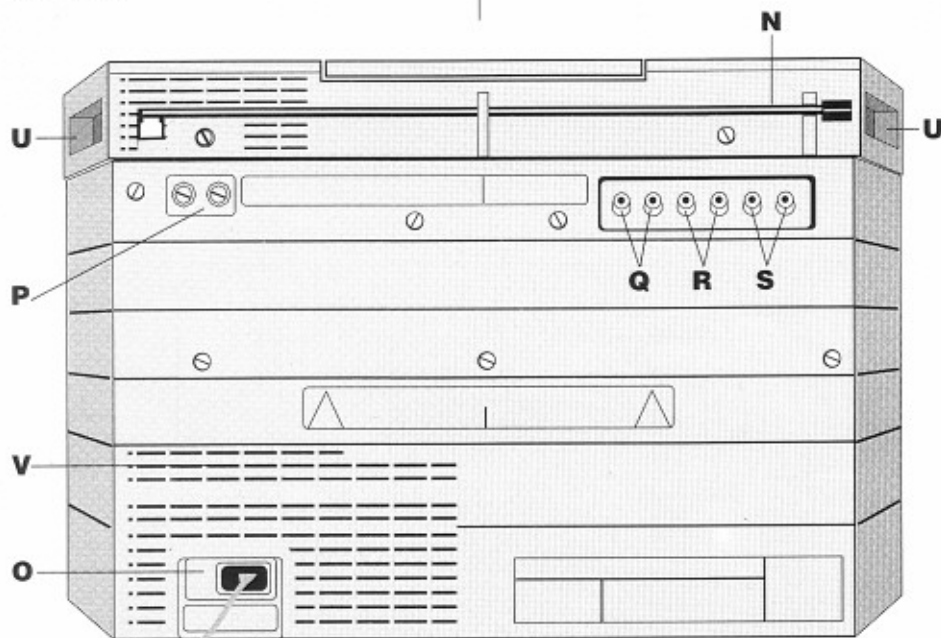

Figure 2

Plugging in your Bose Acoustic Wave[®] music system

To an Outlet

To connect your system to a standard wall outlet (e.g., 120 volts in North America), slide the AC/DC switch to the AC position to expose the AC power jack (Figure 3). First plug the small end of the power cord into the AWMS power jack, and then plug the large end of the cord into the wall outlet.

To a Cigarette Lighter Socket (with the optional Bose Power Cord)

You can plug your AWMS into the cigarette lighter socket of your car or recreational vehicle using the optional Bose Power Cord 12V-15V adapter (PN124998). Slide the AC/DC switch to the DC position to expose the DC power jack (Figure 4). First insert the small end of the connector cord into the AWMS power jack, and then insert the large end of the cord into the lighter socket. **IMPORTANT:** Use only the Bose Power Cord with your AWMS. Using other adapters could result in damage.

To the Optional Bose Power Pack or Bose Power Case

Your AWMS can be played almost anywhere when connected to the battery of the Power Pack (Model PK-1) or to the battery pack in the Power Case (PN 129601). See accessories section of this manual for more information. Follow the instructions supplied with each accessory for making connections.

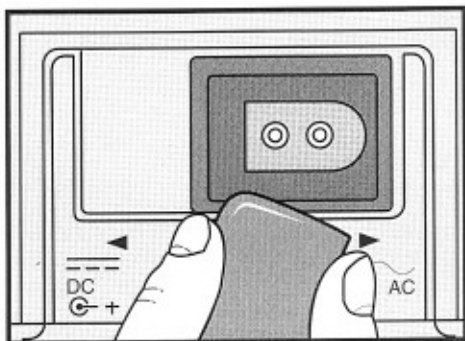

Figure 3

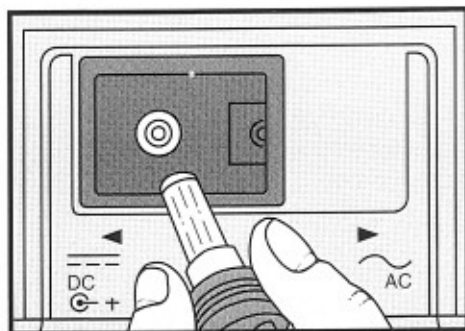

Figure 4

Adjusting the sound

(CD Player and Radio)

VOLUME control

(Figure 5)

To increase the volume, slide the control to the right. To decrease the volume, slide the control to the left.

BASS CUT/TREBLE CUT control

(Figure 5)

When set at the center (NORM) position, the AWMS delivers the "normal" balance of bass (low notes) to treble (high notes). You may adjust this control, if you want, to compensate for the type of music and listening environment variants, as described in the "Room Acoustics" section below. Sliding the control to the right decreases the amount of treble sound. Sliding the control to the left decreases the amount of bass sound.

Room Acoustics

In any room, sound reflects from the walls, floor, and furniture. Soft furnishings tend to absorb sound and hard furnishings tend to reflect sound. Some rooms create an excess of bass, others, an excess of treble.

As with any high quality stereo system, the position of your AWMS in the room will also affect its sound. For best results, place your system so that it is at ear level when you are listening. The AWMS will produce the most bass when placed on a solid surface (such as a sturdy table) in a corner of the room.

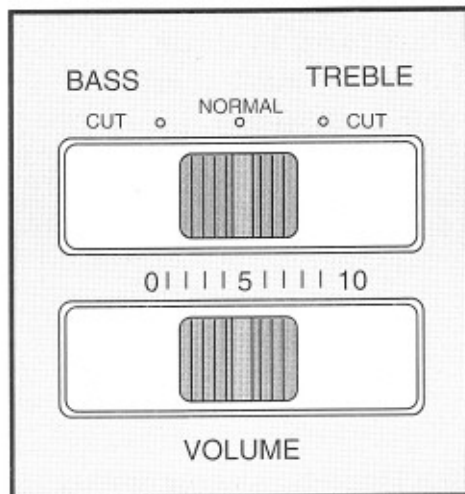

Figure 5

Selecting the sound source

The INPUT button prepares your system for playing a particular sound source. To listen to your AWMS compact disc player or radio, set the button in the NORM (up) position. To listen to an external component, use the AUX (in) position. If the INPUT button is not set correctly, you may not hear any sound.

NOTE: The INPUT button does not begin playing the selected source. You must press PLAY to operate the CD, or push the RADIO-AUX ON/OFF button to the ON position to play the radio or an auxiliary component.

Using the radio

Turning the radio on and off.

To turn the radio on, press the maroon RADIO-AUX ON/OFF button. (Make sure the INPUT selector is in the NORM (up) position.) The display above the radio controls will display the currently tuned band (AM/FM) and station frequency number (Figure 6).

NOTE: If the system has been turned on after having been unplugged (or without power) for more than an hour, the radio display will read 530AM when turned on, and you will need to tune the radio to the desired station.

Press the RADIO-AUX ON/OFF button again to turn the radio off.

Changing from AM to FM

Press the AM/FM button. The selected band will appear in the display above the radio controls.

Tuning to a station

Use the up (^) or down (v) TUNE / SEEK buttons to select a station in one of the following ways:

- Press and release the desired button to move the tuner up or down one step (e.g., from 89.7 to 89.9). (There may not be a station on a particular step.)
- Press and hold the desired button down until you hear a beep, then immediately release the button. This moves the tuner to the next (or previous) station.
- Press and hold the desired button to move the tuner rapidly up or down through the stations, then release to stop the tuner.

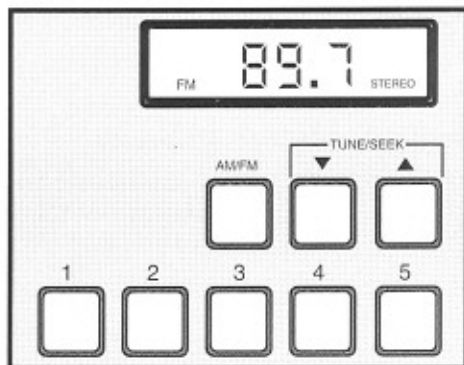

Figure 6

Storing stations in memory

Tune to the desired station using the TUNE / SEEK buttons. Press one of the buttons labeled 1-5 (Figure 6) and hold it down until you hear a beep. Release the button. The station displayed on the screen is now remembered by the button you have selected. Each button can memorize one AM and one FM station, allowing you to preset up to ten radio stations (five AM and five FM) for instant tuning.

To replace a preset station with a new station, simply repeat the above procedure. The new station will automatically replace the old one.

NOTE: If you unplug your AWMS or if there is a power outage, preset stations will remain in memory for about one hour. If power is not restored within an hour (i.e., you do not replug the system, connect it to a battery power source, or the power outage continues), you must reprogram the desired stations to memory when power is restored.

Tuning to a preset station

Press the button (1-5) that corresponds with the desired preset station.

Using the AM/FM Antennas

An internal antenna receives AM stations. Select a station and then rotate your AWMS, if necessary, until you get the best reception.

The telescopic antenna on the top rear of the unit receives FM frequencies. For FM listening, extend the antenna and then rotate it to get the best reception. The antenna is designed to move left and right freely. To move the antenna back and forth, you must first rotate it 90 degrees.

Using the Compact Disc (CD) player

NOTE: Before using the compact disc player, make sure the INPUT selector is in the NORM (up) position.

The CD player operates independently of the radio operation; the radio does not need to be on for the CD player to function. All controls for the CD player are located on the top left of your AWMS. Use the VOLUME and BASS CUT/TREBLE CUT controls to adjust the sound of the music.

 Only those compact discs with the symbol shown at the left can be played with this unit. Any other type of disc cannot be played.

Dirt, dust, scratches, or warping can affect a compact disc and result in noise or other malfunctions. Please take precautions to avoid this.

The laser beam used in this compact disc player can be harmful to eyes. Do not attempt to disassemble the casing. Refer servicing to qualified personnel only.

CAUTION: Do not directly touch the laser pickup in the disc tray (Figure 7) with your fingers. If the lens surface of the laser pickup becomes dirty or damaged, correct CD playback will become impossible. To protect the laser pickup from damage, be sure to keep the top cover closed except when you are loading and unloading discs.

If a solid object or any liquid falls into the player, disconnect the power source immediately and have the player checked by qualified personnel before further operation.

Condensation: In some instances, if condensation forms inside the CD player, water droplets on the pickup lens or unit may cause malfunctions. This might occur when:

1. The unit is in an initially cold room that is warmed up rapidly.
2. The unit is moved from a cold location to a warm location.
3. The unit is used in a room full of steam or moisture.

Depending on ambient conditions, such condensations will normally evaporate if the unit's power is switched on and left on for about an hour. If there is any indication that condensation may have formed, remove the disc and leave the system turned on for about one hour before use.

For the unit to operate at its best, it should not be subjected to temperatures below 41°F (5°C) or above 95°F (35°C).

Any jostling or tilting that occurs while moving the unit may cause a temporary interruption in play.

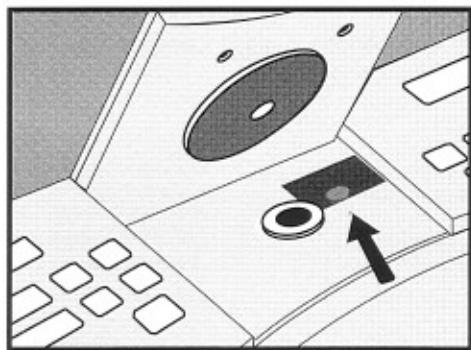

Figure 7



Figure 8

Inserting/Removing a Compact Disc

Press and release the OPEN button in the lower right-hand corner of the compact disc player. The lid will pop up. Place the disc gently over the spindle (Figure 8) label side up. Close the lid by pressing it down until the latch clicks. The CD player will not operate with the lid open.

Reverse the above procedure to remove the disc after playing has stopped.

NOTE: You cannot harm the disc if you place it upside down. However, it will not play. Always handle discs by their edges only, to avoid leaving fingerprints on the data surface. Store CD's vertically in their cases, away from heat or direct sunlight.

Playing a Compact Disc

To begin playing the disc, press the maroon PLAY/PAUSE button. The track number and the elapsed playing time will show in the display window above the controls to the left of the CD player.

To pause while playing, press the PLAY/PAUSE button. To resume playing where you left off, press the PLAY/PAUSE button again. You can repeat this procedure as often as desired while the disc is playing.

NOTE: To view the total playing time of the disc, press PLAY and then press STOP. The playing time will display for a few seconds. Press PLAY again to resume playing.

To skip ahead one track, press the SKIP >> button once. The next track will begin to play. The display will change to show the next track and the new track's elapsed time. To skip ahead more than one track, press the button as many times as necessary.

To skip back to the beginning of the current track, press the SKIP << button once. Repeat to skip back more than one track.

To stop playing the disc, press the STOP button.

Connecting and playing external components

You can connect another component such as a VCR to play through your AWMS by connecting it to the AUX. IN jacks on the back of your system (Figure 9). Most audio and video components will connect directly to your AWMS and require only a cable with a standard RCA connector at one end (to attach to the AWMS) and a plug compatible with the other component at the other end. The only exception is a turntable, as described later in this section.

The set of input jacks labeled MIC has been provided so that you may use the Bose® Power Microphone to sing along with the music while it is playing.

The LINE OUT jacks let you play music from your AWMS through an external component, or record onto an external tape deck.

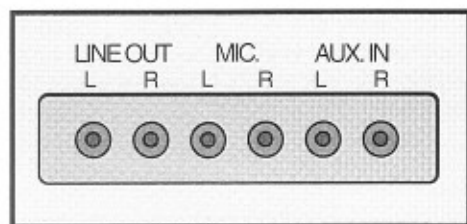

Figure 9

Playing An External Component

To play an external component through your AWMS:

1. Press the INPUT button down to the AUX position.
2. Press the RADIO-AUX ON/OFF button down to turn the AWMS power on.
3. Turn on the external component.

Hookup instructions

VCR, Video Discs

The Acoustic Wave® music system's high fidelity brings extra realism to all video sources, both stereo and mono. (Note that even though mono sources are greatly enhanced through your AWMS, their sound will still be in mono.) Virtually all VCR and video disc devices have an output that is compatible with your AWMS even if the device is not stereo. Make sure you use a cable that is compatible with the device.

If your VCR or video disc system has a single (mono) audio output jack, use the supplied "Y" adapter to make sure that both the left and right channels of your AWMS get sound. Plug the single "Y" adapter end into the single end of the VCR output, and the double "Y" end into the corresponding end of the supplied patch cord. Insert the other end of the patch cord into the AUX. IN jacks on your AWMS (Figure 10). If your VCR has a headphone jack, you can use it to play your VCR through your AWMS.

If your VCR is stereo, connect it to your AWMS the same way as you would any other stereo component (Figure 11).

To make sure that the sound seems to come from the screen area, place your AWMS close to your VCR/TV setup. Do not, however, place your AWMS on top of your VCR or television. The magnets in your system's speakers may interfere with the picture on your TV or accidentally erase your tapes. Likewise, do not place your AWMS directly next to video or audio tapes.

Television

Connecting your television to your AWMS adds high fidelity to your TV's sound. If your television has a single (mono) audio output jack, use the supplied "Y" adapter to make sure that both the left and the right channels of your AWMS get sound (Figure 10). If your television has an earplug output, a special earplug adapter may be required. If your television has stereo output jacks, a standard RCA cord is usually all that is required (Figure 11).

For best results, place your AWMS close to your television to make sure that the sound seems to come from the screen area. Do not, however, place your AWMS on top of your television. The magnets in your system's speakers may interfere with the picture on your TV.

Tape Deck

You can connect an external tape deck to your AWMS and record onto it from your AWMS CD player or radio. Use standard RCA cords to connect the AUX. IN jacks of your AWMS to the LINE OUT jacks of your tape deck, and to connect the LINE OUT jacks of your AWMS to the LINE IN jacks of your tape deck (Figure 9).

Turntable

You can connect your turntable to play through your AWMS system. Most turntables usually require the addition of a special preamplifier (such as Realistic's Item Number 42-2109, available at Radio Shack). You can buy phono preamplifiers at most electronic accessories department. They connect easily between your turntable and your AWMS with standard RCA cords. Ask your Bose® representative for assistance, if necessary.

Bose Power Microphone

You can use your AWMS as a mini public address system by plugging a Bose Power Microphone (Model PM-10, available from your Bose representative) into the AUX. IN jacks (Figure 9). When connected this way, you will hear voice only. If you plug the Power Microphone into the jacks labeled MIC, you get voice-over capabilities instead; this means that you can sing along with the music while it is playing on your AWMS.

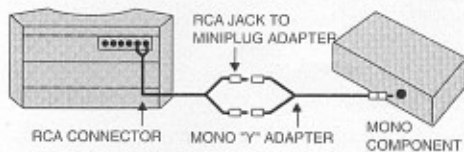

Figure 10

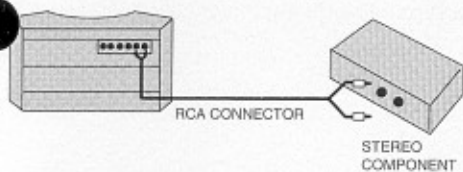

Figure 11

Musical Instruments

You can play keyboards and other instruments through your AWMS to get full high fidelity sound. A preamplifier may be needed for certain instruments such as electric guitars. Your music equipment dealer or Bose® representative can assist you.

NOTE: Although your AWMS can be used to amplify musical instruments and voice, it is not intended as a substitute for a heavy duty professional sound system.

Multiple Hookups

The AWMS Pedestal (Model PD-2) allows you to connect multiple external components to your system at one time. Ask your Bose representative for details.

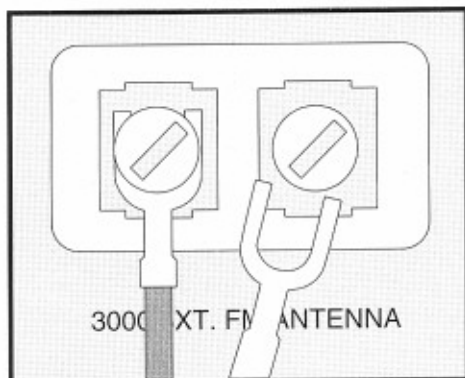

Figure 12

External FM Antenna

In most cases, your system will provide good reception with its telescopic FM antenna. However, if you are experiencing weak signals or excessive noise, you may want to connect an external FM antenna. Be sure to use a 300-ohm antenna system.

To make the connections, loosen the EXTERNAL ANTENNA screw terminals on the back of your AWMS with a screwdriver (Figure 12). Connect the wire leads from your external antenna beneath the screws and retighten the screws firmly. If you are unsure about your antenna system, or if you have any problems with FM radio reception, contact your Bose representative.

FM Cable

If your cable television system carries FM radio, you may connect your AWMS to your cable system; special adapters may be needed. Contact your cable television representative for more information.

Cleaning and caring for your Acoustic Wave® music system

Before cleaning your AWMS, unplug it from the AC or DC power supply. Then, wipe the system with a damp cloth and let it dry. Do not immerse your AWMS in water, or spray any cleaners directly onto the system.

Clean the CD player lens carefully, only if necessary, as follows:

If the lens is dusty, blow the dust away using a cold blower or camera lens brush. If a fingerprint is on the lens, wipe it gently with a lens tissue moistened with lens cleaning solution. These items are available from your local camera store dealer.

- Apply a very small amount of the lens cleaning solution to the tissue. Make sure that no lens cleaning solution enters the unit; it may cause damage.
- Do not apply excessive pressure on the lens, which could be damaged.

For outdoor use, we recommend that you use the optional Bose® Power Case to help protect your system from sand, dirt, moisture, and direct exposure to sunlight. Contact your Bose representative for details.

Warranty information

If your system fails to work after trying the suggestions in the "In Case of Difficulty" section, have it serviced by authorized personnel only. For complete warranty information on your Bose Acoustic Wave® music system, including instructions on returning the AWMS for servicing, please consult the Warranty Registration Card included with your system. Should your AWMS require servicing during the warranty period, Bose Corporation will make every effort to remedy any problem within the terms of the warranty at minimum inconvenience to you.

Acoustic Wave® music system accessories

The following Bose accessories are available specifically for use with your Acoustic Wave® music system: Power Cord (DC adapter), Power Pack (rechargeable battery), Power Case, AWMS Pedestal, and Power Microphone. Contact your Bose representative for more information.

In case of difficulty

Most often, any problems you may experience with your Acoustic Wave® music system will be relatively minor. You may be able to easily correct them yourself. If you have one of the following problems, try the suggested solutions first, before contacting your Bose® representative.

System is on, no sound.

Possible Reason/Solutions:

- Input selector improperly set.
Check input setting (NORM or AUX).

System doesn't turn on.

Possible Reason/Solutions:

- Power cord unplugged or improperly connected. Check cord and connection.
- If hooked up to the Bose Power Case or Bose Power Pack, batteries may be weak. Replace or recharge batteries as necessary.

Preset radio stations are not tuned when buttons 1-5 are pressed.

Possible Reason/Solutions:

- Your AWMS has been disconnected from a power supply for more than one hour. When power is restored, reset the stations to memory.

CD does not play.

Possible Reason/Solutions:

- CD may be inserted improperly, or door may be open. Make sure CD has been inserted correctly (with the label side up), the lid to CD player is fastened shut, and unit is in play mode.
- Condensation that may have formed inside the CD player can cause malfunctions. Switch the unit's power on and leave it on for about an hour, to allow possible condensation to evaporate.
- Jostling or tilting may interrupt CD play. Make sure the unit is secure and level.

Poor CD quality when unit plays.**Possible Reason/Solutions:**

- CD may be dusty or defective; clean disc with a commercially available disc cleaning cloth, wiping from the center out.
- Lens surface of the laser pickup may be dirty or dusty. If dusty, blow the dust away using a cold blower or a camera lens brush (available from your local camera store dealer). If a fingerprint is on the lens, apply a very small amount of lens cleaning solution onto a lens tissue (also available from your local camera store dealer) and very gently wipe the lens. To avoid damaging the lens, *do not apply excessive pressure. Do not allow any lens cleaning solution to enter the unit; it may cause damage.*
- Vibrations may occur if the unit is played too loudly. Lower the volume.

Poor AM reception.**Possible Reason/Solutions:**

- Rotate your AWMS to get the strongest reception on the internal AM antenna.

Poor FM reception when using the telescopic FM antenna on the back of the AWMS.**Possible Reason/Solutions:**

- You may live in an area with generally poor reception. Make sure the FM antenna is fully extended. If you still have problems, connect your AWMS to an external FM antenna as explained on page 16 of this guide.

Weak sound at maximum volume while playing from an external source.**Possible Reason/Solutions:**

- The external source's volume control may be turned down too far, or a preamplifier may be necessary. Refer to the "Connecting and playing external components" section beginning on page 14.

Poor sound quality from an external component (tape deck, TV, etc.)**Possible Reason/Solutions:**

- The signal from some components is too strong or too weak for good sound quality. If possible, adjust the volume level on the external component.

About your Acoustic Wave[®] music system

Fourteen years of research and millions of dollars were required to develop the technology behind the Acoustic Wave[®] music system. Your AWMS employs a unique device for producing high fidelity sound from a small enclosure (Figure 13). Its waveguide functions like a pipe organ by precisely controlling a small volume of air and amplifying it to produce a loud sound. Unlike a single pipe from an organ, however, which is tuned to a single frequency, the patented AWMS waveguide is tuned to a wide range of frequencies. The waveguide enclosure, in combination with the precise placement of the bass speaker, produces the required air velocity and reduction in speaker cone motion that enables the AWMS to produce rich, high fidelity bass without bulky components. Additionally, patented Dynamically Equalized[™] circuitry within this system allows you to enjoy rich, full bass at low volumes, without the audible distortion common to other systems. The Acoustic Wave[®] music system is the first product to incorporate these technological milestones.

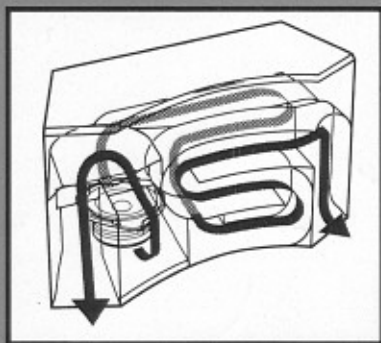

Figure 13

About Bose[®] Corporation

Research initiated in 1956 at the Massachusetts Institute of Technology (MIT) led to the formation of Bose Corporation, which was founded in 1964 to design, manufacture, and market quality audio products. Today, Bose has one of the most advanced speaker manufacturing and acoustics research facilities in the world.

Bose Corporation is dedicated to producing home high fidelity systems, music systems specifically designed and manufactured for some of the finest automobiles and televisions in the world, and products for professional sound applications. Each Bose product incorporates the results of extensive research performed under the direction of Dr. Amar G. Bose, founder and chairman of Bose Corporation. In addition, Dr. Bose is a professor of electrical engineering and computer science at MIT.

At Bose, building better products is a science. That's why, when quality sound is important, Bose products are essential.

BOSE[®]
Better sound through research.

©Copyright 1991 Bose Corporation
The Mountain, Frammingham, MA 01701-9168 USA
Telephone: 508-879-7330 Facsimile: 508-872-8541
Bose products are distributed worldwide.

Product features and specifications subject to change without notice
Covered by patent rights issued and/or pending. Bose and Acoustic Wave are registered trademarks of Bose Corporation. 626
P#142149 - Rev 1

Free Manuals Download Website

<http://myh66.com>

<http://usermanuals.us>

<http://www.somanuals.com>

<http://www.4manuals.cc>

<http://www.manual-lib.com>

<http://www.404manual.com>

<http://www.luxmanual.com>

<http://aubethermostatmanual.com>

Golf course search by state

<http://golfingnear.com>

Email search by domain

<http://emailbydomain.com>

Auto manuals search

<http://auto.somanuals.com>

TV manuals search

<http://tv.somanuals.com>