

Portable Air Conditioner Instruction Manual

BRADDA



YPL3-08C

Please read the instructions completely before using this product
This product is designed for household use only.



FOR SERVICE : CALL TRANS GLOBAL SERVICE 1-800-360-2742

CONTENT

INTRODUCTION.....	2
SAFETY.....	5
INSTALLATION.....	6
PART NAME.....	7
CONTROL PANEL.....	9
REMOTE CONTROL.....	10
OPERATION METHODS.....	11
WATER DRAINAGE.....	12
MAINTENANCE.....	12
TROUBLESHOOTING.....	13

INTRODUCTION

Thank you for choosing Our Portable Air Conditioner. Please read this manual carefully before using this product.

The following tips may help to maximize the efficiency of your air conditioner:

- When the air conditioner is on, keep doors and windows closed.
- Turn off kitchen or bathroom exhaust fans when your air conditioner is on.
- Operate the unit in recommended room size.
215 sq.ft. (20sq.m) for 8,000 BTU
- Turn off the air conditioner when you leave home.
- Check the filter monthly and keep it clean.
- Do not place anything that may generate heat near the thermostat or the air conditioner may run longer then necessary.
- Keep blinds and curtains closed during hot weather.
- Avoid blocking the air vents.

SAVE THESE INSTRUCTIONS FOR FUTURE REFERENCE

IMPORTANT SAFEGUARDS

When using electrical appliances, basic safety precautions should always be followed:

1. Read all instructions
2. To protect against fire, electric shock and personal injury, do not immerse cord, plugs, or the unit in water or other liquid.
3. Close supervision is necessary when the product is used around the children. This product is not intended for use by children.
4. Do not operate the product with a damaged cord/plug. If the plug is damaged in any manner, please return the product for repair.
5. Always keep the product in an upright position.
6. During the transit, the product could be placed upside **down**, which may cause the oil in the compressor drain into the refrigerant tubes reducing the cooling efficiency. Thus, before using the product, keep the product in a upright position for 1~2 hours.
7. Connect the product to a properly grounded power supply. Do not use an adapter plug or extension cord.
8. Do not cover or insert any object into the air inlet and/or outlet.
9. Turn off the power when no one is in the room.
10. Do not place anything in the direct path of the airflow.
11. Do not place the product near any heat source or where gas leakage may occur.
12. Do not use the product near a bath, shower, or swimming pool, or in any **wet environment**.
13. Do not turn off/on the product by plugging or unplugging the power cord directly.
14. Do not modify the power cord or share the outlet with other appliances.
15. Unplug the product from the outlet when not in use and before cleaning.
16. **Do not use** attachments not recommended by the manufacturer as they may cause injuries.
17. Do not expose skin, face and eyes directly to cool air for a long period of time.
18. If an abnormal odor or smoke comes from the product, disconnect the unit immediately and bring to a qualified service technician.
19. Unplug the power from wall outlet before cleaning the filter and do not touch the metal parts inside.
20. Do not apply any kind of insecticide or flammable spray onto or into the unit.
21. Do not step on the product or place objects on the unit.
22. Place the product on a steady and flat surface, or the water may **leak** out of the water tank.
23. Before storing the product, always drain the water from the unit and clean the filter.
24. Do not use the product for other than its intended use.

The manufacturer disclaims any responsibility if the above instructions are not followed.

The manufacturer reserves the right to make technical changes without notice.

SAVE THESE INSTRUCTIONS

This product is designed for household use only

LCDI POWER CORD AND PLUG

This air conditioner is equipped with an LCDI (Leakage Current Detection and Interruption) power cord and plug. The LCDI power cord and plug will shut off the supply source via electrical disconnect (circuit trip) if the nominal current leakage between the cord shield and either load conductor exceeds a predetermined value. The cord will not be able to conduct power until the device has been manually reset. This device provides protection to reduce the risk of fire due to arcing faults in the power cord. The cord shields are not grounded and they must be considered as shock hazards if exposed. The cord shield must not be connected to ground or to any exposed metal.

To ensure if the plug is working properly, please follow the following instructions to test it:

1. Plug power cord into wall outlet.
2. Press TEST button. The circuit should trip, cutting power to the air conditioner.
3. Press RESET button for use.

DO NOT USE IF ABOVE TEST FAILS.

In the event the LCDI Plug of the power cord trips by itself, then first examine the cord for any damage. If there is no damage to the cord, then press the RESET Button. If the LCDI Plug trips again, then immediately unplug the power supply cord and contact a professional technician or service center.

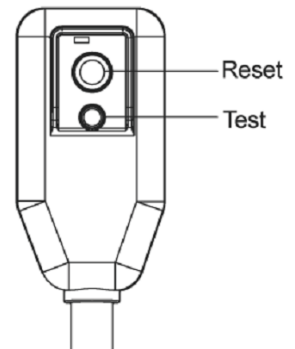

WARNING:

1. Do not use the TEST and RESET buttons as "ON" and "OFF" switches.
2. Do not press the TEST button while the air conditioner is operating
3. The cord and plug are designed for indoor use only.
4. Periodically examine the cord for any damage. If the shield gets exposed, immediately unplug the power cord and do not use the unit.

SAFETY

PLEASE READ ALL THESE INSTRUCTIONS CAREFULLY BEFORE USING THIS APPLIANCE

- Only use this appliance for domestic purposes and in the way indicated in these instructions. Never use for any other purposes.
- Do not use the appliance outside and always place it in a dry environment.
- From time to time, check the cord. Never use the cord, the plug or the appliance when they show any sign of damage. The cord length of this product has been selected to reduce the possibility of being injured. Do not use your appliance with an extension cord unless it has been checked and tested by a qualified electrician or electrical supplier.
- Keep the appliance away from hot sources and direct sunlight.
- Always switch off the appliance before unplugging it.
- Unplug the appliance before cleaning or changing any parts of the appliance or when it's not in use.
- Clean the appliance according to manual.
- Make sure that the voltage rating on the type plate corresponds to your main voltage. Any error in connecting the appliance invalidates the guarantee.
- Never leave the appliance unsupervised when in use. Switch off the appliance if you have to go away for even a short time.
- Never pull the cord to unplug or move the appliance.
- Never immerse the appliance in water or any other liquid for any reason.
- Keep the appliance away from water or oil splashes.
- Respect the instructions for cleaning.
- Do not insert sharp metallic objects or fingers in the air swinging fins of the appliance.
- Never repair the appliance yourself. All interventions made by a non-qualified person can be dangerous. As well any changing of the cord must be done by a qualified electrician.
- Never use accessories non-delivered by the supplier. This could be dangerous and could damage the appliance.

Special recommendations:

- Install the portable air conditioner on a flat location with a large space, without obstacles. Leave a 50cm minimum space between the unit and the wall.
- The plug shall be always accessible after its installation.
- Always place the appliance in a vertical position, in order to maintain the compressor in good working condition.
- Do not use the appliance near gas or other inflammable liquids.
- Do not block the air outlet and inlet ventilation.
- Do not use spray (insecticides, painting) or any other inflammable products near the appliance as the plastic case may be deformed. The unit may sustain electrical damage.
- **Power sources**
- The plug has to be well fixed and should not be damaged.
- Do not plug in the appliance with an adaptor.

- Plug into the wall socket before switching on the appliance then press on the ON/OFF button.

**THE MANUFACTURER WILL NOT ASSUME ANY RESPONSIBILITY IN CASE OF NON ADHERENCE TO THESE INSTRUCTIONS.
READ THIS USER MANUAL CAREFULLY.**

INSTALLATION

Selection of installation location

Keep the unit on a flat surface and dry place.
Leave at least 50cm space all around the unit.



Installation

Fix the exhaust pipe into the adapter, and then fix the other side of the exhaust pipe into the air outlet vent of the unit. (anti-clockwise)

Fix the adapter into the window slider kit, and then half open the window to meet the width of the window slider kit. The length of the window slider kit is adjustable.

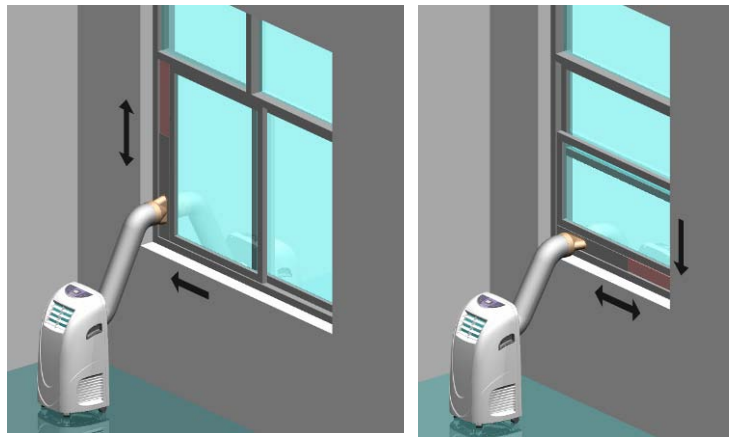
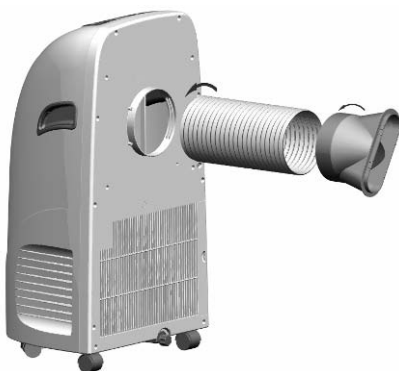

Incorrect mounting

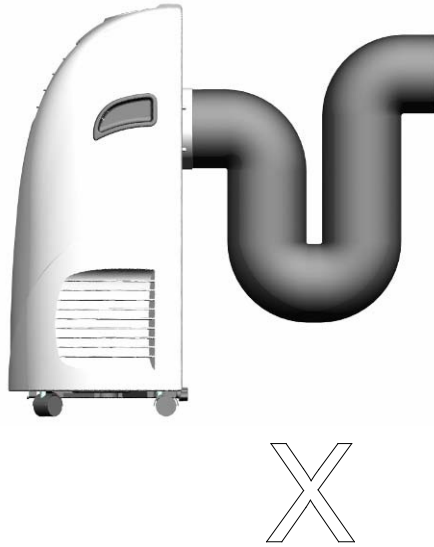

The bend of the exhaust pipe is very important. Incorrect mounting can prevent the machine from working correctly.

Take care to prevent any sharp bows or bends of the exhaust pipe.

The exhaust air must flow freely.

WARNING

The length of the exhaust pipe is specially designed according to the specification of this product. Do not replace or prolong it with your own private hose as this could cause mal-function.

BE CAREFUL: Maximum developed length of the exhaust pipe is 1500mm. Use the shortest possible length. When mounting, we advise to keep the exhaust pipe in a horizontal position.

PART NAME

Front

1. Control panel
2. Display
3. Button
4. Remote control receiver
5. Air outlet vent
6. Louver
7. Castor
8. Remote Control

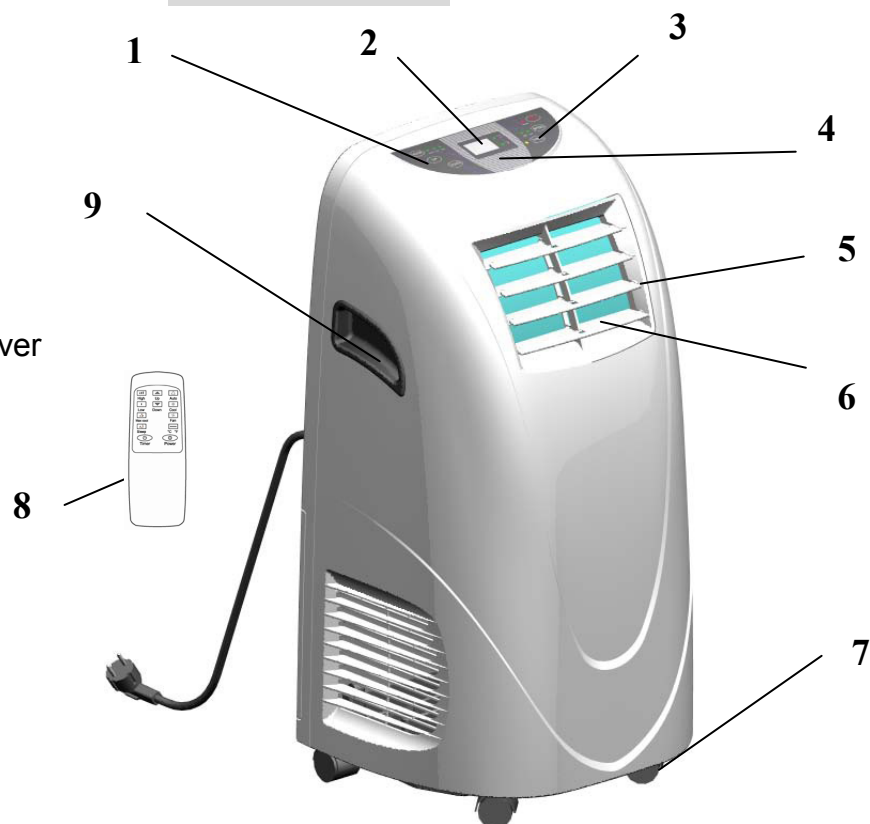

9. Handle

Back

10. Exhaust air outlet vent

11. Power cord

12. Big filter

13. Small filter

14. Draining hole

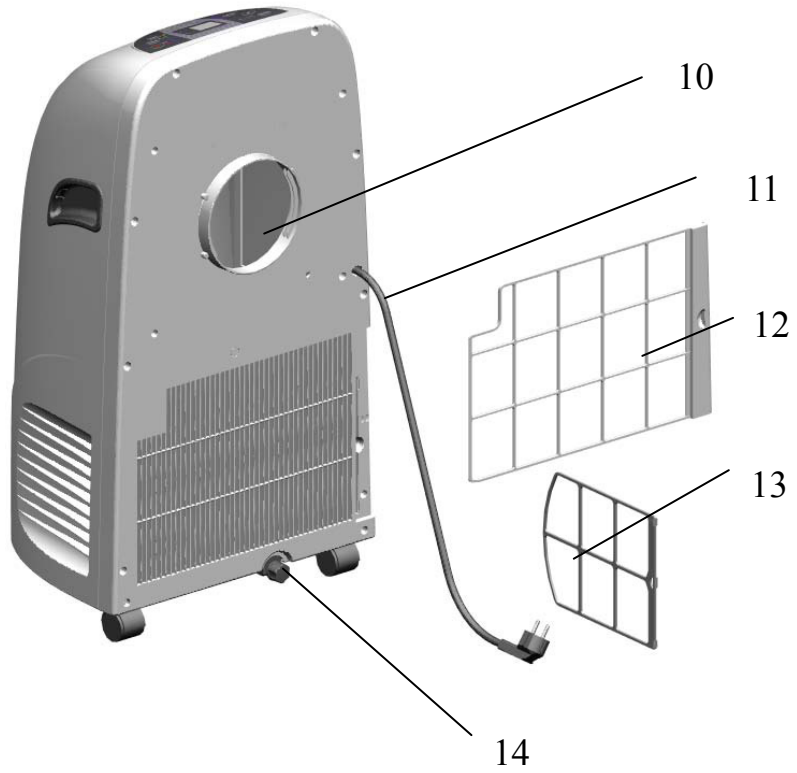

Check all the accessories included in the package and please refer to the installation instructions for their usage.

Accessories

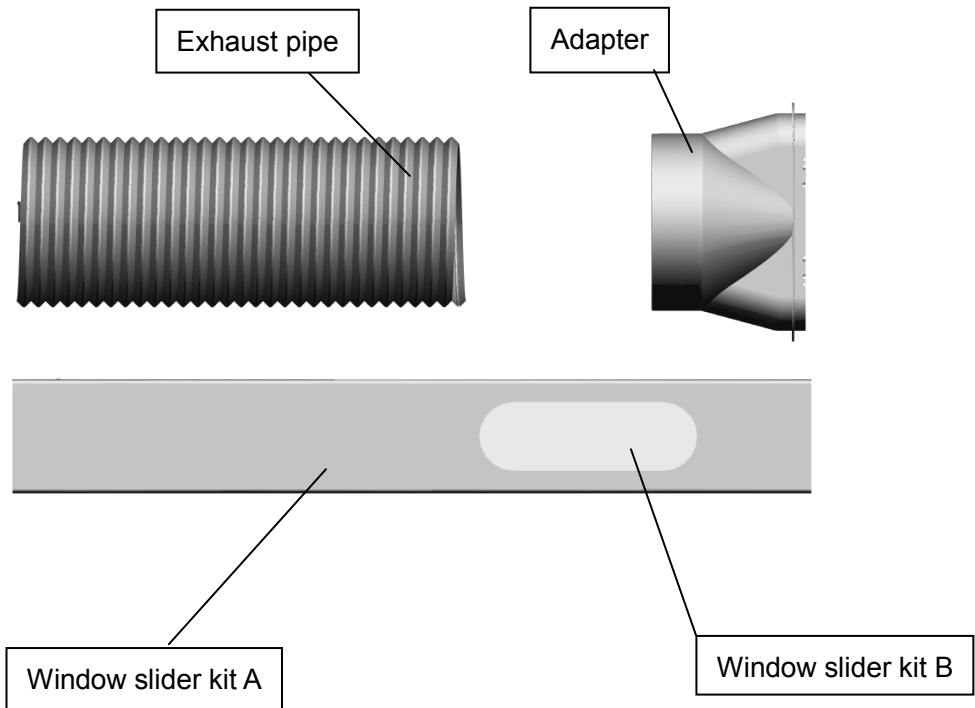

CONTROL PANEL



1. POWER button: press this button to turn on/off the unit.
2. MODE button: press this button to select Cooling, Automatic adjusting mode or Fan mode
3. SPEED button: press this button to select high, low fan speed
4. Timer: when stand-by time press this key to set automatic time on; when running time press this key to set automatic time off.
5. UP button: press this button to set the temperature higher when cooling; press this button to adjust time longer when timing; to exchange Fahrenheit and Celsius when press both UP and Down button
6. DOWN button: press this button to set the temperature lower or higher when cooling; press this button to adjust time shorter or longer when timing; to exchange Fahrenheit and Celsius when press both UP and Down button.

REMOTE CONTROL

1. Power
2. Celsius and Fahrenheit exchange button
3. Fan button
4. Cool Mode Button
5. Auto mode button
6. Down button
7. Up button
8. High fan speed button
9. Low fan speed button
10. Max cool button
11. Sleep Mode
12. Timer button

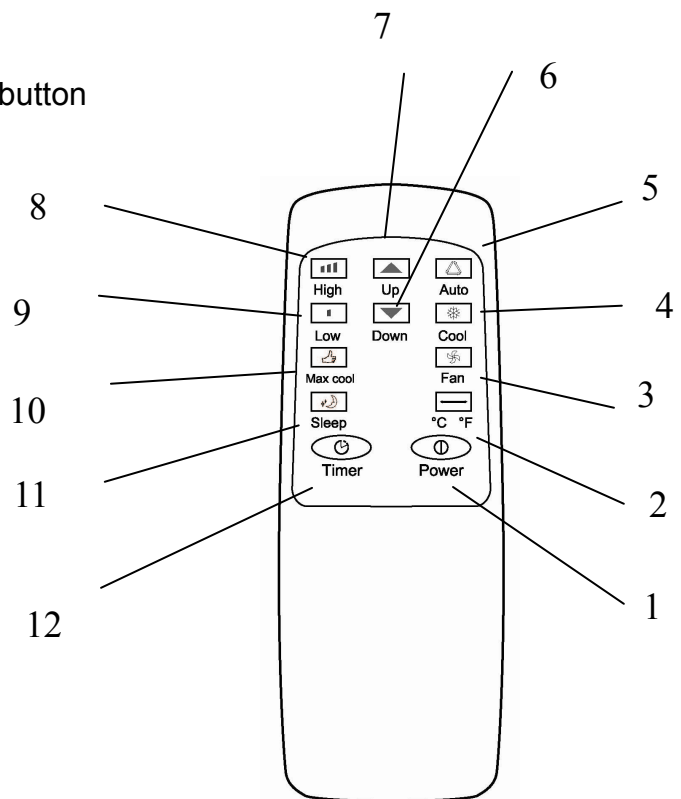

OPERATION METHODS

Cooling mode

Default Cool mode after operating the machine or press Mode button to choose Cool mode, the Cool mode indicator will flash.

- Press UP or DOWN button to set room temperature between 17°C to 30°C.
- Press FAN SPEED button (or High/Low button) to select high, low fan speed.

Fan mode

- Press Fan button to choose Fan mode, the Fan mode indicator will flash.
- Select the fan speed by press SPEED button or press High / Low button directly.
- The temperature can not be set.

Automatic adjusting mode

·Press Mode button to choose the automatic mode. Automatic mode indicator will flash. After choosing the automatic mode, the running state will depend on room temperature. When room temperature is higher than **25°C**, it will come into cool mode. On the contrary, it will be fan mode. You can select the fan speed mode and timer mode when it is under automatic adjusting mode.

Sleep Mode (Optional Function)

Press this button to activate or cancel sleep function in cooling mode

The unit will run at the low fan speed as default with lower noise. The setting temperature will increase 1 degree per 2 hours running time, and it will not change after increasing 2 degrees

Max cool Mode (Optional Function)

Press this button to activate the Max cool mode.

The unit runs cool but is not restricted by the temperature under the Max cool mode

The unit is forced to be in high fan speed under the Max cool mode and the fan speed cant be set.

Timer mode

·When the appliance is switch off, press Timer button to set timer-on.

·Press Up or Down button to adjust time from 0 to 24 hours. The Timer on indicator will flash.

When the appliance is running, press Timer button to set timer-off.

Press Up or Down button to adjust time from 0 to 24 hours. The Time off indicator will flash.

WATER DRAINAGE

This product has a self-evaporative system. The condensing water will be recycled to cool the condenser. This can not only improve cooling efficiency, but also save energy for you.

- If the inside water is full, the display panel will display “FL”, and the compressor will stop running.
- Please turn the machine off and move the machine to the place where can drain water, and then unplug the water-draining hole. After drainage, you can power it on and the machine will run again.

MAINTENANCE

Note: Turn off the unit and unplug it before any maintenance or repair begins to avoid electric shock.

Cleaning

- Unplug the unit before any cleaning.
- Clean the housing with a soft moisture cloth. Do not use chemical solvent (such as benzene, alcohol, gasoline). The surface may be damaged or even the whole case may be deformed.
- Do not sprinkle water on the unit.

Air filter



- Clean the air filter every 2 weeks. If the air filter is blocked with dust, the efficiency will reduce.
- Open the air filter cover upwards, and then take out the air filter.
- Wash the air filter by immersing it gently into warm (about 40°C) water with a neutral detergent, rinse it and dry it thoroughly in a shaded place.

End of season

- Please drain the water.
- Keep the unit running in Fan mode for two hours until the inside of the unit is dry.
- Turn off the unit and unplug it.
- Clean the air filter and after dry it thoroughly, reinstall it.
- Remove the exhaust pipes and keep them carefully.
- Wrap the unit with the plastic bag and keep it in a dry place.

TROUBLE SHOOTING

Before contacting professional service, check it first yourself referring to the followings:

Problem	Cause	Solution
The air conditioner does not function.	No power supply.	Connect to power supply outlet and switch on.
	“FL” flashes on the display screen	Drain water.
	Timer-off is running.	You can turn on the unit three minutes later.
The air conditioner restart frequently	In direct sunlight.	Close curtains.
	Windows or doors open, many people or a heat source in the room.	Close doors and windows, remove the heat source.
	Dirty filter.	Clean or replace the filter(s).
	Air inlet or air outlet blocked.	Remove the blockage.
The unit is too noisy	Unit stands uneven.	Place on an even, solid surface (less vibration).
No work of compressor	Self protect of compressor	Wait for 3 minute and restart again after the descend of temperature



Cautions: Switch off the unit and unplug it immediately if anything abnormal happens. Then contact a qualified electrician.

Above data without advance notice for product improvement.

Free Manuals Download Website

<http://myh66.com>

<http://usermanuals.us>

<http://www.somanuals.com>

<http://www.4manuals.cc>

<http://www.manual-lib.com>

<http://www.404manual.com>

<http://www.luxmanual.com>

<http://aubethermostatmanual.com>

Golf course search by state

<http://golfingnear.com>

Email search by domain

<http://emailbydomain.com>

Auto manuals search

<http://auto.somanuals.com>

TV manuals search

<http://tv.somanuals.com>