

Bushnell®



 **TROPHY[®]**
CAM HD

INSTRUCTION MANUAL

Model#: 119676C / 119677C / 119678C

05-14

IMPORTANT NOTE

Congratulations on your purchase of one of the best trail cameras on the market! Bushnell is very proud of this little unit and we are sure you will be pleased with it as well. We appreciate your business and want to earn your trust. Please refer to the notes below and the instructions in this manual to ensure that you are completely satisfied with this product.

If your Bushnell Trophy Cam HD does not seem to be functioning properly or if you are having photo/video quality issues, please check the Troubleshooting/FAQ section on pages 31-35.

Problems are often due to something simple that was overlooked, or require only changing one setting to solve.

If your problem continues after trying the solutions in the Troubleshooting/FAQ section, please call Bushnell Customer Service at (800) 423-3537. In Canada, call (800) 361-5702.

Bushnell recommends using a full set of Energizer® Lithium AA batteries (8 or 12, depending on the model) in these Trophy Cam HD models to obtain maximum battery life

**Do not mix old and new batteries
Do not mix battery types-use ALL lithium or ALL alkaline**

Bushnell recommends using SanDisk® SD and SDHC Cards (up to 32GB capacity, Ultra® or Extreme® series for HD video) in these Trophy Cam HD models

INTRODUCTION

About the Trophy Cam HD

The Bushnell **Trophy Cam HD** is a digital scouting camera. It can be triggered by any movement of game in a location, detected by a highly sensitive Passive Infra-Red (PIR) motion sensor, and then take high quality pictures (up to 8MP still photos), or video clips.

The **Trophy Cam HD** consumes very little power (less than 0.25 mA) in a stand-by (surveillance) state. This means it can deliver up to six months stand-by operation time when the device is powered by the full capacity of AA alkaline batteries, and up to twelve months utilizing lithium AA batteries. Once motion in the monitored area is detected, the digital camera unit will be triggered at once (typically within one second) and then automatically take photos or videos according to previously programmed settings. The **Trophy Cam HD** is equipped with built-in infrared LEDs that function as a flash, so that it delivers clear photos or videos (in black & white) even in the dark, and it can take color photos or videos under sufficient daylight. The **Trophy Cam HD HD** is designed for outdoor use and is resistant against water and snow.

Your trail camera is one of the latest generation of Bushnell **Trophy Cam HD HDs**, and includes many new or improved features, including:

- Auto PIR Sensitivity-the camera monitors ambient temperature conditions and automatically adjusts the sensor/trigger signal to be more sensitive to slight variations in temperature on hot days, less sensitive on cold days.
- Hyper NightVision-The IR LED Flash array now has increased range, brighter output and better coverage for improved nighttime images.
- Field Scan 2x with Live Trigger-This "time lapse" feature includes the option for a second block of recording with its own start/stop times. Trigger signals generated by nearby wildlife activity will still generate additional photos/videos as they normally would, independently of the Field Scan operation.
- GPS Geotag Capability-allows the user to input the longitude and latitude of the camera's position, which will be embedded in each photo file. This enables Google Earth, Picassa and other geotag enabled software to automatically show a map pinpointing each camera's location when a group of photos are reviewed on a computer.

Especially useful for those who setup multiple **Trophy Cam HDs** to monitor large or widely separated areas.

- Multi Flash Mode (LED Control)- prevents overexposed flash photos in close range applications
- Hybrid Capture Mode-allows both still photos and videos to be captured at each trigger, up to highest resolution settings for each.
- NV Shutter-user can select shutter speed for images captured at night allowing control over brightness vs. ability to stop motion
- Camera Operating Mode can be limited to Day only, Night only, or 24 HRs

And many more features such as HD Video with Audio, widescreen or fullscreen format still photos, imprintable camera name (user set) along with current data including temperature, moon phase and barometric pressure* (**imprinted barometer data only available on model 119678C*).

Applications

The **Trophy Cam HD** can be used as a trail camera for hunting or scouting game. It is also suitable for surveillance usage.

PARTS AND CONTROLS

The **Trophy Cam HD** provides the following connections for external devices: USB port, SD card slot and external DC power in (*pg 6, Fig. 1*).

A 3-way power switch is used to select the main operating modes: **OFF**, **SETUP**, and **ON** (*pg 6, Fig. 2*).

A control key interface with six keys is primarily used in **SETUP** mode to select operational functions and parameters. As shown on the next page, these keys are: **UP**, **DOWN**, **LEFT**, **RIGHT**, **OK** and **MENU**. Three of the keys can also perform a second function (shortcut operations in **SETUP** mode) in addition to their main function: The **DOWN** key can be used to set the camera to Photo mode (still camera icon), and the **UP** key can set the camera to Video mode (movie camera icon). The **RIGHT** key also serves as the manual shutter ("SHOT") button of the camera. These secondary functions are indicated by icons or text above the key as shown below.

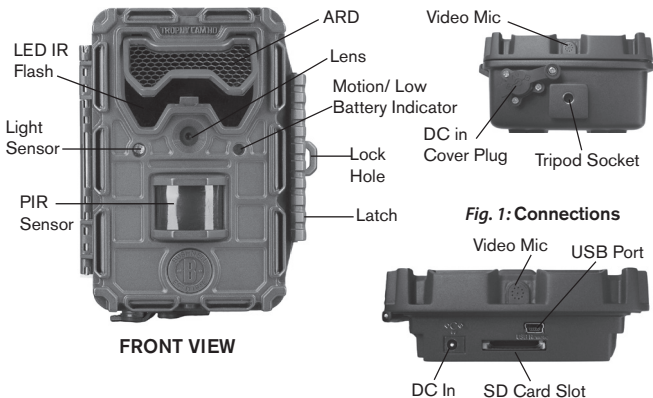

Fig. 1: Connections

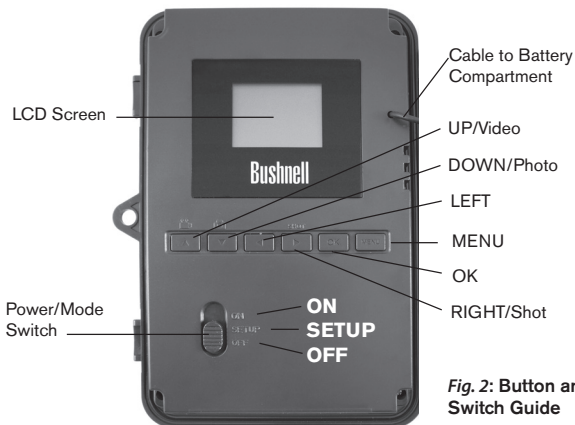

Fig. 2: Button and Switch Guide

INSTALLING THE BATTERIES AND SD CARD

Before you begin learning how to use your **Trophy Cam HD**, you will first need to install a set of batteries and insert an SD card. Although that may only take you a minute, there are some important notes about both batteries and SD cards you should be aware of, so please take the time to **read the following directions and cautions**:

Loading Batteries

After opening the two latches on the right side of the Trophy Cam HD, you will see that the **Trophy Cam HD** has eight or twelve battery slots, depending on your model. For maximum battery life, you should install a full set of batteries. The **Trophy Cam HD** may also be operated by just four batteries installed in the first slots only (*starting on the top or left-see photos*). Battery life will be shorter with 4 batteries, but the camera will operate normally. Whether you use 4 or a full set, be sure to insert each battery with correct polarity (negative or “flat” end against the long spring of each battery slot).

Bushnell recommends using a full set of new lithium AA (Energizer® brand) or alkaline AA batteries. NiMh Rechargeable batteries are not recommended, as the lower voltage they produce can cause operational issues.

Optionally, you can connect the #119656C Accessory Solar Panel (*please visit www.bushnell.com for more information*) to the “DC In” jack at the bottom of the **Trophy Cam HD** (*other external power supplies should not be used, as the camera and/or display may not function correctly*). If the solar panel is connected and AA batteries are installed, the **Trophy Cam HD** will be powered by the solar panel's rechargeable lith-ion battery, as long as it provides adequate voltage (if not, the camera will switch to battery power). The solar panel's battery will power the camera at night.

When the batteries become weak (*or a device with insufficient power is connected to DC In*), the low-battery indicator LED will glow blue, indicating the batteries should be changed (**pg 6, Front View**).



Inserting the SD Card

The **Trophy Cam HD** has 32MB of internal memory, which can hold only about 20 photos (@ 5MP resolution). This is handy for testing and getting familiar with the camera, but you will no doubt want to leave the camera unattended for longer than a day, so using an SD card is recommended for all models. Insert the SD card (with the camera's power switch in the **OFF** position) before beginning to operate the camera. Don't insert or remove the SD card when the power switch is in the **ON** position.

The **Trophy Cam HD** uses a standard SD (Secure Digital) memory card to save photos (in .jpg format) and/or videos (in .avi format). SD and SDHC (High Capacity) cards up to a maximum 32GB capacity are supported. Using high speed SD cards (SanDisk® Ultra® or Extreme® series or similar) is recommended if you will use the 1280x720 or 1920x1080 video settings. Before inserting the SD card into the card slot after opening the camera's front cover, please make sure that the write-protect switch on the side of the card is "off" (NOT in the "Lock" position). The following describes how to insert and remove the SD card:

- Insert the SD card into the card slot with its label side upwards (see *below*). A "click" sound indicates that the card is installed successfully. If the wrong side of the card is facing up, you will not be able to insert it without force—there is only one correct way to insert cards. If the SD card is not installed correctly, the device will not display an SD card icon on the LCD in SETUP mode (*the SD card icon displayed after switching to SETUP mode will have a "lock" symbol inside it in it if the card is locked*). Formatting the SD card by using the **Trophy Cam HD's** "Format" parameter before using it for the first time is recommended, especially when a card has been used in other devices (*see pg. 22, "Format" for details*).
- To take out the SD card, just gently push in the card (do not try to pull it out without pushing in first). The card is released from the slot and ready to be removed when you hear the click. **WARNING: Be sure the camera's power is switched OFF before inserting or removing SD cards or batteries.**



USING THE Trophy Cam HD

Once you've prepared your **Trophy Cam HD** by properly installing batteries and an SD card, you could simply take it outside, strap it to a tree, switch it on and leave-and you might get some great photos that are exactly what you wanted. However, we highly recommend that you first spend some additional time indoors with this manual and your camera until you know a bit more about what the 3-way switch and those control keys do. If nothing else, you'll probably want to at least set the date and time so the camera will imprint them (or not-it's your option) on your photos as they are taken, learn how to set the camera to shoot video clips instead of still photos if you like, and read some tips about mounting it on a tree.

THE OFF, ON, AND SETUP MODES

The **Trophy Cam HD** has three basic operational modes:

- **OFF** mode: Power switch in the **OFF** position.
- **ON** mode: Power switch in the **ON** position (LCD screen is off.)
- **SETUP** mode: Power switch at **SETUP** position (LCD screen is on).

OFF MODE

The **OFF** mode is the "safe" mode when any actions must be taken, e.g., replacing the SD card or batteries, or transporting the device. You will also use **OFF** mode if you connect the camera to a computer's USB port later to download your photos/videos. And of course, when you are storing or not using the camera, you will switch it to **OFF**. Please note that even in the **OFF** mode the **Trophy Cam HD** still consumes power at a very low level. Therefore, it's a good idea to take the batteries out of the battery compartment if the camera will not be used for a long time.

ON MODE

Anytime after the batteries and SD card have been inserted, you can switch on the camera. When the power switch is moved to the top position, the camera will enter into the **ON** (Live) mode. The motion indicator LED (pg. 7, "Front View") will blink red for about 10 seconds. This interval allows time for you to close the **Trophy Cam HD's** front cover, lock it, and leave the monitored area. Once in the **ON** mode, no manual controls are needed or possible (the control keys have no effect). The **Trophy Cam HD** will take photos or videos automatically (according to its current parameter settings)

when it is triggered by the PIR sensor's detection of activity in the area it covers.

You can either move the power switch directly from OFF to ON mode, or stop at the SETUP position first to change one or more settings, then move the switch to ON after you have finished doing so.

SETUP MODE

In the **SETUP** mode you can check and change the settings of the **Trophy Cam HD** with the help of its built-in LCD. These settings, found in the SETUP Menu, let you change the photo or video resolution, interval between photos, switch the time imprint on, etc. Moving the power switch to the **SETUP** position will turn on the LCD display, and you will see an information screen that shows how many images have been taken, the battery level, camera or video mode, etc (*Fig. 3, next page*).

NOTE: Always move the power switch from **OFF** to **SETUP** mode. It is possible that the camera could lockup if it is switched from **ON** to **SETUP** mode. If this occurs, simply move the switch to **OFF** and then push it up to **SETUP** again.

SETUP Mode Shortcut Keys/Functions

As mentioned earlier in "Parts & Controls", four of the keys below the LCD have secondary, "shortcut" functions when the camera is switched to **SETUP** mode (but the **MENU** key has not been pressed):

- Press the **UP** key to quickly set the camera to shoot video clips.
- Press the **DOWN** key to quickly set the camera to take still photos.
- Press the **RIGHT** key to manually trigger the shutter. This is useful for testing the camera-make sure you are in **SETUP** mode, press the **RIGHT** key, and a few seconds later a photo or video (depending on how the camera was set) will be saved to the SD card (or internal memory if no card is inserted). The "number of images taken" counter on the bottom left of the LCD will increase by one. If the display indicates "SD PROTECTED" when you press the SHOT key, switch the camera OFF, remove the SD card and slide its protect switch off.

Fig. 3: SETUP Information Screen

Camera (Still Photo) Mode

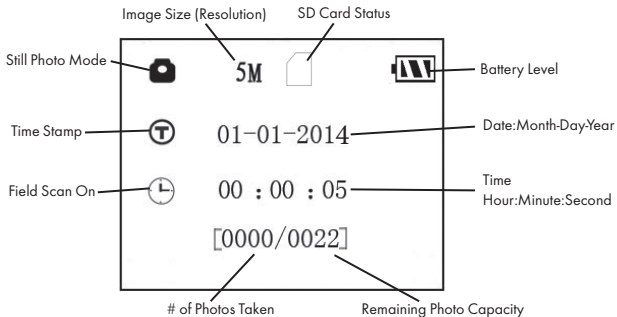

Video Mode

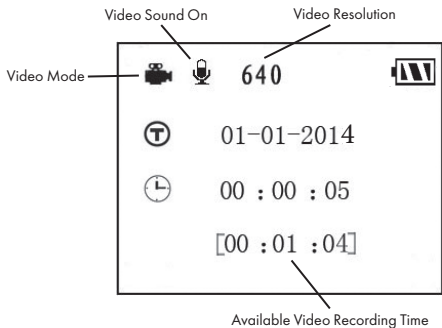

USING THE SETUP MENU TO CHANGE SETTINGS

The main purpose of the **SETUP** mode is to allow you to change the settings of the camera's parameters (19 different ones are available!) so your **Trophy Cam HD** operates exactly the way you want it to. You will do this by entering the **SETUP** Menu and pressing the keys below the LCD display, which will show you each parameter and its setting.

Changing Parameter Settings in SETUP Mode

A wide range of options or "parameters" are provided to allow you to set the **Trophy Cam HD** to your operational preferences. To change the setting of any parameter you must first switch to the **SETUP** mode. Once in **SETUP** mode, pressing the **MENU** button will allow you to select any parameter and change its setting. The name of the parameter and its current setting will be shown on the LCD. Pressing the **RIGHT** or **LEFT** key scrolls to the next or previous parameter (**RIGHT** key to move on to the next parameter and **LEFT** key to go back to the previous parameter), and pressing the **UP** or **DOWN** key lets you select a different setting for the currently displayed parameter. Once you have selected your preferred new setting for a parameter, press the **OK** button to save the new setting (actually change it). When you are finished changing the settings of one or more parameters, press **MENU** again to exit the **SETUP** menu. **MENU** can also be pressed anytime you want to cancel changing a parameter's setting after a new setting has been selected (but **OK** has not been pressed yet). After setting the parameters to your preferences, be sure to move the switch to **ON** to begin actually taking photos or videos. No images will be captured if the switch is left in the **SETUP** position (*unless you press the **RIGHT/Shot** key after exiting the menu*)- in fact, the camera will power off automatically after a few minutes with no key pressed.

Parameter Settings Display

The settings for each parameter are shown on the display screen of your **Trophy Cam HD**. Only one setting is displayed at a time, starting with the current setting for the parameter when it is first selected (*pg. 13, Fig. 4a*). To change the setting, use the **UP/DOWN** keys to display the new setting you want (*Fig. 4b*), then press **OK** to "Execute" (make the actual change to this setting). If you want to confirm this setting is now the current one, just press the **RIGHT** key to scroll to the next parameter, then press **LEFT** to go back again to the previous one. You should see the parameter setting you just made.

Fig. 4: Selecting Parameter Settings

Press MENU

(4a)



Press DOWN

(4b)



Press OK

EXAMPLES-Changing the Settings of Some Common Parameters

Following this page, you will find tables listing all of the parameters found in the **SETUP** Menu, along with their possible settings (or range of settings), and a detailed description of what the parameter controls and what the settings do. If you read the previous section detailing how to select parameters and change their settings, you should be able to dive right in, find the parameter(s) you want, and setup the camera to suit your preferences. But maybe you'd rather walk through an example or two first:

To change any parameter's setting, always start with the power switch in the **SETUP** position. After the LCD comes on, press the **MENU** key.

The first parameter you will see when you first enter the **SETUP** Menu is "Mode". To change it from its default setting of "Camera" (still photos) to "Video" (shoot video clips), press the **DOWN** key to select the "Video" setting. Press the **OK** key to "Execute" (Set) the new setting you've selected for this parameter.

Now press the **RIGHT** key to move to another parameter in the Menu. Pressing it three times will take you to "Capture Number". Try using the **UP** and **DOWN** keys to scroll through the range of settings, then press **OK** to lock in your setting for the number of photos the camera takes each time it's triggered.

Pressing the **RIGHT** key until you reach the last menu item, you'll see the "Default Set" parameter. Highlight or select "Execute" (using **UP** or **DOWN**) and press **OK** to restore all parameters (including the Mode and Video Length parameters you changed a minute ago) back to their original factory default settings. The default settings for each parameter are indicated in bold type in the **SETUP** Menu tables on the next several pages.

Be sure to set the current date and time, using the "Set Clock" parameter, if you choose to change the "Time Stamp" parameter setting to "On" since that will tell the camera to imprint the date and time on each of the images it captures.

Field Scan 2x with Live Trigger Feature

Field Scan is a revolutionary new feature for the Bushnell **Trophy Cam HD**, which allows you to monitor your food plots or field edges with time lapse images or video. When set to "On", the **Trophy Cam HD** will take a photo (or record a video clip) automatically at your choice of intervals (for example, once every five minutes) during one or two blocks of time you set up for each day, **without requiring a trigger from an active animal**. This has the advantage of giving you the ability to monitor the edge of a field that might be 50 or 150 yards away from the camera out of the PIR sensor's range. The result is an effective range much greater than it would normally be, with the camera dependant on triggers generated by nearby animals. This is a great tool for hunters to scout an entire field with only one camera.

If an animal does enter the area covered by the PIR sensor and generate a trigger event during a time in between the Field Scan intervals you set, the camera will capture an image or video just as it normally would, based on your other menu settings. Here's how to setup and use Field Scan (be sure you've set the current time in "Set Clock" first, so your Field Scan recording will stop and start at the correct times of day):

1. Move the main switch to **SETUP**, then press **MENU**.
2. Keep pressing the **RIGHT** key, stepping through the Setup Menu until you reach Field Scan.
3. Press the **UP** key to select On, and press **OK [Step 1, pg.17]**. You will see "A", representing the first block of time you can define (a second block of time later in the day, "B" can also be setup if you wish). Press **OK [Step 2]**. This takes you to the screen to set Start and Stop times, which determines the clock times when the first block of Field Scan recording will begin and end for each day. You can set these times to the exact hour and minute you want, for a recording "window" that lasts anywhere from just a minute to a full 24 hours.
4. Set the [Start] and [Stop] times, beginning with the Start hour, using the **UP/DOWN** keys to change the setting **[Step 3]**. The hour setting is based on a 24-hour clock, with "00" hours = midnight, "12" hours = noon, "23" hrs = 11PM, etc. To move to the next setting, press the **RIGHT** key, change the minute for the Start time with **UP/DOWN**, then on to the hour and minute settings for the Stop time.

- After you finish setting the Stop minutes, press **OK** to confirm your settings for the first block of Field Scan recording. If desired, you can create a second block of time by pressing the **DOWN** key to select "B" **[Step 4]**, then press **OK** and follow the same process to set Start and Stop times for Field Scan block "B" **[Step 5]**. As an example of how you might use these two available time blocks, you could setup Field Scan time block "A" for the dawn hours from 6 AM to 8 AM, and block "B" to capture images between 5:30 and 7 PM. No Field Scan recording would occur from 8AM to 5:30PM, or from 7PM to 6AM.
- After setting Start/Stop times to define Field Scan block "A" and/or "B", press **OK**, then press the **UP** or **DOWN** key to select "Interval" and press **OK** **[Step 6]**. The Field Scan "Interval" setting lets you control how often a photo or video clip is recorded during the block(s) of time you defined with the Start and Stop settings. Your options are 60 minutes, 30 minutes, 15 minutes, 5 minutes (this is the default), or 1 minute (still photo mode only). Use the **UP/DOWN** keys to select your preference, then press OK to save it **[Step 7]**. Note that for videos, "Interval" is independent of the Length of each video recording-it's **how often** videos are recorded, not how long each one lasts.
- Here's an example of how the camera would operate, based on the following Field Scan settings:

Field Scan: On

Field Scan A:

[Start]: 6:00

[Stop]: 8:00

Field Scan B:

[Start]: 17:30

[Stop]: 19:00

Interval: 15M

Note: avoid any "overlap" of Field Scan A & B recording blocks when setting their start and stop times, to assure correct operation. Also-if the "Camera Mode" menu parameter is set to "Day" or "Night" operation only, that will take priority over your Field Scan settings. Set the Camera Model to "24 HR" if you are setting both day and night start and/or stop times in Field Scan.

These settings would cause the camera to capture a photo (or video, if the camera is set to that mode) once every 15 minutes, beginning at 6 AM, until the Field Scan "A" recording block stops at 8:00 AM. Later that day, the camera would again take a photo or video every 15 minutes between 5:30 PM and 7:00 PM (during Field Scan time block "B"). The next day, the camera would again record an image or video once every 15 minutes between 6:00 and 8:00 AM, and between 5:30 and

7:00 PM. No Field Scan recording would occur from 8AM to 5:30PM, or from 7PM to 6AM. Remember, Field Scan recording is independent of normal triggers due to animal activity—even if no animals enter the IR sensor coverage zone, an image or video will still be captured every 15 minutes during the block(s) of time. If an animal triggers the camera “in between” the 15 minute intervals, it will be recorded.

Note: Field Scan settings of frequent intervals and/or long periods between start and stop time can reduce battery life.



[Step 1]-set Field Scan Mode to “On”

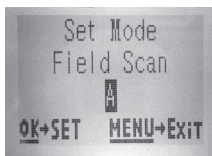

[Step 2]-select Field Scan “A” (press OK)

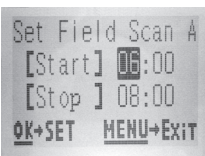

[Step 3]-set Field Scan “A” Stop & Start

Steps 4 & 5 are optional (only required if you want to set up a second block of Field Scan recording with different stop and start times)

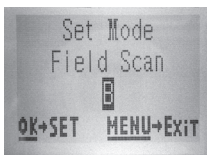

[Step 4] (opt)-select Field Scan “B” (press OK)



[Step 5] (opt)-set Field Scan “B” Stop & Start

Note: the Interval Setting sets the timing between each image for both Field Scan “A” and “B” recording blocks.



[Step 6]-select Field Scan “Interval”

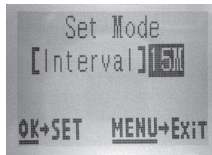

[Step 7]-set Field Scan Interval

The SETUP Menu – Parameters and Settings List w/Descriptions

Parameter	Settings (Bold =default)	Description
Mode	Camera , Video, Hybrid	Selects whether still photos or video clips are captured when the camera is triggered. Hybrid mode combines both Camera and Video, so a still photo and a video clip are both captured for each trigger.
Image Size <i>(only affects still photos in Camera or Hybrid modes)</i>	3M Pixel, 5M Pixel , 8M Pixel,	Selects resolution for still photos from 3 to 8 megapixels. Higher resolution produces better quality photos, but creates larger files that take up more of the SD card capacity (fills up faster). 5M is a good compromise between quality and file size.
Image Format <i>(only affects still photos- format for video is tied to Video Size)</i>	Full Screen , Wide Screen	Selects 4:3 (Fullscreen, like old TV sets) or 16:9 (Widescreen, like new flat TVs) “aspect ratio” for still photos. If you like to view your photos on a TV set or computer monitor, you can set the format to match it.
Capture Number <i>(only affects still photos in Camera or Hybrid modes)</i>	1 Photo , 2 Photo, 3 Photo	Selects how many photos are taken in sequence per trigger in Camera mode. This setting affects photos taken in Field Scan mode as well (to snap two photos every 10 minutes, for example). <i>Please also refer to the Interval parameter.</i>

Parameter	Settings (Bold =default)	Description
LED Control (Multi-Flash feature)	Low, Medium, High	Controls how many LED lamps fire when images are taken in low light. "High"=all 33 LEDs fire, which is the default setting. Set to Medium or Low if you are getting overexposed flash photos or will place the camera at very close range to the subject you want to photograph. In general, select High if most of your intended subjects will be over 30 ft. from the camera, Medium for the 15 to 30 ft. range, and Low for subjects under 15 ft. away. <i>Note: in video mode, 21 LEDs fire in both High & Medium (default) settings. Set to Low if videos are overexposed.</i>
Camera Name	(Input) <i>See "Using the Setup Menu Input Screens"</i>	Allows the user to set a custom name for the camera. Useful for ID purposes when multiple cameras are setup, since each camera will imprint its name on all photos (but not videos) it captures.
Video Size <i>(only affects video clips in Video or Hybrid modes)</i>	<i>(Model 119676/119677):</i> 1280x720, 640x360 , 320x180 <i>(Model 119678):</i> 1920x1080, 1280x720 , 640x360	Selects video resolution (in pixels per frame). Higher resolution produces better quality videos, but creates larger files that take up more of the SD card capacity (fills up faster). 640x360 is VGA video in "widescreen" 16:9 format. The highest setting provides HD video. Using high speed SD cards (SanDisk® Ultra® or Extreme® series or similar) is recommended if you will use the 1280x720 or 1920x1080 video settings.

Parameter	Settings (Bold=default)	Description
Video Length <i>(only affects video clips in Video or Hybrid modes)</i>	10S (second) default, with 60S to 5S possible range	Sets length per captured video clip. Settings begin with 10 second default when parameter is first selected. After stepping down to 5S, video length settings start over at 60S.
Interval	10S (second) default, with a 60M (minute) to 1S (second) range of settings available. <i>(60M-1M are set in one minute increments, 59S-1S are set in one second increments)</i>	Selects the length of time that the camera will "wait" until it responds to any additional triggers from the PIR after an animal is first detected and remains within the sensor's range. During this user set "ignore triggers" interval, the camera will not capture photos/videos. This prevents the card from filling up with too many redundant images. Settings begin with 10 second default when parameter is first selected. <i>Note: after setting down past "1S", settings start over at "60M".</i>

Parameter	Settings (Bold =default)	Description
Sensor Level	Low, Normal, High, Auto	Selects the sensitivity of the PIR sensor. The "High" setting will make the camera more sensitive to infrared (heat) and more easily triggered by motion, and the "Low" setting makes it less sensitive to heat and motion. The High setting can be useful when the ambient temperature is warm (making it more difficult for the sensor to detect animals), and the Low setting may help in cold weather if the camera is being triggered too often by anything warmer than the surroundings. "Normal" is for average or moderate conditions. The default "Auto" setting will allow the camera to determine the best setting based on its current operating temperature. This is an ideal setting if the weather is expected to change significantly during the period the camera will be used.
NV (Night Vision) Shutter	High, Medium, Low	Affects the shutter speed during Night Vision operation. High will freeze motion better, but photos may be darker. A Low shutter speed setting will produce brighter photos, but rapid motion may be blurred. Medium is a good compromise.
Camera Mode	24 Hrs , Day, Night	Allows user to limit operation to only day or night period if desired. An ambient light level sensor determines "Day" vs "Night" automatically. This setting takes priority over any Field Scan settings.

Parameter	Settings (Bold =default)	Description
Format	Execute <i>(followed by an additional No/Yes step)</i>	Deletes (erases) all files stored on a card to prepare it for reuse. Always format a card that has been previously used in other devices. Caution! Make sure you have downloaded and backed up any files you want to preserve first! Press OK to execute, press MENU (or select NO then press OK) to exit without formatting.
Time Stamp	Off, On	Select "On" if you want the date & time (that the image was captured) imprinted on every photo/video, select "Off" for no imprint. Note: the current temperature, moon phase, and (user set) camera name will also be imprinted on your still photos. Model 119678C imprints the barometric pressure as well (<i>on still photos only</i>).
Set Clock	(Set)	Press OK and use the UP/DOWN keys (to change the setting) and LEFT/RIGHT keys (to move to the next field) to set the hour (<i>24-hr format only</i> , "00"=midnight, "12"=noon) and minute, and then (on the lower row), the year, month and date.

Parameter	Settings (Bold =default)	Description
Field Scan	On, Off <i>(After On is selected):</i> "A" Start/Stop, "B" Start/Stop, Interval	Turns Field Scan (Time Lapse) recording mode on/off. When activated, Field Scan forces the camera to take photos or videos even when it is not triggered by a nearby live animal, useful for constant monitoring of an area that might be far away from the camera. The user can set the start and stop times for up to two independent "blocks" of Field Scan recording, as well as the interval time between each photo/video. To ensure correct operation, avoid setting overlapping start/stop times for Field Scan A and B. Please read the "Field Scan 2x..." section of this manual for details on using this feature. NOTE: If the "Camera Mode" parameter is set to "Day" or "Night" operation only, that will take priority over your Field Scan settings. Set Camera Mode to "24HR" if you are setting day and night Field Scan start and/or stop times.
Coordinate Input	Off , On <i>See "Using the Setup Menu Input Screens"</i>	Allows the user to input latitude and longitude coordinates for the camera's location. This data will be embedded in the files saved on the camera's SD card (if "On" is selected). This makes it possible to see each camera's location as a "pushpin" on Google Earth maps when reviewing a folder full of photos from multiple cameras, or use other "geotag" capable software (Picassa, etc).

Parameter	Settings (Bold=default)	Description
Video Sound <i>(only affects video clips in Video or Hybrid modes)</i>	On , Off	Select "On" to record audio along with the video when the camera is set to video mode (saved file sizes will be slightly larger).
Default Set	Cancel, Execute	Select "Execute" and press OK to restore all parameters to the original factory default settings. If the camera is behaving oddly and you think you may have changed the setting for something accidentally (but aren't sure which one), this will reset all parameters to their most commonly used or "generic" settings.

USING THE SETUP MENU INPUT SCREENS

Camera Name Input

After selecting the Camera Name parameter (the only setting is "Input"), press **OK**. If necessary, delete the previous or default name by pressing the **RIGHT** key until the backspace symbol (←) (located between letters "A" & "B", also between "j" & "k") is highlighted, then keep pressing **OK**. Select (highlight) each alphanumeric character you want, using the **LEFT/RIGHT** keys, and pressing **OK** after each one to set it. When finished naming the camera, press **MENU** to save the name to memory.

Coordinate Input

After selecting the Coordinate Input parameter, press **UP** or **DOWN** to select the On setting and press **OK**. The latitude and longitude for any location where you plan to place the camera can be obtained at many websites, for example: <http://itouchmap.com/latlong.html>. You can enter a nearby street address, just zip code, or use the various types of maps to locate the approximate position. The format you will need to use to enter the coordinates in the Trophy Cam HD menu screen is shown below:

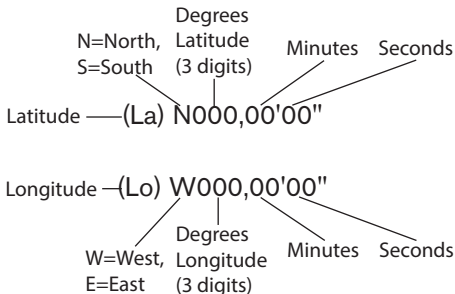

Note: You may see "negative" latitude or longitude coordinates online. These designate South latitudes and West longitudes. US/Canada locations will have North (+) latitude coordinates and West (-) longitude coordinates.

MOUNTING and POSITIONING the TROPHY CAM HD

Mounting

After you've set up the camera's parameters to your personal preferences at home or in your truck, you're ready to take it outside and slide the power switch to "ON". When setting up the **Trophy Cam HD** for scouting game or other outdoor applications, you must be sure to mount it in place correctly and securely. We recommend mounting the **Trophy Cam HD** on a sturdy tree with a diameter of about 6 in. (15cm). To get the optimal picture quality, the tree should be about 16-17 ft. (5 meters) away from the place to be monitored, with the camera placed at a height of 5-6.5 ft. (1.5~2 m). Also, keep in mind that you will get the best results at night when the subject is within the ideal flash range, no farther than 60' (19m) and no closer than 10' (3m) from the camera.

There are two ways to mount the **Trophy Cam HD**: using the provided adjustable web belt, or the tripod socket.

Using the adjustable web belt: *Fig. 5* illustrates using the web belt on the **Trophy Cam HD**. Push one end of the belt through the two brackets on the back of the **Trophy Cam HD**. Thread one plastic buckle part onto each end of the belt. Fasten the belt securely around the tree trunk by clicking the buckle ends together after tightening the belt so there is no slack left.

Using the tripod socket: The camera is equipped with a socket at the bottom end to enable mounting on a tripod or other mounting accessories with a standard 1/4-20 thread.

Fig. 5: Attaching the Belt



Another socket, on the back of the camera, is also provided for accessory mounting devices. Two optional mounting accessories, a “Bear Safe” metal camera box (#119657C for 119676C/119677C, #119658C for 119678C) and Deluxe Tree Bracket (# 119652C fits all 3 camera models) are also available-please see your Bushnell dealer or website for more details.

Note: an accessory solar panel (#119656C) supplemental power source is also available - please visit www.bushnell.com for more information.

Sensing Angle and Distance Test

To test whether the **Trophy Cam HD** can effectively monitor the area you choose, this test is recommended to check the sensing angle and monitoring distance of the **Trophy Cam HD**. To perform the test:

- Switch the **Trophy Cam HD** to the **SETUP** mode.
- Make movements in front of the camera at several positions within the area where you expect the game or subjects to be. Try different distances and angles from the camera.
- If the motion indicator LED light blinks, it indicates that position can be sensed. If it does not blink, that position is outside of the sensing area.

The results of your testing will help you find the best placement when mounting and aiming the **Trophy Cam HD**. The height away from the ground for placing the device should vary with the animal size appropriately. In general, 3 to 6 feet is preferred.

You can avoid potential false triggers due to temperature and motion disturbances in front of the camera by not aiming it at a heat source or nearby tree branches or brush (especially on windy days).

Switching ON the Camera

Once you switch to the **ON** mode, the motion indicator LED (red) will blink for about 10 seconds. This gives you time to close and lock the front cover of the **Trophy Cam HD** and then walk away. During this time, the motion indicator LED will blink red continuously. After it stops blinking, the PIR is active, and any motion that is detected by it will trigger the capture of photos or videos as programmed in the **SETUP** Menu. Be sure you have read the descriptions of the Capture Number, Video Length, Interval and Sensor Level parameters. Please note, the PIR is strongly sensitive to ambient temperature. The greater the temperature difference between the environment and your subject, the

farther the possible sensing distance. The average sensing distance is about 45 ft.

Before leaving the camera unattended, please check for the following:

- Are the batteries or DC power supply inserted/connected with correct polarity and is the power level is sufficient?
- Does the SD card have sufficient available space and is its write-protection (lock) switch off?
- Is the Power switch in the **ON** position? (do not leave it in **SETUP**).

About the ARD (Anti Reflective Device)

A removable filter grid (ARD) covers the LED flash, so that light reflections from the protective black glass panel over the LED array are greatly reduced. This helps to prevent detection of the camera by animals (and potential thieves). If getting maximum light output from the LED flash is a higher priority than concealment, the ARD grid may be easily removed by inserting a small screwdriver, key, etc. in the slot at the lower center of the ARD (above the camera lens), and gently pulling it up away from the camera (*see pg. 6*).

REVIEWING/DELETING THE PHOTOS/VIDEOS

After you have setup, mounted and activated your **Trophy Cam HD**, you will of course be eager to return later and review the images it has captured for you. There are several different ways this can be done.

Reviewing Images Directly From the SD Card

This is the most popular method of viewing images. Since unmounting the camera and taking it to your computer isn't very convenient, you may find it easier to just take the card out. By removing the SD card (swapping it for a new empty card if you like) and taking it to your home or campsite to view the images by using an SD card "reader" (*user supplied*) connected to your computer (some computers and TVs have a built in SD card slot), you can leave the camera in place ready to capture more images. Once connected, the card reader works the same way as described below-please read that section if you have any problem finding your files.

Reviewing Images by Connecting the Camera to a Computer

You can always unmount the entire camera from the tree and connect its USB port to a computer—it will be recognized as a “removable disk”, without the need to install any drivers or software. When using a PC (or Mac*) to view photos (or video clips*), first connect the device to the computer with the supplied USB cable. Then use commercial software with an image browser feature, or an image browser included with the PC’s operating system to view images saved on the SD card in the folder \DCIM\100EK113 (*a new folder will be created every 1000 images*). Each new image or video will be numbered incrementally in order of the time it was captured. For example, you will see file names such as “EK0001.JPG” or “EK0001.AVI”, etc. Through the file format suffix you can distinguish whether the file is a still photo (with suffix .JPG) or a video (with suffix .AVI).

**video files may require additional software for viewing on a Mac.*

The **Trophy Cam HD** supports 3 kinds of file system formats, FAT12, FAT16, and FAT32. The default value is FAT16 to save photos and videos. Here are some related notes:

- You don’t need to be concerned about the file system format of the **Trophy Cam HD** unless your equipment has problems reading the SD card. If this happens, please format the SD card with the **Trophy Cam HD** or in your computer first and then insert the card into your **Trophy Cam HD** and try again.
- The default file system format of the **Trophy Cam HD** is FAT16, which most computers can read. If you format an SD card for the **Trophy Cam HD** in your computer, you should choose the file system format FAT16. Normally FAT16 is recommended unless you have another image viewer that uses FAT12 or FAT32 format.

Deleting Photos or Videos

To delete all photos from the installed SD card, use the **Format** parameter (*see pg. 22 for details*).

DOWNLOADING THE PHOTOS/VIDEOS

To download your photos/videos to a PC or Mac*, first make sure the **Trophy Cam HD** power switch is in the **OFF** position. Connect the supplied cable to the camera's USB port, then directly to a main USB port on your computer—do not use front panel/keyboard USB ports or unpowered “hubs”.

The **Trophy Cam HD** will be recognized as a standard “USB Mass Storage” device (this may take several seconds the first time you connect it). If you would rather leave your camera in the woods and just pull its SD card out, an SD card reader works the same way as described in this section once the card is inserted and the reader is connected to your computer.

With Windows XP or later*, you can then simply use the options in the pop-up window to copy, view, or print your photos (*right*).

On all Windows OS, the **Trophy Cam HD** will also be listed as a “Removable Disk” if you open the “My Computer” window (on Macs, an icon will appear on your desktop). The **Trophy Cam HD**'s photo files are named “EK0001.JPG” etc, and are located in the “DCIM\100EK113” folder on this “Removable Disk”. Video file names will end with “.AVI”. You may copy the photos/videos to your hard drive as you would any file—just copy/paste or drag the file names or icons to your drive or desktop.

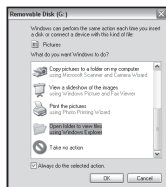

After the photos are copied to your hard drive, you can disconnect the **Trophy Cam HD**. (On Mac computers, drag the “disk” that appeared on your desktop when the camera was connected into your Trash to “eject” it before disconnecting.) The .JPG format photo files from the **Trophy Cam HD** may be viewed and edited with any photo software you choose to use. The .AVI video files may be viewed with the Windows Media Player on PCs with Windows 7.

*If your computer is running an older version of Windows, or you are on a Mac, and you don't already have a compatible video player, you can download a free version of the DivX player from <http://www.divx.com/>.

TROUBLESHOOTING / FAQ

Camera takes continuous images of no subject

A camera has what is known as a “false trigger” if the PIR sensor thinks that there is motion and heat in front of the camera lens when there is no subject in the image. These “False Triggers” are the result of placing the camera in an environment where there is motion associated with tree branches creating motion in front of the camera or an area where there is high heat in the foreground and any motion from wind could set off the camera. Setting a camera up over water is also a potential cause for this issue. To remedy this situation:

1. Try moving the camera to an area that does not have any of these issues or try changing the sensor level on the menu settings.
2. If the camera continues to take images when there is no subject in them, try placing the camera in an inside environment and aiming at a location where there is no motion.
3. If the camera continues to show issues, then there is probably an electronic component issue. If this is the case, please contact our customer service to send the camera back for repair.

Battery life is shorter than expected

1. Battery life will vary with operating temperature and the number of images taken over time. Typically, the **Trophy Cam HD** will be able to capture several thousand images before the batteries die.
2. Check to make sure you have used new alkaline or lithium batteries. **Bushnell recommends using a full set of Energizer® Lithium AA batteries in your Trophy Cam HD model to obtain maximum battery life.**
3. Make sure that the power switch was turned to the “On” position and that the camera was not left in “Setup” mode while in the field.
4. Make sure that you are using a good quality name brand SD card in your camera. **Bushnell recommends SanDisk® brand SD Cards up to 32GB (Ultra® or Extreme® series for HD video).** Our experience indicates that poor quality SD cards can sometimes reduce your **Trophy Cam HD** battery life.

Camera stops taking images or won't take images

1. Please make sure that the SD card is not full. If the card is full, the camera will stop taking images.

2. Check the batteries to make sure that they are new alkaline or lithium AA batteries. ***See note above about short battery life.***
3. Make sure that the camera power switch is in the “**On**” position and not in the “**Off**” or “**Setup**” modes.
4. Make sure that you are using a good quality SD card in your camera. **Bushnell recommends SanDisk® SD Cards up to 32GB (Ultra® or Extreme® series for HD video).**
5. If the SD card has its write protect switch in the lock position, the camera will not take images.
6. If you have used an SD card in another device before inserting it in your **Trophy Cam HD**, you might want to try formatting the card using the “Format” parameter in Setup mode (make sure you have backed up any important files first, as formatting will erase all previous files). In some cases, other devices may change the formatting of the SD card so that it will not work properly with the **Trophy Cam HD**.

Camera won't power up

1. Make sure that you have installed at least 4 batteries (the required minimum #) in the battery compartment, starting at the top, filling battery spaces 1-4 with no “gaps”.
Bushnell recommends using a full set of 8 or 12 Energizer® Lithium AA batteries in your Trophy Cam HD (the max. capacity for your model).
2. Make sure that the batteries are installed correctly, observing proper polarity. Always place the negative (flat) end of each battery in contact with the spring side of its slot inside the camera.
3. After moving the switch from “**Off**” to “**Setup**” or “**On**”, make sure that the switch is correctly in position to ensure the proper mode (avoid positions “between” two modes).
4. Do not move the switch directly from “**On**” to “**Setup**”—always move the switch all the way down to “**Off**” first, then back up to “**Setup**”.

Still Photo and/or Video Quality Problems

1. *Night photos or videos appear too dark*
 - a. Check the battery indicator icon to see if battery power is full. The flash will stop operating near the end of the battery life.
 - b. You will get the best results when the subject is within the ideal flash range, no farther than 60' (19m) . Subjects may appear too dark at greater distances.

- c.** Please note that when the Capture Number parameter is set higher than "1 Photo", or with very short Interval settings, some images may appear darker than others due to the quick response and rapid retriggering of the camera, allowing less time for the flash to fully recharge before firing again.
- d.** Make sure "LED Control" in the setup menu is set to "High" to ensure maximum output. You can also try setting "NV Shutter" in the menu to "Low" (slower shutter speed=brighter images, with tradeoff of increased blur if subject moves rapidly).
- e.** The ARD (anti-reflective device) shield can be removed to maximize flash output. See *page 29* for more details.
2. *Daytime photos or videos appear too dark*
Make sure that the camera is not aimed at the sun or other light sources during the day, as this may cause the auto exposure to produce darker results.
3. *Night photos or videos appear too bright*
If the subject is close to the camera (less than 10ft/3m), change the LED Control parameter in the Setup Menu to "Medium" or "Low".
4. *Daytime photos or videos appear too bright*
Make sure that the camera is not aimed at the sun or other light sources during the day.
5. *Photos with streaked subject*
a. In some cases with low lighting conditions and fast moving subjects, the 5MP or 8MP resolution settings may not perform as well as the 3MP setting.
b. If you have multiple images where fast moving subjects produce streaks on the photo, try the 3MP setting instead.
c. Set "NV Shutter" to "High" to minimize motion blur.
6. *Red, green or blue color cast*
a. Under certain lighting conditions, the sensor can become confused resulting in poor color images.
b. If this is seen on a consistent basis, then the sensor may need servicing. Please contact Bushnell customer service.
7. *Short video clips—not recording to the length set*
a. Check to make sure that the SD card is not full.

- b.** Make sure that the camera has good batteries in it. Near the end of the battery life, the camera may choose to record shorter video clips to conserve power.

Date/Time Stamp not appearing on images

Make sure that the **“Time Stamp”** parameter is set to **“On”**.

Photos Do Not Capture Subject of Interest

1. Check the **“Sensor Level”** (PIR sensitivity) parameter setting. For warm temperature conditions, set the Sensor Level to **“High”** and for cold weather use, set the sensor for **“Low”**. For variable weather, use **“Auto”**.
2. Try to set your camera up in an area where there is not a heat source in the camera’s line of sight.
3. In some cases, setting the camera near water will make the camera take images with no subject in them. Try aiming the camera over ground.
4. Try to avoid setting the camera up on small trees that are prone to being moved by strong winds.
5. Remove any limbs which are right in front of the camera lens.

PIR Sensor LED Flashes/Doesn’t Flash

1. When the camera is in the **“Setup”** mode, a special LED on the front of the camera will flash when it senses motion. This is for setup purposes only and will help the user aim the camera.
2. During use, the LED will not flash when the camera takes an image. This is to help keep the camera hidden from game.

LCD Screen Issues

1. *LCD screen powers on but no text is present.*
 - a.** After moving the switch from **“Off”** to **“Setup”** or **“On”**, make sure that the switch is correctly in position to ensure the proper mode (avoid positions **“between”** two modes).
 - b.** Do not move the switch directly from **“On”** to **“Setup”**-always move the switch all the way down to **“Off”** first, then back up to **“Setup”**.
2. *LCD screen shows a faint black line after turning from **“Setup”** to **“On”**.*

The LCD will turn off when you slide the switch to the **“On”** position. In some cases, this black line will appear and then fade in about 1 second. This is normal and the camera will function properly.

3. Screen comes on but then powers off

Make sure that you have installed the SD card correctly.

Camera won't retain settings

Make sure that you have been saving the changes to any parameter settings that you made while in Setup mode, by pressing **"OK"** after changing the setting. If you don't save your new setting after changing it, the camera will continue to use the original default setting for that parameter.

Moisture or Ants Inside Camera

1. To ensure humidity or rain is kept out of the camera, secure the DC In plug firmly in place.
2. Ants can be attracted by low level electronic vibrations, and enter through any gaps between the exterior and interior of the camera. Make sure the DC In plug is securely attached.

Field Scan (Time Lapse) not working properly

1. Make sure that the stop and start times of Field Scan "A" and "B" do not overlap (for example, do not set the start time of "B" to 8AM if the stop time of "A" is 10AM).
2. When using Field Scan in video mode, the smallest interval time available is 5 min, to avoid potential overheating of the batteries and electronic components, which could cause operational failure or damage to the camera. In still photo mode, a 1 min. Interval can be set.

Do not mix old and new batteries.

Do not mix battery types-use ALL lithium or ALL alkaline.

Rechargeable batteries are not recommended.

TECHNICAL SPECIFICATIONS

Maximum Pixel Size	3264x2448 (8MP)
Lens	F = 3.1; FOV=45°; Auto IR-Cut-Remove (at night)
IR-Flash Range	Selectable (Low/Med/High), up to 60'(19m) on High
Display Screen	Monochrome Display: 24x32mm(1.5")
Memory Card	SD or SDHC Card, Maximum capacity 32GB
Internal RAM	32MB
Picture Size	8MP = 3264x2448; 5MP = 2592x1944; 3MP = 1920x1440
Video Size	1280x720, 640x360, 320x180 (119676C/119677C) or 1920x1080, 1280x720, 640x360 (119678C) pixels per frame at 20-30 fps (Day) / 15-20 fps (Night)
PIR sensitivity	Hyper PIR with 4 sensitivity settings: Low/Normal/ High/Auto
Operation	User selectable: 24 Hour, Day only, or Night only (based on ambient light level)
Response Time	0.2 second
Triggering Interval	1 sec. - 60 min. programmable
Shooting Numbers	1-3 programmable
Video Length	5-60sec. programmable
Power Supply	8x (119676C/119677C) or 12x (119678C) AA batteries recommended, 4xAA as emergency power
Stand-by Current	< 0.25mA (<7mAh/day)
Power Consumption	250mA (+1300mA when all LEDs fire)
Night Vision Shutter Speed	User selectable (High/Med/Low)-affects night (NV) photos/videos only
Interface	USB; SD card holder; DC external (>7.5v)
Security	Strap; 1/4-20 attachment
Operating Temperature	-20 - 60°C (Storage temperature: -30 - 70°C)
Operating Humidity	5% - 90%

ONE YEAR LIMITED WARRANTY

Your Bushnell product is warranted to be free of defects in materials and workmanship for one year after the date of purchase. In the event of a defect under this warranty, we will, at our option, repair or replace the product, provided that you return the product postage prepaid. This warranty does not cover damages caused by misuse, improper handling, installation, or maintenance provided by someone other than a Bushnell Authorized Service Department.

Any return made under this warranty must be accompanied by the items listed below:

1. A check/money order in the amount of \$10.00 to cover the cost of postage and handling
2. Name and address for product return
3. An explanation of the defect
4. Proof of Date Purchased
5. Product should be well packed in a sturdy outside shipping carton, to prevent damage in transit, with return postage prepaid to the address listed below:

IN U.S.A. Send To:

Bushnell Outdoor Products
Attn.: Repairs
9200 Cody
Overland Park, Kansas 66214

IN CANADA Send To:

Bushnell Outdoor Products
Attn.: Repairs
140 Great Gulf Drive, Unit # B
Vaughan, Ontario L4K 5W5

For products purchased outside the United States or Canada please contact your local dealer for applicable warranty information. In Europe you may also contact Bushnell at:

Bushnell Germany GmbH
European Service Centre
Mathias-Brüggen-Str. 80
D-50827 Köln
GERMANY
Tel: +49 221 995568-0
Fax: +49 221 995568-20

This warranty gives you specific legal rights.
You may have other rights which vary from country to country.

©2014 Bushnell Outdoor Products

Specifications and designs are subject to change without any notice or obligation on the part of the manufacturer.

FCC COMPLIANCE STATEMENT:

This equipment has been tested and found to comply with the limits for a Class B digital device, pursuant to part 15 of the FCC Rules. These limits are designed to provide reasonable protection against harmful interference in a residential installation.

Operation is subject to the following two conditions: (1) This device may not cause harmful interference, and (2) this device must accept any interference received, including interference that may cause undesired operation.

This equipment generates, uses and can radiate radio frequency energy and, if not installed and used in accordance with the instructions, may cause harmful interference to radio communications. However, there is no guarantee that interference will not occur in a particular installation. If this equipment does cause harmful interference to radio or television reception, which can be determined by turning the equipment off and on, the user is encouraged to try to correct the interference by one or more of the following measures:

- Reorient or relocate the receiving antenna.
- Increase the separation between the equipment and receiver.
- Connect the equipment into an outlet on a circuit different from that to which the receiver is connected.
- Consult the dealer or an experienced radio/TV technician for help.

The device does not contain any user-serviceable parts. Repairs should only be made by an Authorized Bushnell repair center. Unauthorized repairs or modifications could result in permanent damage to the equipment, and will void your warranty and your authority to operate this device under Part 15 regulations.

The shielded interface cable which is provided must be used with the equipment in order to comply with the limits for a digital device pursuant to Subpart B of Part 15 of FCC Rules.



Disposal of Electric and Electronic Equipment

*(Applicable in the EU and other European countries
with separate collection systems)*

This equipment contains electric and/or electronic parts and must therefore not be disposed of as normal household waste. Instead, it should be disposed at the respective collection points for recycling provided by the communities. For you, this is free of charge.

If the equipment contains exchangeable (rechargeable) batteries, these too must be removed before and, if necessary, in turn be disposed of according to the relevant regulations (see also the respective comments in this unit's instructions).

Further information about the subject is available at your community administration, your local waste collection company, or in the store where you purchased this equipment.



For further questions or additional information
please contact:

Bushnell Outdoor Products
9200 Cody, Overland Park, Kansas 66214
(800) 423-3537 · www.bushnell.com

©2014 Bushnell Outdoor Products

Free Manuals Download Website

<http://myh66.com>

<http://usermanuals.us>

<http://www.somanuals.com>

<http://www.4manuals.cc>

<http://www.manual-lib.com>

<http://www.404manual.com>

<http://www.luxmanual.com>

<http://aubethermostatmanual.com>

Golf course search by state

<http://golfingnear.com>

Email search by domain

<http://emailbydomain.com>

Auto manuals search

<http://auto.somanuals.com>

TV manuals search

<http://tv.somanuals.com>