

**Newton Series<sup>®</sup> HD**

**CAMBRIDGE  
SOUNDWORKS<sup>®</sup>**

**MC630HD**

High Performance Loudspeaker for Flat Panel HDTVs  
User Manual

Cambridge SoundWorks, Inc.  
120 Water Street  
North Andover, MA 01845  
1-800-FOR-HIFI  
**[cambridgesoundworks.com](http://cambridgesoundworks.com) or [hifi.com](http://hifi.com)**



*Newton Series HD  
High Performance  
Loudspeaker*

**Contents**

Introduction ..... 4  
Product Contents ..... 4  
Inspecting for Damage ..... 4  
System Configuration ..... 5  
Speaker Placement ..... 5  
Wiring ..... 6  
Speaker Mounting ..... 7  
Horizontal Use ..... 8  
Bass Contour Switch ..... 9  
Enclosure Cleaning ..... 9  
In Case of Difficulty ..... 9  
Specifications ..... 10  
Dimensions ..... 10

# Introduction

Thank you for choosing a Newton HD Series speaker. The MC630HD features the finest drivers, precision internal crossover circuitry, and an elegant enclosure design.

The design team at Cambridge SoundWorks believes there is no better combination of audiophile-level attention to detail and reasonable cost.

## Contents

1. One Speaker
2. Two stick-on rubber feet
3. Four clear round stick-on rubber feet
4. Center Channel rear support
5. ¼-20 machine screw for rear support
6. Two screws and wall anchors

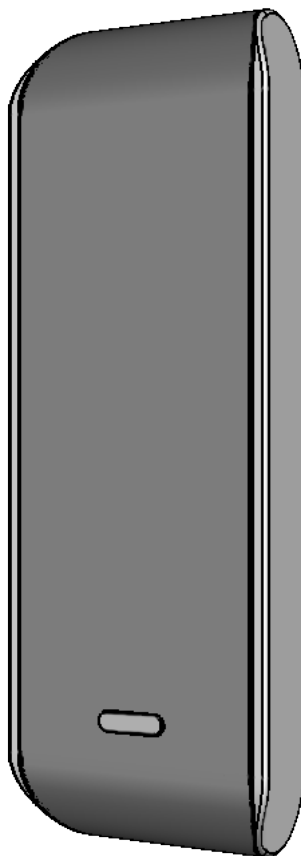
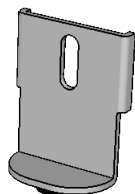

## After Unpacking

Save the shipping carton and packing material for future use and transport.

## Inspecting For Damage

Examine each part carefully for shipping damage. If there is any, do not install or use the speaker. Return the speaker to the merchant where you made the purchase or call Cambridge SoundWorks at 1-800 FOR-HIFI (1-800-367-4434) for assistance.

# System Configuration

For the most balanced performance use an MC630HD on all channels of the surround-sound system. They are also excellent to use as rear or surround speakers in a system using MC650HD front speakers. If you prefer smaller or in-wall surround and rear speakers, any of the Cambridge SoundWorks Newton Series speakers may be substituted with good results. The Left, Center, and Right speakers should all be the same for the most accurate sound stage.

The MC630HD is intended for use in systems that contain one or more subwoofers, and is not designed to reproduce the deep bass range. Use a receiver or AV processor that incorporates a high-pass crossover whenever possible. If you must use the MC630HD with a receiver or amplifier that does not contain a high-pass filter, make sure the "o" or "wall" side of the bass contour switch adjacent to the input terminals is pressed. Setting this switch to "l" or "Stand" when driven with a full-range signal can result in damage to the speaker if the signal contains strong bass.

## Speaker Placement

The proper placement of speakers affects how well the AV surround system recreates the sound field intended by the recording engineer. Current recording practice typically assumes a speaker array with a center channel speaker directly in front of the central viewing position. Left and right speakers are placed so they each form a 30 degree angle from the centerline. Left and right surround speakers should be 110 degrees from the centerline. Left and right rear speakers in a 7.1 system should be at 140 degrees. If a single rear speaker is used in a 6.1 system, it should be centered on the rear wall. Front speakers should be as close to the height of the TV monitor as practical. Surround and rear speakers should be slightly higher. Recreate this speaker pattern as closely as your room and furnishings allow.

Don't be too concerned if your situation and listening environment dictate the speakers' position. Most rooms do not allow ideal placement. Place your speakers as close to these guidelines as practical. The speakers will still provide convincing, lifelike sound.

Your surround processor has a variety of adjustments to optimize the sound based on the speakers' capabilities and placement. These adjustments vary by processor, so refer to your processor's manual for instructions specific to your equipment. Set your main, center, and surround settings to "SMALL", with subwoofer "ON". If your processor allows you to adjust the crossover frequency, set it as close to 100Hz as possible.

- Avoid placing front left and right speakers very close to a side wall (within 12-14 inches). The reflected sound from the wall degrades the sound coming directly from the speaker.

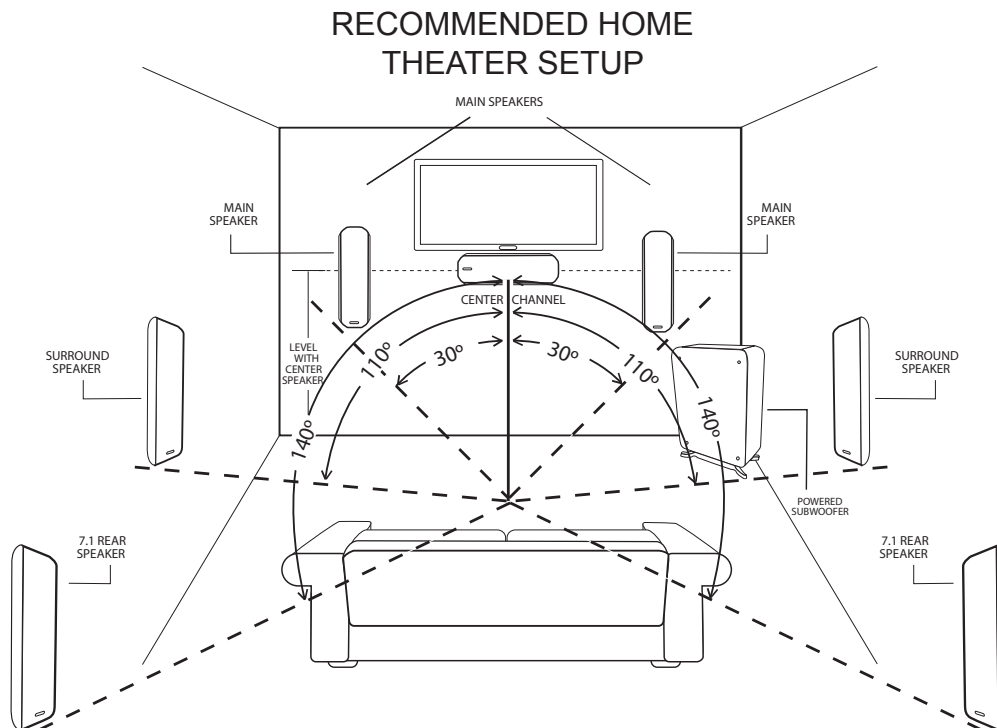

# Wiring The Speakers

If you wish to conceal the wire within the walls, it is easiest to run the wires to their final positions prior to mounting the speakers. The spring loaded terminals of the MC630HD accept bare wire between AWG #12 and AWG #18 (lower numbers are thicker). It is not necessary to "tin" the wire or use connectors to terminate the wire.

- Use at least AWG #18 speaker cable for short runs (under 15 feet). Use AWG #16 or heavier speaker cable for longer runs.
- Building codes typically require plenum rated wire for installation within walls. Be sure to use wire that complies with any applicable local building codes. Plenum rated cable typically has an outer jacket with individually insulated conductors inside the outer jacket.

## Preparing The Wires

1. Determine how long the speaker cable should be for each speaker. Cut the speaker cable into the appropriate lengths.
2. Route the wire to each speaker location.
3. Strip 1/2 inch of insulation from the two individual conductors in the speaker cable. Twist the exposed strands of bare wire together.
4. Determine which conductor you will use to connect the positive terminals of the amplifier and speaker together. Printing or a ridge on the insulation usually distinguishes one of the two conductors. Sometimes the metal of the conductors has two different colors, or the insulation color of each conductor may be different.

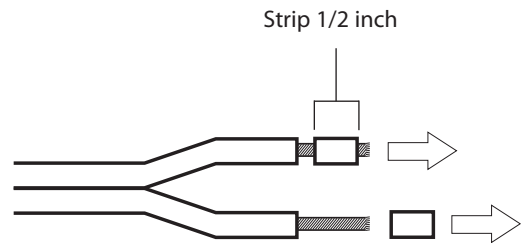

## To Attach The Wires

1. Press the speaker's red terminal to expose the hole in its shaft.
2. Insert the stripped end of one cable's positive conductor into the speaker's red (+) terminal.
3. Release the terminal to secure the connection. Make sure no stray strands of wire are present.
4. Repeat the procedure for the cable's other conductor and the speaker's black (-) terminal.
5. Connect the opposite end of the speaker cable to the speaker outputs of your receiver. Remember to observe channel and polarity (Left Positive, Left Negative, Right Positive, Right Negative).
6. Repeat the process for each speaker.

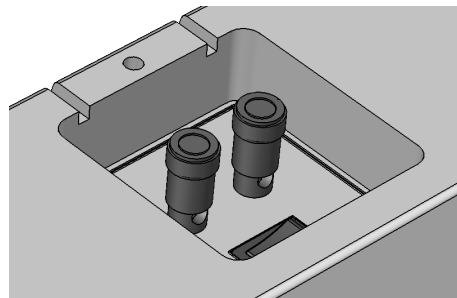

# Speaker Mounting

The MC630HD may be wall mounted or placed horizontally on a table-top as a center-channel using the included hardware. Matching floor and table-top stands are available separately from Cambridge SoundWorks.

## Hanging The Speaker On The Wall

The MC630HD may be mounted either vertically or horizontally using the supplied wall anchors.

1. Using the dimension diagram as a guide, mark the position of two locations for mounting screws and anchors. The anchors will not be needed if you can locate the speakers directly over a wall stud. If concealing the wiring in the wall, you should arrange the speakers so that the wire exits the wall directly behind the center of the speaker. Drill a  $\frac{1}{4}$ " diameter hole and install wall anchors in each location. Refer to the instructions below for proper use of the Togglor brand anchors included with this speaker.
2. Insert the #10 screws into each anchor and screw them partially in leaving approximately  $\frac{3}{8}$ " exposed. Test fit the speaker on the screws and adjust both screws so that the speaker hangs firmly on the wall without rattling.
3. Attach the wire to the speaker terminals. Slide the speaker on the screws from the top.

### **TOGGLER<sup>®</sup> BRAND AF6<sup>™</sup> ALLIGATOR<sup>®</sup> Solid-Wall Anchors**

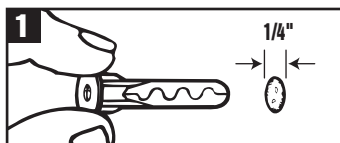

Drill  $\frac{1}{4}$ " diameter hole — minimum hole depth  $1\frac{1}{2}$ ". Insert anchor and tap flush.

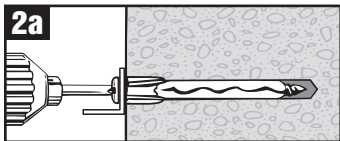

Place item over anchor. Insert screw and tighten flush. For best results use screw gun for installation in solid walls.

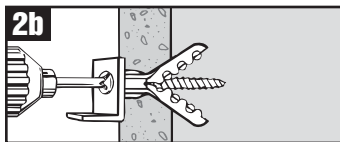

In walls of minimum thickness  $\frac{3}{8}$ ", screw opens anchor and locks securely.

Patented under U.S. Patent Nos. 4,752,170 and 5,161,296; and foreign counterparts thereof.  
Other patents pending. TOGGLER and typeface, and ALLIGATOR are worldwide registered trademarks of Mechanical Plastics Corp.  
© 2002 MPC

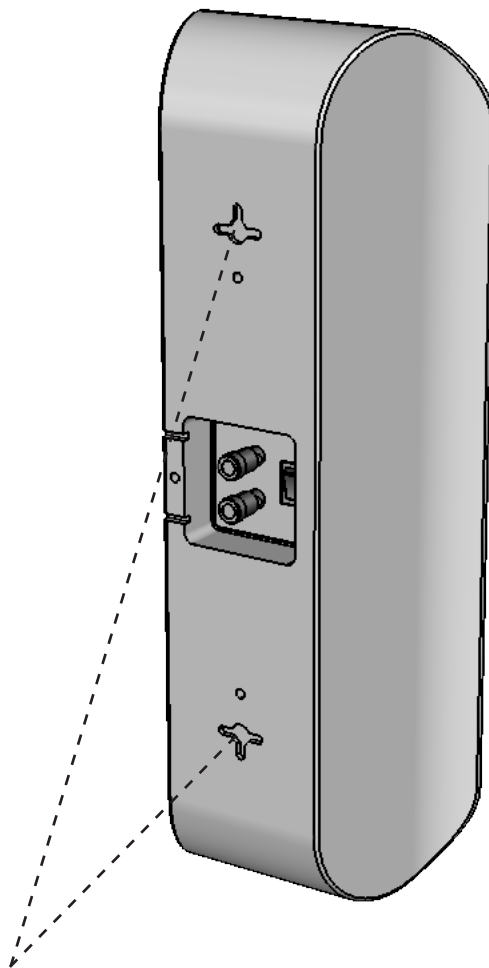

Use a keyhole slot to hang the speaker from a screwhead.

## Placing Horizontally On a Tabletop Or Shelf

1. Attach the rear support into the channel on the rear of the speaker using the included  $\frac{1}{4}$ -20 machine screw. Tighten the set-screw finger-tight to stabilize the support.
2. Attach two rubber hook-shaped stick-on feet symmetrically along the bottom edge of the speaker approximately 10" apart. If you are mounting the speaker on an uneven surface you may need to attach the feet closer to the center. Adapt the actual position to your needs.
3. Remove the logo by pulling it straight out. Turn it 90 degrees so that the text reads correctly. Press it back in place.

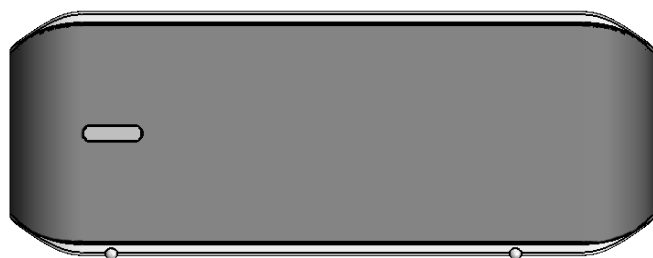
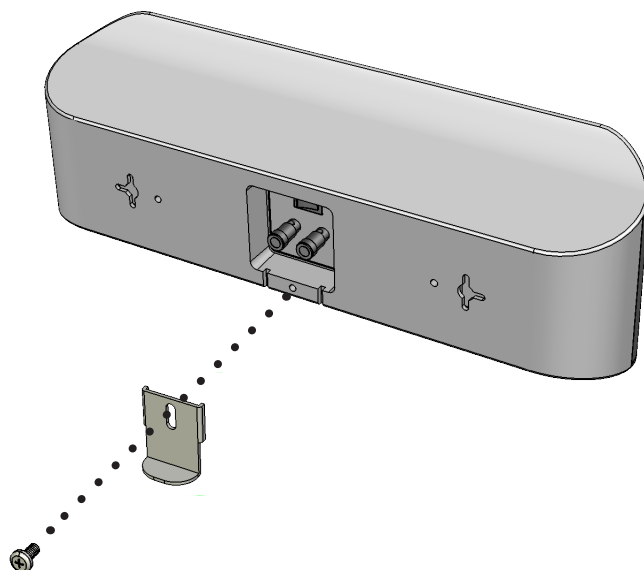

Logo Orientation

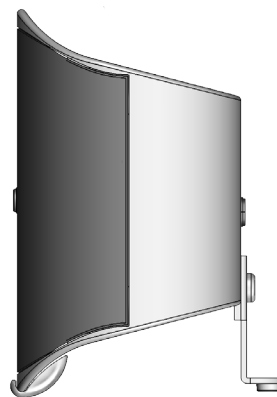

Rubber Feet



# Setting Bass Contour

The switch located near the connection terminals optimizes the low frequency response of the speaker for wall or stand mounting.

- When the speaker is mounted on a speaker stand, away from the wall press the end of the switch marked with “|”.
- When the speaker is mounted on the wall or table, press the end of the switch marked with “o”. The upper bass range will be slightly attenuated to compensate for the increase in bass caused by wall reflection.

The above recommendations should yield the most accurate response in each example, but they are optional. If you prefer the sound with settings opposite the above recommendations, feel free to use your settings instead.

**Note: Always place the switch in the “o” position if you are using amplifier or receiver that does not have a high-pass filter on the speaker outputs. Receivers and amplifiers that do not have separate subwoofer outputs are in this category.**

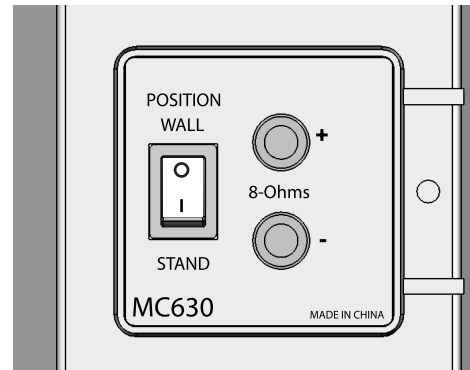

# Warning About Excessive Amplifier Distortion

The MC630HD can be safely used with any receiver rated above 30 watts per channel. There is little advantage in using more power than 100 watts per speaker, but receivers above this power rating can be used so long as the receiver is not operated at distorted levels. Operating a receiver (of any power rating) beyond its maximum undistorted output level creates distortion – added high frequency sound not part of the musical program. Distortion dramatically increases the internal operating temperature of a speaker and will eventually cause the speaker's failure due to burned or melted internal parts. While Cambridge SoundWorks includes the most heat-tolerant parts commensurate with good acoustic design, the speaker's Limited Warranty against defects in materials or workmanship does not apply to parts that fail from long-term operation at very high temperatures.

# Enclosure Cleaning

The speaker enclosures can be cleaned with a soft, damp cloth or mild cleaner. Brush or vacuum the grille panels with a soft brush attachment to your vacuum cleaner.

# In Case of Difficulty

If you suspect there is a problem with your *Newton HD* loudspeaker, contact the retailer where it was purchased or a Cambridge SoundWorks Audio/Video Consultant, who will help you track down the problem. If together you agree there is something wrong with your *Newton HD* loudspeaker, return it to the retailer that sold it to you. Mail-order and Internet retailers will generally require a Return Authorization number. Products purchased from a Cambridge SoundWorks store, you may call us for a factory Return Authorization. **Do not return the *Newton HD* loudspeaker or any parts without first obtaining a Return Authorization.**

# Specifications

Dimensions:	17 5/16" H x 6 1/2" W x 3 7/8" D
Weight:	14 pounds each
Impedance:	nominal 8 ohms
Recommended amplifier power range:	20W – 100W RMS per channel
Frequency Range:	80Hz – 24kHz
Woofer Type:	2 x 4" with co-injection molded composite cones and butyl-rubber surrounds
Tweeter Type:	3/4" aluminum dome with ferrofluid-damping and neodymium magnet
Crossover:	2 way, series-connected
Enclosure:	High-density pressure-cast aluminum with molded-composite baffle

## Dimensions

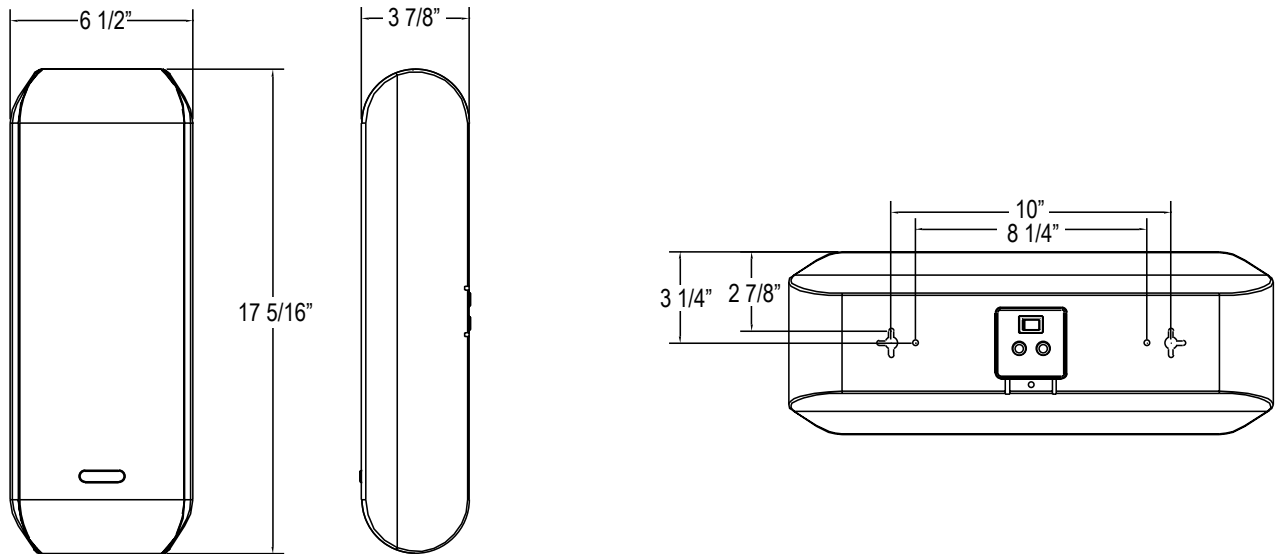



**CAMBRIDGE  
SOUNDWORKS®**  
A CREATIVE® Company

120 Water Street  
North Andover, MA 01845  
(800) FOR-HIFI  
(1-800-367-4434)  
[www.cambridgesoundworks.com](http://www.cambridgesoundworks.com)  
email: [info@cambridgesoundworks.com](mailto:info@cambridgesoundworks.com)

P81-2460

## Free Manuals Download Website

<http://myh66.com>

<http://usermanuals.us>

<http://www.somanuals.com>

<http://www.4manuals.cc>

<http://www.manual-lib.com>

<http://www.404manual.com>

<http://www.luxmanual.com>

<http://aubethermostatmanual.com>

Golf course search by state

<http://golfingnear.com>

Email search by domain

<http://emailbydomain.com>

Auto manuals search

<http://auto.somanuals.com>

TV manuals search

<http://tv.somanuals.com>