

07/5/68

Canon 514XL

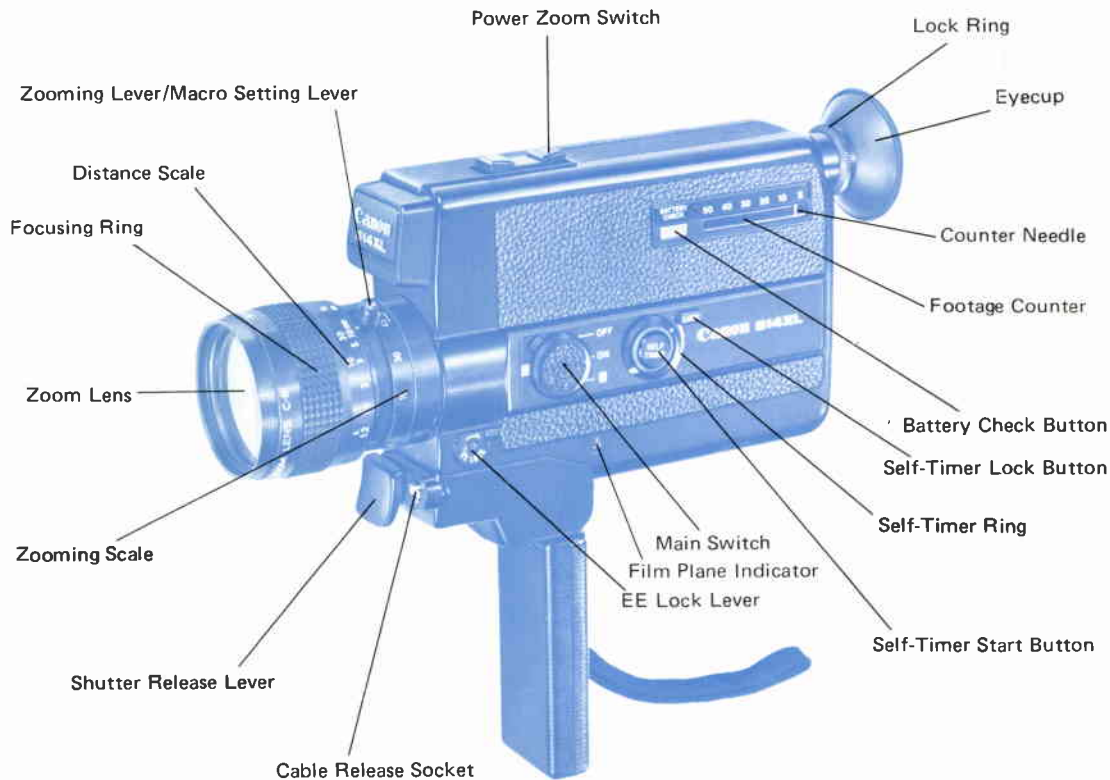

INSTRUCTIONS



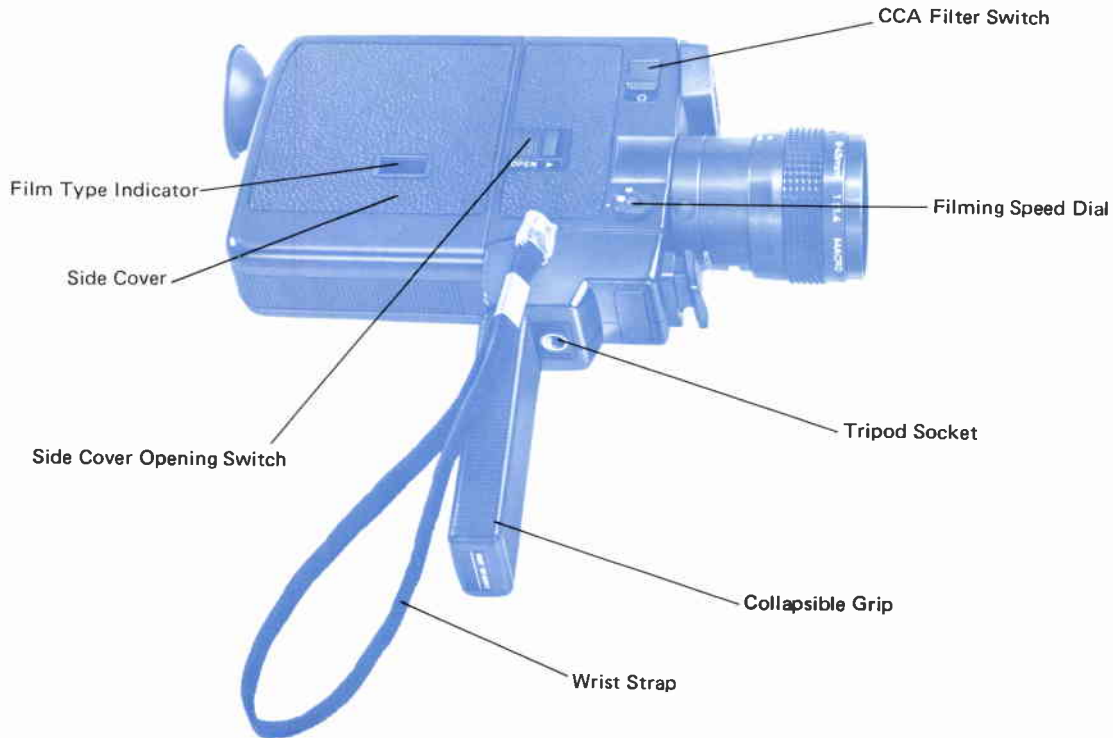

Canon 514XL Features

The Canon 514XL embodies Canon's highest quality ideal with an emphasis on compactness and easy use. The Canon 514XL offers all the 8mm zoom features and was developed only after long and involved research. In spite of the large aperture $f/1.4$ and high 5X zoom ratio of the lens, it is as compact as a 3X zoom camera with a slim body.

This instruction booklet was written for your convenience, to be used to thoroughly familiarize you with the operations of your new 514XL. We suggest you keep it on hand and refer to it frequently until you are fully acquainted with its great potential.

- **XL System That Enables Filming in Dim Light**

'XL' is an abbreviation for "existing light". Cameras with this XL system enable photography without any additional illumination even under dimly lit conditions.

The Canon 514XL is a high quality XL camera with a high speed lens, wide angle of shutter opening and high speed meter.

- **Compact Zoom Lens with Large Aperture**
Despite the fast $f/1.4$ and the high 5X zoom ratio, the size of this lens is the same as that of a 3X zoom lens. The diameter of the filter is 43mm. The sharpness of the picture image is outstanding and you will surely be satisfied with the resulting movies.

- **Light, Slim and Handy Body**
Even with all the newly developed mechanisms, the Canon 514XL has a light and small body which is very handy for such occasions as travel. This slim body is the result of all possible considerations in designing the optical system, power source, and drive system, etc.

- **(From candlelight out into the sun)
Light Metering of Wide Range**

An XL camera requires an exposure meter which is capable of measuring a wide range. This camera has an exposure meter which enables accurate light metering at either dimly lit or bright places. The light measuring range is enlarged for both the bright side and dark side.

- High-Precision Viewfinder

You can focus accurately even in dimly lit places because of the bright and accurate viewfinder.

- The Viewfinder Gives All Filming Information

The single lens reflex viewfinder is free of parallax and has all the necessary information for filming. The split-image screen for focusing, aperture scale, the under/overexposure warning marks, battery check lamp and film transport indicator can be all checked at a glance.

- Wide Angle and Telephoto Macro Mechanism

With the Canon 514XL, you can switch to macrophotography from either wide angle or telephoto, whereas conventional cameras only enabled macrophotography in one of these settings.

- Built-in Self-timer

Compact and slim the 514XL has a self-timer which enables the photographer himself to be in the picture.

- Additional Features

The concentrated power system of two pen-light batteries, single frame shooting, convenient EE (AE) lock mechanism for shooting against the light, and the eyepiece adjustment system.

Specifications

Type: SLR type Super 8 with XL mechanism.

Size of Picture Frame: 5.8 x 4.2mm.

Lens: f/1.4, 9mm—45mm focal length, 5X zoom ratio.

Macrophotography Mechanism: It can be switched to wide-angle macrophotography or telephoto macrophotography by the zooming lever.

- 1) (Wide angle macrophotography) When the distance scale is set to ∞ , close-up shooting at approx. 227mm from the film plane indicator is possible. The field size is approx. 74 x 102mm.
- 2) (Telephoto macrophotography) When the distance scale is set to ∞ , it is possible to film at a distance of approx. 600mm from the film plane indicator. The field size is approx. 44 x 61mm.
- 3) Macro focusing is possible by rotating the zooming lever.

Lens Construction: 13 elements in 11 groups, Spectra coating; filter thread size: 43mm, lens cap size: 45mm.

Viewfinder: Single lens reflex, split-image viewfinder. Information: split-image screen for focusing, aperture scale, the under/overexposure warning marks, battery check lamp, film transport indicator.

Dioptric adjustment from -4 to +2 dpt., with

lockable eyecup.

AE mechanism: Automatic exposure mechanism coupled to film speed and filming speed. Through-the-lens AE with CdS photocell.

Light Metering Range: ASA 250, f/1.4, 9 fps. to ASA 25, f/32, 18 fps. Coupled to single frame.

Film Speed:

For artificial light: ASA 40, 160, 250.

For daylight: ASA 25, 100, 160.

Film Speed Setting: Automatically set when cartridge is loaded.

Color Temperature Adjustment CCA Filter: Built-in. Automatic cancellation when daylight type film cartridge is inserted.

Manual removal is also possible with switch located on the outside of the camera body.

Filming Speeds: 9 fps, 18 fps and single frame.

Angle of Shutter Opening: 220°.

Switch: With three positions: "ON", "OFF" and single frame.

Manual Exposure Operation: The exposure value is fixed by EE lock lever.

Drive System: Film drive with high-performance electric micromotor.

Battery Check: LED lamp in the viewfinder.

Power Source: Two 1.5V penlight batteries, loaded

into the upper part of the body. The power source is used for the drive system, power zooming, and exposure metering.

Zooming System: Power zooming by electric motor and manual zooming.

Power zooming speed: about 8 seconds.

Self-timer: After charging the self-timer, it is started by pressing the start button. With about a 10 second lag and about 10 seconds of filming.

Number of Films: Sufficient for 5 cartridges under normal temperature conditions; one cartridge under normal temperature conditions in single frame shooting.

Footage Counter: Automatically returns to S and counts footage of exposed film. Coupled to the cartridge loading.

Grip: Collapsible.

Safety Mechanisms: Safety switch, film transport indicator, battery check lamp, self-timer lock button, etc.

Dimensions and Weight: 190.5 x 112 x 39mm
(7-1/2" x 4-3/8" x 1-1/2")
620g (including batteries) (1 lb. 6 ozs.)



Subject to change without notice.

Canon 514XL

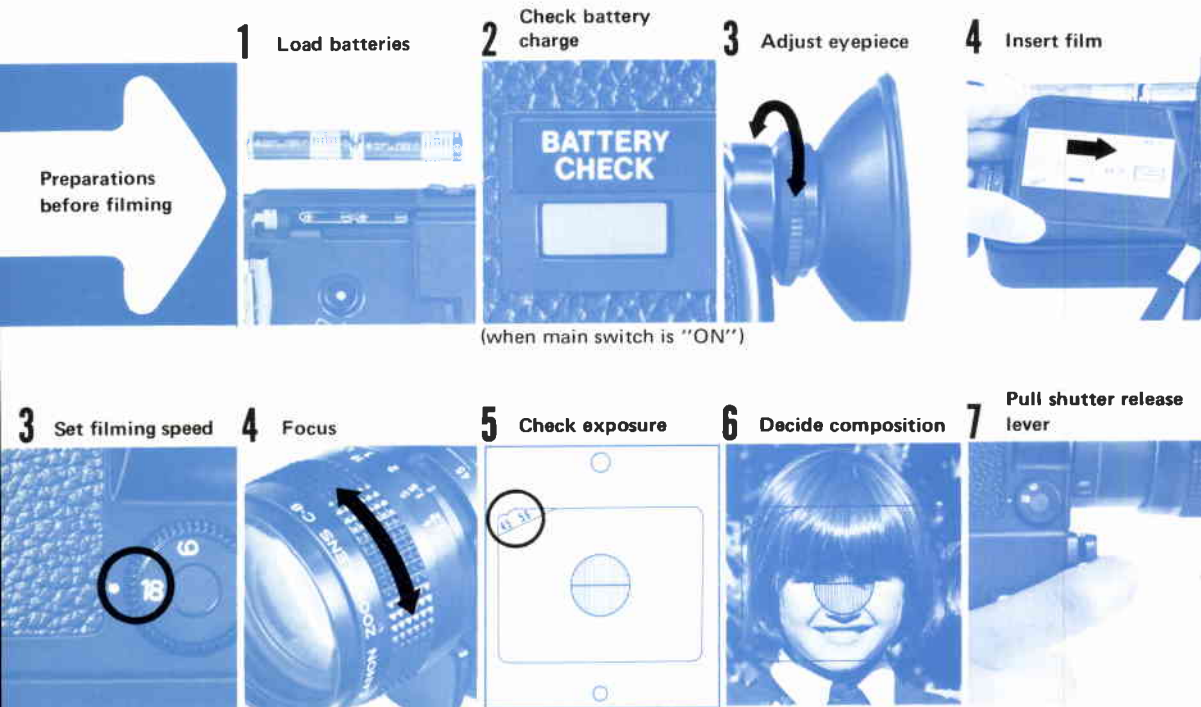

5 Check film advance

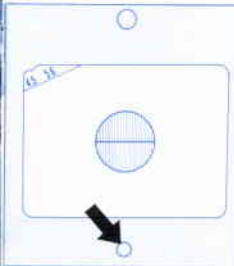

(when main switch is "ON")

6 Check setting of CCA filter

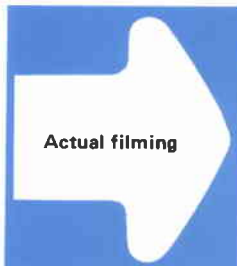

1 Unfold grip



2 Turn main switch to "ON"

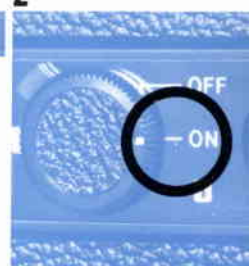

8 Zoom as desired

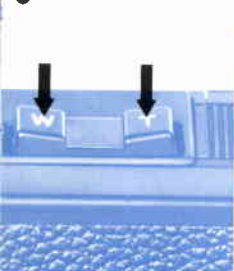

9 Remove film cartridge after film ends



10 Turn main switch to "OFF"

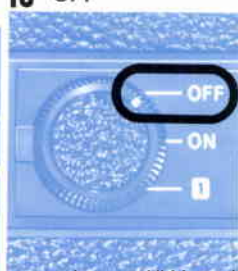

Preparations Before Filming

Although this camera has a mechanism which automatically sets film speed once the film is loaded, some operations require that you familiarize yourself with the various camera parts and how they operate, before you go on to actual filming. This is indispensable for film making without any mistakes and to make it more enjoyable.

1 Handling the Grip and Strap

The grip is very useful for carrying and is collapsible. When it is used, it can be pulled out as the picture shows and it can be folded back when not in use. For shooting, put your hand through the strap and hold the grip.

2 Opening and Closing the Film Compartment

This compartment opens by pushing the side cover opening switch as indicated by the arrow. To close, simply push the cover in and it will snap in place.

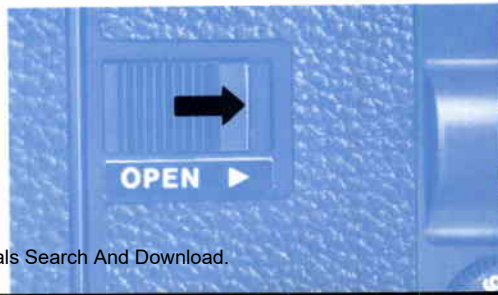

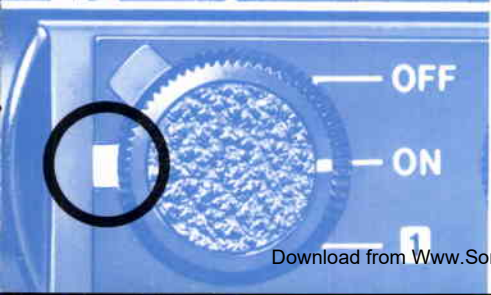
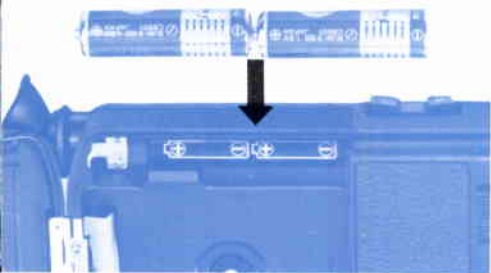

3 Loading the Batteries

This camera's film advance, power zooming and exposure metering are powered by two 1.5V penlight batteries. New batteries of a reputable brand will assure good performance of all electrically powered functions.

Please make sure that both new batteries are of the same brand for efficient operation of the camera.

- Open the side cover and load the batteries as the chart shows in the battery compartment.

Filming Capacity in Normal Temperature Conditions

- 1) Normal shooting more than 5 cartridges
 - 2) Single frame shooting. . . more than 1 cartridge
- * If the camera will not be used for a prolonged period, remove the batteries and store them in a dry place.

The main switch

All the power circuits are operated by this switch. At "ON", the power circuit is connected. At "OFF", neither the battery checker, exposure meter nor power zooming will operate. When at "ON", batteries will be functioning, so when not in use, please make sure to leave the switch at "OFF". The switch has a red mark to warn when it is at "ON".

4 How to Check the Batteries

If the voltage of batteries is low, filming cannot be performed correctly, so please check them.

- Turn the main switch to "ON" and press the battery check button as you look into the viewfinder. If the red lamp lights on at the upper part, it can be used. If the lamp does not light, replace the batteries with new ones.

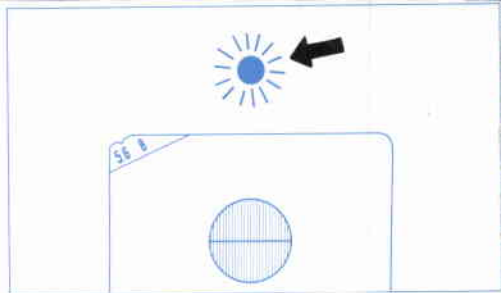

5 How to Perform Eyepiece Adjustment

Please adjust to your eyesight. If not correctly adjusted, it may result in out-of-focus pictures.

- Set the distance scale at ∞ , point the camera to the sky and adjust the eyepiece. By turning the lock ring to loosen it, rotate the eyecup. Adjust so that the line of the split-image screen in the center of the viewfinder is clearest and fix it in that position.
- The possible compensation is from -4 to $+2$ diopters.





6 How to Set the Filming Speed

There is a choice of three filming speeds: 9 and 18 fps. and single frame. 18 fps. makes for more natural movement when projected.

Filming speed is changed by matching the scale to the white dot. In movies taken at 9 fps. movements appear at double the normal speed when projected. 9 fps. will emphasize the movement and will be effective to make it comical or when shooting a subject with no movement under dim light, because then the exposure can be adjusted.

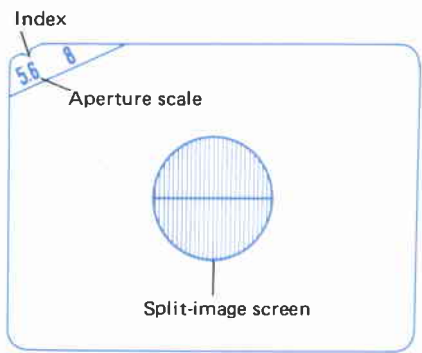
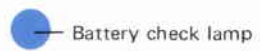

Film transport indicator



7 The Viewfinder

The viewfinder has all the necessary information. It has the split-image screen in the center, the aperture scale on the upper left and the under/overexposure warning marks on the aperture scale.

It has also the battery check lamp and the film transport indicator indicated outside the field of view.

8 Focusing

Focusing is done by rotating the focusing adjustment ring and within the circle at the center of the viewfinder. When both upper and lower images within the circle match, it is focused correctly.

Please focus at the focal length of 45mm, and then adjust to the necessary frame size by rotating the zooming lever.



out of focus



in focus

9 Zooming

The focal length of this zoom lens varies from 9mm to 45mm and can be changed continuously within that range. This is called zooming.

If zooming is done while shooting, it will make the film more exciting. Both power zooming and manual zooming are possible.



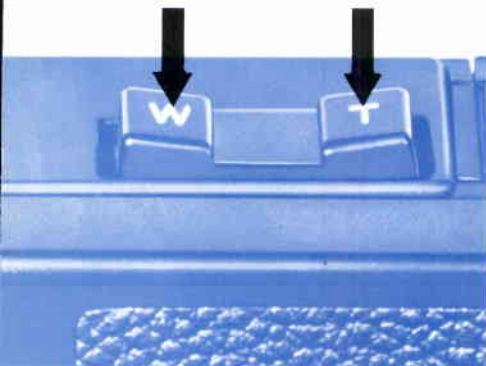

Power Zooming

When the zooming switch is pressed during filming, power zooming is accomplished. If you press the T button, the subject will be enlarged and if W is pressed, it will become smaller. When the motion stops, it will not go any farther even if the switch is kept pressed. Zooming time is about 8 seconds.



Manual Zooming

Although the power zooming speed is fixed, if you would like to change the zooming speed you can use manual zooming.

Use the zooming lever/macro setting lever to zoom, but do not pull the macro setting lever unless you wish to zoom into the macro range.

Within one movie, only one or two cuts of zooming will be adequate for appreciation. Too much zooming will make the movie difficult to look at.

10 CCA Filter



The Super 8 camera is made generally so as to allow filming with type A film (tungsten type) in daylight conditions.

Therefore there is a CCA filter built-in for adjustment of color temperature within the optical path of the lens. When shooting in daylight, the filter is used, on the other hand, when shooting indoors with artificial light, the filter should be removed from the optical path.

However, when the G type film for both daylight and artificial light or daylight type film is loaded into this camera, the filter is automatically cancelled no matter what the position of the filter switch is.



Settings of the CCA Filter

When you are using type A film (tungsten type), the CCA filter has to be set differently according to the kind of light source.

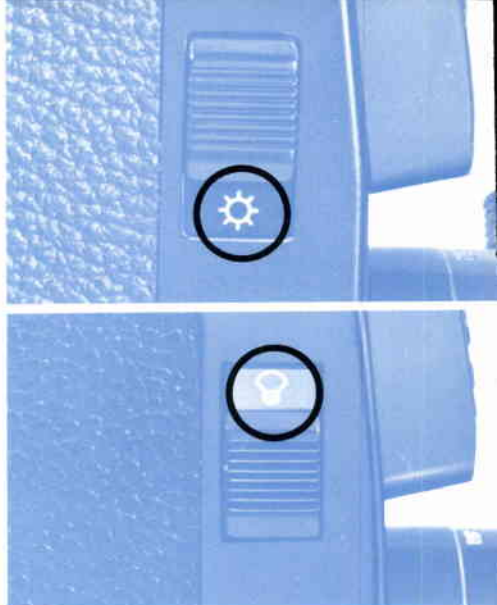
Under artificial light, slide down the filter setting switch until the  mark is visible, then the filter is cancelled. In daylight, slide up the switch until the  mark is indicated. It is impossible to obtain the proper color balance unless this is done.



CCA Filter Settings

Light Source	Daylight	Artificial Light
Film Type		
A Type (Tungsten Type)		
Daylight Type or G Type	Both position can be used.	



11 Film Loading

Insert the cartridge from the end with the film label facing outward as the picture on the left shows. When using tungsten type film, please make sure to set the CCA Filter Switch.

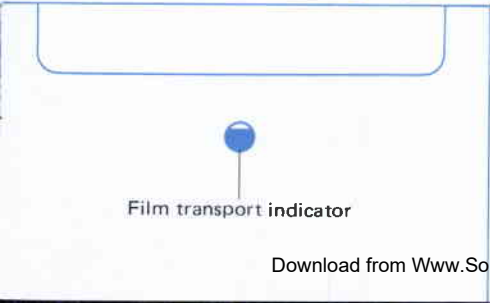

12 Checking Film Advance

Turn the main switch to "ON" and while looking through the viewfinder press the shutter release lever. If the film transport indicator moves up and down, it is normal. If it doesn't, please take out the cartridge and advance the film a little. Then load it again.

13 How to Hold the Camera

Some ways of holding the camera will cause blurred movies or shooting out of focus, so please make sure to hold the camera correctly. The fundamentals of holding the camera are to put your hand through the strap and to grasp the grip. Use the other hand for zooming or focusing on the upper part of the camera. Also, when holding the camera, press your right elbow firmly against your body to prevent blur. Keep your feet slightly apart. If you are panning, do so only by turning the upper body only from side to side. The ideal, when possible, is to use a tripod and cable release in order to avoid blur.

* When using a tripod, choose a durable one which has soft rubber caps on the tips of tripod's legs.

14 Checking the Exposure and the Under/Overexposure Warning Marks

If you set the main switch to "ON", the aperture scale board within the viewfinder will move and the accurate exposure at the time will be shown under the index. Also, when the subject is extremely bright or either dark, the exposure warning mark will be indicated on both ends of the aperture scale board. However, correct shooting is still possible until the red mark goes completely beyond the index.

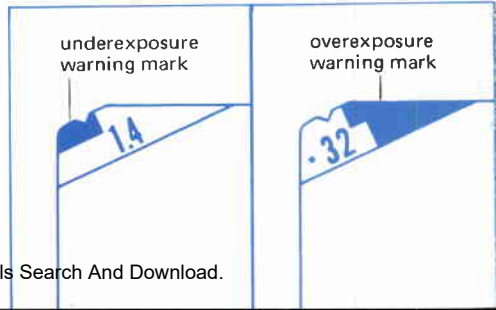
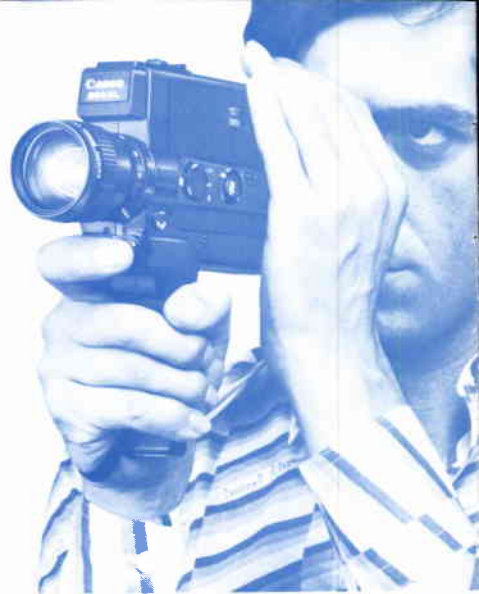

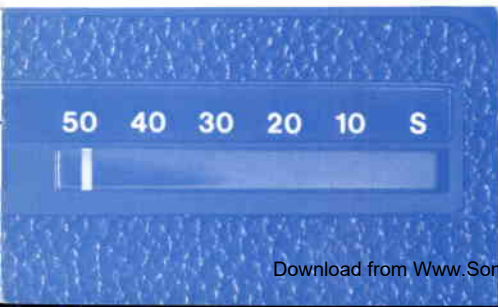
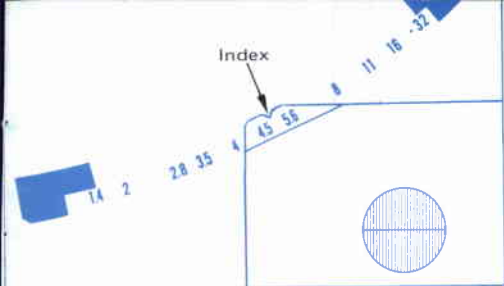

If the red mark appears when filming in dim light and the exposure is below $f/1.4$, use additional lighting.

When shooting outdoors, if the f /stop goes beyond $f/32$ and the red mark is visible, use an ND filter in front of the lens.

Generally for shootings outdoors in daytime, the use of low-speed film is advisable. If you are using high speed film and the red mark is visible, please change the film. Only about 6 frames will be wasted. It becomes impossible to read the film counter for the changed film, so please confirm that the film has ended by regarding the film transport indicator.

* When shooting out-of-doors in daylight with high speed film (ASA 160) if the red mark is indicated, please use the ND Filter 4 or 8. Don't use two filters together.

15 Film Transport Indicator and Film End

While shooting, the film transport indicator moves up and down to indicate normal film transport. When the film ends, it automatically stops. Therefore, if the indicator stops while filming, please check that the film counter scale is at 50, and take the film out.

* Exposed film can be distinguished by the holes in the perforations.

16 Exposure Control when Shooting Against Light

If there is a bright light source behind the subject as when shooting against the light, the main subject will be blacked out and underexposed.

Under this situation, the EE lock lever is used for shooting, and correct exposure will be obtained.

- 1) First point the camera away from the subject and measure the exposure.
- 2) Maintaining this exposure, while pressing the EE lock lever, point the camera toward the subject and shoot.

The exposure will be fixed while the EE lock lever is pressed down, but it will return to the initial position when your finger is removed.

This shooting with a locked exposure can be also used effectively for subjects whose brightness changes suddenly.

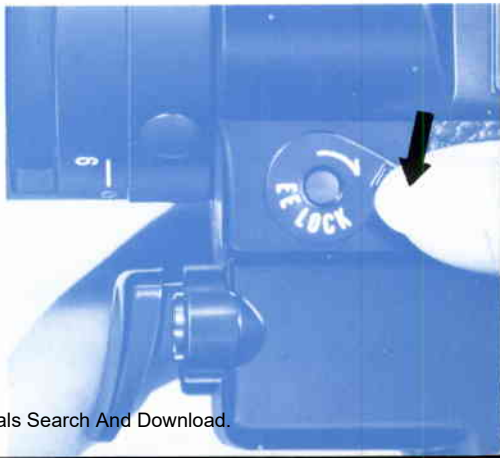

	Photography distance from the Film plane indicator (approx.)	Field size (approx.)
Wide angle macrophotography	227 mm	74 x 102mm
Telephoto macrophotography	600 mm	44 x 61 mm

17 Macrophotography

Although conventional macrophotography was possible only in either wide angle or in telephoto photography, this camera makes it possible in both.

Telephoto macrophotography is very effective for photography that requires light or for subjects that you can't get close to since it enables you to photograph at a distance. Use for shooting small animals and plants, and observing insects.

Also, wide angle macrophotography is useful for title shooting and copy work.

The relationship between the distance and the field size is as the chart shows when the distance scale is set to ∞ .

* For macro shooting, use an f/number greater than f/5.6.

Setting to macrophotography is done by turning the macro setting lever to either 9 or 45, pulling out the lever without changing its position, then turning it to the yellow line area. To release from macrophotography setting, the lever is simply pushed back. Focusing is done by turning the macro setting lever instead of the focusing ring while looking through the viewfinder.

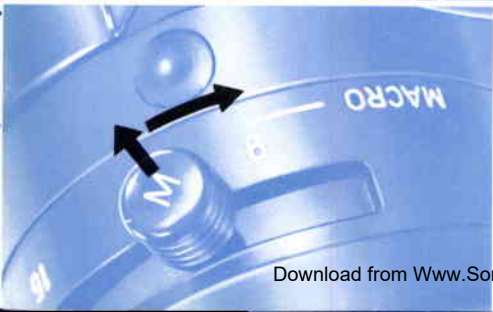

18 Macrophotography with a Zoom

Since the macro setting lever is adjusted to function only along the macro indication line, the focus will change gradually from the closest distance set on the focusing ring to the farthest as the lever is pushed. If it is operated as it should be, you will zoom in on the subject.

19 Single Frame Shooting

Single frame shooting is very effective to show in a short time changes that happen over a period of time or when shooting animations. First, set the filming speed dial to "18" and set the main switch to "1". Each time you press the shutter release lever, the camera will shoot one frame. Exposure is, of course, decided by AE.

When shooting a single frame sequence, it is necessary to calculate the number of frames necessary for the sequence. For example, if you wish to show the blooming of a flower which takes an hour to bloom, in 5 seconds on the screen the number of frames necessary is 5 times the projection speed, usually 18 fps. Therefore 90 frames must be taken over the one hour period, or one frame every 40 seconds.



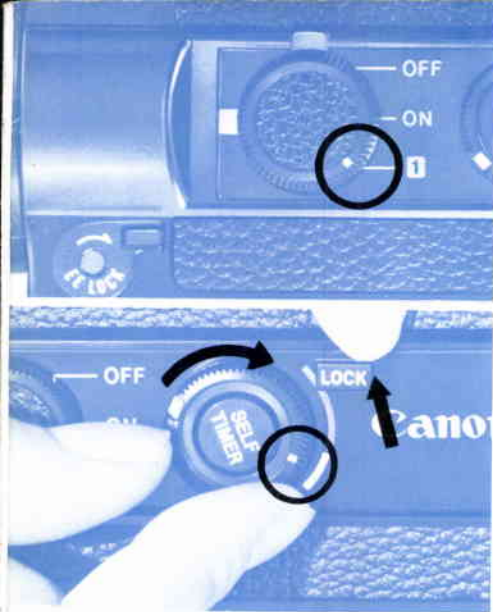

- * If the battery goes out in single frame photography, first turn the switch to "OFF", and then change the battery.

20 Self-timer Photography

When you want to film and appear in the scene you are shooting, please use the self-timer.

1. Press the self-timer lock button and turn the self-timer ring clockwise all the way.
 2. As the center self-timer start button is pressed, about 10 seconds of shooting will follow a 10 second lag.
- * When the main switch is set for single frame photography, never film using the self-timer for fear of damaging the camera.
 - * Do not activate the shutter release lever after setting the self-timer. It will not be possible to obtain the proper exposure.

21 Filters

Use 43mm filters for both color films and black and white films.

Type: UV, Skylight, CCA 4, CCA 8, CCA 12, CCB 4, CCB 8, CCB 12, ND 4, ND 8, ND 4-L, ND 8-L.



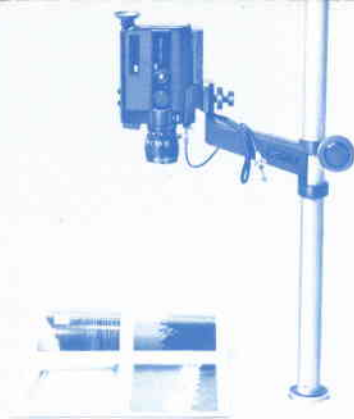

22 Copy Stand 4 and 5

Copy Stand 4 and 5 are convenient for macrophotography, title shooting and copy work.



23 C-8 Wide Attachment Lens 43

This is an attachment lens for super wide-angle shooting. If only adjusting the macro setting lever to the wide-angle macro position and attaching the lens on the camera, you can easily perform super wide-angle shooting with the fixed focal length of 5.9mm. When the exposure is more than f/4, the focal length is most suitable at 0.8m to ∞ , so you can concentrate on photographing without worrying about focusing.

Maintenance of the Camera

The accumulation of tiny film fragments and dust particles at the film gate may stain the film. Clean the film gate occasionally by whisking off foreign materials with a soft brush or blower.

When storing the camera, take it out from the case and put it in a dust-free, dry place. Do not place the camera near camphor or naphthaline. It is better for the camera to be used occasionally than to store it away for a long time.

Have your camera checked at one of the Canon authorized service facilities at least once every three years. Also, when the camera is not in use, take out all the batteries inside.

Never touch the lens surface with your fingers. Whisk any dust on the lens off with a blower or soft brush. If you get fingerprints on it inadvertently, wipe them off lightly with a silicone cloth.

If you drop the camera into the sea, it will probably not be reparable but nevertheless please consult your nearest Canon service facility.

After completion of your shooting and when placing your camera into the case, please make sure to turn the On-Off switch on your camera to the "Off" position.

It is extremely damaging for the camera to be left in high temperatures. The temperature in the rear window and trunk of a car can rise to over 60°C.

When you shoot without placing your eye on the eyepiece, be sure to put the finder cover on the eyepiece to prevent light from coming through it.

*For reference in case of theft, keep a record of the serial number of your camera.

Canon

CANON INC. 7-1, Nishi-shinjuku 2-chome, Shinjuku-ku, Tokyo 160, Japan
Mailing address: P.O. Box 5050, Dai-ichi Seimei Building, Tokyo 160, Japan

- U.S.A. — **CANON U.S.A., INC. HEAD OFFICE**
One Canon Plaza, Lake Success, Long Island, N.Y. 11042, U.S.A.
CANON U.S.A., INC. MANHATTAN SERVICE STATION
600 Third Avenue, New York, N.Y. 10016, U.S.A.
CANON U.S.A., INC. ATLANTA OFFICE
6380 Peachtree Industrial Blvd., Norcross, Georgia 30071, U.S.A.
CANON U.S.A., INC. CHICAGO OFFICE
140 Industrial Drive, Elmhurst, Illinois 60126, U.S.A.
CANON U.S.A., INC. LOS ANGELES OFFICE
123 Paularino Avenue East, Costa Mesa, California 92626, U.S.A.
CANON U.S.A., INC. LOS ANGELES SERVICE STATION
3321 Wilshire Blvd., Los Angeles, California 90010, U.S.A.
CANON U.S.A., INC. SAN FRANCISCO SERVICE STATION
776 Market Street, San Francisco, California 94102, U.S.A.
CANON U.S.A., INC. HAWAII OFFICE
Bldg. B-2, 1050 Ala Moana Blvd., Honolulu, Hawaii 96814, U.S.A.
- CANADA — **CANON CANADA INC. HEAD OFFICE**
3245 American Drive, Mississauga, Ontario L4V 1N4, Canada
CANON CANADA INC. MONTREAL SERVICE CENTRE
10652 Côte de Liesse, Lachine, Quebec H8T 1A5, Canada
CANON CANADA INC. CALGARY OFFICE
2828, 16th Street, N.E. Calgary, Alberta T2E 7K7, Canada
CANON CANADA INC. EDMONTON SERVICE CENTER
5222-86 St. Edmonton, Alberta T6E 5J6, Canada
- EUROPE AFRICA
& MIDDLE EAST — **CANON AMSTERDAM NV**
P.O. Box 7907, 1008 AC Amsterdam, The Netherlands
CANON AMSTERDAM NV CAMERA SERVICE CENTER
Distribution Center, Lemmerbergweg 31, P.O. Box 12814
1100 AV Amsterdam, The Netherlands
- CENTRAL &
SOUTH AMERICA — **CANON LATIN AMERICA, INC. DEPTO. DE VENTAS**
Apartado 7022, Panamá 5, República de Panamá
CANON LATIN AMERICA, INC. CENTRO DE SERVICIO Y REPARACION
Apartado 2019, Zona Libre de Colón, República de Panamá
- SOUTHEAST ASIA — **CANON HONGKONG TRADING CO., LTD.**
Golden Bear Industrial Centre, 7/F, 66-82 Chai Wan Kok Street,
Tsuen Wan, New Territories, Kowloon, Hong Kong
CANON SINGAPORE PTE. LTD.
Unit 605, Delta House 2, Alexandra Road, Singapore 0315
- OCEANIA — **CANON AUSTRALIA PTY. LTD.**
22 Lambs Road, Artarmon, Sydney 2064, Australia

Free Manuals Download Website

<http://myh66.com>

<http://usermanuals.us>

<http://www.somanuals.com>

<http://www.4manuals.cc>

<http://www.manual-lib.com>

<http://www.404manual.com>

<http://www.luxmanual.com>

<http://aubethermostatmanual.com>

Golf course search by state

<http://golfingnear.com>

Email search by domain

<http://emailbydomain.com>

Auto manuals search

<http://auto.somanuals.com>

TV manuals search

<http://tv.somanuals.com>