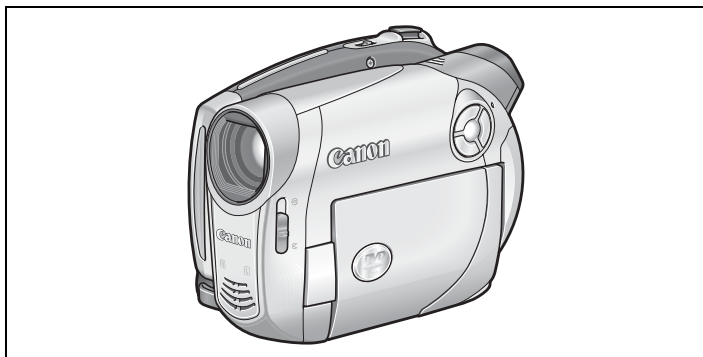

Canon

DVD Camcorder Instruction Manual

English

DC201/DC210/DC211

**Introduction****Preparations****Basic
Functions****Advanced
Functions****Editing
Functions****Playing Back
the Disc on an
External Device****External
Connections****Additional
Information****PAL**

Important Usage Instructions

WARNING!

TO REDUCE THE RISK OF ELECTRIC SHOCK, DO NOT REMOVE COVER (OR BACK). NO USER SERVICEABLE PARTS INSIDE. REFER SERVICING TO QUALIFIED SERVICE PERSONNEL.

WARNING!

TO REDUCE THE RISK OF FIRE OR ELECTRIC SHOCK, DO NOT EXPOSE THIS PRODUCT TO RAIN OR MOISTURE.

CAUTION:

TO REDUCE THE RISK OF ELECTRIC SHOCK AND TO REDUCE ANNOYING INTERFERENCE, USE THE RECOMMENDED ACCESSORIES ONLY.

CAUTION:

DISCONNECT THE MAINS PLUG FROM THE SUPPLY SOCKET WHEN NOT IN USE.

The Mains plug is used as the disconnect device. The Mains plug shall remain readily operable to disconnect the plug in case of an accident.

While using the compact power adapter, do not wrap it or cover it with a piece of cloth, and do not place it in confined narrow spaces. Heat may build up, the plastic case may deform and it could result in electric shock or fire.

CA-570 identification plate is located on the bottom.



Using any device other than the Compact Power Adapter CA-570 may damage the camcorder.

This product has been classified under IEC60825-1:1993 and EN60825-1:1994.

CLASS 1 LASER PRODUCT

European Union (and EEA) only.

This symbol indicates that this product is not to be disposed of with your household waste, according to the WEEE Directive (2002/96/EC) and your national law. This product should be handed over to a designated collection point, e.g., on an authorized one-for-one basis when you buy a new similar product or to an authorized collection site for recycling waste electrical and electronic equipment (EEE). Improper handling of this type of waste could have a possible negative impact on the environment and human health due to potentially hazardous substances that are generally associated with EEE. At the same time, your cooperation in the correct disposal of this product will contribute to the effective usage of natural resources. For more information about where you can drop off your waste equipment for recycling, please contact your local city office, waste authority, approved WEEE scheme or your household waste disposal service. For more information regarding return and recycling of WEEE products, please visit www.canon-europe.com/environment. (EEA: Norway, Iceland and Liechtenstein)

How to select a DVD disc

There are many types of DVD discs but this camcorder uses only the following three types of 8 cm mini DVD discs: DVD-R, DVD-R DL and DVD-RW. Note that what you can do with a disc depends on the type of DVD used so select the disc that best fits your purpose.

DVD-R

Best for Compatibility

DVD-Rs can be recorded only once - you cannot edit or delete the recordings. On the other hand, these discs are comparatively cheaper and they can be played back in most common DVD players.

DVD-R DL

Best for Recording Time

Dual-layered discs allow writing up to 80% more data (2.6 GB) on a single recording side. However, DVD-R DLs can only be played back on DVD devices compatible with dual-layered discs. Also, you cannot edit or delete the recordings.

Dual-layered discs have two recording layers. The camcorder will record on Layer 1 and then continue to Layer 2. During the playback of a recording spanning both layers, you may notice a brief stop (about 1 second) at the point where the camcorder switches to the second layer.

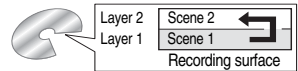

DVD-RW

Best for Reusability

Recordings made on a DVD-RW disc can be edited or deleted. Also, the disc can be initialized¹ allowing you to use the same disc numerous times.

Disc specification on DVD-RWs

DVD-RW discs can be recorded using either one of two disc specifications: VIDEO mode or VR mode. When you first insert a brand new DVD-RW disc, the camcorder will automatically display the initialization screen where you can select the disc specification for the disc.

VIDEO mode: Once finalized², discs recorded in VIDEO mode can be played back in most common DVD players offering the best compatibility. However, recordings cannot be edited (deleted, rearranged, etc.).

VR mode: You can easily edit the recordings. However, discs recorded in VR mode can only be played back with DVD players compatible with DVD-RWs in VR mode.

Note: DVD-R and DVD-R DL discs can only be recorded in VIDEO mode.

Great Advantages of DVDs

Why DVDs are better than tapes

No need to worry about recording over a tape.

When you use a DVD, the camcorder will automatically record on the empty space of the disc. So you don't have to worry about mistakenly recording over a precious memory.

Just select a scene from the index screen.

You don't need to bother running a tape forwards and backwards to find the scene you want to play back. Simply select a scene from the index screen and start the playback in a breeze.

Easy Playback on a DVD player

After you finalize the disc you recorded, all you have to do is just pop it into a DVD player and start the playback. If you record your disc in VIDEO mode, you will be able to play back your disc on most tabletop DVD players and DVD devices.

Recommended Discs

The camcorder's performance was tested with single-layered discs using Hitachi-Maxell HG series DVD discs; and with dual-layered discs using Canon DVD-R DL54 discs and Verbatim DVD-R DL discs. For further details, contact directly the manufacturer's customer support center. Note that attempting to record or play with this camcorder DVD discs that were recorded, initialized or finalized with other digital devices can result in permanently losing the recordings.

For the highest compatibility with external DVD devices we recommend using the VIDEO mode.

Available features depend on the DVD disc used

Disc Type	DVD-R	DVD-R DL	DVD-RW	
			VIDEO	VR
Editing scenes with this camcorder (deleting scenes, editing the Playlist) (□□51)	—	—	—	●
Deleting a scene or still image immediately after recording it (□□52, 56)	—	—	●	●
Initializing the disc in order to use it again for recording (□□54)	—	—	●	●
Giving a title to the disc (□□55)	●	●	●	●
Finalizing the disc in order to play it with a DVD player (□□58)	●	●	●	● ³
Adding recordings to a disc already finalized (□□60)	—	—	● ⁴	●
Converting still images into Photomovie scenes (□□57)	●	●	●	●

¹ Disc initialization clears all the recordings on the disc and restores the free space on the disc to its initial value so you can use the same disc again. DVD-R and DVD-R DL discs cannot be initialized.

² Disc finalization is the processing of the free space (the unrecorded area) on the disc in order to make it playable on external DVD devices (□□58). To finalize a DVD-R DL disc, the camcorder has to process both layers. Therefore, and depending on the amount of free space on the disc, this process may be lengthy.

³ Playback cannot be guaranteed with all external DVD devices.

⁴ You will need to unfinalize the disc first.

Table of contents

Introduction

How to select a DVD disc	3
--------------------------------	---

About this Manual

About the Joystick and the Joystick Guide	9
About the Power Switch	10
About the Operating Modes	10

Getting to Know the Camcorder

Supplied Accessories	11
Components Guide	12
Screen Displays	14

Preparations

Getting Started

Charging the Battery Pack	17
Inserting and Removing a Disc	19
Preparing the Camcorder	20
Adjusting the LCD Screen	21

Using the Menus

Selecting a FUNC. Menu Option	22
Selecting an Option from the Setup Menus	22

First Time Settings

Changing the Language	23
Changing the Time Zone	23
Setting the Date and Time	24

Basic Functions

Recording

Shooting Video	25
Selecting the Aspect Ratio of your Recordings (16:9 Widescreen or 4:3)	26
Taking Photos	27
Zooming	28
Quick Start Function	28

Playback

Playing Back the Video	29
Displaying the Photos	30
Magnifying Photos during Playback	32

Advanced Functions

Menu Options Lists

FUNC. Menu	33
Setup Menus	34
Camera Setup (Digital Zoom, Image Stabilizer, etc.)	34
Disc Operations (Photomovie, Finalize, etc.)	36
Still Image Operations (Erase all still images)	37
Display Setup (LCD Brightness, Language, etc.)	37
System Setup (Volume, Beep, etc.)	38
Date/Time Setup	39

Recording Programs

Using the Recording Programs	40
P Flexible Recording: Changing the Aperture and Shutter Speed	41
Special Scene: Recording Programs to Match Special Conditions	42

Adjusting the Picture: Exposure, Focus and Color

Manual Exposure Adjustment.....	43
Manual Focus Adjustment.....	43
White Balance	44
Image Effects.....	45

Still Image Recording Options

Selecting the Size and Quality of Still Images	46
Automatic Focus Priority.....	47

Other Functions

On-Screen Displays.....	48
Self Timer	49
Digital Effects.....	49

Editing Functions**Managing Scenes**

Adding Scenes to the Playlist	51
Moving Scenes in the Playlist.....	52
Deleting Scenes	52
Dividing a Scene.....	53

Managing the Disc

Protecting the Disc	54
Initializing the Disc.....	54
Changing the Disc Title	55

Managing Photos

Erasing Photos	56
Converting Photos into Photomovie Scenes	57

Playing Back the Disc on an External Device

Finalizing the Disc	58
Playing Back your Disc on a DVD Player or a Computer's DVD Drive	59
Unfinalizing the Disc - Additional Recordings on a Finalized Disc	60

External Connections**Connecting to a TV or VCR**

Connection Diagrams	61
Playback on a TV Screen	62
Recording to a VCR or Digital Video Recorder	62

Additional Information**Trouble?**

Troubleshooting	63
List of Messages.....	67

Do's and Don'ts

Handling Precautions	69
Maintenance/Others	71
Using the Camcorder Abroad.....	72



General Information

System Diagram	73
Optional Accessories	74
Specifications	76
Index	78

The functions assigned to the joystick change according to the operation mode and the camcorder's settings. Press () to display/hide the joystick guide.

In the illustrations of the manual, positions other than those relevant to the function explained are marked with a striped pattern. Depending on the mode and the operation mode, these positions may be empty or show a different icon than the one on the illustration.



When the joystick guide contains multiple 'pages', [NEXT] and the page number icon () will appear at the bottom position. Push the joystick () toward [NEXT] to display the next 'page' of the guide.

About the Power Switch



In addition to turning the camcorder on and off, the power switch also toggles the camcorder's operating mode.













To turn on the camcorder: Hold the lock button pressed down and move the power switch down and to ON.

To change the operating mode: From the ON position, slide down the power switch momentarily toward MODE and release it. This action will toggle the operating mode between recording (CAMERA - red indicator) and playback (PLAY - green indicator).





About the Operating Modes

The camcorder's operating mode is determined by the positions of the power switch and the  switch. In the manual,  indicates that a function is available in the operating mode shown and  indicates that the function is not available. When no operating mode icons are given, the function is available in all operating modes.

Operating Mode	Operating Mode Indicator	 Switch	Icon Display	Operation	
	CAMERA (Red)	 (Movies)		Recording movies on the disc	25
	PLAY (Green)			Playing movies from the disc	29
	CAMERA (Red)	 (Still images)		Recording still images on the disc	27
	PLAY (Green)			Viewing still images from the disc	30

Supplied Accessories

<p>CA-570 Compact Power Adapter (incl. power cord)</p> 	<p>BP-208 Battery Pack</p> 	<p>STV-250N Stereo Video Cable</p> 
----------------------------------------------------------------------------------------------------------------------------------------------	--------------------------------------------------------------------------------------------------------------	----------------------------------------------------------------------------------------------------------------------

Trademark Acknowledgements

-  is a trademark of DVD Format/Logo Licensing Corporation.
- Manufactured under license from Dolby Laboratories.
- "Dolby" and the double-D symbol are trademarks of Dolby Laboratories.
- Other names and products not mentioned above may be trademarks or registered trademarks of their respective companies.
- ANY USE OF THIS PRODUCT OTHER THAN CONSUMER PERSONAL USE IN ANY MANNER THAT COMPLIES WITH THE MPEG-2 STANDARD FOR ENCODING VIDEO INFORMATION FOR PACKAGED MEDIA IS EXPRESSLY PROHIBITED WITHOUT A LICENSE UNDER APPLICABLE PATENTS IN THE MPEG-2 PATENT PORTFOLIO, WHICH LICENSE IS AVAILABLE FROM MPEG LA, L.L.C., 250 STEELE STREET, SUITE 300, DENVER, COLORADO 80206.



Components Guide

Left side view

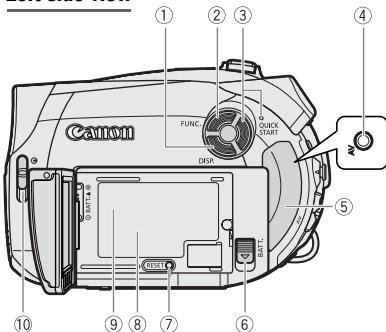

Right Side View

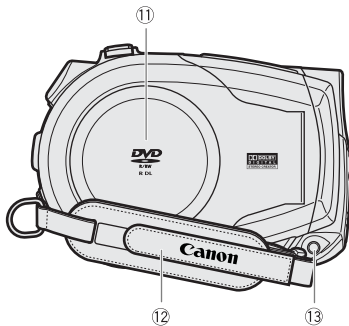

Front view

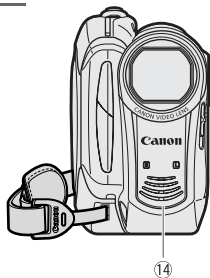

- ① DISP. button (48)
- ② FUNC. button (22, 33)
- ③ QUICK START button and standby lamp (28)
- ④ AV terminal (61)
- ⑤ Terminal cover
- ⑥ BATT. (battery release) switch (17)
- ⑦ RESET button (63)
- ⑧ Serial number
- ⑨ Battery attachment unit (17)
- ⑩ Lens cover switch (25, 27)
(☺ open, ☹ closed)
- ⑪ Disc compartment cover (19)
- ⑫ Grip belt (20)
- ⑬ DC IN terminal (17)
- ⑭ Stereo microphone

Names of buttons and switches other than the joystick are indicated within a “button” frame (for example **FUNC.**).

Back view

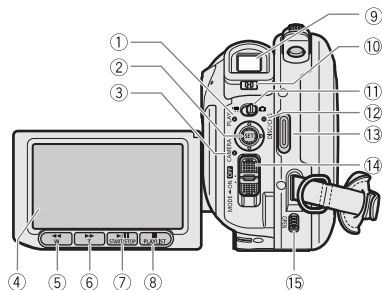

Top view

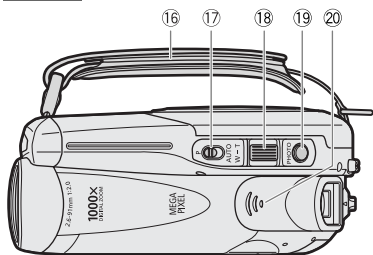

Bottom view

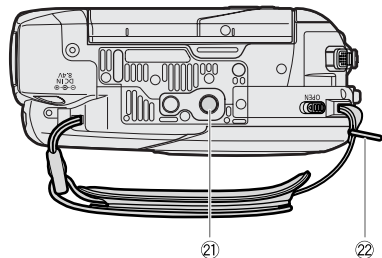









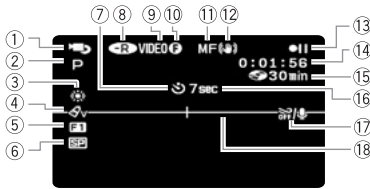



- ① PLAY mode indicator (green) (10)
- ② Joystick (9)
- ③ CAMERA mode indicator (red) (10)
- ④ LCD screen (21)
- ⑤ ◀◀ (fast reverse) button (30) /
Zoom out **W** (wide-angle) button (28)
- ⑥ ▶▶ (fast forward) button (30) /
Zoom in **T** (telephoto) button (28)
- ⑦ ▶/|| (play/pause) button (29) /
START/STOP button (25)
- ⑧ ■ (stop) button (29) /
PLAYLIST button (51)
- ⑨ Viewfinder (20)
- ⑩ Dioptic adjustment lever (20)
- ⑪ **M**/**STILL** (movies/still images) switch (10)
- ⑫ DISC access indicator (25, 27) /
CHG (charge) indicator (17)
- ⑬ Start/stop button (25)
- ⑭ Power switch (10)
- ⑮ OPEN (disc cover) switch (19)
- ⑯ Grip belt (20)
- ⑰ Mode switch (40)
- ⑱ Zoom lever (28)
- ⑲ PHOTO button (27)
- ⑳ Speaker (30)
- ㉑ Tripod socket (26)
- ㉒ Strap mount

Names of buttons and switches other than the joystick are indicated within a "button" frame (for example [FUNC.]).

Screen Displays









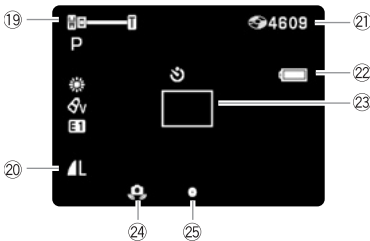



CAMERA - Recording Movies



- ① Operating mode ( 10)
- ② Recording program ( 40)
- ③ White balance ( 44)
- ④ Image effect ( 45)
- ⑤ Digital effects ( 49)
- ⑥ Recording mode ( 33)
- ⑦ Self timer ( 49)
- ⑧ Disc type  DVD-R,  DVD-R DL,  DVD-RW ( 3)
- ⑨ Disc specification (VIDEO mode, VR mode) ( 3)

CAMERA - Recording Still Images



- ⑩ Finalized disc mark ( 58)
- ⑪ Manual focus ( 43)
- ⑫ Image stabilizer ( 35)
- ⑬ Disc operation
- ⑭ Time code (hours : minutes : seconds)
- ⑮ Remaining recording time on the disc
- ⑯ Recording reminder
- ⑰ Wind screen off ( 36)
- ⑱ Level marker ( 37)
- ⑲ Zoom ( 28), Exposure   ( 43)
- ⑳ Still image quality/size ( 46)
- ㉑ Number of still images available on the disc
- ㉒ Remaining battery charge estimate
- ㉓ AF frame ( 47)
- ㉔ Camcorder shake warning ( 34)
- ㉕ Autofocus (AF) and exposure (AE) locked ( 27)

13 Disc operation

- Record, ●|| Record pause,
- ▶ Playback, ||| Playback pause,
- ▶▶ Fast playback,
- ◀◀ Fast reverse playback,
- ▶ Slow playback,
- ◀ Slow reverse playback

15 Remaining recording time

When there is no more disc space available, “END” will be displayed and the recording will stop.

16 Recording reminder

The camcorder counts from 1 to 10 seconds when you start recording. This is helpful to avoid scenes that are too short.

21 Number of still images available on the disc

- flashing in red: No disc
- in green: 6 or more images
- in yellow: 1 to 5 images
- in red: No more images can be recorded

- When viewing the still images, the display will always be in green.
- Depending on the recording conditions, the number of available still images displayed may not decrease even after a recording has been made, or may decrease by 2 still images at once.

Disc access display

“▶” is displayed next to the number of images available while the camcorder is writing on the disc.

22 Remaining battery charge estimate



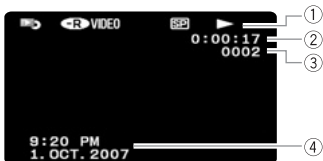

- When “” starts flashing in red replace the battery pack with a fully charged one.
- When you attach an empty battery pack, the power may turn off without displaying “”.
- Depending on the conditions under which the camcorder and the battery pack are used, the actual battery charge may not be indicated accurately.



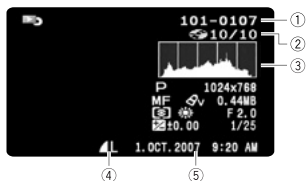

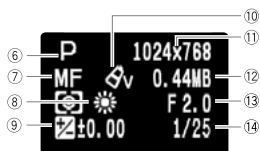

PLAY  Playing Movies (During Playback)

- ① Disc operation
- ② Playback time (hours : minutes : seconds)
- ③ Scene number
- ④ Data code ( 48)

PLAY  Viewing Still Images

- ① Image number ( 38)
- ② Current image / Total number of images
- ③ Histogram ( 48)
- ④ Still image quality/size ( 46)
- ⑤ Date and time of recording



- ⑥ Recording program ( 40)
- ⑦ Manual focus ( 43)
- ⑧ White balance ( 44)
- ⑨ Manual exposure ( 43)
- ⑩ Image effect ( 45)
- ⑪ Image size ( 46)
- ⑫ File size
- ⑬ Aperture value
- ⑭ Shutter speed ( 41)

Getting Started

Charging the Battery Pack

The camcorder can be powered with a battery pack or directly using the compact power adapter. Charge the battery pack before use.

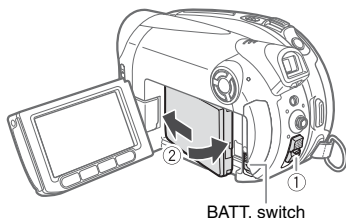

- 1 Turn off the camcorder.
- 2 Attach the battery pack to the camcorder.
 - Open the LCD panel.
 - Slide in the connector end of the battery in the direction of the arrow and press it gently until it clicks.

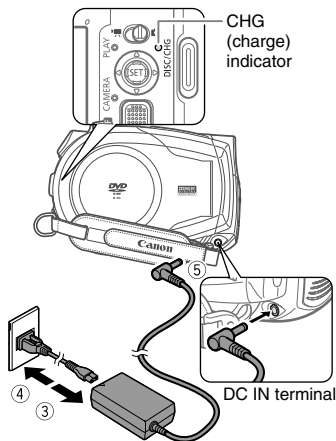

- 3 Connect the power cord to the compact power adapter.

- 4 Plug the power cord into a power outlet.
- 5 Connect the compact power adapter to the camcorder's DC IN terminal.
 - The CHG (charge) indicator starts flashing. The indicator will stay on when the charging is completed.
 - You can also use the compact power adapter without attaching a battery pack.
 - When the compact power adapter is connected, even if a battery is attached its power will not be consumed.

ONCE THE BATTERY IS FULLY CHARGED

- 1 Disconnect the compact power adapter from the camcorder.
- 2 Unplug the power cord from the power outlet and the compact power adapter.

TO REMOVE THE BATTERY PACK

Slide down **BATT.** to release the battery pack, and pull out the battery pack holding it from the ridge on its bottom part.

! IMPORTANT

- Turn off the camcorder before connecting or disconnecting the compact power adapter. After you turn off the power switch to **OFF**, important file allocation data is updated on the disc. Be sure to wait until the LCD display is completely off.
- You may hear some noise from the compact power adapter during use. This is not a malfunction.
- We recommend charging the battery pack in temperatures between 10 °C and 30 °C. Outside the temperature range of 0 °C to 40 °C, the charging will not start.
- Do not connect to the camcorder's DC IN terminal or to the compact power adapter any electrical equipment that is not expressly recommended for use with this camcorder.
- To prevent equipment breakdowns and excessive heating, do not connect the supplied

compact power adapter to voltage converters for overseas travels or special power sources such as those on aircraft and ships, DC-AC inverters, etc.

i NOTES

- The CHG (charge) indicator also serves as a rough estimate of the battery charge status. Continuously on: Battery fully charged.

Flashes approx. twice per second: Battery over 50% charged.

Flashes approx. once per second: Battery less than 50% charged.

- The charging time will vary depending on the surrounding temperature and the battery pack's initial charge condition. In cold places, the effective usage time of the battery will decrease.

- We recommend that you prepare battery packs 2 to 3 times longer than you think you might need.



Charging, Recording and Playback Times with the BP-208 Battery Pack

The recording and playback times given in following tables are approximate and vary according to the charging, recording or playback conditions.

Battery Pack	BP-208					
	XP		SP		LP	
Recording Mode	Maximum	Typical*	Maximum	Typical*	Maximum	Typical*
Viewfinder	115 min.	60 min.	135 min.	65 min.	145 min.	70 min.
LCD [NORMAL]	110 min.	60 min.	125 min.	65 min.	140 min.	65 min.
LCD [BRIGHT]	105 min.	60 min.	120 min.	60 min.	130 min.	65 min.
Playback Time	140 min.		165 min.		175 min.	
Charging Time	160 min.					

* Approximate times for recording with repeated operations such as start/stop, zooming, power on/off.

Inserting and Removing a Disc

Use only 8 cm mini DVD discs marked with the DVD-R  logo (including DVD-R DL) or the DVD-RW  logo. Refer also to *Recommended Discs* (📖 4). Before inserting the disc be sure to check that the recording surface is clean. If necessary, use a soft lens-cleaning cloth to remove any fingerprints, dirt buildup or smudges from the disc surface.

Inserting the Disc



POINTS TO CHECK



(📖 10)

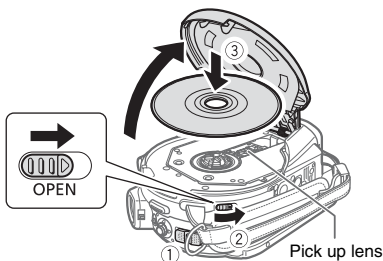

1 Move the power switch to ON to set the camcorder in **CAMERA** mode.

2 Slide **OPEN** fully in the direction of the arrow and gently open the disc cover completely until it stops.

Retract the grip belt under the camcorder so it will not get in the way of the disc cover.

3 Insert the disc and press its center firmly until it clicks in place.

- Insert the disc with the recording side facing down (single sided discs – label side facing out).
- Be careful not to touch the recording surface of the disc or the pick up lens.

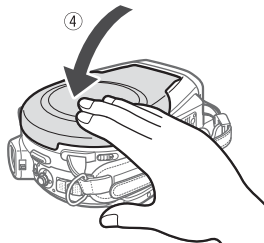



4 Close the disc cover.







Do not force the cover closed if the disc is not correctly inserted and firmly set in place.

WHEN USING DVD-R/DVD-R DL DISCS

You can start recording movies once the record pause  indication appears.

WHEN USING A DVD-RW

You need to initialize new discs before you can start recording. The disc initialization screen will appear when a new DVD-RW is first inserted if the  switch is set to . The disc initialization screen will not appear when inserting a disc already initialized. In that case, you can start recording once the record pause  indication appears.

- ① Select () the desired disc specification and press (). For a comparison between the [VIDEO] and [VR] specifications, see *How to select a DVD disc* (📖 3).
- ② You will be asked to confirm the disc specification you selected. Select () [YES] and press () to continue, or select [NO] and press () to return and select a different disc specification.
- ③ A confirmation message will appear on the screen. Select () [YES] and press () to start the disc initialization.

- The disc initialization will take approximately one minute. Avoid moving the camcorder while the operation is in progress.
- You can start recording movies once the record pause ●|| indication appears.

i NOTES

The process of recognizing a disc may take a moment. The  display will move while the disc is being read. Wait until the camcorder finishes recognizing the disc before you start recording.

Removing the Disc

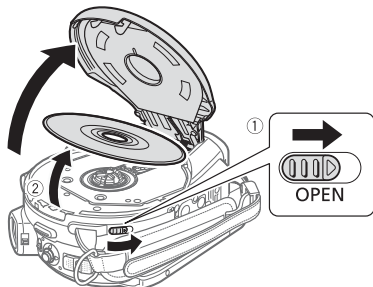

- 1 Slide **OPEN** fully in the direction of the arrow and gently open the disc cover completely until it stops.**

- Do not subject the camcorder to strong impacts while the DISC access indicator is on or flashing.
- Retract the grip belt under the camcorder so it will not get in the way of the disc cover.
- It may take a moment after sliding **OPEN** for the disc cover to open.

- 2 Grab the edge of the disc and gently pull it out.**

Be careful not to touch the recording surface of the disc or the pick up lens.

- 3 Close the disc cover.**

! IMPORTANT

When you slide **OPEN** after making a recording, important file allocation data is updated on the disc before the disc cover opens. While the DISC access indicator is on or flashing do not subject the camcorder to shocks such as forcefully laying it on a table.

Preparing the Camcorder

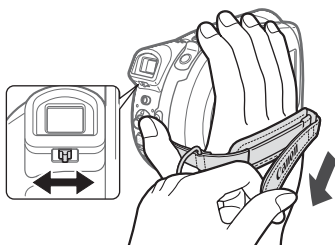

- 1 Turn on the camcorder.**
- 2 Move the lens cover switch down to  to open the lens cover.**

- 3 Adjust the viewfinder.**

Keep the LCD panel closed to use the viewfinder and adjust the dioptic adjustment lever as necessary.

- 4 Fasten the grip belt.**

Adjust the grip belt so that you can reach the zoom lever with your index finger, and the start/stop button with your thumb.

Adjusting the LCD Screen

Rotating the LCD Panel

Open the LCD panel 90 degrees.

- You can rotate the panel 90 degrees downward.
- You can rotate the panel 180 degrees toward the lens (allowing the subject to monitor the LCD screen while you use the viewfinder). Rotating the panel 180 degrees is also useful if you wish to include yourself when recording with the self timer. This is the only case where you can use the viewfinder and the LCD screen simultaneously.

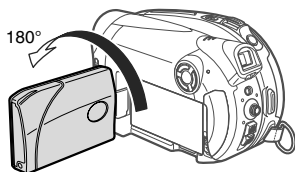
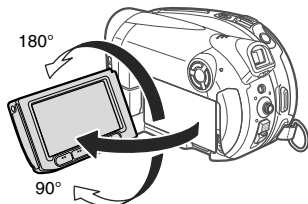

Subject can monitor the LCD screen

LCD Backlight

You can adjust the brightness of the LCD screen to one of two levels.

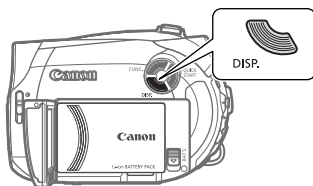

Keep **DISP.** pressed down for more than 2 seconds.

Repeat this action to toggle between the normal and bright settings.

i NOTES

- This setting does not affect the brightness of the recording or the viewfinder screen.
- Using the bright setting will shorten the effective usage time of the battery.

Using the Menus

Many of the camcorder's functions can be adjusted from the menus that open after pressing the FUNC. button (FUNC.).

For details about the available menu options and settings, refer to the *Menu Options Lists* (□ 33).

Selecting a FUNC. Menu Option



- 1 Press **FUNC.**.
- 2 Select (▲▼) the icon of the function you want change from the left side column. Menu items not available will appear grayed out.
- 3 Select (◀▶) the desired setting from the available options at the bottom bar.
 - The selected option will be highlighted in light blue. Menu items not available will appear grayed out.
 - With some settings, you will need to make further selections (▲▼, ▶◀) and/or press (SET). Follow the additional operation guides that will appear on the screen (such as the SET icon, small arrows, etc.).
- 4 Press **FUNC.** to save the settings and close the menu.

You can press **FUNC.** to close the menu at any time.

Selecting an Option from the Setup Menus



- 1 Press **FUNC.**.

During the playback of a disc recorded in VIDEO mode, pressing **FUNC.** will open directly the setup menu. Continue directly from step 3.
- 2 Select (▲▼) the  icon and press (SET) to open the setup menus.
 - You can also hold **FUNC.** pressed down for more than 1 second to open directly the setup menu screen.
 - Push the joystick (◀) to return to the menu selection screen (step 3).
- 3 Select (▲▼) the desired menu from the left side column and press (SET).

The title of the selected menu appears on top of the screen and under it the list of settings.
- 4 Select (▲▼) the setting you want to change and press (SET).

The orange selection bar indicates the menu setting currently selected. Items not available appear in black.
- 5 Select (▲▼) the desired option and press (SET) to save the setting.
- 6 Press **FUNC.**.

You can press **FUNC.** to close the menu at any time.

First Time Settings

Changing the Language

Options

[DEUTSCH]	[ROMÂNĂ]	[ภาษาไทย]
[ENGLISH]*	[TÜRKÇE]	[简体中文]
[ESPAÑOL]	[РУССКИЙ]	[繁體中文]
[FRANÇAIS]	[УКРАЇНСЬКА]	[한국어]
[ITALIANO]	[العربية]	[日本語]
[POLSKI]	[فارسی]	

* Default value

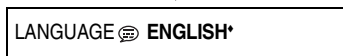
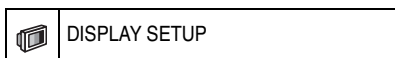

- 1 Press **[FUNC.]**.
- 2 Select (**▲▼**) the icon and press (**SET**) to open the setup menus.
- 3 Select (**▲▼**) [**DISPLAY SETUP**] and press (**SET**).
- 4 Select (**▲▼**) [**LANGUAGE**] and press (**SET**).
- 5 Select (**▼▲**, **◀▶**) the desired option and press (**SET**).
- 6 Press **[FUNC.]** to close the menu.

NOTES

- If you changed the language by mistake, follow the mark next to the menu item to change the setting.
- The displays **SET** and **FUNC.** that appear in some menu screens refer to the name of buttons on the camcorder and will not change, regardless of the language selected.

Changing the Time Zone

* Default value



- 1 Press **[FUNC.]**.
- 2 Select (**▲▼**) the icon and press (**SET**) to open the setup menus.
- 3 Select (**▲▼**) [**DATE/TIME SETUP**] and press (**SET**).
- 4 Select (**▲▼**) [**T.ZONE/DST**] and press (**SET**).
The time zone setting appears. The default setting is Paris.
- 5 Select (**▲▼**) your time zone and press (**SET**).
To adjust for daylight saving time, select the time zone with the mark next to the area.
- 6 Press **[FUNC.]** to close the menu.

Time Zones

Once you have set the time zone, date and time, you do not need to reset the clock every time you travel to another time zone. Select the time zone referring to the date and time displayed on the screen.

Setting the Date and Time

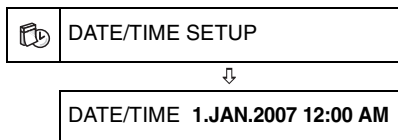

FUNC.
(22)

FUNC.



- 1 Press **FUNC.**.
- 2 Select (**▼▲**) the  icon and press (**SET**) to open the setup menus.
- 3 Select (**▼▲**) **[DATE/TIME SETUP]** and press (**SET**).
- 4 Select (**▼▲**) **[DATE/TIME]** and press (**SET**).
The first field of the date will be displayed in orange and indicated with up/down arrows.
- 5 Push the joystick (**▼▲**) to set the date and time and (**◀▶**) to move between the fields of the date and time.
- 6 Press (**SET**) to start the clock.
- 7 Press **FUNC.** to close the menu.

IMPORTANT

- When you do not use the camcorder for about 3 months, the built-in rechargeable lithium battery may discharge completely and the date and time setting may be lost. In such case, recharge the built-in lithium battery (70) and set the time zone, date and time again.
- You can also change the date format (39).

Recording

Shooting Video

Before You Begin Recording

Make a test recording first to check if the camcorder operates correctly. Since recordings made on a DVD-R or DVD-R DL disc cannot be deleted, we recommend you use a DVD-RW disc to make the test recordings.

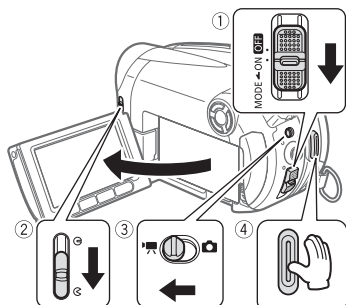

1 Move the power switch to ON to set the camcorder in CAMERA mode.

The red CAMERA indicator will turn on.

2 Move the lens cover switch down to open the lens cover.

3 Move the 'CAM/PLAY' switch to the 'CAM' (Movies) position.

4 Press **[Start/Stop]** to begin recording.

- The recording starts; press **[Start/Stop]** again to pause the recording.
- The DISC access indicator will flash while recording and will stay on briefly after pausing while the scene is recorded on the disc.

WHEN YOU HAVE FINISHED RECORDING

- 1 Make sure that the DISC access lamp is off.
- 2 Turn off the camcorder.
- 3 Close the lens cover and the LCD panel.
- 4 Remove the disc.

! IMPORTANT

Avoid the following actions while the DISC access indicator is on or flashing. Failing to do so may result in permanent data loss.

- Do not subject the camcorder to vibrations or strong impacts.
- Do not open the disc cover and do not remove the disc.
- Do not disconnect the power source or turn off the camcorder.
- Do not change the operating mode.

i NOTES

- **About the recording time:** By changing the recording mode you can change the recording time available on the disc (□ 33).
- When recording in bright places it may be difficult to use the LCD screen. In such case, use the viewfinder instead.
- When recording in very loud places (such as fireworks shows or concerts), sound may become distorted or it may not be recorded at the actual levels. This is not a malfunction.
- **About the Power Save mode:** To save power when the camcorder is powered by a battery pack, the camcorder will automatically shut off if left without any operations for 5 minutes (□ 38). To restore the power, slide the power switch toward MODE and release it, or move the power switch to OFF and back to ON again.
- **About the LCD and viewfinder screen:** The screens are produced using extremely high-precision manufacturing techniques, with more than 99.99% of the pixels operating to specification. Less than 0.01% of the pixels may occasionally misfire or appear as black, red, blue or green dots. This has no effect on the recorded image and does not constitute a malfunction.

● **When using a tripod:** Do not leave the viewfinder exposed to direct sunlight as it may melt (due to concentration of the light by the lens). Do not use tripods with fastening screws longer than 5.5 mm. Doing so may damage the camcorder.

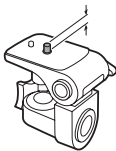

● **When recording movies, try to get a calm, stable picture.**

Excessive camcorder movement while shooting and extensive use of fast zooms and panning can result in fidgety, jittery scenes. In extreme cases, the playback of such scenes may result in visually induced motion sickness. If you experience such a reaction, immediately stop the playback and take a rest break as necessary.

Reviewing the Last Scene Recorded



- 1 If the joystick guide does not appear on screen, press (SET) to display it.
- 2 Push the joystick (◀) toward [G].
 - If [G] does not appear on the joystick guide, repeatedly push the joystick (▼) toward [NEXT] to display the joystick guide in the illustration above. When the mode switch is set to **AUTO**, only one joystick guide will appear.
 - The camcorder plays back the last scene (but without sound) and returns to record pause mode.
 - While reviewing the scene, select (◀▶) the ↺ icon and press (SET) to return to the recording mode.
 - If you are using a DVD-RW disc, you can also delete the scene immediately after recording it. Select (◀▶) the ↻ icon to delete the scene while reviewing it (□ 52).

Selecting the Aspect Ratio of your Recordings (16:9 Widescreen or 4:3)

You can select the aspect ratio of your recording to match your TV. The camcorder uses the full width of the CCD providing high-resolution 16:9 recording.

POINTS TO CHECK



• Default value

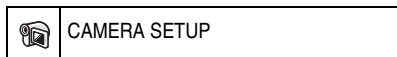

WIDESCREEN ON OFF

- 1 Press [FUNC.]
- 2 Select (▲▼) the [CAMERA] icon and press (SET) to open the setup menus.
- 3 Select (▲▼) [CAMERA SETUP] and press (SET).
- 4 Select (▲▼) [WIDESCREEN] and press (SET).
- 5 Select (▲▼) a setting option and press (SET).
The default is widescreen (16:9) recordings. Set it to [OFF OFF] to record movies in the normal (4:3) aspect ratio.
- 6 Press [FUNC.] to close the menu.

NOTES

- Since the displays on the camcorder have an aspect ratio of 16:9, recordings with a 4:3 aspect ratio will appear in the center of the screen with black sidebars.
- When recording in widescreen mode, with [IMG STAB] set to [OFF OFF] (□ 35), you can have a wider view angle.
- **Playing back a widescreen recording:** TV sets compatible with the WSS system will automatically switch to wide (16:9) mode. Otherwise, change the aspect ratio of the TV

manually. To play back on a TV with normal aspect ratio (4:3) change the [TV TYPE] setting accordingly (38).

Taking Photos

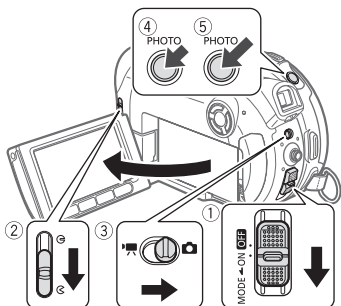

1 Move the power switch to ON to set the camcorder in CAMERA mode.

The red CAMERA indicator will turn on.

2 Move the lens cover switch down to ☺ to open the lens cover.

3 Move the /📷 switch to the 📷 (Still images) position.

4 Press **PHOTO halfway.**

Once the focus is automatically adjusted, ● will turn green and one or more AF frames will appear.

5 Press **PHOTO fully.**

The DISC access indicator will flash as the still image is being recorded.

! IMPORTANT

Avoid the following actions while the disc access display (▶📀) appears on screen, and when the DISC access indicator is on or flashing. Failing to do so may result in permanent data loss.

- Do not subject the camcorder to vibrations or strong impacts.
- Do not open the disc cover and do not remove the disc.
- Do not disconnect the power source or turn off the camcorder.
- Do not change the position of the /📷 switch or the operating mode.

i NOTES

If the subject is not suitable for autofocus, ● turns yellow. Adjust the focus manually (43).

Zooming

POINTS TO CHECK



CAMERA : In addition to the optical zoom, the digital zoom is also available (35).

	DC210/DC211	DC201
Optical zoom	35x	30x
Digital zoom*	1,000x	800x

* **CAMERA** only.

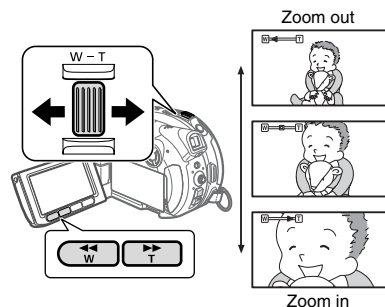

Optical Zoom

(DC210/DC211) 35x, (DC201) 30x)

Move the zoom lever toward **W** to zoom out (wide-angle). Move it toward **T** to zoom in (telephoto).

You can also change the zoom speed (35). You can select one of three fixed zoom speeds or a variable speed that depends on how you operate the zoom lever: Press gently for a slow zoom; press harder for faster zooms.

NOTES

- When set to [VAR VARIABLE], the zoom speed will be faster in the record pause mode.
- Keep at least 1 m to the subject. At wide-angle, you can focus on a subject as close as 1 cm.

Quick Start Function

Using the Quick Start function, you'll never have to miss out on those great and fleeting opportunities to take a picture or record video. When you press **QUICK START** instead of turning off the camcorder, you can get it ready to start recording within approx. 1 second.

POINTS TO CHECK



CAMERA : You cannot enter the Quick-Start ready mode while recording.

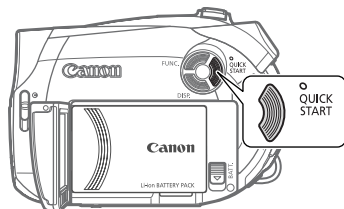

1 Press **QUICK START** firmly.

- The standby lamp goes on to signal that the camcorder is Quick-Start ready - "ready and waiting" to resume recording.
- Sometimes the standby lamp will flash as the camcorder completes some preparations. The camcorder is Quick-Start ready when the lamp stops flashing and stays on.

2 When you wish to resume recording, press **QUICK START** again.

Within approx. 1 second, the camcorder is ready in record pause mode.

i NOTES

- When you wake up the camcorder from standby mode, the following settings will be changed automatically:
 - Manual focus returns to automatic focus (AF).
 - Manual exposure adjustment returns to automatic exposure.
 - Zoom position returns to full wide angle **W**.
- In standby mode, the camcorder consumes only half the power used in record pause mode. Using this mode you can save energy when using a battery pack.
- The camcorder will shut off if left in the Quick-Start ready mode for 10 minutes, regardless of the [POWER SAVE] setting (□ 38). You can select the length of time until shut-off with the [STANDBY OFF] setting (□ 38). To restore the power if the camcorder shut off, slide the power switch toward MODE and release it, or move the power switch to **OFF** and back to ON again.
- If you perform any of the following actions while in standby mode (while the standby lamp is on), the camcorder will return to record pause mode.
 - Open the disc compartment cover.
 - Slide the power switch toward MODE.
 - Change the position of the **MOVIES/VIDEO** switch.

Playback

Playing Back the Video

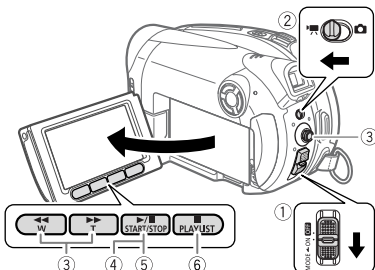

- 1 Move the power switch to ON, then slide it down toward MODE and release it to set the camcorder in PLAY mode.**
The green PLAY indicator will turn on.
- 2 Move the **MOVIES/VIDEO** switch to the **MOVIES** position.**
The scene index screen appears with the selection frame on the first scene.
- 3 Move (**▲▼**, **◀▶**) the selection frame to the scene you want to play back.**
Press **▶▶** or **◀◀** on the camcorder to move to the next/previous index page.
- 4 Press **▶||** to begin the playback.**
The playback will start from the scene selected and continue until the end of the last scene recorded.

DURING PLAYBACK

- 5 Press **▶||** again to pause the playback.**
- 6 Press **■** to stop the playback and return to the scene index screen.**

i NOTES

- During the playback of a DVD-R DL (dual-layered) disc, you might notice a brief stop

(approx. 1 second) at the point where the playback switches from Layer 1 to Layer 2.

● You can display the date and time of the recording and other camcorder data registered when the recording was made (48).

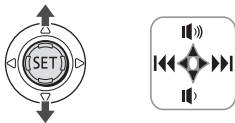

TO ADJUST THE VOLUME

The camcorder plays the sound with the built-in speaker. The sound will be muted when you close the LCD panel or connect the stereo video cable to the AV terminal. During the playback of a scene:

1 If the joystick guide does not appear on screen, press (SET) to display it.

2 Push the joystick (▲▼) toward (||) or (||) to adjust the volume.

- To turn off the volume completely, keep pressing (▼) until the volume icon changes to (OFF).

- You can press (SET) again to hide the joystick guide during playback.

SPECIAL PLAYBACK MODES

● Fast Playback

During normal playback, press (▶) or (◀) on the camcorder. Repeatedly press the button to increase the playback speed.

Fast playback: 5x → 15x → 25x
the normal speed.

● Slow Playback

During playback pause, press (▶) or (◀) on the camcorder. Repeatedly press the button to increase the playback speed.

Slow playback: 1/16 → 1/8 → 1/4
the normal speed.

● Skipping Scenes

During playback, push the joystick (▶) to skip to the next scene. Push the joystick (◀) to skip to the beginning of the current scene. Push the joystick (◀) twice to skip to the previous scene.

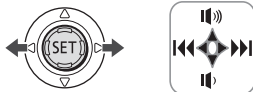

Note that you do not have to display the joystick guide above to skip the scene.

i NOTES

- There is no sound during special playback modes.
- During some special playback modes, you may notice some video problems (blocky video artifacts, banding, etc.) in the playback picture.
- Slow playback is not available with discs initialized in VIDEO mode.
- Depending on the recording, you might occasionally notice a brief stop of the picture or sound at the point where the scene changes.

Displaying the Photos

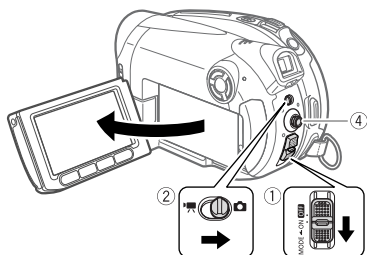

1 Move the power switch to ON, then slide it down toward MODE and release it to set the camcorder in PLAY mode.

The green PLAY indicator will turn on.

2 Move the (CAMERA) switch to the (CAMERA) (Still images) position.

3 Use the joystick (◀) to move between images.

! IMPORTANT

- The following may not be displayed correctly.
 - Images not recorded with this camcorder.
 - Images edited on or uploaded from a computer.
 - Images whose file names have been changed.
- Avoid the following actions while the disc access display (▶) appears on screen, and when the DISC access indicator is on or flashing. Failing to do so may result in permanent data loss.
 - Do not subject the camcorder to vibrations or strong impacts.
 - Do not open the disc cover and do not remove the disc.
 - Do not disconnect the power source or turn off the camcorder.
 - Do not change the position of the switch or the operating mode.

Slideshow

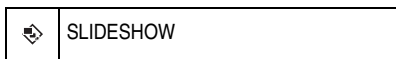

FUNC.
(22)



- 1 Press **[FUNC.]**.
- 2 Select (**▲▼**) [**SLIDESHOW**] and press (**SET**).
- 3 Select (**◀▶**) [**START**] and press (**SET**).
 - Images are played back one after another.
 - Press **[FUNC.]** to stop the slideshow.

Index Screen

- 1 **Move the zoom lever toward W.**
The still images index screen appears.
- 2 **Select (▲▼, ◀▶) an image.**
 - Move the green selection frame to the image you want to view.
 - If you have a lot of still images, you may find it easier to browse entire index pages instead. Move the zoom

lever toward **W** to extend the green selection frame to the whole page, and move (**◀▶**) between index pages. Move the zoom lever toward **T** to return to moving between single images.

3 Move the zoom lever toward T.

The index screen closes and the selected image is displayed.

Image Jump Function

You can also quickly locate a specific image without having to browse all of them one by one.

To RUN THROUGH THE STILL IMAGES



Push the joystick (**◀**) or (**▶**) and hold it pressed down to run quickly through the still images.

To SKIP 10 OR 100 STILL IMAGES

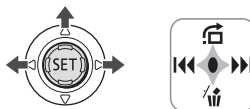

- 1 If the joystick guide does not appear on screen, press (**SET**) to display it.
- 2 Push the joystick (**▲**) toward .
- 3 Select (**▲▼**) [**JUMP 10 IMAGES**] or [**JUMP 100 IMAGES**].
- 4 Jump (**◀▶**) the number of images selected.
Press (**SET**) to close the image jump screen and display the image. You can press (**SET**) again to hide the joystick guide.

Magnifying Photos during Playback

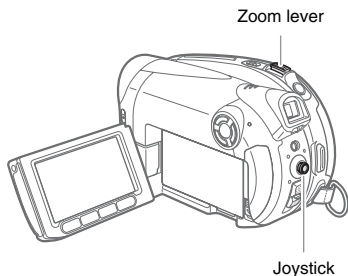

During playback, still images can be magnified up to 5 times.



1 Move the zoom lever toward **T**.

- The image is magnified by 2 times and a frame appears indicating the position of the magnified area.
- To further enlarge the image, move the zoom lever toward **T**. To reduce the magnification to less than 2 times, move the zoom lever toward **W**.
-  will appear for images that cannot be enlarged.

2 Select the part of the image to be magnified with the joystick.

- Move (, ) the frame to the part of the image you want to see enlarged.
- To cancel the magnification, move the zoom lever toward **W** until the frame disappears.

Menu Options Lists

Menu items not available appear grayed out in the FUNC. menu or in black in the setup menus. For details about how to select an item, refer to *Using the Menus* (□ 22).

FUNC. Menu

Recording programs

(□ 40)



Mode switch: P

[**P**] PROGRAM AE],

[**TV**] SHUTTER-PRIO. AE],

Special scene recording programs:

[**PO**] PORTRAIT], [**SP**] SPORTS],

[**N**] NIGHT], [**SN**] SNOW], [**BE**] BEACH],

[**S**] SUNSET], [**SP**] SPOTLIGHT],

[**FW**] FIREWORKS]

White balance

(□ 44)



Mode switch: P

[**AWB**] AUTO], [**DL**] DAYLIGHT],

[**T**] TUNGSTEN], [**SET**]

Image effect

(□ 45)



Mode switch: P

[**OFF**] IMAGE EFFECT OFF],

[**V**] VIVID], [**N**] NEUTRAL],

[**SD**] SOFT SKIN DETAIL]

Digital effects

(□ 49)



Mode switch: P

[**OFF**] D.EFFECT OFF], [**F**] FADE-T],

[**W**] WIPE], [**B**] BLK&WHT],

[**S**] SEPIA], [**A**] ART], [**M**] MOSAIC]



Mode switch: P

[**OFF**] D.EFFECT OFF], [**B**] BLK&WHT],

[**S**] SEPIA]

Recording mode



[**XP**] HIGH QUALITY],

[**SP**] STANDARD PLAY], [**LP**] LONG PLAY]

The table below gives the approximate recording times with a brand new DVD disc (on a single recording side).

Recording Mode	Disc Type	
	DVD-R, DVD-RW	DVD-R DL
XP	20 min.	36 min.
SP	30 min.	54 min.
LP	60 min.	108 min.

● Recording in LP mode gives you a longer recording time; however, depending on the condition of the disc (long usage, imperfections, etc.) the picture and sound recorded in LP mode may be distorted. We recommend using the XP or SP mode for important recordings.

● The camcorder uses a variable bit rate (VBR) when encoding the video data so the actual recording times will vary depending on the content of the scenes.

Still image size/quality (F5 46)

Size:

[L 1024x768], [S 640x480]

Quality:

[SUPER FINE], [FINE], [NORMAL]

ADD TO PLAYLIST (F5 51)

Disc type: (RW) • VR mode
 [ALL SCENES], [ONE SCENE],
 [CANCEL]

Add a scene to the playlist. This option is available only from the original index screen.

MOVE (F5 52)

Disc type: (RW) • VR mode
 Move a scene in the playlist. This option is available only from the playlist index screen.

DIVIDE (F5 53)

Disc type: (RW) • VR mode
 Divide a scene.

DELETE (F5 52)

Disc type: (RW) • VR mode
 Delete a scene.

CONVERT TO SCENE (F5 57)

Convert a single still image into a 3-second Photomovie scene.

SLIDESHOW (F5 31)

[CANCEL], [START]

Setup Menus**CAMERA SETUP****A.S.L SHUTTER**

Mode switch: **AUTO** or **P** (only in the [PROGRAM AE] recording program)
 [ON ON], [OFF OFF]

The camcorder automatically uses slow shutter speeds to obtain brighter recordings in places with insufficient lighting.

- The camcorder uses shutter speeds down to 1/25 (1/12 when recording still images).
- If a trailing afterimage appears, set the slow shutter to [OFF OFF].
- If (camcorder shake warning) appears, we recommend stabilizing the camcorder, for example, by mounting it on a tripod.

D.ZOOM



DC210/DC211

[OFF OFF], [105x 105x], [1000x 1000x]

DC201

[OFF OFF], [90x 90x], [800x 800x]

Determines the operation of the digital zoom.

- When activated, the camcorder will switch automatically to the digital zoom when you zoom in beyond the optical zoom range.
- With the digital zoom the image is digitally processed, so the image resolution will deteriorate the more you zoom in.
- About the color of the zoom indicator:

Zoom Indicator	Optical Zoom	Digital Zoom	
		Light blue	Dark blue
DC210/DC211	35x	35x - 105x	105x - 1000x
DC201	30x	30x - 90x	90x - 800x

- The digital zoom cannot be used with the [NIGHT] recording program.

ZOOM SPEED



[VAR VARIABLE], [>>> SPEED 3],

[>> SPEED 2], [> SPEED 1]

- When set to [VAR VARIABLE] the zoom speed depends on how you operate the zoom lever: Press lightly for a slow zoom; press harder for faster zooms.
- The fastest zoom speed can be achieved with [VAR VARIABLE]. Among the fixed zoom speeds, [>>> SPEED 3] is the fastest and [> SPEED 1] the slowest.

IMG STAB



Mode switch: P

[ON ON (👁️)], [OFF OFF]

The image stabilizer compensates for camcorder shake even at full telephoto.

- The image stabilizer is designed to compensate for a normal degree of camcorder shake.
- The image stabilizer may not be effective when recording in dark places using the [NIGHT] recording program.
- The image stabilizer may not be effective when using a slow shutter speed with the [TV SHUTTER-PRIO. AE] recording program.
- The image stabilizer cannot be turned off when the mode switch is set to **AUTO**.
- We recommend setting the image stabilizer to [OFF OFF] when using a tripod.

FOCUS PRI.

(📖 47)



Mode switch: P

[AiAF ON: AiAF], [[] ON: CENTER],

[OFF OFF]

WIDESCREEN

(📖 26)



[ON ON], [OFF OFF]

SELF TIMER

(📖 49)



[ON ON (🕒)], [OFF OFF]

WIND SCREEN

Mode switch: **P**

[**A**] **AUTO**], [**OFF**] **OFF**

The camcorder automatically reduces the background sound of wind when recording outdoors.

- The wind screen cannot be turned off when the mode switch is set to **AUTO**.
- Some low-frequency sounds will be suppressed along with the sound of wind. When recording in surroundings unaffected by wind or if you want to record low-frequency sounds, we recommend setting the wind screen to [**OFF**] **OFF** .

DISC OPERATIONS

DISC INFO

Displays a screen where you can verify the details regarding the disc.

- The disc information includes the disc title, the disc type (DVD-R, DVD-R DL or DVD-RW), the disc specification (VIDEO mode or VR mode), and icons that indicate if the disc is finalized () or protected (.

DISC INITIALIZE

(60)



Disc type: **VR**

[**VIDEO**], [**VR**], [**CANCEL**]

FINALIZE

(58)



[**NO**], [**YES**]

UNFINALIZE

(60)



Disc type: **VIDEO** mode • Finalized
[**NO**], [**YES**]

MOVIES ALL DEL

(53)



Disc type: **VR** mode
[**NO**], [**YES**]

This option is available only in the original index screen.

PLAYLIST ALL DEL

(53)



Disc type: **VR** mode
[**NO**], [**YES**]

This option is available only in the playlist index screen.

DISC PROTECT

(54)



Disc type: **VR** mode
[**NO**], [**YES**]

PHOTOMOVIE

(57)



[**NO**], [**YES**]

DISC TITLE

(55)



STILL IMG OPER.**ERASE ALL IMAGES**

(48)



[NO], [YES]

DISPLAY SETUP**BRIGHTNESS**

Adjusts the brightness of the LCD screen.

- Use the joystick (◀▶) to adjust the brightness to your preference.
- Changing the brightness of the LCD screen does not affect that of the viewfinder or the recordings.

LCD MIRROR

[ON ON], [OFF OFF]

When the LCD panel is rotated 180 degrees to face the subject, most screen displays will disappear and the image displayed will be as if the subject was looking at a mirror.

TV SCREEN

[ON ON], [OFF OFF]

When set to [ON ON], the camcorder's on-screen displays will appear also on the screen of a connected TV or monitor.

DATA CODE

(48)



[DATE], [TIME], [DATE & TIME],
[CAMERA DATA]

MARKERS

[OFF OFF], [LEVEL(WHT)],
[LEVEL(GRY)], [GRID(WHT)],
[GRID(GRY)]

You can display a grid or a horizontal line at the center of the screen. The markers are available in white or gray. Use the markers as a reference to make sure your subject is framed correctly (vertically and/or horizontally).

- Using the markers will not affect the recordings on the disc.

LANGUAGE

(23)



[DEUTSCH], [ENGLISH], [ESPAÑOL],
[FRANÇAIS], [ITALIANO], [POLSKI],
[ROMÂNĂ], [TÜRKÇE], [РУССКИЙ],
[УКРАЇНСЬКА], [العربية], [فارسی],
[ภาษาไทย], [简体中文], [繁體中文], [한국어],
[日本語]

SYSTEM SETUP

VOLUME (30)



BEEP



[HIGH VOLUME],
[LOW VOLUME], [OFF OFF]

A beep will accompany some operations like turning on the camcorder, the self-timer countdown, etc. It also serves as a warning beep under unusual conditions.

POWER SAVE



[ON ON], [OFF OFF]

In order to save power when the camcorder is powered by a battery pack, it will automatically shut off if left without any operation for 5 minutes.

- Approximately 30 seconds before the camcorder shuts off, the message “ AUTO POWER OFF” will appear.
- In Quick-Start ready mode, the camcorder will shut off after the time selected for the [STANDBY OFF] setting.

STANDBY OFF (28)



[10 min], [20 min],
[30 min]

Select the length of time after which the camcorder will end the Quick-Start ready mode and shut off automatically.

FILE NOS.



[RESET], [CONTINUOUS]

Select the image numbering method to be used on a new disc.

Images are automatically assigned consecutive image numbers from 0101 to 9900, and stored in folders containing up to 100 images. Folders are numbered from 101 to 998.

[RESET]: Image numbers will restart from 101-0101 every time you insert a new disc.

[CONTINUOUS]: Image numbers will continue from the number following that of the last image recorded with the camcorder.

- If the disc you insert already contains an image with a larger number, a new image will be assigned a number one higher than that of the last image on the disc.
- We recommend using the [CONTINUOUS] setting.

TV TYPE



[NORMAL TV], [WIDE TV]

In order to display the picture in full and in the correct aspect ratio, select the setting according to the type of television to which you will connect the camcorder.

[NORMAL TV]: TV sets with 4:3 aspect ratio.

[WIDE TV]: TV sets with 16:9 aspect ratio.

- When the TV type is set to [NORMAL TV], if you play back a recording made in widescreen (16:9) the picture displayed on the LCD screen will be smaller than the full display area.

FIRMWARE

You can verify the current version of the camcorder's firmware. This menu option is usually grayed out.

DATE/TIME SETUP**T.ZONE/DST**

(23)

DATE/TIME

(24)

DATE FORMAT

[Y.M.D (2007.1.1 AM 12:00)],
[M.D,Y (JAN. 1, 2007 12:00 AM)],
[D.M.Y (1.JAN.2007 12:00 AM)]

Changes the date format for on-screen displays.

Using the Recording Programs



AUTO

The camcorder adjusts the focus, exposure and other settings automatically, allowing you to just point and shoot.



P : Flexible Recording Programs

[P PROGRAM AE]
(41)

[TV SHUTTER-PRIO. AE]
(41)

Special Scene Recording Programs:

[P PORTRAIT]

The camcorder uses a large aperture, achieving a focus on the subject while blurring other distracting details.



[S SNOW]

Use this mode to record in bright ski resorts. It prevents the subject from being underexposed.



[A SPOTLIGHT]

Use this mode to record spotlit scenes.



[S SPORTS]

Use this mode to record sports scenes such as tennis or golf.



[S BEACH]

Use this mode to record on a sunny beach. It prevents the subject from being underexposed.



[S FIREWORKS]

Use this mode to record fireworks.



[M NIGHT]

Use this mode to record in dimly lit places.



[S SUNSET]

Use this mode to record sunsets in vibrant colors.



P Flexible Recording: Changing the Aperture and Shutter Speed

Use the automatic exposure (AE) program or give priority to the exposure value or the shutter speed.

POINTS TO CHECK



Mode switch: P



Options

* Default value

[P PROGRAM AE]*
The camcorder automatically adjusts the aperture and shutter speed to obtain the optimal exposure for the subject.
[TV SHUTTER-PRIO.AE]
Set the shutter speed value. The camcorder automatically sets the appropriate aperture value. Use a high shutter speed to record fast moving subjects or a slow shutter speed to add a certain motion blur, emphasizing the feel of movement.

TO SET THE SHUTTER SPEED OR APERTURE VALUE

When you select [TV SHUTTER-PRIO.AE], a numeric value will appear next to the recording program icon.

1 If the joystick guide appears on the screen, press (SET) to hide it.

When the numeric value can be adjusted, small arrows will appear next to the number.

2 Adjust (▲▼) the numeric value (shutter speed or aperture value).







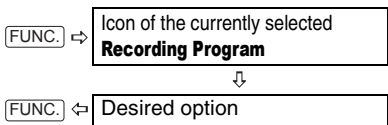

The number displayed will flash if the shutter speed is not appropriate for the recording conditions. In such case, select a different value.

NOTES

- Do not change the position of the mode switch while recording, as the brightness of the image may change abruptly.
- [TV SHUTTER-PRIO.AE]
 - If you use a slow shutter speed in dark places, you can obtain a brighter image, but the image quality may be lower, and the autofocus may not work well.
 - The image may flicker when recording with high shutter speeds.



Shutter speed guidelines

CAMERA 	1/6, 1/12, 1/25
CAMERA 	1/2, 1/3, 1/6, 1/12, 1/25
For recording subjects in dark places.	
CAMERA 	1/50
CAMERA 	1/50
For general recordings.	
CAMERA 	1/120
CAMERA 	1/120
For recording indoor sports scenes.	
CAMERA 	1/250, 1/500, 1/1000
CAMERA 	1/250, 1/500
For recording from within a car or train, or for recording moving subjects such as roller coasters.	
CAMERA 	1/2000
For recording outdoor sports such as golf or tennis on sunny days.	

Note that on screen only the denominator is displayed – “Tv 250” indicates a shutter speed of 1/250 second, etc.

Special Scene: Recording Programs to Match Special Conditions

Recording in a very bright ski resort or capturing the full colors of a sunset or a fireworks display becomes as easy as selecting a special scene recording program.

POINTS TO CHECK



Mode switch: **P**







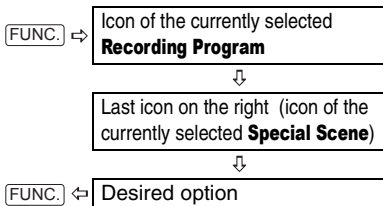





FUNC.

( 22)



NOTES

- Do not change the position of the mode switch while recording, as the brightness of the image may change abruptly.
- [] PORTRAIT/[] SPORTS/[] BEACH/[] SNOW
 - The picture may not appear smooth during playback.
- [] PORTRAIT
 - The blur effect of the background increases the more you zoom in (T).
- [] NIGHT
 - Moving subjects may leave a trailing afterimage.
 - Picture quality may not be as good as in other modes.
 - White points may appear on the screen.
 - Autofocus may not work as well as in other modes. In such case, adjust the focus manually.
- [] SNOW/[] BEACH
 - The subject may become overexposed on cloudy days or in shaded places. Check the image on the screen.
- [] FIREWORKS
 - To avoid camcorder shake, we recommend using a tripod. Make sure to use a tripod especially in **CAMERA** , as the shutter speed slows down.

Adjusting the Picture: Exposure, Focus and Color

Manual Exposure Adjustment

At times, backlit subjects may appear too dark (underexposed) or subjects under very strong lights may appear too bright or glaring (overexposed). To correct this, you can manually adjust the exposure.

POINTS TO CHECK



Mode switch: **P** (except for the [FIREWORKS] recording program).

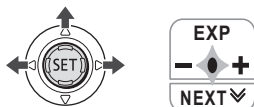

1 If the joystick guide does not appear on screen, press (SET) to display it.

2 Push the joystick (▲) toward [EXP].

- If [EXP] does not appear on the joystick guide, repeatedly push the joystick (▼) toward [NEXT] to display the joystick guide in the illustration above.
- The exposure adjustment indicator and the neutral value “±0” appear on the screen.
- If you operate the zoom during exposure lock, the brightness of the image may change.

3 Adjust (◀▶) the brightness of the image as required.

- The adjustment range and the length of the exposure adjustment indicator will vary depending on the brightness of the picture at the time you locked the exposure.
- Pushing the joystick (▲) toward [EXP] again will cancel the exposure lock and return the camcorder to automatic exposure.

Manual Focus Adjustment

Autofocus may not work well on the following subjects. In such case, focus manually.

Reflective surfaces



Subjects with low contrast or without vertical lines



Fast Moving Subjects



Through wet windows



Night Scenes



POINTS TO CHECK



Adjust the zoom before you start the procedure.

Mode switch: **P**

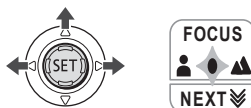

1 If the joystick guide does not appear on screen, press (SET) to display it.

2 Push the joystick (▲) toward [FOCUS].

- If [FOCUS] does not appear on the joystick guide, repeatedly push the joystick (▼) toward [NEXT] to display the joystick guide in the illustration above.
- “MF” appears.

3 Adjust (◀▶) the focus as required until the image appears focused.

- Push the joystick (▶) toward ▲ for a farther focal distance or push it (◀) toward ■ for a closer focal distance.
- Pushing the joystick (▲) toward [FOCUS] again will return the camcorder to autofocus.

i NOTES

- The camcorder will automatically return to autofocus when you set the mode switch to **AUTO**.
- Readjust the focus when you have turned off the camcorder.

Infinity Focus

Use this function when you wish to focus on faraway subjects such as mountains or fireworks.

✓ POINTS TO CHECK



Adjust the zoom before you start the procedure.

Mode switch: **P**



1 If the joystick guide does not appear on screen, press (SET) to display it.

2 Keep the joystick pushed (▲) toward [FOCUS] for more than 2 seconds.

- ∞ appears.
- Pushing the joystick (▲) toward [FOCUS] again will return the camcorder to autofocus.

i NOTES

If you operate the zoom or the joystick (◀▶) during infinity focus, ∞ changes to "MF" and the camcorder returns to manual focusing mode.

White Balance

The white balance function helps you accurately reproduce colors under different lighting conditions so that white objects will always look truly white in your recordings.

✓ POINTS TO CHECK



Mode switch: **P**

Options

* Default value

[AWB AUTO]*
Settings are automatically set by the camcorder. Use this setting for outdoor scenes.
[☀ DAYLIGHT]
For recording outdoors on a bright day.
[☀ TUNGSTEN]
For recording under tungsten and tungsten type (3-wavelength) fluorescent lighting.
[☑ SET]
Use the custom white balance setting to make white subjects appear white under colored lighting.

FUNC.

(**U** 22)



FUNC. ⇒

Icon of the currently selected **White Balance**



FUNC. ⇐

Desired option*

* When you select [**☑** SET], do not press [**FUNC.**] and continue instead with the procedure below.

TO SET THE CUSTOM WHITE BALANCE

1 Point the camcorder at a white object, zoom in until it fills the whole screen and press (SET).

When the adjustment is completed,  stops flashing and stays on. The camcorder retains the custom setting even if you turn off the camcorder.

2 Press [FUNC.] to save the setting and close the menu.

NOTES

When you have set the custom white balance:

- Depending on the light source,  may keep flashing. The result will still be better than with [AWB AUTO].

- Reset the white balance when the lighting condition changes.

- Turn off the digital zoom.

- The camcorder retains the custom white balance setting even if you turn it off.

- Custom white balance may provide better results in the following cases:

- Changing lighting conditions

- Close-ups

- Subjects in a single color (sky, sea or forest)

- Under mercury lamps and certain types of fluorescent lights

Image Effects

You can use the image effects to change the color saturation and contrast to record images with special color effects.

POINTS TO CHECK



Mode switch: P

Options

* Default value

[<OFF IMAGE EFFECT OFF]*
Records with no image enhancing effects.
[<VIVID]
Emphasizes the contrast and color saturation.
[<NEUTRAL]
Tones down the contrast and color saturation.
[<SD SOFT SKIN DETAIL]
Softens the details in the skin tone area for a more complimentary appearance. To obtain the best effect, use this setting when recording a person in close-up. Note that areas similar to the skin color may lack in detail.



[FUNC.] → Icon of the currently selected **Image Effect**

↓
[FUNC.] ⇐ Desired option

Still Image Recording Options

Selecting the Size and Quality of Still Images

Still images are recorded on the disc using the JPEG (Joint Photographic Experts Group) compression. As a general rule select a larger image size for higher quality.



Options

Image size options vary depending on the model. The following table summarizes the approximate numbers of still images that can be recorded on different medias by image size/quality.

* Default value

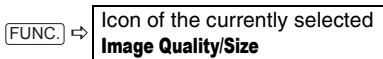
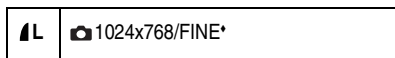

Desired image size*

↓ ↑
Press (SET)

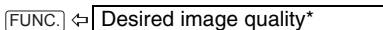

* The number displayed on the right corner indicates the approximate number of images that can be recorded with the current quality/size setting.

Approximate number of still images on a disc

Disc Type/ Disc Specification	DVD-R or DVD-RW VIDEO mode			DVD-R DL VIDEO mode			DVD-RW VR mode		
L 1024x768	2,690	3,910	7,830	4,890	7,115	9,999	2,735	3,980	7,965
S 640x480	6,625	9,570	9,999	9,999	9,999	9,999	6,740	9,735	17,525 ²

¹ : [SUPER FINE], : [FINE], : [NORMAL]

² This is the number of images that can be recorded on the disc. However, the maximum number of remaining still images displayed on the screen will be 9999.

Automatic Focus Priority

When the focus priority is activated, the camcorder records a still image only after the focus has been adjusted automatically.



POINTS TO CHECK



(10)

Mode switch at **AUTO**:

The focus priority cannot be turned off.

Mode switch at **P**:

You can turn off the focus priority and you can also select the AF (autofocus) frame to be used.

Options

* Default value

[**AiAF** ON: **AiAF***]

(Mode switch: **P***, **AUTO**)

Depending on the shooting conditions, one or more AF frames out of the nine frames available are automatically selected and the focus is fixed on them.

[**□** ON: **CENTER**]

(Mode switch: **P***)

The focus is automatically fixed to the center AF frame. This is convenient for making sure the focus is exactly where you want it. In this mode, a single focusing frame appears in the center of the screen.

[**OFF** OFF]

Select this option if you wish to record a still image as soon as you press **[PHOTO]**.

* Except for the [**FIREWORKS**] recording program.

FUNC.

(22)

FUNC.



FUNC. →

MENU



CAMERA SETUP



FOCUS PRI.



FUNC. ⇄

Desired option



NOTES

In the [**FIREWORKS**] recording program the focus priority is automatically set to [**OFF** OFF].

Other Functions

On-Screen Displays

The camcorder keeps a data code containing the date and time and other camera data (shutter speed, exposure, etc.) registered at the time of recording. You can select the data to be displayed.

Turning the On-Screen Displays On/Off

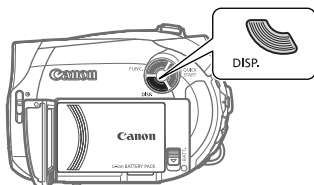

Repeatedly press **DISP.** to turn the on-screen displays on/off in the following sequence:



- All displays on
- All displays off¹



- All displays on
- Data code² only
- All displays off



- All displays on (including the histogram³)
- Regular displays only
- All displays off

¹ However, the level marker, the disc type icon and the ● and ●● icons will still appear on the screen.

² Data code: Time, date and camera data at the time of recording. The contents to be displayed can be selected as explained in the following section.

³ Histogram display: For still images you can display the complete camera data registered at the time of recording. For details on how to read the histogram display, refer to the following section.

Selecting the Data Code

You can select the data code to be displayed when playing back movies.



Options

* Default value

[DATE], [TIME]
Displays the date or time when the scene or still image was recorded.
[DATE & TIME]*
Displays both the date and time of the recording.
[CAMERA DATA]
Displays the aperture (f-stop) and shutter speed used when recording the image.

FUNC.

(22)

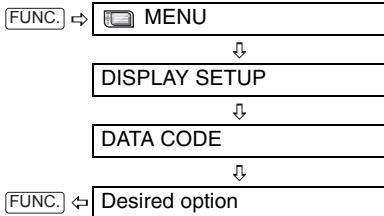

Reading the Histogram Display

When viewing still images you can display the histogram and the icons of all the functions used at the time of recording. Use the histogram as a reference to verify the correct exposure of the still image.

The area to the right of the histogram represents highlights and the left side represents shadows. A still image whose

histogram skews to the right is relatively bright; while one whose histogram peaks to the left, is relatively dark.

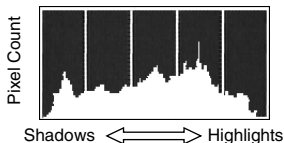

i NOTES

The histogram will appear also while reviewing a still image immediately after recording it.

Self Timer

POINTS TO CHECK



CAMERA : Set the camcorder in record pause mode.

FUNC.
(22)

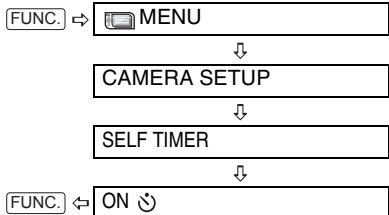

↻ appears.

CAMERA :

Press **[Start/Stop]**.

The camcorder starts recording after a 10-second countdown. The countdown appears on the screen.

CAMERA :

Press **[PHOTO]**, first halfway to activate the autofocus and then fully to record the still image.

The camcorder will record the still image after a 10-second countdown. The countdown appears on the screen.

i NOTES

Once the countdown has begun, you can press **[Start/Stop]** (when recording movies) or press **[PHOTO]** fully (when recording still images) to cancel the self timer. The self timer will also be canceled if you turn off the camcorder.

Digital Effects

POINTS TO CHECK



Mode switch: **P**

CAMERA : **[F1] BLK&WHT**, **[F2] SEPIA** only.

Options

* Default value

[F1] D.EFFECT OFF*
 Select this setting when you do not intend to use the digital effects.

[F1] FADE-T (fade trigger), **[F2] WIPE**
 Select one of the faders to begin or end a scene with a fade from or to a black screen.

[F1] BLK&WHT]
Records images in black and white.
[F2] SEPIA]
Records images in sepia tones for an "old" look.
[F3] ART], [F4] MOSAIC]
Select one of the other digital effects to add flavor to your recordings.

i NOTES

- When you apply a fader, not only the picture but also the sound will fade in or out. When you apply an effect, the sound will be recorded normally.
- The camcorder retains the setting last used even if you turn off the digital effects or change the recording program.

Setting

FUNC.

(22)



FUNC.

⇒ Icon of the currently selected Digital Effect



FUNC.**

⇐ Desired fader/effect*

* You can preview the effect on the screen.

** The icon of the selected effect appears.

Applying



- 1 If the joystick guide does not appear on screen, press (SET) to display it.**
- 2 Push the joystick (▲) toward [NEXT].**
 - If [NEXT] does not appear on the joystick guide, repeatedly push the joystick (▼) toward [NEXT] to display the joystick guide in the illustration above.
 - The icon of the selected effect turns green.
 - Push the joystick (▲) toward [NEXT] again to deactivate the fader/effect.

To FADE IN

Push the joystick (▲) toward [NEXT] in record pause mode (●||), then press [Start/Stop] to start recording with a fade in.

To FADE OUT

Push the joystick (▲) toward [NEXT] while recording (●), then press [Start/Stop] to fade out and pause the recording.

To ACTIVATE AN EFFECT

CAMERA [CAMERA] : Push the joystick (▲) toward [NEXT] while recording or in record pause mode.

CAMERA [CAMERA] : Push the joystick (▲) toward [NEXT] and then press [PHOTO] to record the still image.

Managing Scenes

Creating a Playlist

Create a playlist to easily edit your movies. Include in your playlist only the scenes you prefer or change the order in which they will be played back, without affecting your original recordings. After you add scenes to the playlist you will have two types of index screens:

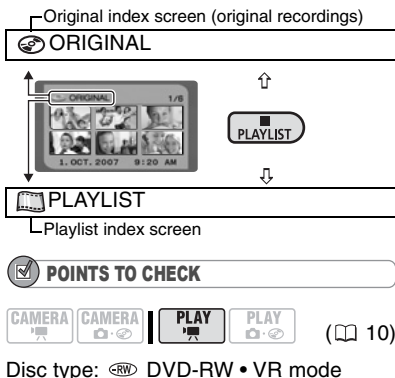

Adding Scenes to the Playlist

Options

[ALL SCENES]
Adds all scenes in the original index screen to the playlist.
[ONE SCENE]
Adds only the selected scene to the playlist.
[CANCEL]
Returns to the original index screen.

From the original index screen, select (▲▼, ◀▶) the scene to add to the playlist. To add all scenes, there is no need to select any particular scene.

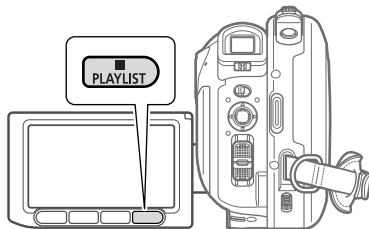
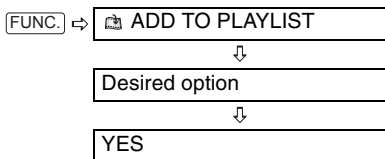

When the operation is completed “ADDED TO PLAYLIST” will be displayed. Press [PLAYLIST] to check the scenes in the playlist index screen.

Moving Scenes in the Playlist

From the original index screen, press **PLAYLIST**. From the playlist index screen, select (**▲▼**, **◀▶**) the scene to move.



FUNC. → **MOVE**

Move (**▲▼**, **◀▶**) the orange marker to the new position of the scene and press (**SET**).

YES

Deleting Scenes

You can delete those scenes that you are not interested in keeping. Remember that when you delete scenes in the playlist, you do not affect your original recordings; However, when you delete an original recording, it will be deleted also from the playlist.

IMPORTANT

- Be careful when deleting original recordings. Once deleted, an original scene cannot be recovered.
- Do not change the position of the power switch or the **PLAY/PAUSE** switch while the scene is being deleted.

NOTES

- Scenes cannot be deleted when the disc is protected (54).
- You may not be able to delete scenes shorter than 5 seconds.

Deleting a Single Scene

POINTS TO CHECK



Disc type: **CRW** DVD-RW • VR mode

From the original index screen, select (**▲▼**, **◀▶**) the scene to delete. To delete a scene only in the playlist, press **PLAYLIST** first, and then select the scene.



FUNC. → **DELETE**

YES

Deleting a Scene Just After Recording

POINTS TO CHECK



Disc type: **CRW** DVD-RW •
VIDEO or VR mode



Immediately after recording a scene:

- 1 If the joystick guide does not appear on screen, press (SET) to display it.**
- 2 Push the joystick (◀) toward (G).**
If (G) does not appear on the joystick guide, repeatedly push the joystick (▼) toward [NEXT] to display the joystick guide in the illustration above. When the mode switch is set to **AUTO**, only one joystick guide will appear.
- 3 While reviewing the scene, select (◀▶) and press (SET).**

4 Select (◀▶) [YES] and press (SET).

i NOTES

You will not be able to delete the last scene if after the scene was recorded you changed the operating mode, turned off the camcorder or removed the disc.

Deleting All Scenes

✓ POINTS TO CHECK



Disc type: (DVD) DVD-RW • VR mode

To delete all the scenes from the original index screen, follow the procedure below. This will delete also the whole playlist. If you only want to delete all the scenes from the playlist (without affecting the original recordings), press [PLAYLIST] first and then continue as follows.

FUNC.
(12)

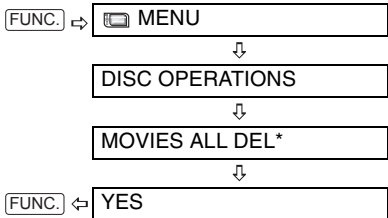

* When you are deleting the playlist, this menu option will be replaced by [PLAYLST ALL DEL].

Dividing a Scene

You can divide your recordings in order to leave only the best parts and later cut out the rest. Remember that when you divide scenes in the playlist, you do not affect your original recordings.

i NOTES

Photomovie scenes (12) and very short scenes (1 second or less) cannot be divided.

✓ POINTS TO CHECK



Disc type: (DVD) DVD-RW • VR mode

From the original index screen, select (▲▼, ▶◀) the scene to divide. To divide a scene only in the playlist, press [PLAYLIST] first, and then select the scene.

FUNC.
(12)

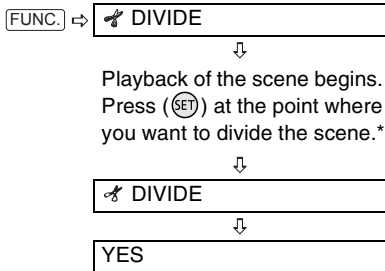

* You can use the following icons and the special playback modes (13) to bring the scene to a precise point.

- ⏮▶▶: Skip to the beginning of the current/next scene.
- ◀||▶: One frame reverse/advance.

Managing the Disc

Protecting the Disc

You can protect the whole disc to prevent the accidental erasure of important recordings. Follow the same procedure to remove the protection of a protected disc.

! IMPORTANT

Initializing the disc (📖 54) will permanently erase all recordings, even if the disc is protected.

✔ POINTS TO CHECK



Disc type: DVD-RW • VR mode



FUNC. → **MENU**



DISC OPERATIONS



DISC PROTECT



FUNC. ← **YES**

Initializing the Disc

You need to initialize a DVD-RW disc when first inserting it into the camcorder and you may have to initialize a disc if you get the message “UNABLE TO RECOGNIZE THE RECORDING MODE OF THE DISC”. You can also choose to initialize the disc if you wish to erase all the recordings on the disc or in order to change the disc specification.

! IMPORTANT

- Initializing the disc will permanently erase all recordings, even if the disc is protected. The lost original recordings cannot be recovered.
- Initialize all DVD-RW discs before using them with this camcorder.

✔ POINTS TO CHECK



Disc type: DVD-RW •
VIDEO or VR mode

Options

[VIDEO] mode

Most DVD players will play the disc, but except for the disc title, the recordings cannot be edited with the camcorder.

[VR] mode

You will have the option to edit the recordings with the camcorder, but the disc can only be played in VR mode-compatible DVD players and computer DVD drives.



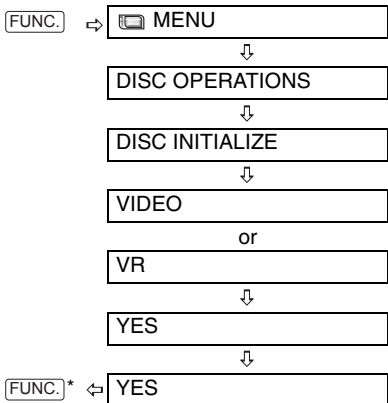

* Close the menu only after the screen display returns to the [DISC OPERATIONS] menu.

Changing the Disc Title

Before you finalize your disc*, you can give it a title. The disc title will be displayed on the index screen when playing the finalized disc in most DVD players.

* You can change the title of DVD-RW discs recorded in VR mode also after having finalized them.

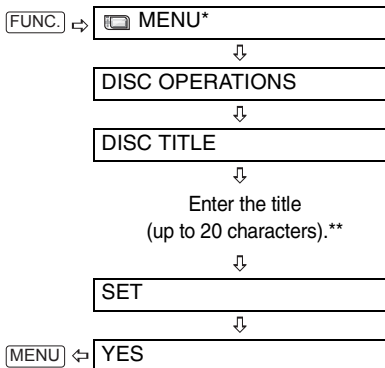

* Only when using a DVD-RW recorded in VR mode. With discs recorded in VIDEO mode, pressing [FUNC.] will open the menu directly on the setup menu screen.

** Select one character at a time and press (SET) to add it to the title. Select [BACKSPACE] and press (SET) to delete the character to the left of the cursor's position.

Managing Photos

Erasing Photos

You can erase still images recorded on the disc (DVD-RW only).

IMPORTANT

Be careful when erasing images. Erased images cannot be recovered.

NOTES

Images on a protected disc cannot be erased.

Erasing a Single Image

POINTS TO CHECK



(10)

Disc type: <RW> DVD-RW • VR mode



- 1 If the joystick guide does not appear on screen, press (SET) to display it.
- 2 Push the joystick (▼) toward ↗.
- 3 Select (◀▶) [ERASE] and press (SET).

Erasing a Single Image Just After Recording

You can erase a still image just recorded, while reviewing it immediately after recording it.

POINTS TO CHECK



(10)

Disc type: <RW> DVD-RW •
VIDEO or VR mode



While reviewing the image immediately after recording:

- 1 Push the joystick (▼) toward ↗.
- 2 Select (◀▶) [ERASE] and press (SET).

Erasing All Images

The following procedure will erase all the still images from the disc.

POINTS TO CHECK



(10)

Disc type: <RW> DVD-RW • VR mode

FUNC.

(22)

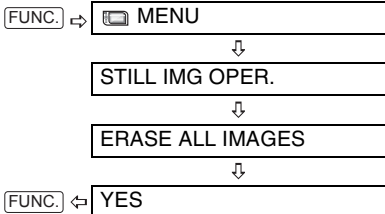

Converting Photos into Photomovie Scenes

Still images are recorded using JPEG compression, but a DVD player only recognizes the MPEG standard. Thus, to play back your still images with your DVD player, first you need to create a Photomovie scene – a slide show of all still images on the disc, where each image will be displayed for approx. 3 seconds.

POINTS TO CHECK



CAMERA  **CAMERA** | **PLAY**  **PLAY**  (10)

We recommend setting [TV TYPE] to [ NORMAL TV] (38) before creating the Photomovie scene.

Converting a Single Image



Select (◀▶) the still image you want to convert to a Photomovie scene.

FUNC.
(22)  **FUNC.**  

FUNC.   **CONVERT TO SCENE**
↓
FUNC.  **EXECUTE**

Converting All Images

FUNC.
(22)  **FUNC.**  

FUNC.  **MENU**
↓
DISC OPERATIONS
↓
PHOTOMOVIE
↓
FUNC.  **YES**

NOTES

- If the disc becomes full while creating a Photomovie scene, the operation will be canceled.
- This function does not affect the original still images.

Finalizing the Disc

To play the disc you recorded on a DVD player, a computer's DVD drive or other digital device, you need to finalize it first. You do not need to finalize the disc to play back your recordings with the camcorder connected to the TV.

To view your still images on a DVD player you will need to convert them to Photomovie scenes beforehand (📖 57).

! IMPORTANT

- Be sure to finalize the disc in normal room temperatures. If the procedure was not completed correctly due to high temperature, let the camcorder cool off before resuming operation.
- Place the camcorder on a table or other stable surface before starting the procedure. Subjecting the camcorder even to slight impacts (for example to place it on a table or to disconnect the AV cable) after the finalization process started may result in permanent data loss.

- Always power the camcorder using the compact power adapter. The operation cannot be started if the camcorder is powered only with the battery pack.
- Avoid the following actions while the operation is in progress. Failing to do so can interrupt the process and result in permanent data loss.
 - Do not move the camcorder.
 - Do not disconnect the compact power adapter.
- Depending on the type of disc and the disc specification, after finalizing the disc you may not be able to initialize the disc, edit your recordings or add new recordings to the disc.
- Do not finalize with this camcorder discs that were not recorded using it.

i NOTES

The time required to complete the operation will vary depending on the recording conditions and the remaining free space on the disc.

Restrictions after Disc Finalization

	Additional Recordings	Edit Recordings	Initializing the Disc	Unfinalizing the Disc
DVD-R/DVD-R DL in VIDEO mode	–	–	–	–
DVD-RW in VIDEO mode	●*	–	●	●
DVD-RW in VR mode	●	●	●	–

* You will need to unfinalize the disc first.

Finalizing the Disc

The length of the finalization process depends on the scenes recorded and the remaining free space on the disc.

POINTS TO CHECK



Power the camcorder using the compact power adapter.

FUNC. (22)

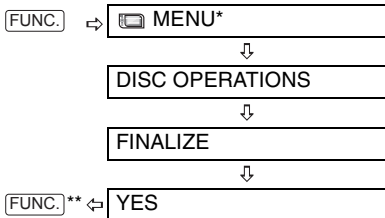

* Only when using a DVD-RW recorded in VR mode. With discs recorded in VIDEO mode, pressing [FUNC.] will open the menu directly on the setup menu screen.

**During the disc finalization a progress bar is displayed. Close the menu only after the screen display returns to the [DISC OPERATIONS] menu.

Playing Back your Disc on a DVD Player or a Computer's DVD Drive

After finalizing the disc, you can play it on DVD players compatible with the type of disc you used (DVD-R, DVD-R DL or DVD-RW). You cannot play back discs that have not yet been finalized on an external DVD device.

For details about disc compatibility refer to the instruction manual of the DVD player or DVD drive.

ON A DVD PLAYER

- 1 Turn on the TV and DVD player.
- 2 Insert a finalized disc in the DVD player.
- 3 Select the scene you want to play from the index screen.

ON A COMPUTER'S DVD DRIVE

- 1 Insert a finalized disc in the DVD drive.
- 2 Run the DVD playback software.
 - Refer also to the instruction manual and help modules of your DVD playback software.
 - To view still images recorded on the disc, close first any DVD playback software that may be running.

NOTES

- DVD-RW discs recorded in VR mode can only be played on VR mode-compatible DVD players.
- Depending on your DVD device you may not be able to play the disc.
- The resolution of Photomovie scenes will be lower than that of the original still images.
- In order to play the disc on a computer you need to have DVD playback software installed and running. Also, in order to play back a DVD-R DL you must have a DVD drive capable of reading dual-layered DVD discs.

Unfinalizing the Disc - Additional Recordings on a Finalized Disc

Unfinalize a disc to allow recording additional movies on the disc even after it was finalized.

IMPORTANT

- Be sure to unfinalize the disc in normal room temperatures. If the procedure was not completed correctly due to high temperature, let the camcorder cool off before resuming operation.

- Place the camcorder on a table or other stable surface before starting the procedure. Subjecting the camcorder even to slight impacts (for example to place it on a table or to disconnect the AV cable) after the unfinalization process started may result in permanent data loss.

- Always power the camcorder using the compact power adapter. The operation cannot be started if the camcorder is powered only with the battery pack.

- Avoid the following actions while the operation is in progress. Failing to do so can interrupt the process and result in permanent data loss.

- Do not move the camcorder.
- Do not disconnect the compact power adapter.

- Only discs that were finalized using this camcorder can be unfinalized with it.

Discs that Can be Unfinalized

DVD-R/DVD-R DL in VIDEO mode	—
DVD-RW in VIDEO mode	●
DVD-RW in VR mode	— You can record additional scenes even without unfinalizing the disc

POINTS TO CHECK



Power the camcorder using the compact power adapter.

Disc type: (RW) DVD-RW • VIDEO mode

FUNC.
(22)



FUNC.

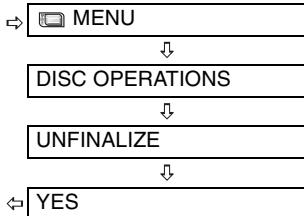

* During the disc unfinalization a progress bar is displayed. Close the menu only after the screen display returns to the [DISC OPERATIONS] menu.

Connecting to a TV or VCR

Connection Diagrams

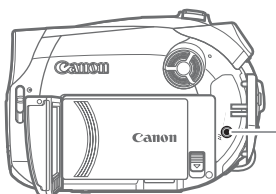



Open the terminal cover to access

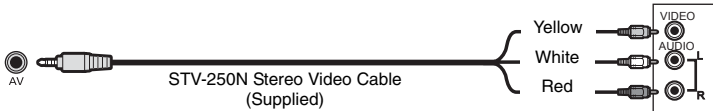

AV Terminal

Sound from the built-in speaker will be muted while the STV-250N stereo video cable is connected to the camcorder.

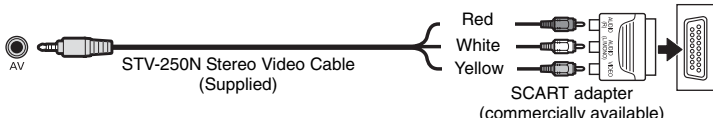
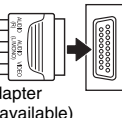
Terminal on the Camcorder	Connecting Cable	Terminal on the Connected Device
<p>1 Output connection (Signal Flow →) to a TV or VCR with AV Terminals.</p> 	<p>STV-250N Stereo Video Cable (Supplied)</p>	
<p>2 Output connection (Signal Flow →) to a TV or VCR with SCART terminal. First, connect a SCART adapter to the SCART terminal on the TV or VCR and then connect the STV-250N Stereo Video Cable to the adapter.</p> 	<p>STV-250N Stereo Video Cable (Supplied)</p>	 <p>SCART adapter (commercially available)</p>

Playback on a TV Screen

POINTS TO CHECK



Before connecting the camcorder, select the [TV TYPE] setting according to the TV set to which you will connect the camcorder - [WIDE TV]: TV sets with 16:9 aspect ratio or [NORMAL TV]: TV sets with 4:3 aspect ratio (□ 38).

Connecting

Connect the camcorder to the TV following one of the connection diagrams shown in the previous section *Connection Diagrams* (□ 61).

Playback

1 Turn on the camcorder and the connected TV or VCR.

On a TV: Select as the video input the same terminal to which you connected the camcorder. On a VCR: Set the input selector to the external video input (usually labeled LINE IN).

2 Start the playback of the movies (□ 29) or still images (□ 30).

NOTES

- Turn off all the devices before starting the connections.
- Sound from the built-in speaker will be muted while the STV-250N Stereo Video Cable is connected to the camcorder.
- We recommend powering the camcorder using the compact power adapter.

Recording to a VCR or Digital Video Recorder

You can copy your recordings by connecting the camcorder to a VCR or a digital video device.



Connecting

Connect the camcorder to the VCR following one of the connection diagrams shown in the previous section *Connection Diagrams* (□ 61).

Recording

- 1 Connected device: Load a blank cassette or disc and set the device to record pause mode.**
- 2 This camcorder: Locate the scene you wish to copy and pause playback shortly before the scene.**
- 3 This camcorder: Resume the movie playback.**
- 4 Connected device: Begin recording when the scene you wish to copy appears. Stop recording when copying is complete.**
- 5 This camcorder: Stop playback.**

NOTES

- We recommend powering the camcorder using the compact power adapter.
- By default, the on-screen displays will be embedded in the output video signal, but you can change the displays by repeatedly pressing [DISP.] (□ 48).



Troubleshooting

If you have a problem with your camcorder, refer to this checklist. Consult your dealer or a Canon Service Center if the problem persists.

Power Source



Problem	Solution	
<ul style="list-style-type: none"> • Camcorder will not turn on. • The camcorder switches off by itself. • The disc compartment cover will not open. • LCD/viewfinder switches on and off. 	Battery pack is exhausted. Replace or charge the battery pack.	17
	Attach the battery pack correctly.	
The charge indicator flashes rapidly (approx. twice per second)	Charging has stopped because the compact power adapter or the battery pack is faulty.	–
<ul style="list-style-type: none"> • Battery pack will not charge. • The charge indicator flashes very slowly (about once every 2 seconds). 	Charge the battery pack in temperatures between 0 °C and 40 °C.	–
	Battery packs become hot with use and may not charge. When the battery pack is outside the charging temperature range, the CHG (charge) indicator will flash irregularly. The charging will start once the battery pack temperature is below 40 °C.	–
	The battery pack is damaged. Use a different battery pack.	–

Recording/Playback

Problem	Solution	
Buttons will not work.	Turn on the camcorder.	–
	Load a disc.	19
Abnormal characters appear on the screen. The camcorder does not operate properly.	Disconnect the power source and reconnect it after a short time. If the problem still persists, disconnect the power source and press the RESET button with a pointed item. Pressing the RESET button resets all settings.	–
“  ” flashes on the screen.	Load a disc.	19
“  ” flashes on the screen.	Battery pack is exhausted. Replace or charge the battery pack.	17
Video noise appears on screen.	When using the camcorder in a room where a plasma TV is located, keep a distance between the camcorder and the plasma TV.	–
Video noise appears on the TV screen.	When using the camcorder close to devices that emit strong electromagnetic fields (plasma TVs, cellular phones, etc.), keep a distance between the camcorder and these devices.	–
Even without a disc loaded, when closing the disc compartment cover a motor sound can be heard.	The camcorder is checking if a disc is loaded or not. This is not a malfunction.	–



Problem	Solution	
The disc cannot be ejected.	Turn off the camcorder, disconnect the compact power adapter and remove the battery pack. Restore the power supply and try again.	–
	The camcorder has exceeded its operational temperature. Turn off the camcorder and let it cool down before resuming use.	–
The disc cannot be recognized.	The disc is dirty. Clean the disc with a soft lens-cleaning cloth. If the problem persists replace the disc.	70
	The disc is not correctly loaded. Check the disc.	19
	Verify that the camcorder supports the type of DVD disc you inserted.	3
The camcorder vibrates.	Depending on the condition of the disc, the camcorder might vibrate occasionally. This is not a malfunction.	–
<ul style="list-style-type: none"> The disc's rotation can be faintly heard. Occasionally the operation sound can be heard. 	The disc is activated from time to time. This is not a malfunction.	–
After using the camcorder for a long time, "🔴" lights up in red.	This is not a malfunction. Turn the camcorder off and let it cool for a while before resuming operation.	–

Recording

Problem	Solution	
Image will not appear on the screen.	Set the camcorder to  .	25
	Open the lens cover.	
"SET THE TIME ZONE, DATE AND TIME" appears on the screen.	Set the time zone, date and time.	23
	Recharge the built-in lithium battery and set the time zone, date and time.	70
Pressing the start/stop button will not start recording.	Set the camcorder to  .	25
	Load a recommended disc.	4
	The disc is full ("🔴END" flashes on the screen). Delete some recordings (DVD-RW in VR mode) to free some space or replace the disc.	19 52
	The camcorder has exceeded its operational temperature. Turn off the camcorder and let it cool down before resuming use.	–
	Remove the disc protection.	54
	Unfinalize the disc (DVD-RW in VIDEO mode).	60
Even after stopping recording, the disc access indicator does not go off.	The scene or still image is being recorded on the disc. This is not a malfunction.	25 27
The point where the start/stop button was pressed does not match the beginning/end of the recording.	There is a slight interval between pressing the start/stop button and the actual start of the recording on the disc. This is not a malfunction.	–

Problem	Solution	
The recording suddenly stops shortly after starting recording.	The disc is dirty. Clean the disc with a soft lens-cleaning cloth. If the problem persists replace the disc.	70
	The camcorder has exceeded its operational temperature. Turn off the camcorder and let it cool down before resuming use.	–
Camcorder will not focus.	Autofocus does not work on that subject. Focus manually.	43
	Adjust the viewfinder with the dioptic adjustment lever.	20
	Lens is dirty. Clean the lens with a soft lens-cleaning cloth. Never use tissue paper to clean the lens.	71
Sound is distorted.	When recording near loud sounds (such as fireworks or concerts), sound may become distorted. This is not a malfunction.	–
A vertical light bar appears on the screen.	Bright light in a dark scene may cause a vertical light bar (smear) to appear. This is not a malfunction.	–
Viewfinder picture is blurred.	Adjust the viewfinder with the dioptic adjustment lever.	20

Playback/Editing

Problem	Solution	
Pressing the playback button does not start playback.	Load a disc.	19
	Set the camcorder to  .	29
	You may not be able to play with this camcorder, discs recorded or edited with other DVD recorders or computer DVD drives.	–
	If using a single-sided disc, check that the disc is inserted with the label side facing up.	19
	The camcorder has exceeded its operational temperature. Turn off the camcorder and let it cool down before resuming use.	–
<ul style="list-style-type: none"> • During playback there is video noise and the sound is distorted. • The disc cannot be read. 	The disc is dirty. Clean the disc with a soft lens-cleaning cloth.	70
	You may not be able to play with the camcorder discs recorded or edited with other DVD recorders or computer DVD drives.	–
Cannot add scenes to the playlist.	The disc is full (“  END” flashes on the screen). Delete some recordings to free some space.	52
	You cannot add more than 999 scenes to the playlist.	–
	Remove the disc protection.	54
Cannot divide the scene.	You cannot edit or delete scenes on a disc that was protected in another digital device.	–
	You cannot divide the scene if there are already 999 scenes on the disc.	–
	You cannot divide the scene if it is too short (1 second or less).	–



Problem	Solution	
Cannot edit the disc title.	You cannot add a title to a DVD-R/DVD-R DL disc after it was finalized.	58
	Unfinalize the disc first (DVD-RW in VIDEO mode).	60
	You may not be able to edit the title if you entered it with another digital device.	–
	Remove the disc protection.	54
Cannot create a Photomovie scene.	The disc is full ("END" flashes on the screen). Delete some recordings (DVD-RW in VR mode) to free some space.	52
Cannot edit or delete scenes.	Remove the disc protection.	54
	You cannot edit or delete scenes on a disc that was protected with another digital device.	–
	Scenes cannot be deleted in a DVD-R/DVD-R DL disc or a DVD-RW disc recorded in VIDEO mode.	–
Cannot finalize the disc.	You cannot finalize a disc (DVD-R/DVD-R DL or DVD-RW) recorded in VIDEO mode if it contains only still images. Record at least one scene before finalizing the disc.	25 58
	The camcorder has exceeded its operational temperature. Turn off the camcorder and let it cool down before resuming use.	–
No sound from the built-in speaker.	Open the LCD panel.	–
	Speaker volume is turned off. Adjust the volume with the joystick and joystick guide in (PLAY) mode.	30
	Disconnect the stereo video cable from the camcorder.	–

Playing Back the Disc in an External DVD Device

External DVD device refers to DVD players, DVD recorders, computer's DVD drives and other digital devices.

Problem	Solution	
There is a brief stop between scenes.	Depending on the DVD player, there might be a very short stop between scenes during playback.	–
Disc is running, but image will not appear on the TV screen.	The video input on the TV is not set to the video terminal to which you connected the camcorder. Select the correct video input.	61
	You attempted to play back or dub an incompatible disc. Stop playback/dubbing.	–
The disc cannot be recognized by the device. Or, even though the disc is read, cannot play back the disc or the picture is distorted.	The disc is dirty. Clean the disc with a soft lens-cleaning cloth.	70
	The disc has not been finalized.	58
	DVD-RW discs in VR mode can only be played back with VR mode-compatible DVD players. Refer to the instruction manual of your DVD device.	–
Cannot edit my recordings or add recordings to the disc with the DVD device.	It may not be possible to edit or add recordings with an external DVD recorder on a disc recorded with this camcorder.	–

List of Messages

Message	Explanation	
SET THE TIME ZONE, DATE AND TIME	You have not set the time zone, date and time. This message appears each time you turn the power on until you set the time zone, date and time.	23
CHANGE THE BATTERY PACK	Battery pack is exhausted. Replace or charge the battery pack.	17
CANNOT ENTER THE  STANDBY MODE NOW	The camcorder cannot enter the Quick Start standby mode while the disc is being recognized after first inserting it or if the remaining battery charge is too low.	28
UNABLE TO RECOGNIZE THE RECORDING MODE OF THE DISC	The disc may not be recognized by this camcorder if it was initialized with a different device.	–
	You inserted a disc recorded in a different Television System (NTSC).	–
<ul style="list-style-type: none"> • TEMPERATURE TOO HIGH CANNOT RECORD • TEMPERATURE TOO HIGH CANNOT REMOVE DISC 	The camcorder has exceeded its operational temperature. Disconnect the compact power adapter and remove the battery and let the camcorder cool down before resuming use.	–
CANNOT RECORD CHECK THE DISC	There is a problem with the disc. Replace the disc.	19
	This message can also appear if condensation has formed. Wait until the camcorder dries completely before resuming use.	71
	The disc's recording surface may be dirty or scratched.	–
REACHED THE MAXIMUM NUMBER OF SCENES	The maximum number of scenes has been reached. Delete some recordings (DVD-RW in VR mode) to free some space or replace the disc.	19 52
CANNOT PLAY DISC	The disc is dirty or you attempted to play back a disc type not supported (not DVD-R/RW).	–
	This message can also appear if condensation has formed. Wait until the camcorder dries completely before resuming use.	71
CANNOT DIVIDE THE SCENE	You may not be able to further divide scenes shorter than 5 seconds that were created by dividing a previous scene.	–
	There is a problem with the disc.	–
PLEASE USE ONLY THE RECOMMENDED DISCS	The dual-layered disc you inserted cannot be used with this camcorder.	4
DISC IS FINALIZED CANNOT RECORD	You cannot record additional scenes on a finalized DVD-R/ DVD-R DL disc.	–
	You cannot record additional scenes or unfinalize a DVD-RW disc in VIDEO mode that was finalized with another digital device.	–
UNFINALIZE THE DISC	You cannot record additional scenes or convert still images to a Photomovie scene on a finalized DVD-RW in VIDEO mode. Unfinalize the disc first.	60
DISC IS PROTECTED	The disc is protected. Replace the disc or remove the disc protection.	54

Message	Explanation	
CANNOT READ THE DISC CHECK THE DISC	Disc could not be read. Try cleaning it or replace the disc.	70
	This message can also appear if the camcorder has exceeded its operational temperature. Turn off the camcorder and let it cool down before resuming use.	–
	This message can also appear if condensation has formed. Wait until the camcorder dries completely before resuming use.	71
	The disc may not be loaded correctly. Try removing the disc and reinserting it.	19
• ACCESS ERROR • DISC ACCESS FAILURE CHECK THE DISC	There was an error when reading the disc or attempting to write onto it. Try cleaning the disc or replace it.	70
	This message can also appear if condensation has formed. Wait until the camcorder dries completely before resuming use.	71
	The disc may not be loaded correctly. Try removing the disc and reinserting it.	19
DISC COVER IS OPEN	Verify the disc is correctly inserted and close the disc cover.	19
NO DISC	No disc is loaded. Insert a disc.	19
	This message can also appear if condensation has formed. Wait until the camcorder dries completely before resuming use.	71
LOADING THE DISC	The disc is being read. Wait before you start recording.	–
AVOID MOVING THE CAMCORDER	Try not to move the camcorder while the image is being recorded.	–
UNABLE TO RECOVER DATA	Could not recover a corrupted file.	–
	This message can also appear if condensation has formed. If you suspect condensation is the reason, do not initialize the disc and wait until the camcorder dries completely before resuming use.	71
DISC FULL	The disc is full (“END” flashes on the screen). Delete some recordings (DVD-RW in VR mode) to free some space or replace the disc.	19 52
TASK IN PROGRESS DO NOT DISCONNECT THE POWER SOURCE	The camcorder is updating important file allocation data on the disc. Do not disconnect the compact power adapter or remove the battery pack.	–
NO IMAGES	No images are recorded on the disc.	–
THE CAMCORDER IS SET TO STILL IMAGE MODE	You pressed the Start/Stop button while recording still images (CAMERA mode).	–
NAMING ERROR	The folder and file numbers have reached their maximum value. Set the [FILE NOS.] option to [RESET] and initialize the disc, erase all the images on the disc (DVD-RW in VR mode) or replace the disc.	–

Handling Precautions

Camcorder

- Do not subject the camcorder to vibrations or strong impacts while the DISC access indicator is on or flashing. The data may not be correctly recorded on the disc, and the recording may be permanently lost.
- Do not touch the pick up lens.
- Do not carry the camcorder by the LCD panel or the disc cover. Be careful when closing the LCD panel.
- Do not leave the camcorder in places subject to high temperatures (like the inside of a car under direct sunlight), or high humidity.
- Do not use the camcorder near strong electric or magnetic fields such as above TVs, near plasma TVs or mobile phones.
- Do not point the lens or viewfinder at strong light sources. Do not leave the camcorder pointed at a bright subject.
- Do not use or store the camcorder in dusty or sandy places. The camcorder is not waterproof – avoid also water, mud or salt. If any of the above should get into the camcorder it may damage the camcorder and/or the lens. Be sure to close the disc compartment cover after use.
- Be careful of heat generated by lighting equipment.
- Do not disassemble the camcorder. If the camcorder does not function properly, consult qualified service personnel.
- Handle the camcorder with care. Do not subject the camcorder to shocks or vibration as this may cause damage.

Battery Pack

DANGER!

Treat the battery pack with care.

- Keep it away from fire (or it might explode).
- Do not expose the battery pack to temperature higher than 60 °C. Do not leave it near a heater or inside a car in hot weather.
- Do not try to disassemble or modify it.
- Do not drop or knock it.
- Do not get it wet.

- Charged battery packs continue to discharge naturally. Therefore, charge them on the day of use, or the day before, to ensure a full charge.
- Contact of the battery terminals with metallic objects may cause a short circuit and damage the battery pack.
- Dirty terminals may cause a poor contact between the battery pack and the camcorder. Wipe the terminals with a soft cloth.
- Since storing a charged battery pack for a long time (about 1 year) can shorten its lifecycle or affect performance, we recommend to discharge the battery pack fully and to store it in a dry place at temperatures no higher than 30 °C. If you do not use the battery pack for long periods, charge and discharge it fully at least once a year. If you have more than one battery pack, perform these precautions at the same time for all battery packs.
- Although the battery pack's operating temperature range is from 0 °C to 40 °C, the optimal range is from 10 °C to 30 °C. At cold temperatures, performance will temporarily decline. Warm it in your pocket before use.
- Replace the battery pack if the usable time after full charge diminishes substantially at normal temperatures.

Mini DVD Disc

The recording surface of DVD discs is extremely delicate. If handled or stored in an incorrect manner, the camcorder may stop recognizing or may not be able to play back the disc. Be sure to observe the following precautions when storing/handling your discs.

● **Always remove the disc from the camcorder after you finish recording.**

- Do not store the camcorder with a disc left inside.
- Keep the disc clean of dust, dirt or smudges. Even very small smudges or particles of dust can lead to problems when recording or playing back the disc. Carefully inspect the recording surface of the disc before inserting it in the camcorder. If the disc gets dirty use a dry, soft lens-cleaning cloth to remove any fingerprints, dirt buildup or smudges from the disc surface. Clean the disc in a radial motion from its center outwards.
- Never use a chemically treated cloth or flammable solvents such as paint thinner to clean the disc.
- Do not bend, scratch or wet the disc and do not subject it to strong shocks.
- Do not attach any labels or stickers on the disc surfaces. The disc may not rotate in a stable manner and this may cause malfunctions.
- To protect the disc, return it to its case for storage.
- When writing on the label side of the disc, avoid hard tip pens. Use waterproof soft-tipped felt pens instead.
- Moving a disc rapidly between hot and cold temperatures may cause condensation to form on its surfaces. If condensation forms on the disc, put it aside until the water droplets have evaporated completely.

- Never expose the disc to direct sunlight and do not store it in places subject to high temperatures or high humidity.
- Always finalize a disc before inserting it into an external DVD device. Failing to do so can result in the loss of the recorded data.

Built-in Rechargeable Lithium Battery

The camcorder has a built-in rechargeable lithium battery to keep the date/time and other settings. The built-in lithium battery is recharged while you use the camcorder, however, it will become totally discharged if you do not use the camcorder for about 3 months.

To recharge the built-in lithium battery:

Connect the compact power adapter to the camcorder and leave it connected for 24 hours with the power switch set to **OFF**.

Maintenance/Others

Storage

- If you do not intend to use the camcorder for a long time, store it in a place free of dust, in low humidity, and at temperatures not higher than 30 °C.

Cleaning

Camcorder Body

- Use a soft, dry cloth to clean the camcorder body. Never use chemically treated cloth or volatile solvents such as paint thinner.

Pick Up Lens

- Remove any dust or dirt particles using a non-aerosol type blower brush. Never touch the pick up lens directly to clean it.

Lens and Viewfinder

- If the lens surface is dirty, the autofocus may not work properly.
- Remove any dust or dirt particles using a non-aerosol type blower brush.
- Use a clean, soft lens-cleaning cloth to gently wipe the lens or viewfinder. Never use tissue paper.

LCD Screen

- Clean the LCD screen using a clean, soft lens-cleaning cloth.
- Condensation may form on the surface of the screen when the temperature changes suddenly. Wipe it with a soft dry cloth.

Condensation

Moving the camcorder rapidly between hot and cold temperatures may cause condensation (water droplets) to form on its internal surfaces. Stop using the camcorder if condensation is detected. Continued use may damage the camcorder.

Condensation may form in the following cases:

When the camcorder is moved from an air-conditioned room to a warm, humid place

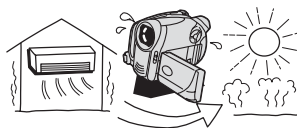

When the camcorder is moved from a cold place to a warm room

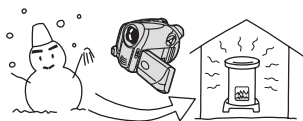

When the camcorder is left in a humid room

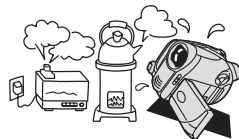

When a cold room is heated rapidly

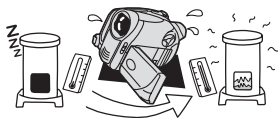

TO AVOID CONDENSATION

- Do not expose the camcorder to sudden or extreme changes in temperature.
- Unload the disc, place the camcorder in an airtight plastic bag and let it adjust to temperature changes slowly before removing it from the bag.

WHEN CONDENSATION IS DETECTED

- The camcorder automatically shuts off. If a disc is loaded, remove the disc immediately and leave the disc cover open. Leaving the disc in the camcorder may damage it.
- A disc cannot be loaded when condensation is detected.

RESUMING USE

- The precise time required for water droplets to evaporate will vary depending on the location and weather conditions. As a general rule, wait for 2 hours before resuming use of the camcorder.

Using the Camcorder Abroad**Power Sources**

You can use the compact power adapter to operate the camcorder and to charge battery packs in any country with power supply between 100 and 240 V AC, 50/60 Hz. Consult the Canon Service Center for information on plug adapters for overseas use.

Playback on a TV Screen

You can only play back your recordings on TVs compatible with the PAL system. The PAL system is used in the following countries/areas:

Algeria, Australia, Austria, Bangladesh, Belgium, Brunei, China, Croatia, Czech Republic, Denmark, Finland, Germany, Hong Kong Special Administrative Region, Iceland, India, Indonesia, Iraq, Iran, Ireland, Israel, Italy, Jordan, Kenya, Kuwait, Liberia, Malaysia, Malta, Montenegro, Mozambique, the Netherlands, New Zealand, North Korea, Norway, Oman, Pakistan, Poland, Portugal, Qatar, Romania, Serbia, Sierra Leone, Singapore, Slovakia, Slovenia, South Africa, Spain, Sri Lanka, Swaziland, Sweden, Switzerland, Tanzania, Thailand, Turkey, Uganda, Ukraine, United Arab Emirates, United Kingdom, Yemen, Zambia.

System Diagram (Availability differs from area to area)

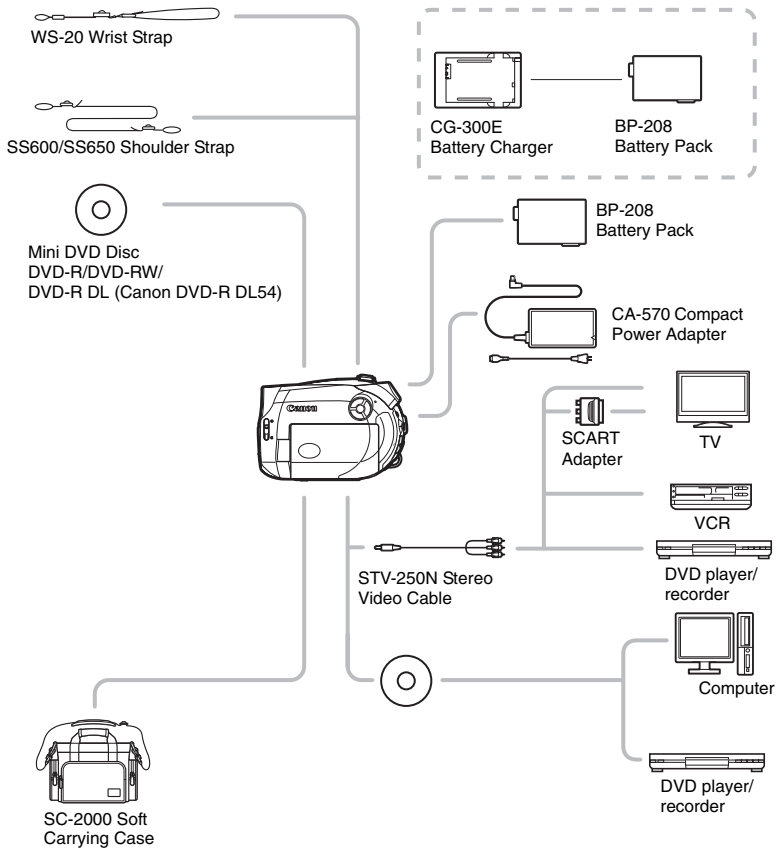

Optional Accessories

Use of genuine Canon accessories is recommended.

This product is designed to achieve excellent performance when used with genuine Canon accessories. Canon shall not be liable for any damage to this product and/or accidents such as fire, etc., caused by the malfunction of non-genuine Canon accessories (e.g., a leakage and/or explosion of a battery pack). Please note that this warranty does not apply to repairs arising out of the malfunction of non-genuine Canon accessories, although you may request such repairs on a chargeable basis.

Battery Packs

When you need extra battery packs, select only the BP-208 battery pack.

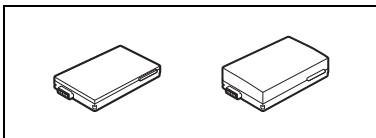

CG-300E Battery Charger

Use the battery charger for charging the battery packs.

Charging time: 105 min. The charging time varies according to the initial charging conditions.

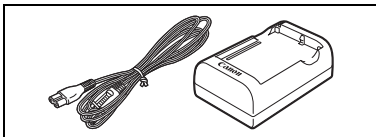

Shoulder Strap

You can attach a shoulder strap for more security and portability.

Pass the ends through the strap mount and adjust the length of the strap.

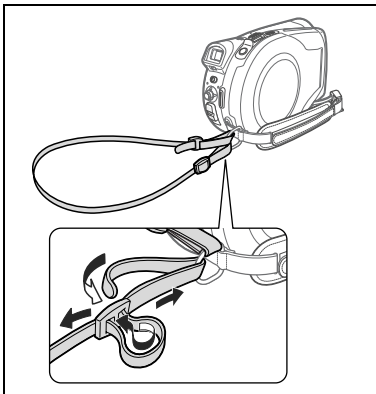

WS-20 Wrist Strap

Use this for extra additional protection for active shooting.

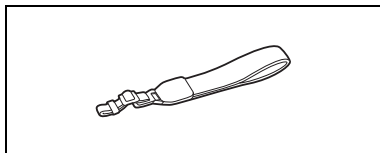
**SC-2000 Soft Carrying Case**

A handy camcorder bag with padded compartments and plenty of space for accessories.



This mark identifies genuine Canon video accessories. When you use Canon video equipment, we recommend Canon-brand accessories or products bearing the same mark.



Specifications

DC201/DC210/DC211

System		
Disc Recording System	Movies	DVD-VIDEO (VIDEO mode) DVD-VR (VR mode) only with 8 cm DVD-RW Video Compression: MPEG2 Audio Compression: Dolby Digital 2ch
	Still Images	Exif 2.2** compliant with JPEG compression
Television System	CCIR standard (625 lines, 50 fields) PAL color signal	
Compatible Media	8 cm mini DVD discs marked with the DVD-R, DVD-R DL or DVD-RW logo 	
Maximum Recording Time	1.4 GB single sided 8 cm mini DVD disc: XP: approx. 20 min., SP: approx. 30 min., LP: approx. 60 min. 2.6 GB single sided dual-layered 8 cm mini DVD disc: XP: approx. 36 min., SP: approx. 54 min., LP: approx. 108 min.	
Image Sensor	1/6-inch CCD, approx. 800,000 pixels Effective pixels 16:9 Movies (Image stabilizer [ON]) approx. 440,000 pixels 16:9 Movies (Image stabilizer [OFF]) approx. 540,000 pixels 4:3 Movies approx. 400,000 pixels Still images approx. 530,000 pixels	
LCD Screen	2.7 in., wide, TFT color, approx. 123,000 pixels	
Viewfinder	0.27 in., wide, TFT color, approx. 123,000 pixels	
Microphone	Stereo electret condenser microphone	
Lens	(DC210/DC211) f=2.6-91 mm, F/2.0-5.0, 35x power zoom 35 mm equivalent: 16:9 Movies (Image stabilizer [ON]) 45.3 - 1,586 mm 16:9 Movies (Image stabilizer [OFF]) 40.8 - 1,428 mm 4:3 Movies 49.8 - 1,743 mm Still images 43.6 - 1,526 mm (DC201) f=2.6-78 mm, F/2.0-4.4, 30x power zoom 35 mm equivalent: 16:9 Movies (Image stabilizer [ON]) 45.3 - 1,359 mm 16:9 Movies (Image stabilizer [OFF]) 40.8 - 1,224 mm 4:3 Movies 49.8 - 1,494 mm Still images 43.6 - 1,308 mm	
Lens Configuration	10 elements in 8 groups (1 double-sided aspheric element)	
AF system	TTL autofocus, manual focusing possible	
Minimum Focusing Distance	1 m; 1 cm on maximum wide angle	
White Balance	Auto white balance, custom white balance and preset white balance settings: DAYLIGHT, TUNGSTEN	
Minimum Illumination	1.1 lx ([NIGHT] recording program, Shutter speed at 1/6) 4.5 lx (Auto mode, Auto slow shutter [ON], Shutter speed at 1/25)	
Recommended Illumination	More than 100 lx	
Image Stabilization	Electronic	
Size of Still Images	1024 x 768, 640 x 480 pixels	
Image Compression Method	JPEG (compression: Super Fine, Fine, Normal)	

Output Terminals

AV Terminal	Ø 3.5 mm minijack Video: 1 Vp-p / 75 ohms unbalanced Audio: -10 dBV (47 kohm load) / 3 kohm or less
--------------------	-----------------------------------------------------------------------------------------------------------

Power/Others

Power supply (rated)	7.4 V DC (battery pack), 8.4 V DC (compact power adapter)
Power consumption (SP mode, AF on)	2.9 W (viewfinder), 3.0 W (LCD screen [NORMAL])
Operating temperature	0 - 40 °C
Dimensions (W x H x D)	54 x 90 x 128 mm excluding the grip belt
Weight (camcorder body only)	400 g

CA-570 Compact Power Adapter

Power supply	100 - 240 V AC, 50/60 Hz
Rated output / consumption	8.4 V DC, 1.5 A / 29 VA (100 V) - 39 VA (240 V)
Operating temperature	0 - 40 °C
Dimensions	52 x 29 x 90 mm
Weight	135 g

BP-208 Battery Pack

Battery type	Rechargeable Lithium Ion Battery
Rated voltage	7.4 V DC
Operating temperature	0 - 40 °C
Battery capacity	850 mAh
Dimensions	39 x 8 x 63 mm
Weight	40 g

Weight and dimensions are approximate. Errors and omissions excepted. Subject to change without notice.

Index

16:9 aspect ratio	26
9 Point AiAF (Autofocus)	47

A

Abroad, using the camcorder	72
Auto (recording program)	40
Auto slow shutter	34
Autofocus (AF)	47
AV terminal	61

B

Battery pack, charging	17
Battery pack, remaining charge	15
Beach (recording program)	40
Beep	38
Built-in backup battery	70

C

Center point (Autofocus)	47
Compact power adapter	17
Condensation	71
Connection to a TV/VCR	61

D

Data code	48
Date and time	24
Daylight saving time	23
Digital effects	49
Digital zoom	35
Disc title	55
Disc types (DVD-R, DVD-R DL, DVD-RW)	3

E

Erasing still images	56
Error messages	67

F

File numbers	38
Finalizing the disc	58
Fireworks (recording program)	40
Focus priority	35
FUNC. menu	22, 33

G

Grip belt	20
-----------	----

I

Image effects	45
Image jump	31
Image stabilizer	35
Index screen - Movies	29
Index screen - Still images	31
Initialization - Disc	54

J

Joystick	9
Joystick guide	9

L

Language	23
LCD backlight	21
LCD screen	21
LP mode	33

M

Magnifying a still image	32
Maintenance	71
Manual exposure adjustment	43
Manual focus	43
Mode switch	40

N

Night (recording program)	40
Normal TV (4:3)	38

O

Original recordings	51
---------------------	----

P

P (recording program)	41
Photomovie scene	57
Playback - Movies	29
Playback - Still images	30
Playlist	51
Portrait (recording program)	40
Power save	38
Protecting the disc	54

Q
 Quick Start function 28

R
 Recommended discs 4
 Recording - Movies 25
 Recording - Still images 27
 Recording data 48
 Recording mode 33
 Recording programs 40
 Recording reminder 15
 RESET 63
 Reviewing - Movies (Record review) . . . 26

S
 Scene editing 51
 Screen displays 14
 Screen markers 37
 Selecting the on-screen displays 48
 Self timer 49
 Serial number 12
 Setup menus 22, 34
 Shoulder strap 74
 Slideshow 31
 Snow (recording program) 40
 SP mode 33
 Sports (recording program) 40
 Spotlight (recording program) 40
 Still image quality 46
 Still image size 46
 Sunset (recording program) 40

T
 Telephoto 28
 Time zone 23
 Tripod 26
 Troubleshooting 63
 Tv (recording program) 41

V
 VIDEO mode (disc specification) 3
 Viewfinder, dioptic adjustment 20
 Volume 30
 VR mode (disc specification) 3

W
 White balance 44
 Wide angle 28
 Wide TV (16:9) 38
 Widescreen 26
 Wind screen 36

X
 XP mode 33

Z
 Zoom 28
 Zoom speed 35



CANON INC.

Canon Europa N.V.

P.O. Box 2262, 1180 EG Amstelveen, the Netherlands

Canon UK Ltd.

CCI Service Centre, Unit 130

Centennial Park, Borehamwood, Hertfordshire, WD6 3SE, England

Telephone 0870-241-2161

Canon Australia Pty. Ltd.

Info-Line: 131383

www.canon.com.au

Canon New Zealand Ltd.

Customer Care: (09) 489 0470

www.canon.co.nz

Canon Singapore Pte. Ltd

1 HarbourFront Avenue, #04-01 Keppel Bay Tower, Singapore 098632

Tel: (65) 6799 8888

Fax: (65) 6799 8882

Canon Hongkong Company Ltd

19/F., The Metropolis Tower, 10 Metropolis Drive, Hunghom, Kowloon, Hong Kong

Canon Latin America, Inc.

Sales & Enquiries: 703 Waterford Way Suite 400 Miami, FL 33126 USA

The information on this manual is verified as of 1 January 2007.



Printed on 100% reused paper.

Free Manuals Download Website

<http://myh66.com>

<http://usermanuals.us>

<http://www.somanuals.com>

<http://www.4manuals.cc>

<http://www.manual-lib.com>

<http://www.404manual.com>

<http://www.luxmanual.com>

<http://aubethermostatmanual.com>

Golf course search by state

<http://golfingnear.com>

Email search by domain

<http://emailbydomain.com>

Auto manuals search

<http://auto.somanuals.com>

TV manuals search

<http://tv.somanuals.com>