

SUPERSEDED BY 19DG-355 7/76

Hermetic Centrifugal Liquid Chillers

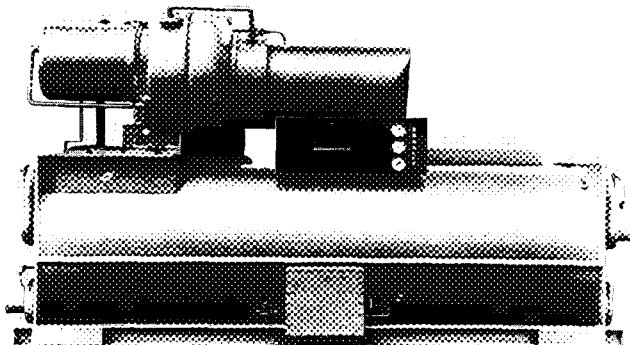

For Initial Start-Up Instructions, refer to pages 2 thru 7.

For Operation and Maintenance Instructions, refer to pages 8 thru 24.

CONTENTS

	Page		Page
BEFORE INITIAL START-UP	3- 5	Change Refrigerant Filter and Volute Drain Filter	10
Job Data Required	3	Compressor Bearing Maintenance	10
Equipment Required	3	Inspect Purge	10
Check Machine Tightness	3	Inspect Refrigerant Float Chamber	10
Inspect Piping	3	Inspect Unishell Tubes	11
Charge Refrigerant	4	Inspect Starting Equipment	11
Inspect Wiring	4	Ordering Replacement Parts	11
Check Starter	4	GENERAL MAINTENANCE	11-12
Oil Charge	4	Refrigerant Properties	11
Check Oil Heater	4	Charging Refrigerant	11
Check Safety Control Operation	5	Removing Refrigerant	11
Check Purge Operation	5	Trimming Refrigerant Charge	11
INITIAL START-UP	5- 7	Refrigerant Loss	11
Prepare Machine for Initial Start-Up	5	Air and Water Leaks	11
Initial Start-Up	5	Pressurizing the Machine	12
Set Safety Controls (Initial Start-Up)	6	Guide Vane Linkage	12
Check Operating Controls	6	TROUBLESHOOTING GUIDE	13-16
Check Machine Operating Condition	7	Compressor Will Not Start	13
Trim Refrigerant Charge	7	Compressor Trips Off	14
OPERATING INSTRUCTIONS	8- 9	Compressor Runs but Guide Vanes Will Not Open	15
Operator Duties	8	Chilled Water Temperatures Too High	15
Prepare Machine for Start-Up	8	Chilled Water Temperature Too Low	15
Start Machine	8	Chilled Water Temperature Fluctuates, Vanes Hunt	15
Check Running System	8	Oil Reservoir Temperature Too Low	16
To Stop Machine	8	Oil Reservoir Temperature Too High	16
After Limited Shutdown	8	Purge Does Not Operate in "Auto." Position	16
Extended Shutdown	8	Purge Cycles Often in "Auto." Position	16
After Extended Shutdown	8	Excessive Refrigerant Loss	16
Manual Operation	8	GENERAL DATA	17
Refrigeration Log	9	Machine Informative Plate	17
WEEKLY MAINTENANCE	9	System Components	17
Check Lubrication System	9	REFRIGERATION CYCLE	17
Check Purge Operation	9	MOTOR COOLING CYCLE	17
SCHEDULED MAINTENANCE	9-11	LUBRICATION CYCLE	18
Inspect Control Center	9	Summary	18
Check Safety Controls	9	Details	18
Change Oil and Oil Filter	10	PURGE CYCLE	18-20
		Purge Operation	20
		CONTROLS	21-23
		General	21
		Description	21
		Program Timer	21
		Oil Heater and Thermostat	21
		Machine Control Wiring	21
		Typical Control Sequence - Machine Start	21
		Typical Control Sequence - Machine Stop	23
		Typical Control Sequence - Machine Recycle	23
		CONTROL OPTIONS	23-24
		General	23
		Remote Thermostat	23
		Lead-Lag Control	23
		Safety Indicator Panel	24
		Autostart Control	24
		INSTRUCTING THE OPERATOR	24

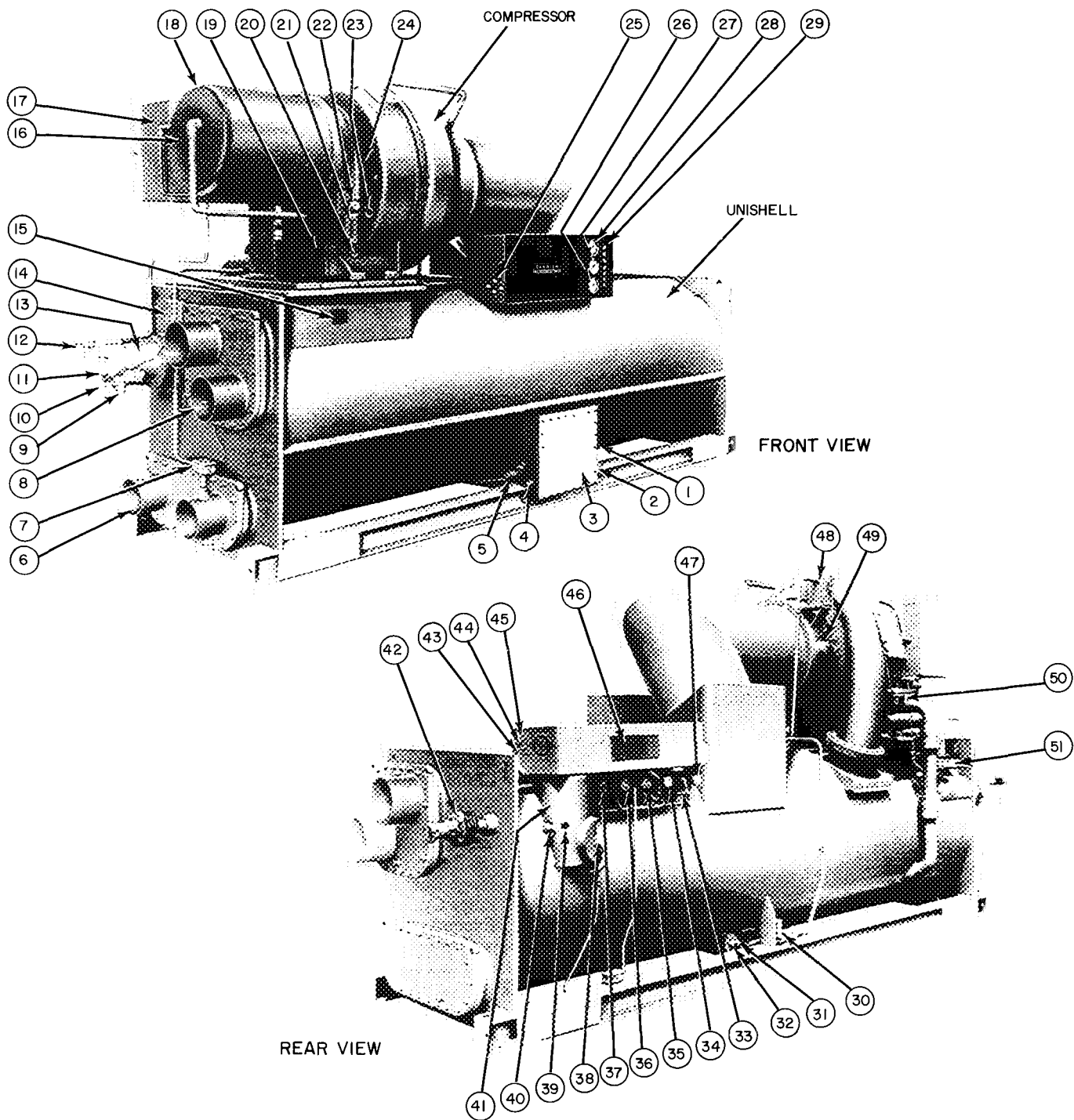

- 1 – Refrigerant Level Sight Glasses (Hidden)
- 2 – Refrigerant Agitator Solenoid Valve (Hidden)
- 3 – Float Valve Chamber
- 4 – Condenser Temperature Thermowell
- 5 – Cooler Charging Valve
- 6 – Cooler Water Nozzle
- 7 – Chilled Water Control Sensor
- 8 – Condenser Water Nozzle
- 9 – Oil Pressure Regulating Valve (Factory Set)
- 10 – Oil Charging Valve
- 11 – Oil Cooler Drain Plug (Hidden)
- 12 – Oil Cooler Solenoid Valve and Plug Valve
- 13 – Oil Pump and Oil Cooler-Filter Assembly
- 14 – Chilled Water Low-Temperature Cutout
- 15 – Machine Informative Plate
- 16 – Motor Rotation Sight Glass
- 17 – Compressor Terminal Box

LEGEND

- 18 – Motor End Bell
- 19 – Oil Heater and Thermostat Terminal Box
- 20 – Oil Reservoir Temperature Gage
- 21 – Oil Level Sight Glass
- 22 – Oil Reservoir Pressure Gage
- 23 – Return Oil Temperature Gage
- 24 – Compressor Nameplate
- 25 – Field Wiring Knockouts
- 26 – Cooler Pressure Gage
- 27 – Condenser Pressure Gage
- 28 – Oil Pump Pressure Gage
- 29 – Control Buttons and Lights
- 30 – Refrigerant Low-Temperature Cutout
- 31 – Low-Temperature Cutout Element
- 32 – Refrigerant Thermowell
- 33 – A-B Swing Connection
- 34 – Purge Valve 5

- 35 – Purge Valve 4
- 36 – Purge Valve 3
- 37 – Purge Valve 2
- 38 – Refrigerant Sight Glass
- 39 – Water Level Sight Glass
- 40 – Water Drain Valve
- 41 – Purge Condensing Chamber
- 42 – Safety Relief Device
- 43 – Purge Pump Switch
- 44 – Purge Pump Indicator Light
- 45 – Purge Solenoid Switch
- 46 – Purge Valve Operation Plate
- 47 – Purge Valve 6
- 48 – Guide Vane Actuator
- 49 – Vane Seal Oiler
- 50 – Inlet Volute Drain Filter
- 51 – Refrigerant Filter

Fig. 1 – Machine Components

BEFORE INITIAL START-UP

Job Data Required

1. List of applicable design temperatures and pressures.
2. Machine assembly, wiring and piping prints.
3. Starter details and wiring diagrams.
4. Prints and instructions for special controls.
5. 19DG Installation Instructions.

Equipment Required

1. Mechanic's tools
2. Volt-ohmmeter and clamp-on ammeter
3. Leak detector, electronic or halide
4. Absolute pressure manometer
5. Refrigerant drum charging valve
6. 5/8-in. SAE x 3/4-in. MPT adapter
7. Five to 10 ft of copper tubing or plastic hose to fit 5/8-in. SAE connections

Check Machine Tightness — 19DG machines are shipped under refrigerant-side vacuum. Over a period of time, during shipment or storage, part of this vacuum may be lost. To determine whether the vacuum loss, if any, is within Carrier's machine tightness standards:

1. Record and date vacuum reading shown on compressor-mounted oil reservoir pressure gage (item 22, Fig. 1).
2. Determine vacuum loss rate by comparing this reading with reading taken when machine was received. Use the formula:
$$\text{Vacuum loss rate} = \frac{\text{vacuum difference}}{\text{no. days between readings}}$$
3. If loss rate is 0.05 in. Hg or less per 24 hours, machine is sufficiently tight.
4. If loss rate exceeds 0.05 in. Hg per 24 hours, perform Refrigerant Pressure Test and correct leakage.
5. If vacuum loss is excessive or total, perform Vacuum Test. Results will indicate whether Refrigerant Pressure Test and Dehydration must be performed.

REFRIGERANT PRESSURE TEST

1. Pull a vacuum of 5.0 in. Hg ref 30 in. bar. (12.5 psia) using operation 2 on the purge valve operation plate (item 46, Fig. 1). An external vacuum pump attached to cooler charging valve (item 5, Fig. 1) may be used if desired.
2. Charge approximately one gallon of Refrigerant 11 thru the cooler charging valve. See Charge Refrigerant, page 4, for procedure.
3. Raise machine pressure to 8 – 10 psig with dry air or nitrogen. Procedure is described under Pressurizing the Machine, page 12. *Do not exceed 10 psig.*
4. Test all valves, joints, fittings, etc. with a halide or electronic leak detector.
5. Reduce machine pressure to near 0 psig; repair any leaks and then retest to ensure repair.

VACUUM TEST

1. Check machine for open valve or other connection. Correct before proceeding.

2. Install absolute pressure manometer at cooler charging valve. A dial gage cannot indicate the small amount of leakage acceptable.
3. Pull a vacuum of 25 in. Hg ref 30 in. bar. (2.5 psia). Use external vacuum pump or purge pump (see purge valve operation plate, item 46, Fig. 1).
4. Let machine stand with vacuum for 24 hours or more. Then check vacuum loss by formula above.
5. If loss rate is 0.05 in. Hg or less in 24 hours, machine is sufficiently tight. Perform Machine Dehydration.
6. If loss rate exceeds 0.05 in. Hg in 24 hours, make Refrigerant Pressure Test, repair leaks and then dehydrate machine.

MACHINE DEHYDRATION

The refrigerant side of the 19DG machine is dehydrated at the factory. If the machine has been open for a considerable period of time due to compressor removal, or if there has been excessive loss of shipping vacuum, dehydration should be repeated.

Dehydration is readily accomplished at normal or high room temperature. At low room temperature, special techniques must be employed; contact your Carrier representative.

Do not start compressor, oil pump or purge motor even for a rotation check, nor apply test voltage of any kind while machine is under dehydration vacuum. Motor insulation breakdown and serious damage can result.

1. Connect dehydration pump to cooler charging valve.
2. Close all valves on purge assembly. Valves are identified on purge valve operation plate.
3. Connect an absolute pressure manometer to the purge A-B connection (Fig. 9).
4. Operate dehydration pump until a vacuum of 29.80 in. Hg ref 30 in. bar. (0.1 psia) is reached. Continue to operate pump for 2 more hours.
5. Close cooler charging valve; stop dehydration pump; record manometer reading.
6. After a 2 hour wait, read manometer again. If vacuum has not decreased, dehydration is complete. If vacuum has decreased, repeat steps 4, 5 and 6.
7. If vacuum fails to hold after several dehydration attempts, check for a machine leak by repeating Refrigerant Pressure Test. After repairing leak, repeat vacuum test and dehydration.

Inspect Piping — Refer to piping diagrams provided in Job Data and inspect piping to cooler, condenser and oil cooler. Be sure that flow directions are correct and that all piping specifications are met.

Piping systems must be properly vented, with no stress on water box nozzles or covers.

Water flow thru cooler and condenser must meet job requirements. Measure pressure drop across cooler or condenser or across pumps.

Oil cooler water and piping must meet the specifications set forth in Job Data and in 19DG Installation Instructions. If city water is used, make sure that drainage is visible. Adjustment of plug valve (item 12, Fig. 1) to provide proper bearing temperature is made after compressor start.

Charge Refrigerant — Refrigerant supplied with the machine is more than that required for initial charging. *Charge only the amount shown on machine informative plate (item 15, Fig. 1).* Machine vacuum will draw refrigerant from drum.

After machine has been started, adjust charge as required for optimum machine performance. Refer to Trim Refrigerant Charge, page 7.

1. Connect short piece of plastic hose or copper tubing from refrigerant drum valve to cooler charging valve (item 5, Fig. 1).
2. Circulate chilled water during the charging process.
3. Charge refrigerant as a gas from the upright refrigerant drum until cooler vacuum becomes less than 18 in. Hg (6 psia).

At a vacuum of 18 in. Hg or greater, liquid Refrigerant 11 flashes into gas and can cause tube freeze-up and extensive damage.

4. Be sure that oil heater (item 19, Fig. 1) is energized during the charging process.

Inspect Wiring

WARNING: Do not check high voltage supply without proper equipment and precautions. Serious injury may result. Follow power company recommendations.

1. Examine wiring for conformance to job wiring diagrams and applicable electrical codes.
2. Check nameplates of oil pump, oil heater, purge unit and machine control panel for agreement with supply voltage, phase and Hertz.
3. Check motor nameplates of all auxiliary equipment, including brine and condenser water pumps and cooling tower pump and fan, for proper electrical supply.
4. Check motor starter ratings against motor voltage and amperage requirements. Motor overload relay selection must satisfy electrical code requirements.
5. Starter for centrifugal compressor motor must contain the components and terminals required for refrigeration machine control. Check job drawings.
6. Check that fused disconnects have been supplied for oil pump, oil heater, purge system, water pumps and fan motor.
7. Check that electrical equipment and controls are properly grounded in accordance with applicable electrical codes.
8. Be sure motors are properly lubricated and then momentarily energize each (except machine compressor motor) to determine direction of rotation. Correct as required.
9. Test machine compressor motor and its power lead insulation resistance with a 500-volt insulation tester such as a megohmmeter.

Do not apply test voltage of any kind while compressor is under dehydration vacuum.

- a. *Open starter main disconnect switch.*
- b. With tester connected to the motor side of the starter contactor in the starter, take 10-second and 60-second megohm readings as follows:

Six-lead motor — Tie all 6 terminals together and test between terminal group and ground. Next, tie terminals in pairs, 1 and 4, 2 and 5, 3 and 6. Test between each pair while grounding the third pair.

Three-lead motor — Tie terminals 1, 2 and 3 together and test between group and ground.

- c. Divide the 60-second resistance reading by the 10-second reading. The ratio (or polarization index) must be 1.15 to 1 or higher. Both the 10-second and 60-second reading must be at least 5.0 megohms. If the readings are unsatisfactory, repeat the test at the motor terminals with the power leads disconnected. Satisfactory readings in this second test indicate that the fault is in the power leads.

Check Starter — Open disconnect before checking.

1. Remove contactor arc chutes. Be sure that contactors move freely and that shipping string has been removed. Replace arc chutes.
2. Check contactors for dirt and rust. Clean contact magnet surfaces lightly with sandpaper. *Do not sandpaper or file silverplated contacts.* Apply a very thin coat of petroleum jelly to magnet surfaces and then wipe it off. If starter has been in a dusty atmosphere, vacuum clean cabinet and wipe with lint-free cloth.
3. Remove fluid cups from magnetic overload relays. Add dashpot oil to cups per instructions on relay nameplate. Oil is usually shipped in small vials attached to starter frame near relays. Use only dashpot oil supplied with starter. *Do not substitute.* Overload relays are factory set at 108% of motor full load amperage.
4. Check transfer timer for proper setting. On reduced voltage starters, timer has an adjustable range up to one minute and is factory set at 30 seconds.
5. With main disconnect open, manually open and close main control relay 1CR to be sure that it operates freely.

Oil Charge — The oil charge of approximately 15 gallons is shipped in the oil reservoir. Oil level should be visible at about ½ sight glass. If oil is added, it must meet Carrier specifications for hermetic centrifugal compressor usage.

Charge oil thru the oil reservoir charging valve (item 10, Fig. 1). With machine at vacuum, oil is drawn from the oil container. Continue charging until oil reaches middle of sight glass.

Checking Oil Heater — Energize the oil heater (item 19, Fig. 1) to minimize absorption of refrigerant by the oil. An indicator light goes on

when the oil heater is energized. The oil heater thermostat has been factory set to maintain 140 – 145 F temperature at machine shutdown. Adjust if required.

Check Safety Control Operation — As checks are made, control panel lights should appear as indicated.

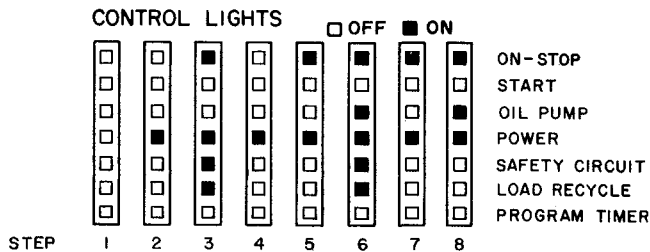

1. Open main disconnect (all power off to starter and controls). Then disconnect main motor leads in starter.
2. Provide control circuit power.
3. Press ON-STOP button (light goes on). If SAFETY CIRCUIT light does not go on, check resets on condenser high-pressure safety, low refrigerant safety, bearing and motor high-temperature circuit breakers and compressor overloads in starter. Check 3-amp fuse in control center.

If SAFETY CIRCUIT light goes on but LOAD RECYCLE light stays off, check the chilled water recycle switch (Auto.-Reset).

If both lights go on, manually trip and reset motor and bearing high-temperature circuit breakers, compressor motor overloads in starter, low-refrigerant temperature safety and condenser high-pressure safety. Tripping the chilled water recycle switch will cut off the LOAD RECYCLE light only.

4. Press ON-STOP button (light goes out). Remove and tag brown wire running between terminal 17 and 17 in control center.
5. Start chilled water and condenser water pumps. Press ON-STOP button (light goes on).
6. Press OIL PUMP button for several seconds. Pump should raise oil pressure to 20 – 25 psi differential between pump discharge gage on control panel and oil reservoir gage. SAFETY CIRCUIT and LOAD RECYCLE lights should go on.
7. Release OIL PUMP button. SAFETY CIRCUIT and LOAD RECYCLE lights should go out.
8. With OIL PUMP button depressed, alternately stop and restart chilled water and condenser water pumps. SAFETY CIRCUIT and LOAD RECYCLE lights should go out as each pump stops. (Continuous operation of oil pump is unnecessary.)

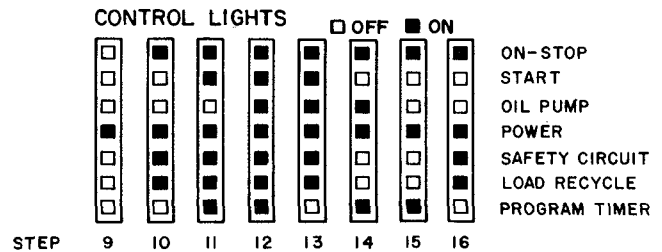

9. Shut off water pumps. Release OIL PUMP button. Press ON-STOP button (light goes out). Replace tagged wire on terminal 17.
10. Press ON-STOP button (light goes on).
11. Press machine START button (motor leads disconnected).
12. Oil pump starts within 30 seconds.
13. Compressor motor start contacts close 30 seconds later. Starter transfers to run condition 30 to 60 seconds after starter is energized.
14. Open oil pump disconnect. Compressor motor starter must de-energize. OIL PUMP light will remain on for about 30 seconds.
15. OIL PUMP light goes out.
16. Close oil pump disconnect. In approximately 15 minutes, the program timer will complete the antirecycle portion of its cycle and the machine is ready to restart.
17. Remove all power and then reconnect motor leads. Restore power.

Check Purge Operation — Place purge operating valves (Fig. 9) in “Normal-Automatic” position. Close purge disconnect and operate the purge pump momentarily by placing purge switch in “Manual” position. Then place purge switch again in “Normal-Automatic” position.

INITIAL START-UP

Prepare Machine for Initial Start-Up — Follow all steps described in Operating Instructions section under Prepare Machine for Start-Up, page 8.

Initial Start-Up — Before operating machine for any length of time, check compressor rotation and operation as follows:

COMPRESSOR ROTATION — Set capacity control switch (item 6, Fig. 2) at “Hold.” Press machine ON-STOP button and then START button. Compressor will start after start sequence has been completed (PROGRAM TIMER light goes out) and oil pump has operated for about 30 seconds (OIL PUMP light on). As soon as compressor motor begins to turn, press machine ON-STOP button (light goes out) and check for clockwise motor rotation as seen thru sight glass (item 16, Fig. 1) on motor end cover. If rotation is not clockwise, reverse any 2 of 3 power leads entering motor starter and recheck rotation.

COMPRESSOR OPERATION — Press machine ON-STOP button and then START button. Let compressor come up to speed. Note oil reservoir and oil pump gage pressures (items 22 and 28, Fig. 1). Differential should be 20 – 25 psi. Press machine ON-STOP button and listen for any unusual sounds from compressor as it coasts to a stop.

The program timer (item 4, Fig. 2) prevents rapid recycling of the compressor and allows restart 15 minutes after stop.

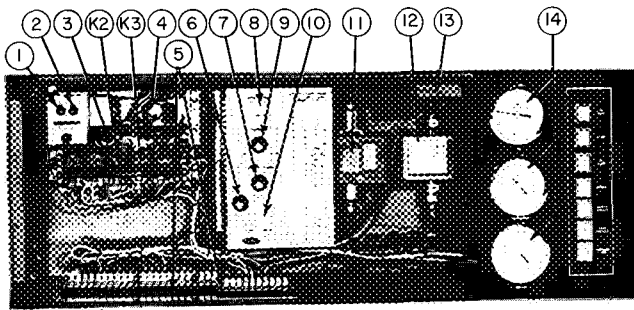

LEGEND

- 1 – Bearing High-Temperature Cutout (Manual Reset)
- 2 – Motor High-Temperature Cutout (Manual Reset)
- 3 – Relay Module
- 4 – Program Timer
- 5 – Terminal Strips for Field Connections
- 6 – Capacity Control Switch
- 7 – Electrical Demand Control
- 8 – Throttle Range Adjustment
- 9 – Chilled Water Thermostat
- 10 – Motor Current Calibration
- 11 – Low Oil Pressure Cutout
- 12 – Vane-Close Oil Pressure Switch
- 13 – Condenser High-Pressure Cutout (Manual Reset)
- 14 – Refrigerant and Oil Pressure Gages

Fig. 2 – Control Center

Set Safety Control (Initial Start-Up)

While performing these checks, carefully monitor chilled water temperature to prevent freeze-up. Protection by safety controls cannot be assumed until all control settings have been confirmed.

Open main disconnect (all power off to starter and controls). Set capacity control switch at “Hold.” Place clamp-on ammeter on one of the 3 starter leads. Install jumpers between terminals 40 and 43, and between 10 and 11 (per wiring label in control center).

Close disconnect(s), start compressor and check oil temperature and pressure (140 – 150 F and 20 – 25 psid). With compressor running, manually operate guide vanes with capacity control switch. *Do not exceed 100% of full load amperage.*

1. Set controls 1, 2 and 3 as indicated in Table 1.
2. Stop machine; open disconnect(s); remove jumpers and check settings of controls 4, 5 and 6 as indicated in Table 1.

Check Operating Controls – Check guide vane linkage and agitator valve action as described under Inspect Refrigerant Float Chamber, page 10, and Guide Vane Linkage, page 12.

CALIBRATE MOTOR CURRENT

1. Establish a steady motor current value for this calibration. Open guide vanes manually (capacity control at “Inc”) until full load current is reached. Motor current calibration (item 10, Fig. 2) may have to be turned counterclockwise to permit vanes to open as needed. *Do not exceed 105% of nameplate full load amperes.*

If full load current can be maintained for a period of time, calibrate at this condition. If

not, pull down to and maintain (capacity control at “Hold”) design leaving chilled water temperature, and calibrate at this condition.

2. Measure motor current at selected condition and determine its percentage of full load current.
3. Use this percentage to set the electrical demand control (item 7, Fig. 2) as follows:

PERCENT OF FULL LOAD MOTOR CURRENT	ELECTRICAL DEMAND ADJUSTMENT SETTING
105	100%
85 or above	80%
65 to 84	60%
45 to 64	40%
below 45	Control cannot be calibrated

4. Turn motor current calibration adjustment fully clockwise. Guide vanes will close part way.
5. Turn thermostat (item 9, Fig. 2) to “Cooler” (fully counterclockwise).
6. Set capacity control at “Inc” position.
7. Slowly turn motor current calibration counterclockwise. Allow the guide vanes to open until motor current reaches 5% above electrical demand setting.

NOTE: When adjusting motor current calibration, allow for a time lag of several seconds caused by feedback capacitance in the motor current circuit.

8. Check the foregoing motor current calibrations with machine under “Auto.” control as follows:
 - a. Close vanes manually (capacity control to “Dec”).
 - b. Turn capacity control to “Auto.” Vanes should stop opening at electrical demand setting.
9. If control was calibrated at less than 100% load, turn electrical demand control to 100%. Control is now automatically calibrated for 100% full load current.
10. If control cannot be calibrated with above procedure, check voltage signal from signal resistor in starter. At 100% full load current, voltage between terminals 23 and 24 inside control center must be 0.5 ± 0.1 volts. If not in this range, check sizing of resistor in starter.

Both excess motor current and chilled water temperatures below the thermostat set point will override the capacity control setting. If the capacity control knob is in the “Inc” position, the guide vanes will stop opening. At any other knob position, the vanes will close as needed.

The motor current limiting circuit operates in 2 steps.

At 100% full load motor current, the vanes will stop opening further. If the motor current should increase to 105% because of some change in load conditions, the vanes will close until the current is reduced to about 102%.

When the motor current drops to 98% or below, control again responds to chilled water temperature.

The electrical demand adjustment allows the operator to set the maximum current drawn by the motor and thus minimize the electrical demand rate during off-season operation.

CHILLED WATER TEMPERATURE CALIBRATION

1. Turn throttle range adjustment (item 8, Fig. 2) fully clockwise.
2. Adjust chilled water thermostat (item 7, Fig. 2) until design chilled water temperature is maintained. Mark this position on thermostat. If capacity control guide vanes "hunt," turn throttle range adjustment counterclockwise in

small steps until hunting ceases. Chilled water thermostat may require resetting.

Check Machine Operating Condition — Be sure that machine temperatures, pressures, water flow, oil and refrigerant levels indicate that the system is functioning normally. Refer to Check Running System, page 8.

Trim Refrigerant Charge — If it is necessary to adjust the refrigerant charge to obtain optimum machine performance, operate the machine at full load and add or remove refrigerant slowly until the difference between leaving chilled water temperature and the cooler refrigerant temperature reaches design conditions or becomes a minimum. Mark the shutdown refrigerant level near the float chamber sight glasses (item 1, Fig. 1).

Table 1 — Setting Safety Controls

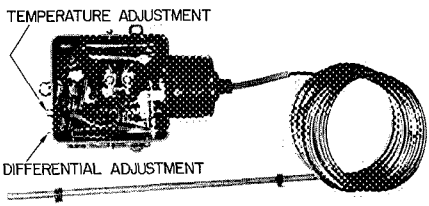
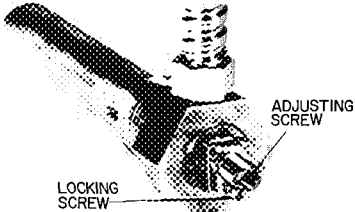
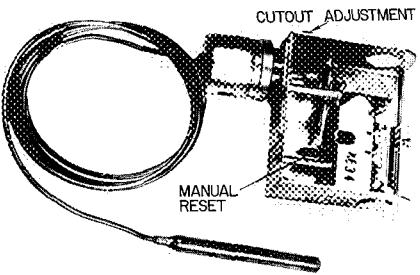
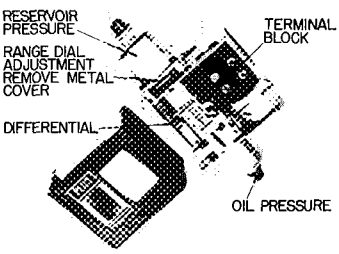
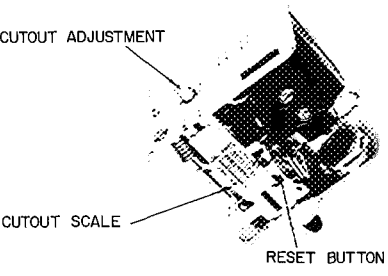
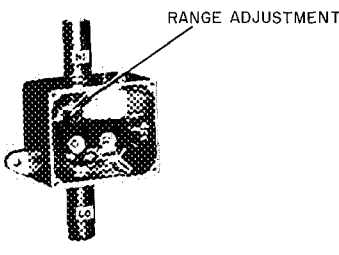
SAFETY OR CONTROL DEVICE	SAFETY OR CONTROL DEVICE
<p>1. Chilled Water Low-Temperature Cutout and Recycle Switch</p>  <p>a. Set switch to open at 5 F below design chilled water temperature, or at 36 F, whichever is higher.</p> <p>b. Set differential at $10 \pm 1^\circ\text{F}$ so that when machine shuts down at 5 F below the design chilled water temperature, it will re-start at 5 F above design water temperature.</p> <p>c. This control must break ahead of refrigerant low-temperature cutout switch or the machine will not recycle automatically.</p>	<p>STOP MACHINE, REMOVE JUMPERS AND CHECK CONTROLS 4, 5 AND 6.</p> <p>4. Oil Heater Thermostat</p>  <p>Set the oil heater thermostat to maintain a minimum oil reservoir temperature of 140 F at shutdown.</p>
<p>2. Refrigerant Low-Temperature Cutout</p>  <p>Set refrigerant low-temperature cutout at 33 F or 1°F below design refrigerant temperature, whichever is lower, while checking temperature at thermowell near switch.</p>	<p>5. Low Oil Pressure Cutout</p>  <p>Low oil differential pressure switch is factory set to open at 9.5 ± 1 psi and close at 14.5 ± 1 psi differential pressure. Confirm settings with a regulated supply of air.</p>
<p>3. Condenser High-Pressure Cutout</p>  <p>The condenser high-pressure cutout is factory set to shut machine down when condenser pressure reaches approximately .15 psig. Isolate the switch and check setting with a metered supply of air.</p>	<p>6. Vane-Close Oil Pressure Switch</p>  <p>Vane-close oil pressure switch is factory set to close at 18.5 (+1, -0) psi differential pressure (on rise), and open on a 0.5 psi drop in differential pressure. Switch does not require field calibration.</p>

OPERATING INSTRUCTIONS

Operator Duties

1. Become familiar with machine and accessories before operating equipment.
2. Prepare system for start-up; start and stop machine; place system in shutdown condition.
3. Maintain log of operating conditions.
4. Monitor and inspect equipment, and make routine adjustments.
5. Protect equipment from damage during shutdown.

Prepare Machine for Start-Up — Before starting machine, check that:

1. Power is on to main starter, oil pump starter, water pumps and tower fan, oil heater, purge pump and machine control circuit.
2. Cooling tower water is at proper level.
3. Machine is charged with refrigerant.
4. Oil is visible in reservoir sight glass.
5. Oil reservoir temperature is 140 – 150 F (with heater energized).
6. Oil cooler plug valve (item 12, Fig. 1) is partially open.
7. Valves in chilled water and condenser water circuits are open and water is circulating properly. *Do not run water of over 100 F thru cooler.*
8. Purge valves and switches are in “Normal-Automatic” position. (See chart, Fig. 12.)

Start Machine

1. Press ON-STOP button on control center (ON-STOP, SAFETY CIRCUIT and LOAD RECYCLE lights go on).
2. Press START button (light goes on).

Oil pump starts within ½ minute. If PROGRAM TIMER light is on, oil pump will start within 15 minutes. Compressor starts approximately 30 seconds after oil pump; program timer stops (light goes out).

Check Running System — After compressor starts, the operator should observe the following indications of normal operation.

Oil reservoir temperature	140 – 150 F
Bearing oil return temperature	150 – 175 F
Oil level	½ sight glass
Oil pressure	20 – 25 psi differential between pump discharge and oil reservoir
Oil cooler water	Visible at open drain
Condenser temperature	75 – 105 F (refer to selected design temp)
Cond lvg water temperature	Over 65 F
Cooler refig temperature	30 – 40 F (refer to selected design temp)
Purge pressure	Midway between cooler and condenser operating pressures

NOTE: The compressor may operate at full capacity for a short time during pulldown even though the building load is small. The electrical demand

control (item 7, Fig. 2) can be adjusted to avoid a high demand charge for the short period of full capacity operation.

To Stop Machine

1. Press ON-STOP button (ON-STOP, START, SAFETY CIRCUIT and LOAD RECYCLE lights go out; PROGRAM TIMER light goes on). Compressor motor de-energizes and begins to coast down.
2. Stop water pumps and tower fan, if not automatic.
3. Oil pump stops within 40 seconds.
4. Machine can be restarted 14 minutes after oil pump stops.

If machine fails to stop, close guide vanes manually by turning capacity control switch to “Dec” (decrease), and pull main circuit breaker. Do not attempt to stop machine by opening an isolating knife switch. DO NOT RESTART machine until malfunction has been corrected.

After Limited Shutdown — No special preparations should be necessary. Follow regular preliminary checks and starting procedures.

Extended Shutdown — Ordinarily, refrigerant charge may be kept in machine. If machine pressure cannot be kept below atmospheric, removal and storage of refrigerant is recommended. (See Removing Refrigerant, page 11.)

If freezing temperatures are liable to occur in machine area, drain chilled water, condenser water and oil cooler water circuits to avoid freeze-up. Clear oil cooler lines with air. Keep water box drains open.

If refrigerant is left in machine and water lines are not drained, check refrigerant level weekly. An increase in refrigerant level indicates a water leak. Locate and repair such leaks immediately.

Leave the oil charge in the machine with the oil heater (item 19, Fig. 1) energized to keep oil temperature at 140 – 145 F.

After Extended Shutdown — Close water box drains. If the refrigerant has been removed, recharge the machine as directed in Charging Refrigerant section. Observe freeze-up precautions while charging.

Carefully make all regular preliminary and running system checks. If compressor oil level appears abnormally high, oil may have absorbed refrigerant; raise oil thermostat setting (item 19, Fig. 1) to drive off any refrigerant.

Manual Operation — Manual control permits the operator to change the leaving chilled water temperature without altering the automatic temperature control settings. It is useful in checking control operation and safety cutout points, in overcooling the building prior to a heavy load, or in controlling the machine in an emergency.

Turn the capacity control switch (item 6, Fig. 2) to “Dec” (decrease) to close guide vanes and lower capacity.

“Hold” maintains guide vane position.

“Inc” (increase) opens guide vanes and increases capacity.

Refrigeration Log — The Carrier log sheet for 19D Series machines provides a convenient check list for routine maintenance and forms a continuing record of machine performance. It is an aid in scheduling maintenance and in diagnosing machine problems.

The log sheet is available from Carrier in pads of 50 each. When ordering, specify by form number E-56A, found at the lower left corner of the log sheet.

WEEKLY MAINTENANCE

Check Lubrication System — Mark oil level on reservoir sight glass (item 21, Fig. 1) and observe level each week while machine is shut down. Record date and amount of oil added. Added oil must meet Carrier specifications for centrifugal compressor usage.

To add oil while machine is under vacuum, attach a tube to the oil charging valve (item 10, Fig. 1) and place the other end in an oil container. Keep tube end submerged to prevent air from entering machine. With machine at vacuum, oil is drawn from the container. Charge until oil reaches middle of sight glass.

If machine pressure is above atmospheric, a small hand pump will be required for pumping the oil into the reservoir.

A 1000-watt oil heater and a thermostat maintain oil reservoir at 140 – 145 F. The heater pilot light should be on whenever the heater is on. If the pilot light is out and the reservoir is warm, check heater terminals with a voltmeter to determine if the contacts are closed. Replace bulb if necessary.

If the pilot light is out and the reservoir is colder than normal, the thermostat may be set too low, thermostat may be faulty or power may be off. Check power source, reset thermostat, replace thermostat if necessary.

Do not operate machine when oil temperature is less than 135 F.

The oil level in the vane seal oiler (item 49, Fig. 1) should be marked and the level checked each week. An appreciable drop in level may indicate an oil seal leak. A leaking seal must be replaced.

Check Purge Operation — Frequent operation of the purge pump (several times an hour) is an indication that air is entering the machine. Locate and repair any such leaks. For leak test procedures, see Check Machine Tightness.

If water is visible in the water level sight glass (item 39, Fig. 1) drain the water per operation 4 on the purge valve operation plate (item 46, Fig. 1). Measure and record the amount removed. If water is continually being removed, obtain the services of a Carrier representative to determine the source. If water is allowed to remain in the machine refrigerant side, serious damage will result.

SCHEDULED MAINTENANCE

Establish a regular maintenance schedule based on your actual machine conditions (machine load, hours of operation, water quality, etc.). The time intervals in this section are offered as guides.

Inspect Control Center — Maintenance is normally limited to general cleaning, tightening of connections and replacement of relays and modules. In the event of machine malfunction, refer to Troubleshooting Guide for control check and adjustment procedures.

Be sure power is off when making checks and adjustments inside control center.

Check Safety Controls — To ensure machine protection, the safety controls should be checked at least once during the operating season, or at least once every 6 months if machine is operated continuously. Control illustrations are shown in Table 1.

CHILLED WATER LOW-TEMPERATURE CUT-OUT AND RECYCLE SWITCH (item 14, Fig. 1)

1. Prepare machine for start-up; start machine.
2. Open guide vanes slowly (see Manual Operation) while observing thermometer in leaving chilled water line.
3. Cutout should stop machine at approximately 5 F below design chilled water temperature, or 36 F, whichever is higher.
4. Chilled water pump continues to run and chilled water temperature rises. Compressor should restart at 10 ± 1 F above the cutout temperature. Program timer must complete a 15 minute delay before machine can restart.
5. Adjust switch cutout point and differential (10 ± 1 F) range if required. Check machine operation after each adjustment. Switch must open before refrigerant low-temperature cutout in order to have automatic recycle.

REFRIGERANT LOW-TEMPERATURE CUTOUT (item 30, Fig. 1)

1. Jumper chilled water temperature cutout (terminal ⑩ to ⑪).
2. Start machine.
3. Open guide vanes manually while observing chilled water and refrigerant temperatures.
4. Cutout should shut off machine at 33 F, or at 1° F below design refrigerant temperature, whichever is lower.
5. Do not allow chilled water temperature to drop below 33 F. Refrigerant low-temperature switch should open before chilled water reaches 33 F.

LOW OIL PRESSURE CUTOUT (item 11, Fig. 2)

— Connect high-pressure side of switch (marked "HP") to a metered supply of air. Open low-pressure side to atmosphere. Quickly plug tube ends to prevent loss of machine vacuum. Switch should close on pressure rise at 14.5 ± 1 psi differential and open on pressure fall at 9.5 ± 1 psi differential.

CONDENSER HIGH-PRESSURE CUTOUT (item 13, Fig. 2) — Disconnect and quickly plug tube end. Test switch with metered air supply. Contacts should open at 15 ± 1 psig on pressure increase. Reset switch manually as pressure is reduced below 9 psig.

VANE-CLOSE OIL PRESSURE SWITCH (item 12, Fig. 2) – Disconnect and quickly plug tube ends. Connect high-pressure side of switch to metered air supply. Leave low-pressure side open to atmosphere. Contacts should close at about 18.5 psi differential on pressure rise. Contacts should open when pressure drops 0.5 psi below the closing pressure.

Change Oil and Oil Filter (see item 13, Fig. 1) yearly or if machine is opened for repairs.

To remove the oil, turn off the oil heater and raise machine pressure to approximately 5 psig with nitrogen or purge pump (see Pressurizing the Machine, page 12). Attach a tube to oil charging valve (item 10, Fig. 1) and drain the oil into a container. Drain the oil filter compartment thru the drain plug (item 11, Fig. 1).

With machine pressure at approximately 0 psig, remove lubrication package coverplate. Install a new filter cartridge. Cartridges can be obtained thru your nearest Carrier office. Remove any metallic particles from magnetic plug in coverplate.

Add new oil charge (approximately 15 gal.) thru oil charging valve, using a hand pump. Charge to approximately 1/3 sight glass.

Warm oil to 140 – 145 F with oil heater. Then run oil pump for 2 minutes by pressing OIL PUMP button on control center. Add oil if required to maintain original level.

Oil should be visible at reservoir sight glass under all operating and shutdown conditions. Use only high grade oil which conforms to the following specification:

Viscosity at 100 F, SSU	300 ± 25
Viscosity at 210 F, SSU	50 to 55
Viscosity index (min)	95
Pour point (max)	-5 F
Flash point (min)	400 F

Rust inhibiting characteristics: material shall pass ASTM Rust Test D665, latest revision. Use Procedure A with test period of 24 hours.

Oxidation resistance: material shall pass ASTM Oxidation Test D943, latest revision, for a minimum of 2000 hours. Acid number at end of test shall not exceed 2.0 mg, KOH per gram.

Change Refrigerant Filter and Volute Drain Filter (items 51 and 50, Fig. 1) – Each year, remove the steel bolt, lower the bottom half of the filter housing and replace filter cartridge. The cartridge (common to both filters) may be ordered thru the nearest Carrier office.

Compressor Bearing Maintenance – The best bearing maintenance consists of maintaining clean oil at proper temperature and pressure in the lubricating system.

With machine-side pressure at 0 psig, examine bearings on a scheduled basis for signs of wear. The frequency of examination is determined by the condition of the lubrication system, hours of

machine operation, type of load on the machine, etc.

The removal and examination of bearings should be done only by a trained service mechanic. Contact your nearest Carrier office for assistance.

Excessive bearing wear can sometimes be detected thru increased vibration or increased bearing temperature. If either of these symptoms appears, contact your nearest Carrier office for assistance by a Carrier service mechanic.

Inspect Purge – A purge in good repair protects the machine against corrosive mixtures and can prevent damage to major components.

1. Remove the cover of the purge refrigerant float chamber and thoroughly clean the chamber and float valve. Make sure that the valve operates freely thru its full travel.
2. Remove and examine the float valve plunger. Replace the plunger and seat assembly if there are signs of wear.
3. Reassemble components, using a new O-ring on chamber cover.
4. Check the 1/16-in. orifice in the purge sampling line (Fig. 9).
5. Replace the strainer element in the orifice-strainer assembly.

Yearly replacement of the purge pump inlet and outlet valves is recommended.

Inspect Refrigerant Float Chamber – With machine pressure at 0 psig, remove access cover and thoroughly clean chamber, mesh screen and float valve assembly.

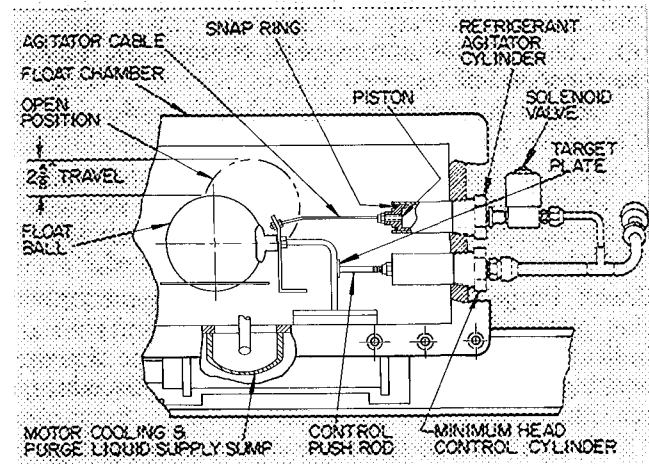

Fig. 3 – Refrigerant Float Chamber

If the float valve does not operate freely thru its full travel (Fig. 3), check damper blade assembly for binding. Replace the blade assembly if it binds. Since the float valve assembly is not a positive seating valve, contact between damper blade and deck plate need not be 100%.

The refrigerant agitator cable (Fig. 3) should be without slack when float valve is closed and agitator piston is against snap ring.

The minimum head control push rod (Fig. 3) should be in contact with the float valve target plate when the float valve is closed and the head control piston is against the snap ring.

Inspect Unishell Tubes

COOLER — Inspect and clean cooler tubes at end of first operating season. Tube condition at this time will establish the required frequency for cleaning and will indicate whether water treatment is needed in the chilled water circuit.

CONDENSER — Since this water circuit is usually an open system, the tubes may be subject to contamination by foreign matter and scale. Clean the condenser tubes at least once a year, and more often if the water is contaminated.

Higher than normal condenser pressures, together with inability to reach full refrigeration load, usually indicates dirty tubes, or air in the machine.

When the refrigeration log indicates a rise above normal condenser pressures, check the pressure against actual refrigerant condensing temperature as follows:

1. Install a thermometer in the condenser temperature thermowell (item 4, Fig. 1).
2. If the thermometer reading is more than 2 F below the temperature corresponding to the existing pressure (see condenser pressure gage), air is present in the machine.
3. Vent the air in spurts thru the condenser purging valve until condenser pressure is reduced to normal.
4. If, however, the thermometer reading and the temperature on the pressure gage correspond, the high condenser pressure is caused by dirty tubes or by abnormal conditions in the condensing water circuit such as restricted flow, etc.
5. Check operation of condensing water circuit. If water conditions (flow and temperature) appear normal, the tubes should be cleaned.

Tube cleaning brushes, specially designed to avoid scraping or scratching the tube walls, are available thru your Carrier office. *Do not use wire brushes.*

Hard scale may require chemical treatment for its prevention or removal. Consult a water treatment specialist for proper treatment.

Inspect Starting Equipment — Before working on any starter, shut off machine and open disconnect ahead of starter.

Isolating knife switches must not be opened while equipment is operating. Serious injury may result.

Inspect starter contact surfaces for wear or pitting. Do not sandpaper or file silverplated contacts. Follow starter manufacturer's instructions for contact replacement, lubrication and other maintenance requirements.

Ordering Replacement Parts — Order Carrier Specified Parts from your nearest Carrier office. The following information must accompany order:

1. Machine model number and serial number
2. Name, quantity and part number of part required.
3. Delivery address and method of shipment

GENERAL MAINTENANCE

Refrigerant Properties — At normal atmospheric pressure, Refrigerant 11 is a colorless liquid which boils at 74.8 F. The vapor is much heavier than air and will therefore remain in an open container with little loss by evaporation. Above 74.8 F, closed containers of Refrigerant 11 are under pressure and should be opened with care.

Refrigerant 11 is practically odorless and is nontoxic (except in open flame) and non-combustible. It will, however, dissolve natural rubbers and oil, dry the skin and in heavy concentrations *displaces oxygen and may cause asphyxiation*. When handling refrigerant, protect hands and eyes and avoid breathing fumes.

Charging Refrigerant — Follow the instructions in the section entitled Before Initial Start-Up, page 4.

Removing Refrigerant

1. Raise cooler pressure to 5 – 8 psig as described under Pressurizing the Machine, page 12.
2. Connect a length of plastic hose or copper tube to the refrigerant charging valve, and place the other end into a refrigerant container.
3. Open charging valve and allow refrigerant to flow into container.
4. Leave a space of about 3 in. above the liquid in the container to allow for refrigerant expansion. Above 75 F, Refrigerant 11 develops pressure in closed containers. Store containers in a cool place and exercise care in opening them.

Trimming Refrigerant Charge — Follow procedure given in Trim Refrigerant Charge, page 7.

Refrigerant Loss — Some refrigerant is discharged from the machine when the purge unit removes air and noncondensables. Any leak which causes frequent purge cycling should therefore be repaired without delay.

Air and Water Leaks — Air in the machine causes higher than normal condenser pressure, compressor surge at start-up and frequent purge cycling. Locate and repair any air leaks as soon as possible.

Higher than normal condenser pressure can also be caused by dirty tubes, high entering water temperature or lack of condensing water. To determine if air is the cause, check condenser and refrigerant temperatures as described under Inspect Unishell Tubes, on this page.

LEAK TESTING — Refrigerant can remain in the machine when leak testing. If the refrigerant is removed, charge approximately one gallon of Refrigerant 11 into machine before pressurizing.

Pressurize the machine as described below and then test all joints and flanges with a halide or electronic leak detector. Be sure room is free of concentrations of refrigerant when leak testing.

Water leaks during machine shutdown can be detected by a rise in refrigerant level. Water leaks during machine operation are indicated by frequent and excessive accumulation of water in the purge separation chamber. Water leaks should be repaired immediately by a Carrier Service mechanic.

Machine must be dehydrated after repair of water leaks. See Machine Dehydration, page 3.

Pressurizing the Machine — Whenever the machine vacuum must be broken for service work or for extended shutdown, nitrogen is recommended. Dry nitrogen is preferable to air as it does not introduce moisture into the machine. *Never use oxygen for pressurizing.*

To pressurize with nitrogen or dry air:

1. Connect copper tube from pressure cylinder to cooler charging valve. Never apply full cylinder pressure to the pressurizing line. Follow the steps below in proper sequence.
2. Open cooler charging valve fully.
3. Open cylinder regulating valve slowly.
4. Observe cooler pressure gage and close cylinder regulating valve when test pressure of 5 – 8 psig is reached.

Do not exceed 10 psig!

5. Close cooler charging valve. Remove copper tube if no longer required.

If nitrogen or bottled dry air are not readily available, the machine purge pump may be used for pressurizing with air as follows:

1. If possible, raise machine pressure by raising chilled water temperature. This will minimize the amount of air admitted into the system.
2. Disconnect purge connection A (Fig. 9) and admit air until machine pressure reaches atmospheric (0 psig).
3. Drain any water from purge condensing chamber thru valve 1 (Fig. 9).
4. Pressurize machine per Operation 3 on purge valve chart (Fig. 12).
5. Stop purge pump when machine pressure reaches 5 – 8 psig. *Do not exceed 10 psig.*

To return the machine to normal operating pressure, follow Operation 2 on the purge valve chart.

TESTING AT HIGHER PRESSURE — If leaks are undetected at normal test pressure (5 – 8 psig), tests may be made at a maximum of 15 psig with the following provisions.

1. Equalize rupture disc pressure (see Fig. 4).
2. Pressurize machine to 15 psig maximum.

3. Perform leak test.
4. After pressure has been reduced to normal, remove equalizing line and provide full 2-in. passage to rupture disc.

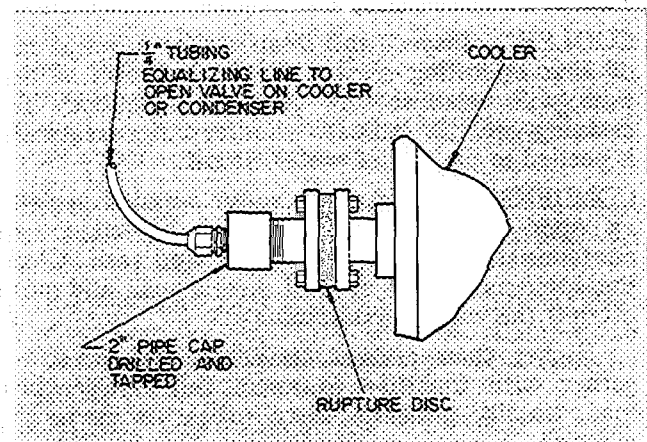

Fig. 4 — Equalizing Rupture Disc Pressure

Guide Vane Linkage — 19DG guide vane and linkage assembly is carefully adjusted and set at factory.

When the machine is off, the guide vanes are closed and the vane actuator is stopped by a limit switch at the Fig. 5 position.

If the motor crankarm is in proper position at machine shutdown but the vane crankarm is not, the guide vanes are not fully closed. Loosen the vane crankarm linkage connector, close the vanes tightly by hand and reconnect the linkage.

If the motor crankarm is not in the proper position, test relay K2 by substituting relay K3 (Fig. 2). If the arm fails to move, loosen setscrews and examine shaft for slippage marks. If none are apparent, actuator switches or windings are defective; replace actuator.

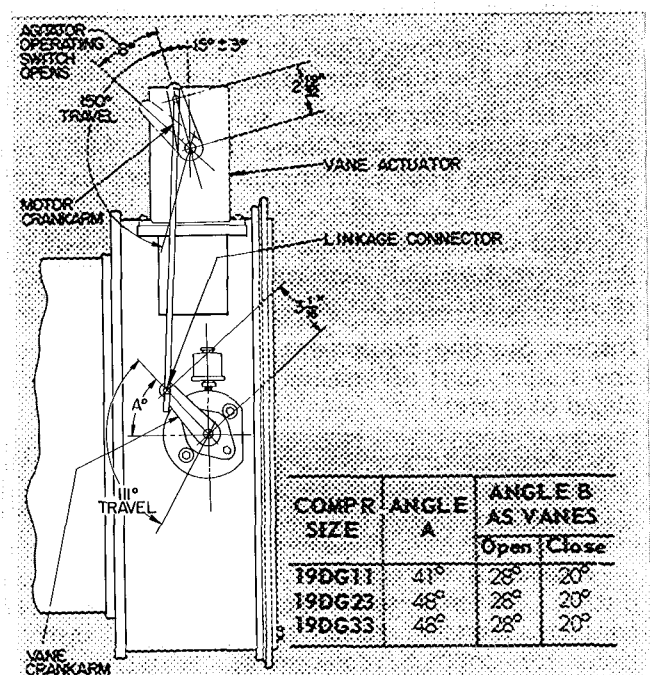

Fig. 5 — Guide Vane Linkage (Closed Position)

TROUBLESHOOTING GUIDE

TROUBLE/SYMPTOM	PROBABLE CAUSE	REMEDY	
COMPRESSOR WILL NOT START. All panel lights out.	No control power.	Check for building power failure. Check main circuit breaker.	
	Blown fuse.	Check 15-amp fuse in control circuit; examine circuit for ground or short.	
	Panel lights as shown; SAFETY CIRCUIT light does not come on.	Bearing or motor winding circuit breaker (CB1 or CB2) tripped.	Check CB1. If open, reset. Check relay KB by replacing it with relay KM. Check CB2. If open, reset. Check relay KM by replacing it with relay KB. <i>If compressor trips out, check immediately for high bearing or motor temperatures. If present, DO NOT RE-START without proper corrective action.</i>
		Cooler low-temperature or condenser high-pressure switch tripped.	Reset switch manually.
		Blown fuse.	Check 3-amp fuse in control circuit; examine circuit for ground or short.
		Compressor motor overloads tripped.	Reset overloads in starter.
Oil temperature too low.		Check oil heater and oil low-temperature switch.	
Time-delay relay K4 open.	Remove control power and check continuity between $\textcircled{17}$ and $\textcircled{14}$; if open, check K4 relay.		
Panel lights as shown; LOAD RECYCLE light does not come on.	Chilled water temperature too low.	Check water temperature.	
	Chilled water low-temperature switch incorrectly set.	Check setting of switch.	
* PROGRAM TIMER light goes on momentarily, then out.	1CR normally closed contact open.	Check for 120 volts between $\textcircled{15}$ and $\textcircled{L2}$.	
● OIL PUMP light goes on 10 to 30 seconds after pushing START button; goes out after about one minute. START light stays on.	Oil pump not operating (check by pressing OIL PUMP button).	Push ON-STOP button (light out) and then check for open oil pump disconnect. Check for faulty pump wiring. Check for faulty oil pump.	
	Oil pump operates but oil pressure low.	Check oil level. Check for dirty oil filters; replace. Check oil pressure regulating valve.	
	Oil low-pressure switch open (oil pressure normal).	Check setting of oil low-pressure switch. Check that both sets of contacts close when oil pressure is normal.	
	Vanes-closed switch open.	Check continuity between $\textcircled{V1}$ and $\textcircled{V2}$; if none, check guide vane adjustment linkage per Fig. 5. If actuator is not in fully closed position, check relay K2 by replacing it with K3.	

- ON-STOP
- START
- OIL PUMP
- POWER
- SAFETY CIRCUIT
- LOAD RECYCLE
- PROGRAM TIMER

- ON-STOP
- START
- OIL PUMP
- POWER
- SAFETY CIRCUIT
- LOAD RECYCLE
- PROGRAM TIMER

- ON-STOP
- START
- OIL PUMP
- POWER
- SAFETY CIRCUIT
- LOAD RECYCLE
- PROGRAM TIMER

- ON-STOP
- START
- OIL PUMP
- POWER
- SAFETY CIRCUIT
- LOAD RECYCLE
- PROGRAM TIMER

TROUBLESHOOTING GUIDE (Contd)

TROUBLE/SYMPTOM	PROBABLE CAUSE	REMEDY
<input checked="" type="checkbox"/> OIL PUMP light goes on 10 to 30 seconds after pushing START button; goes out after about one minute. START light goes out.	Water pumps not running.	Start pumps. Check pump starter(s) and relay(s).
	Water flow switches open (pumps running).	Check contacts of flow switches. Check for air in water line; vent air.
	Oil pump starter auxiliary contacts M3 open (oil pressure normal).	Check contacts.
	Oil low-pressure switch open (oil pressure normal).	Check setting of oil low-pressure switch. Check that both sets of contacts close when oil pressure is normal.
COMPRESSOR TRIPS OFF (Note: See Machine Recycle, page 23.) All panel lights out.	Power failure.	Check for building power failure. Check main circuit breaker and/or fuses.
	Blown fuse.	Check 15-amp fuse in control circuit; examine circuit for ground or short.
<input checked="" type="checkbox"/> OIL PUMP light goes out approximately 40 seconds after compressor stops. START light goes out, but SAFETY CIRCUIT light stays on.	Low oil pressure.	Check oil level in reservoir. Check for dirty oil filters.
	Oil pump not operating (button depressed).	Check for open oil pump disconnect. Check for faulty pump wiring. Check for faulty oil pump.
	Water-flow switch(es) open.	Pump(s) off; check starting equipment. Insufficient water flow; check water valves. Check for air in water lines; vent air. Defective flow switch; check contacts of switch.
	Momentary power interruption.	Push START button. Compressor will restart within 15 minutes.
Panel lights as shown; START light and SAFETY CIRCUIT light go out.	Circuit breaker CB1 tripped; high bearing temperature.	<div style="border: 1px dashed black; padding: 5px; text-align: center;"> Check bearing thermometer. If over 180 F, or if no one was present when machine stopped, DO NOT ATTEMPT TO RESTART MACHINE! Contact your Carrier representative. </div> Check for high oil reservoir temperature. Check oil cooler water flow. Check relay KB by replacing it with relay KM.
	Circuit breaker CB2 tripped; high motor winding temperature.	Check motor cooling system; clean orifices; clean refrigerant strainer. Check relay KM by replacing it with relay KB.
	Cooler low-temperature switch tripped.	Manually reset switch and: Check that capacity control switch is at "Auto." position. Check for refrigerant loss. Determine and correct cause and add refrigerant. Low chilled water recycle switch should trip out machine before cooler low temperature switch. If chilled water temperature is low, check settings of both switches.
	Condenser high-pressure switch tripped.	Manually reset switch and Check condensing water flow. Check condenser water temperature; if high, examine cooling tower operation. Check for air and water leaks, fouled tubes (see Maintenance section).
	Motor overload relays tripped.	Manually reset relays in starter and: Check that guide vanes stop opening when motor current exceeds 100% of full load amps. Adjust electrical demand control, if required, per 19DG Initial Start-Up section. Check overload relay setting per starter manufacturer's instructions.
	Blown fuse.	Check 3-amp fuse in control circuit; examine circuit for ground or short

TROUBLESHOOTING GUIDE (Contd)

TROUBLE/SYMP TOM	PROBABLE CAUSE	REMEDY
COMPRESSOR RUNS BUT GUIDE VANES WILL NOT OPEN.	Capacity control switch improperly set.	Turn switch to "Auto." position.
	Compressor not in "Run" condition.	At least one minute after compressor starts, check for 120 volts across 18 and L1 .
	K2 or K3 relay open.	Check continuity between 73 and 74 .
	Guide-vane-close oil pressure switch defective.	Ensure that oil pressure is at least 19 psi differential. Check continuity between V2 and 31 .
	Motor current calibration incorrect.	See Calibrate Motor Current, page 6.
	Chilled water probe defective.	Check probe resistance per Fig. 6. Replace.
CHILLED WATER TEMPERATURE TOO HIGH (machine running).	Incorrect voltage in capacity control module.	Check for +24 volts on <i>DC scale</i> , between 30 and 28 (ground); -24 volts, DC between 81 and 28 (ground). Replace module if voltage varies from above.
	Thermostat set too high.	Return thermostat to proper setting as marked on dial at initial start-up.
	Excessive cooling load (machine at capacity).	Check for infiltration of outside air into conditioned spaces.
	Condenser temperature too high.	Check condensing water flow. Check condensing water temperature; examine cooling tower operation. Check for air and water leaks, fouled tubes.
	Refrigerant level low.	Check for leak; repair. Add refrigerant.
	Liquid bypass in water box.	Examine division plates and gaskets for leaks.
	Excess throttling range (should be near minimum for proper control).	Reduce throttling range by turning adjusting screw clockwise in small increments.
Guide vanes fail to open fully.	Ensure that capacity control switch is in "Auto." position. If vanes will not open with switch at "Inc," check for excessive cooling load (see above). Check relays K2 and K3. Check guide vane linkage. (See Fig. 5.) Check cycling timer. If all else fails, replace capacity control module.	
CHILLED WATER TEMPERATURE TOO LOW (machine running).	Thermostat set too low.	Return thermostat to setting marked on dial at initial start-up.
	Low chilled water switch improperly set.	Water chilling duty — Switch should open at 5 F below design chilled water temperature, or at 37 F, whichever is higher. Brine chilling duty — Switch should open at 5 F below design leaving brine temperature
	Excess throttling range (should be near minimum for proper control).	Reduce throttling range by turning adjusting screw clockwise in small increments.
	Guide vanes fail to close.	Ensure that capacity control switch is in "Auto." position. Check chilled water probe resistance per Fig. 6. Check guide vane linkage. (See Fig. 5.) If all else fails, and vanes close in "Dec" but not in "Auto.," replace capacity control module.
CHILLED WATER TEMPERATURE FLUCTUATES: VANES HUNT	Throttling range too narrow.	Add throttling range by turning adjusting screw counterclockwise in small increments.
	Defective capacity control module.	Replace module.
	Loose vane linkage.	Adjust guide vane linkage. (See Fig. 5.)
	Defective vane actuator.	Replace actuator.

TROUBLESHOOTING GUIDE (Contd)

TROUBLE/SYMPTOM	PROBABLE CAUSE	REMEDY
OIL RESERVOIR TEMPERATURE TOO LOW.	Oil cooler water flow too high.	Throttle water to reduce flow.
	Thermostat improperly set or defective.	Check voltage across thermostat while adjusting it; if contacts do not close, replace thermostat.
	Oil heater defective.	If light indicates power but unit does not heat, check unit for open or short. Replace unit if required.
OIL RESERVOIR TEMPERATURE TOO HIGH.	Thermostat improperly set.	Adjust thermostat.
	Oil cooler water flow too low.	Open plug valve (item 12, Fig. 1).
	Oil cooler solenoid valve operating improperly.	Check electrical operation of solenoid. Inspect valve; if screen is fouled, install a 20-mesh screen ahead of valve.
	Oil cooler tubes fouled.	Clean or replace tubes if required.
PURGE DOES NOT OPERATE IN "AUTO." POSITION.	Normal	Purge pump does not operate unless purge pressure is within 2 to 4 psi of condenser pressure. Check gage readings.
	Blown fuse. (On some units.)	Check 15-amp fuse inside purge electrical switch box (on some units).
	Loose connections or broken wires.	Check purge control switch connections. Check circuit to purge motor, indicator light, solenoid switch and solenoid valve by switching to "Manual." Check purge operating and safety switch connections.
	Defective purge control switch.	Check switch continuity; replace switch if required.
	Incorrect purge safety or operating switch settings.	Check switches per Table 2 with metered supply of air. Recalibrate or replace as required.
PURGE CYCLES OFTEN IN "AUTO." POSITION.	Purge valves not tightly closed.	Check valve settings per purge valve chart (see Fig. 12). Close applicable valves securely.
	Solenoid and check valve leaking.	Close valves 4, 5 and 6 and remove inlet pipe plug from purge pump. Allow cigarette smoke to drift past pump inlet. If smoke is drawn into line, repair or replace valves
	Incorrect purge operating switch setting.	Check switch per Table 2 with metered supply of air. Recalibrate or replace as required.
	Excessive air leakage into machine.	Check machine for leaks per Air and Water Leaks section, page 11.
	Purge condensing chamber float valve stuck in closed position, or refrigerant return line plugged.	If refrigerant level is above sight glass, valve is stuck or line is plugged. Correct as required.
EXCESSIVE REFRIGERANT LOSS.	Purge pump cycles often.	See Purge Cycles Often In "Auto." Position, above.

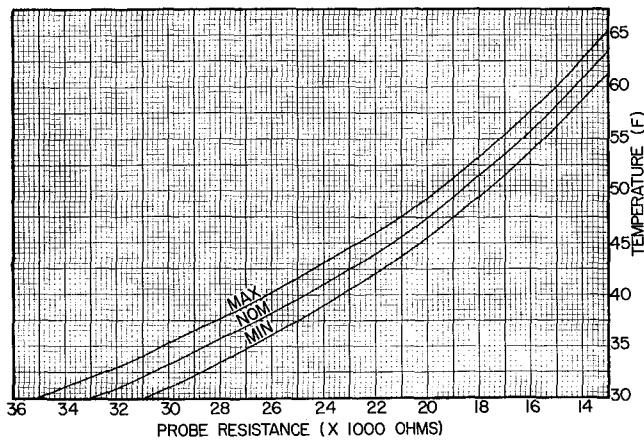

Fig. 6 — Chilled Water Probe Resistance versus Temperature (Electronic Control Only)

GENERAL DATA

Machine Informative Plate (item 15, Fig. 1) is located on the compressor support base at the left of the machine control center.

System Components include cooler and condenser heat exchangers within a single shell (unishell), motor-compressor, lubrication package, purge and control center.

COOLER — This heat exchanger, in the bottom portion of the unishell, is maintained at low temperature-pressure so that evaporating refrigerant can remove heat from water flowing thru its tubes.

CONDENSER — Heat exchanger in the unishell upper portion operates at a higher temperature-pressure at which heat may be removed from the refrigerant and be passed out of the system.

MOTOR-COMPRESSOR maintains system temperature-pressure differences and moves the heat carrying refrigerant from cooler to condenser.

LUBRICATION PACKAGE, consisting of oil pump, filter, cooler and thermostatically controlled heater, lubricates the motor-compressor, maintains the oil at proper operating temperature and pressure and removes foreign particles.

PURGE automatically separates air or other non-condensables from the refrigerant and collects any water for periodic manual removal. The purge may also be used for machine evacuation or pressurization.

CONTROL CENTER regulates machine capacity as required, registers cooler, condenser and lubricating system pressures, shows machine operating condition thru indicating lights, contains machine safety devices and records machine operating hours. Machine start, stop and recycle is sequenced by a program timer.

REFRIGERATION CYCLE

The compressor continuously draws refrigerant vapor from the cooler, at a rate set by the amount of guide vane opening. As the compressor suction reduces the pressure in the cooler, the remaining

refrigerant boils at a fairly low temperature (typically 34 – 38 F). The energy required for boiling is obtained from the water flowing thru the cooler tubes. With heat energy removed, the water becomes cold enough for use in an air conditioning circuit or for process liquid cooling.

After taking heat from the water, the refrigerant vapor is compressed. Compression adds still more heat energy and the refrigerant is quite warm (typically 100 – 105 F) when it is discharged from compressor into condenser.

Relatively cool (typically 65 – 85 F) water flowing thru the condenser tubes removes heat from the refrigerant and the vapor condenses to liquid. The condensing water carries the heat out of the system while the cooled liquid refrigerant drains into a float chamber between condenser and cooler.

Here a float valve forms a liquid seal to keep condenser vapor from entering the cooler and to maintain the pressure difference between condenser and cooler.

When liquid refrigerant passes thru the valve, some of it flashes to vapor in the reduced pressure on the cooler side. In flashing, it removes heat from the remaining liquid. The refrigerant is now at the temperature and pressure at which the cycle began.

In the 19DG machine, a refrigerant agitator (Fig. 3 and 7) maintains efficient machine performance at minimum load. The agitator system is activated whenever the compressor guide vanes are less than 25% open and the cooler-condenser pressure difference is at least 6 – 8 psi.

The agitator opens the condenser float valve slightly and allows a small amount of condenser gas to pass into the cooler. The gas agitates the liquid refrigerant, raising the effective refrigerant level and improving heat transfer.

MOTOR COOLING CYCLE

The motor is cooled by refrigerant taken from the condenser float chamber at condenser pressure. The flow is maintained by pressure difference in the system.

The liquid refrigerant first flows thru a sub-cooler coil at the bottom of the cooler (Fig. 7). It then passes thru a filter to spray nozzles at the end of the rotor. The spray nozzles atomize the refrigerant and direct the cooling vapor over both the rotor and the stator. The cycle is completed by the return of the refrigerant to the cooler.

When condensing temperature and pressure are low, as at start-up and low load, a minimum head control (Fig. 3 and 7) holds the float valve closed until cooler-condenser pressure difference is sufficient for good refrigerant flow thru the motor cooling circuit.

The compressor motor is protected against high temperature by a thermostat imbedded in the windings. Above-normal motor temperature will immediately shut down the machine.

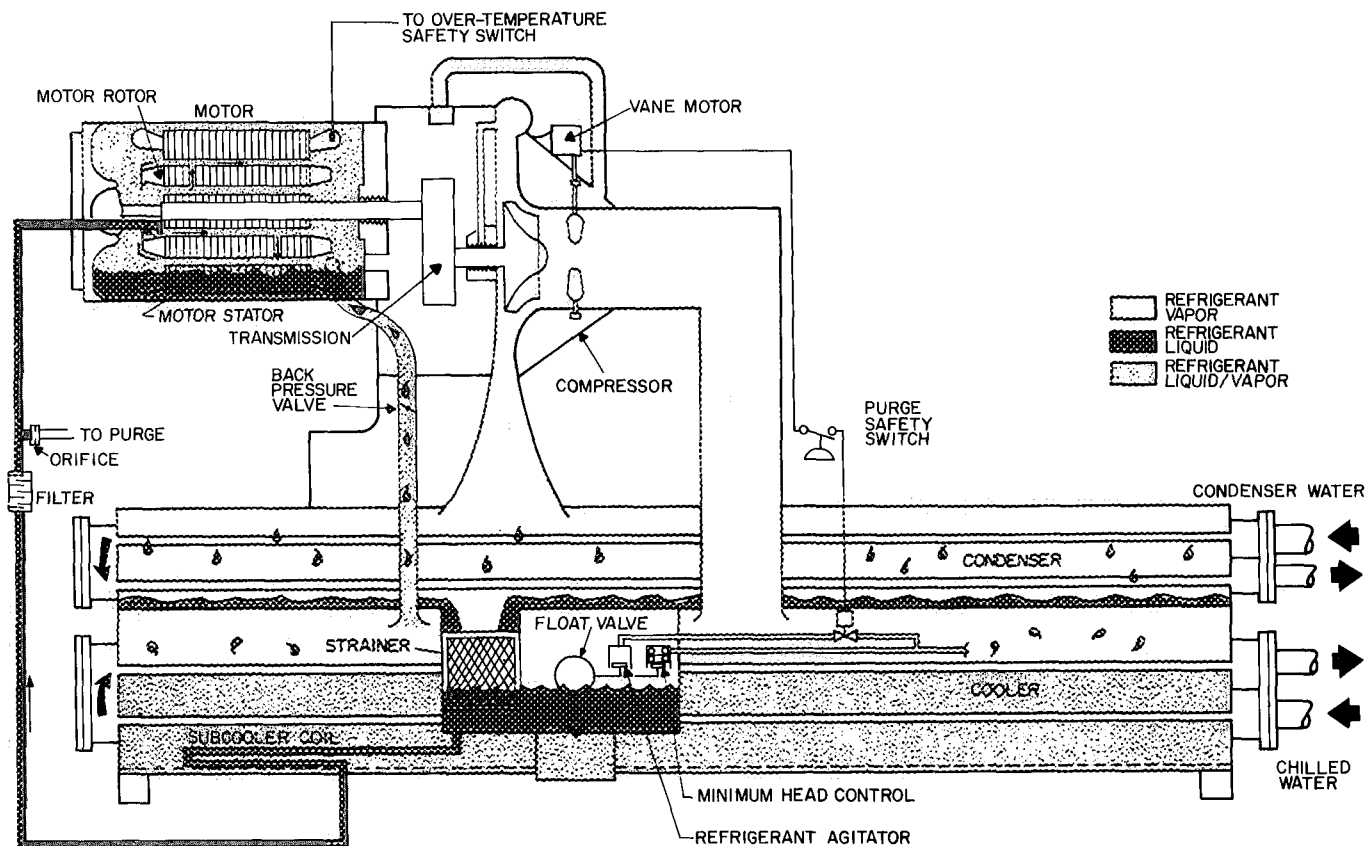

Fig. 7 – Refrigeration and Motor Cooling Cycles

LUBRICATION CYCLE

Summary – The oil pump, filter and cooler make up a package located partially within the end of the unishell (Fig. 8). The oil is pumped thru the filter-cooler to remove foreign particles and excess heat. Part of the oil flow is directed to the compressor motor end bearing. The remaining flow lubricates the compressor transmission, journal and thrust bearings. Oil then drains into the reservoir to complete the cycle.

Details – Oil is charged into the lubrication package thru a hand valve. A sight glass in the oil reservoir permits oil level observation.

Oil pump discharges oil thru oil filter and oil cooler coils. Oil cooler water flow may be adjusted by a plug valve to maintain proper oil temperature (140 – 150 F). If desired, the customer may install a throttling valve for this purpose. A solenoid valve shuts off the water supply at machine shutdown.

An oil pressure relief valve maintains 20 – 25 psi differential pressure in the system. This differential pressure can be read by subtracting oil reservoir pressure from oil supply pressure.

Oil leaving the filter-cooler passes over a magnetic plug which removes any metallic particles. A portion of the oil then flows to the motor end bearing and the balance lubricates the compressor thrust and journal bearings and the transmission. As the oil leaves the transmission and main bearings, its temperature is registered on a gage.

The oil now drains into a reservoir at the base of the compressor. Gages on the compressor casing

register the temperature and pressure of the oil in the reservoir. An oil heater, with thermostat and indicating light, maintains oil reservoir temperature at 140 – 145 F on machine shutdown.

To ensure proper compressor lubrication during start-up and coastdown, a program timer in the machine control center energizes the oil pump for about 30 seconds before the compressor starts and keeps the pump running for about 40 seconds after the compressor motor is de-energized.

A guide-vane-close oil pressure switch minimizes oil foaming at start-up. If the guide vanes open quickly, the sudden drop in suction pressure can cause any refrigerant in the oil to flash. The resulting oil foam cannot be pumped efficiently; oil pressure falls off and lubrication is poor. The vane-close switch opens when oil pressure drops below 20 psi and causes the guide vanes to close by de-energizing relay K2.

If oil pressure drops to approximately 10 psi differential, an oil low-pressure cutout will shut down the machine.

PURGE CYCLE

The purge removes water, air or other non-condensable gases from the refrigerant system. It indicates air and water leaks and may be used to evacuate or pressurize the machine.

A sampling line from the condenser (Fig. 10) continually brings refrigerant gas, and any contaminants, into the purge condensing chamber.

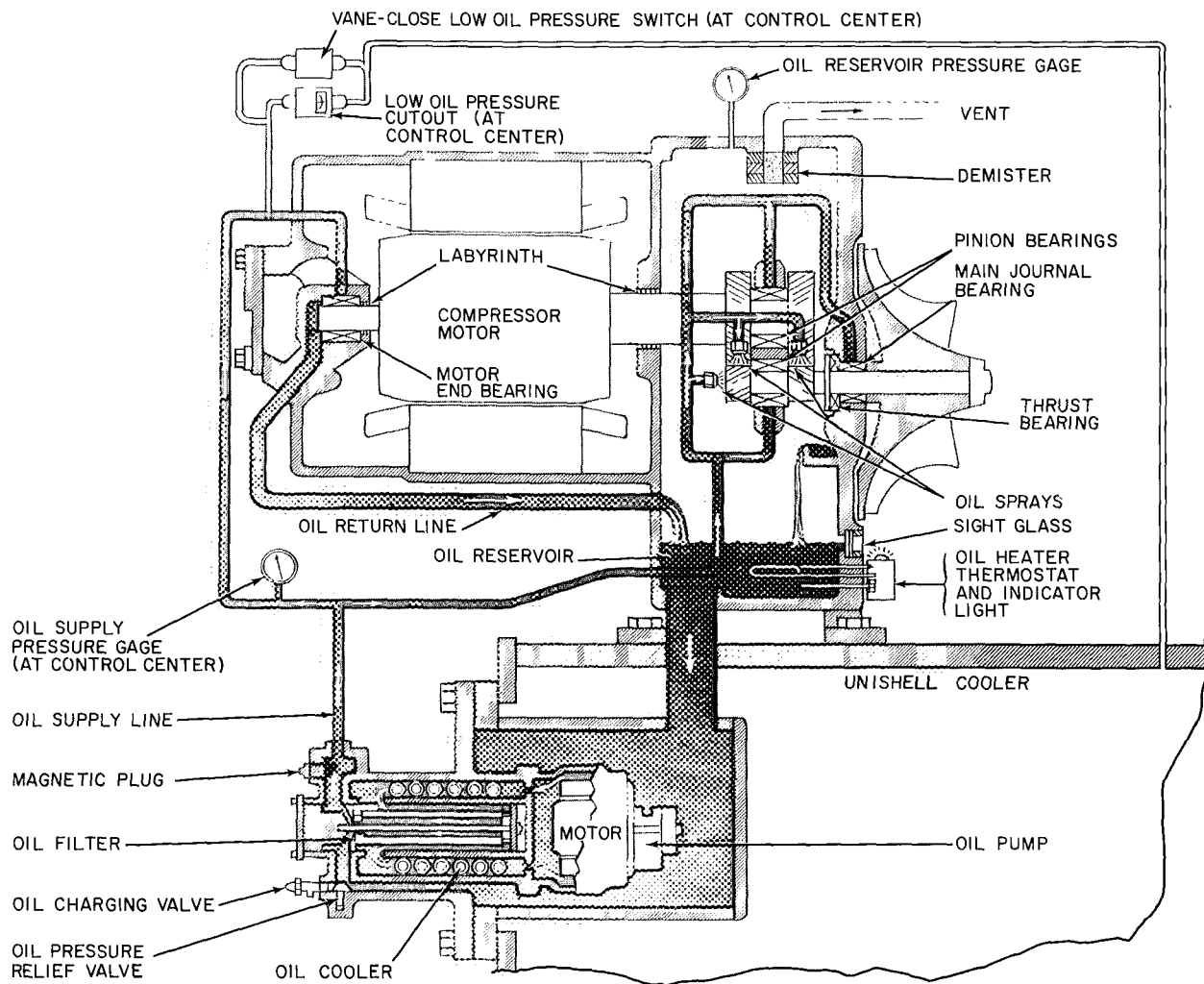

Fig. 8 - Lubrication Cycle

Here the gas-vapor mixture passes over a cooling coil. Since the refrigerant liquid within the coil is colder than the mixture surrounding it, the refrigerant gas and water are condensed to liquid.

Water, if present, separates from and floats on the heavier refrigerant. The water level may be observed thru a sight glass and the water may be withdrawn manually at the water drain valve (Fig. 10). The liquid refrigerant flows thru a U-trap and a float valve back to the cooler.

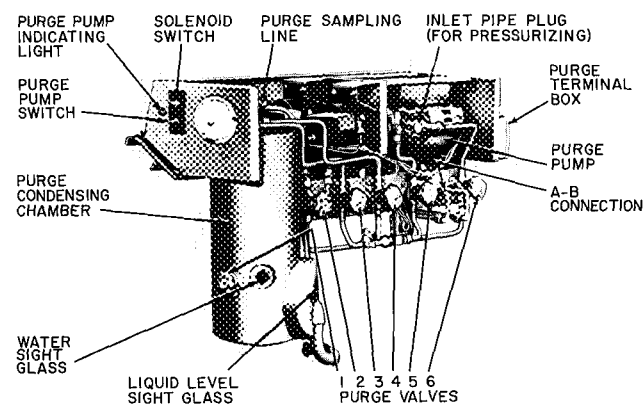

Fig. 9 - Purge Component Location

Air and other noncondensable gases collect in the upper part of the condensing chamber. When accumulating air raises the chamber pressure to within 2 psi of machine condenser pressure, the purge operating switch energizes the purge pump and opens the purge vent solenoid. The air is then discharged thru valve 6 (Fig. 10).

Since machine condenser pressure and purge chamber pressure also equalize at machine shutdown, air and then refrigerant could be discharged each time the machine stops. To prevent this, a purge safety switch opens whenever cooler and condenser pressure difference drops below 6 - 8 psi. The safety switch deactivates the purge "Auto." circuit until machine operation again builds up pressure differences within the refrigerant system.

Table 2 - Safety and Operating Switch Settings

SWITCH	NORMAL POSITION	DIFFERENTIAL PRESSURE SETTING		CONNECTION
		Cutout	Cut-in	
Purge Safety (P1)	Open	6 psi	8 psi	Condenser-Cooler
Purge Oper (P2)	Closed	4 psi	2 psi	Purge Condenser-Machine Condenser

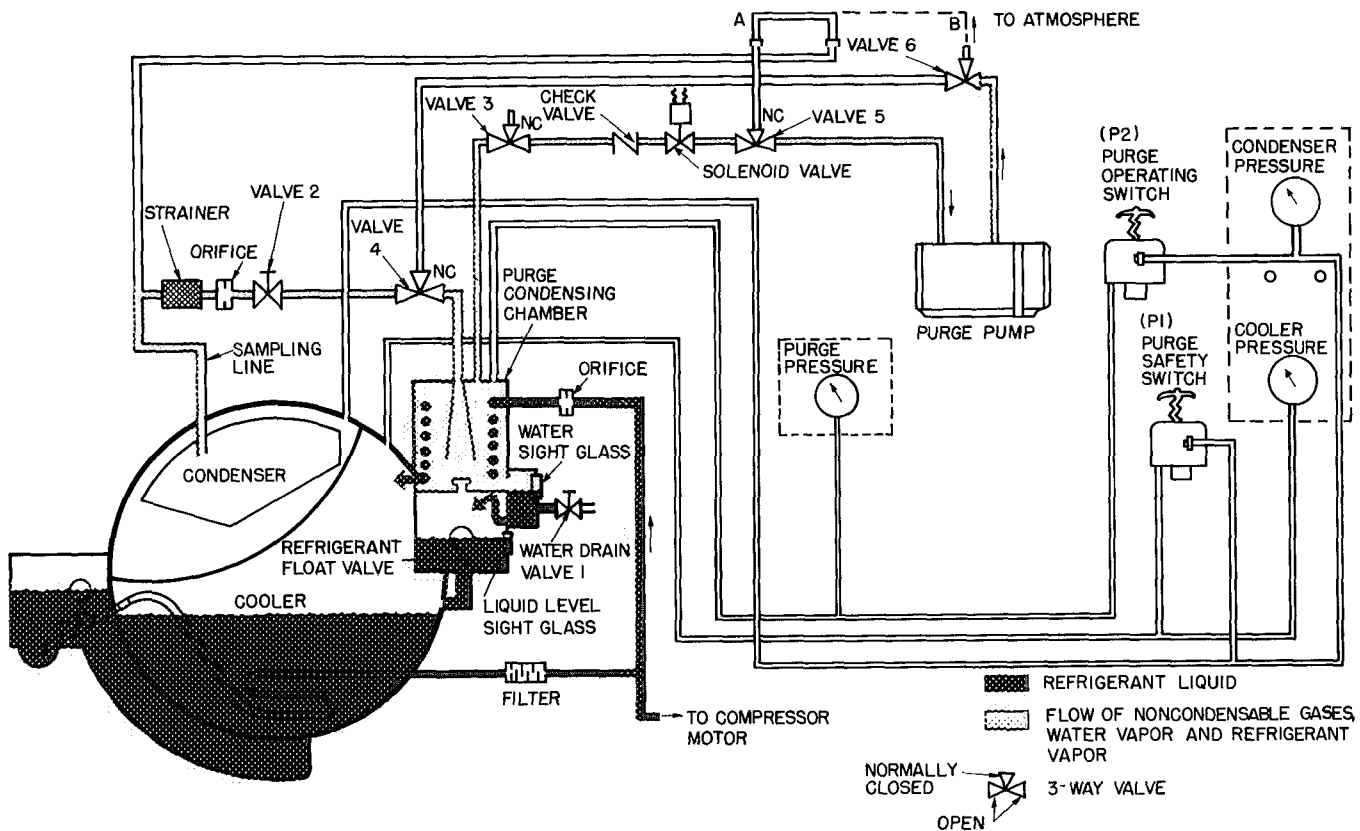

Fig. 10 – Purge Cycle

Purge Operation – The standard operating mode is “Normal-Automatic.” The purge MANUAL-OFF-AUTO. switch is placed at “Auto.” position and the solenoid switch at “On.” As the machine starts up, the purge safety switch will close and the purge operating switch will open. The purge pump and solenoid valve will be energized whenever purge chamber pressure nears machine condenser pressure. When the chamber pressure drops during air discharge, the pump and solenoid valve will de-energize automatically.

If the control switch is placed at the “Manual” position, the purge pump will operate continuously without regard to whether the safety and operating switches are closed or open. Manual operation is used for removing air from the machine after service work or for pressurizing the machine for leak testing.

OPERATION R-11 PURGE	VALVE NUMBER						SWITCH	
	1	2	3	4	5	6	Purge	Sol
1 Normal – Automatic	Close	Open	Close	Close	Close	Open	Auto.	On
2 Remove air after opening machine	Close	Close	See Note 3	Open	Open	Close	Man.	Off
3 To pressurize system for leak test (See note 1.)	Close	Close	Close	Close	Close	Open	Man.	Off
4 To remove water (See note 2.)	Open Note 2	Close	Open	Close	Close	Close	Off	Off

NOTES:

1. Move tube from fitting A to B and remove pipe plug from purge pump inlet.
2. When purge pressure gage reads zero, open water drain valve 1.
3. Set valve 3 so that purge gage reads 15 to 18 psi, with purge pump running.

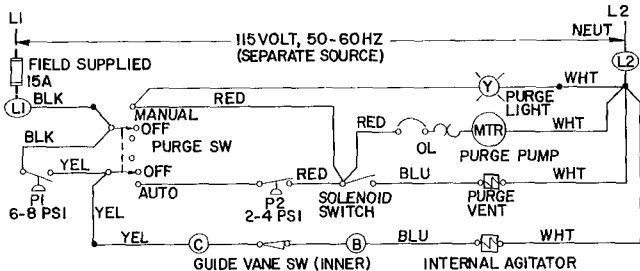

- P1 – Purge Safety Switch
- P2 – Purge Operating Switch
- Purge Terminal
- Guide Vane Actuator Terminal
- Field Wiring

Fig. 11 – Typical Purge Wiring

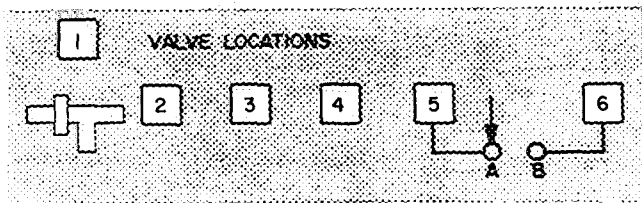

It is recommended that the purge unit be operated in “Normal-Automatic” position whenever the machine compressor is running.

If excessive air enters the unit, either during operation or shutdown, the purge can be operated in condition 2. Do not run in this manner continuously.

Fig. 12 – Purge Valve and Switch Settings

CONTROLS

General — The basic 19DG controls and wiring are described in this section. Actual machine control systems may vary in some respects, depending upon job specifications.

Description — Machine capacity is controlled by the opening and closing of compressor guide vanes. A temperature sensing probe in the leaving chilled water circuit transmits signals to a capacity control module. In response to probe signals, the module activates the compressor guide vane motor, moving the guide vanes towards a closed position as chilled water temperature decreases, and opening the vanes as temperature rises.

If at any time compressor motor current requirements should exceed the electrical demand control setting (item 7, Fig. 2), a signal from the compressor motor starter overrides the signal from chilled water temperature probe. The guide vanes will then move towards a closed position until motor current falls below electrical demand setting.

Safety controls shut down machine to protect it against damage from compressor bearing high temperature, motor-winding high temperature, cooler refrigerant low temperature, condenser high pressure, oil low pressure and loss of water flow. These shutdowns require manual restart.

If chilled water temperature should drop approximately 5 F below the selected set point, the chilled water low-temperature cutout and recycle switch will stop the compressor. The compressor will restart automatically when the water temperature rises to approximately 5 F above the setpoint and the program timer has completed a 15-minute delay between compressor stop and restart.

The vanes-closed switch ensures that compressor starts in an unloaded condition (guide vanes closed).

The minimum head control and the refrigerant agitator are described in the Refrigeration Cycle and Motor Cooling Cycle sections, page 17.

The guide-vane-close oil pressure switch is described in the Lubrication Cycle section, page 18.

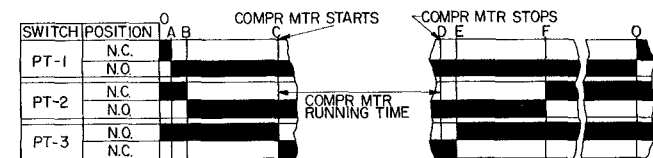

LEGEND

- O = Starting sequence begins (condition shown on schematic)
- A = 13 ± 5 sec after O
- B = 10 ± 8 sec after A (oil pump starts)
- C = 28 ± 8 sec after B (compr motor starts and program timer stops)
- D = Time at which compressor motor stops and program timer starts.
- E = 13 ± 5 sec after D
- F = 28 ± 8 sec after E (oil pump stops)
- O = 15 min ± 15 sec total cycle time (D to C)

N.C. — Normally Closed
N.O. — Normally Open

Fig. 13 — Program Timer Sequence

Program Timer (item 4, Fig. 2) — The 19DG program timer ensures positive compressor lubrication prior to compressor start and during coastdown after machine stop. It prevents short cycling and motor damage by preventing compressor restart until 15 minutes after stop.

The program sequence is graphically illustrated in Fig. 13. Switch numbers and positions are those marked on the machine wiring schematic, Fig. 15.

Oil Heater and Thermostat — These items are typically wired by the field as indicated in Fig. 14.

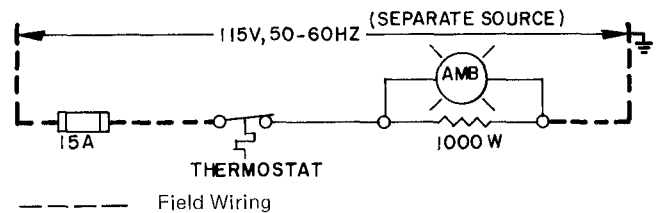

Fig. 14 — Oil Heater Wiring Schematic

Machine Control Wiring — Typical machine control wiring is shown schematically in Fig. 15. Your machine wiring may differ in some details. Check your individual Job Data.

Typical Control Sequence — Machine Start (Refer to Fig. 15.)

1. Supply power to machine.
POWER light goes on.
2. Press water pump start button (line 2).
 - a. Pilot relay (PR) energizes water pumps and cooling tower fan. PR contact holds relay in.
 - b. Water flow switches (line 17) close.
3. Press ON-STOP button.
 - a. Relays KB and KM are energized thru bearing and motor thermostats (lines 9 and 10).
 - b. KB and KM contacts (lines 11 and 12) open breaking circuit to CB1 and CB2 thermal elements (lines 11 and 12).
 - c. KB and KM contacts (line 13) close, completing circuit to cooler refrigerant and condenser high-pressure switches, compressor motor overloads, K4 contact and low chilled water temperature switch. Oil low-pressure switch (line 17) and water flow switches are temporarily bypassed.
 - d. ON-STOP, SAFETY CIRCUIT and LOAD RECYCLE lights go on.
4. Press machine START button.
 - a. K1 is energized and is held in by its holding contact. Second K1 relay contact (line 22) closes circuit to program timer motor.
 - b. START and PROGRAM TIMER lights go on.
5. PT-1 moves to N.O. position; timer motor is kept energized thru 1CR N.C. contact.

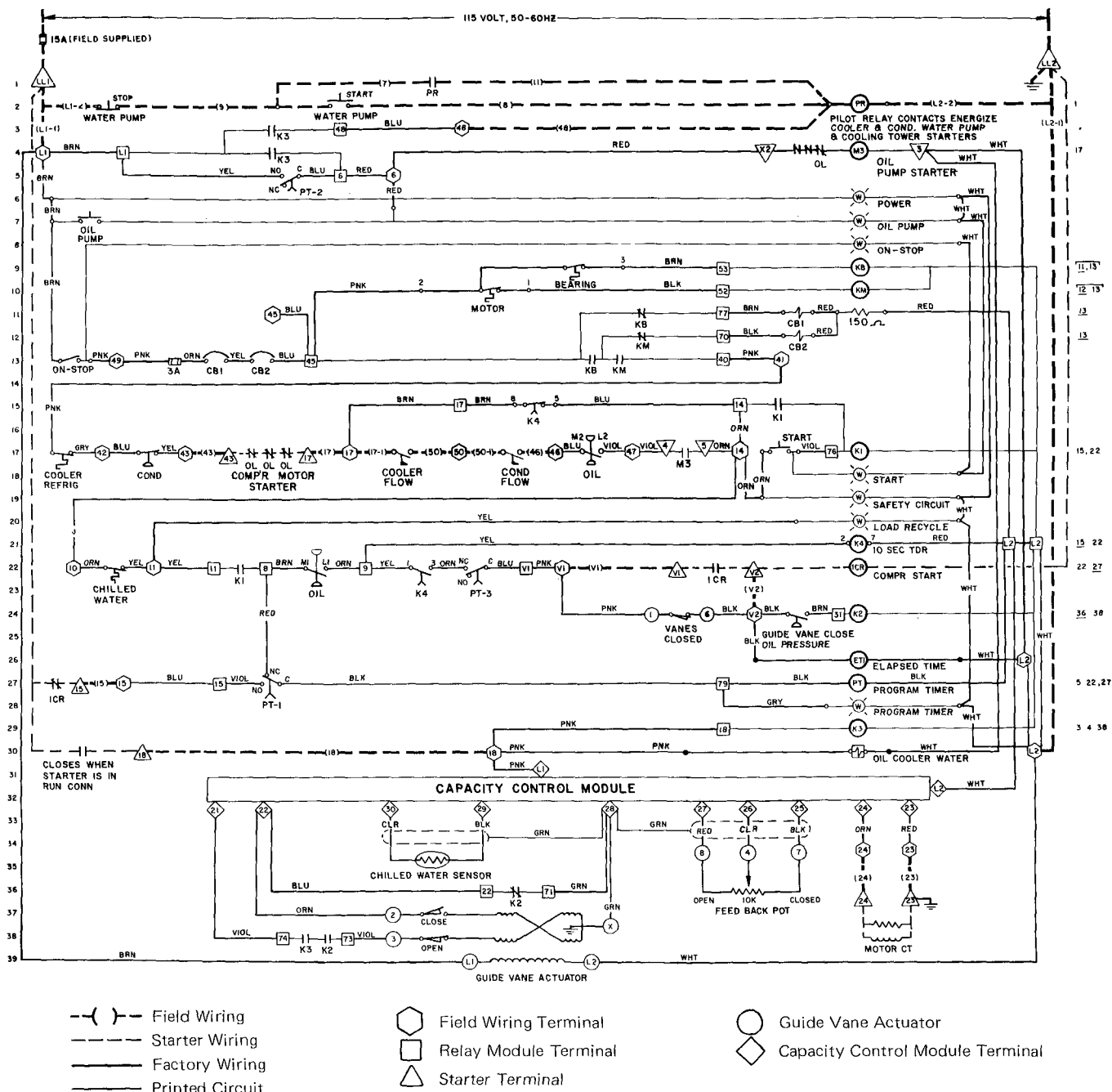

Fig. 15 – Machine Control Wiring Schematic

6. PT-2 moves to N.O. position.
 - a. Power reaches oil pump starter M3.
 - b. OIL PUMP light goes on.
 - c. Oil pressure builds up. Contacts (lines 17 and 22) close. Guide-vane-close oil pressure switch (line 24) closes.
 - d. K4 time-delay relay is energized. In 10 seconds, contact (line 15) opens; safety circuit is completed thru M3 contact, low oil pressure switch and water flow switches. K4 contact (line 22) closes circuit to PT-3.
7. PT-3 moves to N.C. position. Compressor motor start relay 1CR and relay K2 are

energized thru VANES CLOSED switch. Compressor starts.

- a. 1CR contact (line 22) closes to hold in 1CR relay.
 - b. 1CR contact (line 27) opens; program timer stops and PROGRAM TIMER light goes out.
 - c. K2 contact (line 36) opens and removes "close" signal from guide vane actuator.
8. Compressor reaches "run" condition.
 - a. Relay K3, oil cooler, solenoid valve and capacity control module are energized.

- b. K3 contacts close to interlock oil pump, water pumps and cooling tower fan (lines 3 and 4).
- c. K2 and K3 contacts (line 38) are now closed to allow an "open" signal to be applied to the guide vane actuator.

Typical Control Sequence – Machine Stop

1. Push ON-STOP switch.
 - a. All machine control relays are de-energized.
 - b. As 1CR relay drops out, compressor stops, 1CR contact (line 27) closes and program timer starts.
 - c. As K3 relay drops out, its contacts (lines 3 and 4) open and remove interlocking circuits to water pumps, cooling towers and oil pump starter.
 - d. Third K3 contact (line 38), and both K2 contacts return to de-energized condition and guide vanes close.
 - e. ON-STOP, START, SAFETY CIRCUIT and LOAD RECYCLE lights go off; PROGRAM TIMER light goes on.
2. In a few seconds, PT-3 moves to its N.O. position, preventing compressor start relay from being energized for 15 minutes.
3. PT-2 moves to N.C. position about 40 seconds after ON-STOP switch was pushed. Oil Pump stops. Oil pump light goes off.
4. In approximately 14 minutes, PT-1 moves to its N.C. position. Program timer stops and light goes off. Machine may be restarted.

Typical Control Sequence – Machine Recycle

During normal cooling, the building load may drop low enough to make continuous operation of the refrigeration machine unnecessary. When chilled water temperature reaches its low cutout point, the machine shuts off automatically. It remains off for a minimum of 15 minutes and until the rise in chilled water temperature closes the switch contacts. The machine then restarts automatically.

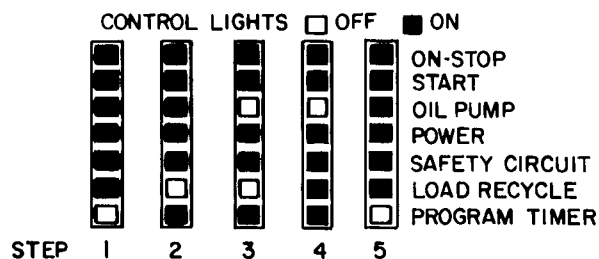

1. Machine operating normally.
2. Low chilled water temperature cutout opens. Relay 1CR de-energizes; compressor stops; program timer starts.
3. Oil pump stops approximately 40 seconds after compressor.

4. Chilled water temperature rises and low chilled water temperature cutout closes.
5. Program timer completes its cycle; machine restarts automatically (15 minutes minimum from stop to restart).

CONTROL OPTIONS

General – This section presents a brief description of the most common optional controls and their operation. Installation and calibration of optional controls are covered in the instructions accompanying each accessory package. Your nearest Carrier office can provide you with this information if required.

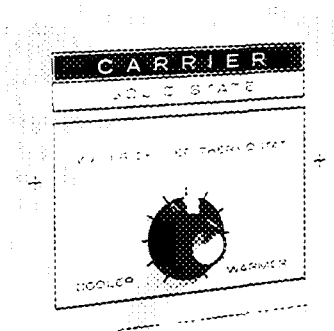

Remote Thermostat – This setpoint control permits selection and alteration of the leaving chilled water temperature from a central station or other location of the customer's choice.

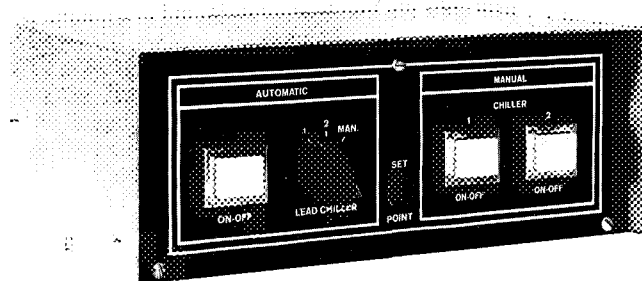

Lead-Lag Control provides centralized control of 2 refrigeration machines. Control may be applied to parallel machines, series machines with a common control point or series machines with a split control point.

PREPARATION – On initial start only, push the ON-STOP and START buttons (lights go on) at each control center. Machine start and stop can now be made at the lead-lag control.

AUTOMATIC OPERATION – When the lead-lag ON-OFF button at the left side of the control is pushed and lighted, the chillers, water pumps and tower fans will start and stop automatically in response to a field-supplied outside-air thermostat or other device. The transfer switch permits selection of either machine for part load recycle.

MANUAL OPERATION – With the transfer switch at "Man." position, either or both chillers may be stopped or started manually by pushing the ON-OFF buttons at the right side of the control.

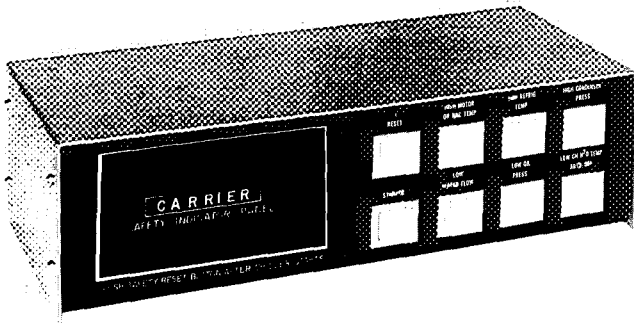

Safety Indicator Panel provides first out indication for each of the 7 machine safety controls listed below, plus the sounding or lighting of an optional remote alarm.

First-out indication is given for:

1. High motor or bearing temperature
2. Low refrigerant temperature
3. High condenser pressure
4. Motor overload
5. Insufficient water flow (cooler and condenser)
6. Low oil pressure
7. Low chilled water temperature

SETTING THE INDICATOR PANEL – After the refrigeration machine has been started, press the panel SAFETY RESET button. The panel is now in the ready condition. All lights will remain off until the machine shuts down on a safety cutout. The indicator lamp for that particular safety will light and, except for LOAD RECYCLE/AUTO. OFF lamp, will remain lit until panel is reset. The LOAD RECYCLE/AUTO. OFF lamp will go out when chilled water temperature rises and the switch remakes.

RESETTING THE INDICATOR PANEL

1. Correct the condition which caused the safety tripout (except low chilled water temp).
2. Reset the safety control if manual reset.
3. Restart the refrigeration machine.
4. Press the indicator panel SAFETY RESET button.

PRESS-TO-TEST FEATURE – To check the condition of any indicator lamp, merely press the lamp button. The lamp will light. A burned out lamp does not affect the operation of the alarm circuit. This lamp test does not in any way indicate whether the actual safety control is tripped or not.

If an alarm has been added to the panel, it will sound and/or light when the LOW OIL PRESSURE button is pressed.

Autostart Control – Automatic machine and auxiliary start and stop in response to an outside-air thermostat, time clock or other customer-supplied device is available as a modification to the refrigeration machine starter. Figure 16 shows a typical autostart circuit. For application of this circuit to machine control system, refer to your Job Wiring Data.

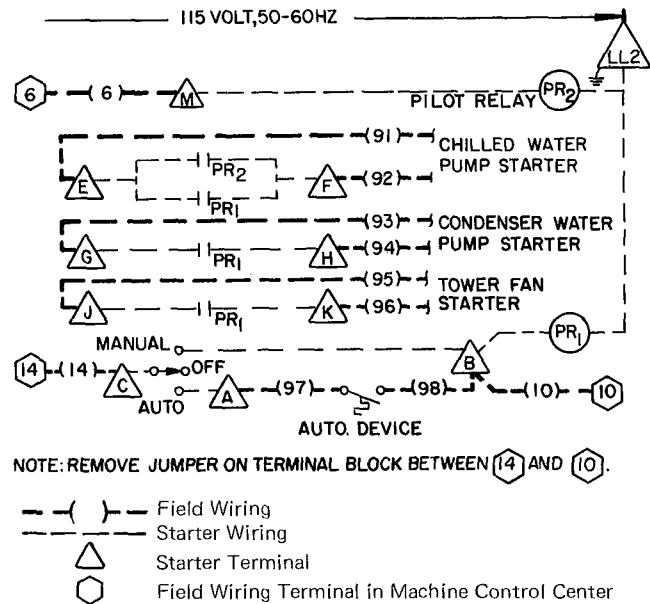

Fig. 16 – Autostart Connection Diagram (Typical)

INSTRUCTING THE OPERATOR

Be sure that the operator understands all operating instructions. Point out the various machine parts and explain their function within the system.

Compressor-Motor Assembly – guide vanes, vane motor and linkage, refrigerant cooling system.

Unishell Cooler-Condenser – float chamber, sight glasses, thermowells, relief devices, charging valve.

Purge System – sight glasses, gage, valves and system operation, importance of purge.

Lubrication System – oil pump, cooler, filter, heater, thermostat, temperature and pressure gages, pressure regulating valve, solenoid valve and plug valve, operating levels and temperatures.

Control System – indicating lights, gages, adjustment of safety and operating controls, auxiliary and special controls.

Auxiliary Equipment – starters, pumps, cooling tower.

Review Maintenance – importance of log sheet, water treatment.

Discuss Carrier Service – availability, method of ordering parts.

For replacement items use Carrier Specified Parts.

Manufacturer reserves the right to discontinue, or change at any time, specifications or designs without notice and without incurring obligations.

Free Manuals Download Website

<http://myh66.com>

<http://usermanuals.us>

<http://www.somanuals.com>

<http://www.4manuals.cc>

<http://www.manual-lib.com>

<http://www.404manual.com>

<http://www.luxmanual.com>

<http://aubethermostatmanual.com>

Golf course search by state

<http://golfingnear.com>

Email search by domain

<http://emailbydomain.com>

Auto manuals search

<http://auto.somanuals.com>

TV manuals search

<http://tv.somanuals.com>