

Visit www.carrier.com

Installation, Start-Up and Service Instructions

NOTE: Read the entire instruction manual before starting the installation.

TABLE OF CONTENTS

SAFETY CONSIDERATIONS	1
INTRODUCTION	2
RECEIVING AND INSTALLATION	2
Check Equipment.....	2
IDENTIFY UNIT	2
INSPECT SHIPMENT.....	2
Provide Unit Support.....	2
SLAB MOUNT	2
GROUND MOUNT	2
Provide Clearances.....	2
Place Unit.....	2
Select and Install Ductwork	2
CONVERTING HORIZONTAL DISCHARGE	
UNITS TO DOWNFLOW (VERTICAL) DIS-	
CHARGE	4
Provide for Condensate Disposal	4
Install Electrical Connections.....	5
HIGH-VOLTAGE CONNECTIONS.....	5
ROUTING POWER LEADS INTO UNIT.....	6
CONNECTING GROUND LEAD TO UNIT GROUND.....	6
ROUTING CONTROL POWER WIRES	6
ACCESSORY ELECTRIC HEAT WIRING	6
PRE-START-UP	6
START-UP	7
Check for Refrigerant Leaks	8
LOCATE AND REPAIR REFRIGERANT LEAKS AND	
CHARGE THE UNIT AS FOLLOWS:	8
Start-Up Cooling Section and Make Adjustments	8
CHECKING COOLING CONTROL OPERATION	8
Refrigerant Charge.....	8
NO CHARGE.....	8
LOW CHARGE COOLING	9
HEATING MODE CHARGE.....	9
Indoor Airflow and Airflow Adjustments.....	9
FOR 208/230-V	13
Unit Controls.....	13
HIGH-PRESSURE RELIEF VALVE.....	13
LOSS OF CHARGE SWITCH.....	13
COMPRESSOR OVERLOAD.....	13
Sequence of Operation.....	13
FAN OPERATION.....	13
COOLING.....	14
HEATING.....	14
CONTINUOUS FAN	14
DEFROST.....	14
ELECTRIC RESISTANCE HEATING.....	14
MAINTENANCE.....	15
Air Filter.....	15
Unit Top Removal (Outdoor-Coil Side)	15

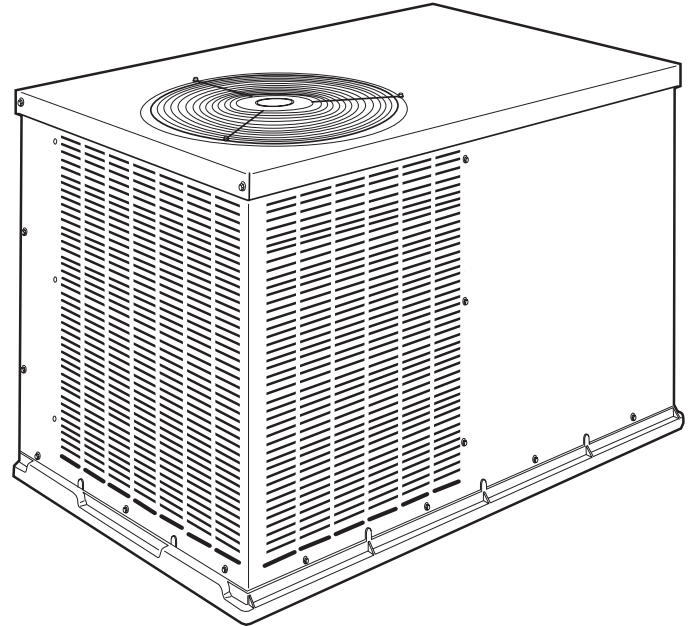

A05194

Fig. 1—Unit 50ZHA

Indoor Blower and Motor.....	15
Outdoor Coil, Indoor Coil, and Condensate Drain Pan	16
Outdoor Fan	16
Electrical Controls and Wiring.....	16
Refrigerant Circuit	17
Indoor Airflow	17
Metering Devices.....	17
Lubrication	17
Liquid Line Strainer.....	17
High Flow Valves.....	17
TROUBLESHOOTING	17
START-UP CHECKLIST.....	17
NOTE TO INSTALLER—Before installation, READ THESE	
INSTRUCTIONS CAREFULLY AND COMPLETELY. Also,	
make sure the User's Manual and Replacement Guide are left with	
the unit after installation.	

SAFETY CONSIDERATIONS

Installation and servicing of air-conditioning equipment can be hazardous due to system pressure and electrical components. Only trained and qualified workers should install, repair, or service air-conditioning equipment.

Untrained workers can perform basic maintenance functions of cleaning coils and filters. All other operations should be performed by trained service people. When working on air-conditioning equipment, pay attention to precautions in the literature, tags, and labels attached to the unit, and other safety precautions that may apply.

Manufacturer reserves the right to discontinue, or change at any time, specifications or designs without notice and without incurring obligations.

Follow all safety codes. Wear safety glasses and work gloves. Use quenching cloth for unbrazing operations. Have fire extinguisher available for all brazing operations.

⚠ WARNING

FIRE, EXPLOSION, ELECTRICAL SHOCK HAZARD
Failure to follow this warning could result in personal injury, death and/or property damage.
Before performing service or maintenance operations on system, turn off main power to unit and install lockout tag.
Turn off accessory heater power switch if applicable.

Recognize safety information. This is the safety-alert symbol . When you see this symbol in instructions or manuals, be alert to the potential for personal injury.

Understand the signal words DANGER, WARNING, CAUTION, and NOTE. These words are used with the safety-alert symbol. DANGER identifies the most serious hazards which **will** result in severe personal injury or death. WARNING signifies a hazard which **could** result in personal injury or death. CAUTION is used to identify unsafe practices which **may** result in minor personal injury or product and property damage. NOTE is used to highlight suggestions which **will** result in enhanced installation, reliability, or operation.

These instructions cover minimum requirements and conform to existing national standards and safety codes. In some instances, these instructions exceed certain local codes and ordinances, especially those that may not have kept up with changing residential construction practices. We require these instructions as a minimum for a safe installation.

INTRODUCTION

50ZHA heat pump units are fully self-contained and designed for outdoor installation (See Fig. 1). As shown in Fig. 2, units are shipped in a horizontal-discharge configuration for installation on a ground-level slab. All units can be field-converted to downflow discharge configurations for rooftop applications with a field-supplied plenum.

RECEIVING AND INSTALLATION

Step 1—Check Equipment

IDENTIFY UNIT

The unit model number and serial number are stamped on the unit identification plate. Check this information against shipping papers. Verify that unit voltage and amperage listed on unit rating plate agree with power supplied for equipment.

INSPECT SHIPMENT

Inspect for shipping damage while unit is still on shipping pallet. If unit appears to be damaged or is torn loose from its securing points, have it examined by transportation inspectors before removal. Forward claim papers directly to transportation company. Manufacturer is not responsible for any damage incurred in transit.

Check all items against shipping list. Immediately notify the nearest Carrier Distributor if any item is missing.

To prevent loss or damage, leave all parts in original packages until installation.

Step 2—Provide Unit Support

SLAB MOUNT

Place the unit on a rigid, level surface, suitable to support the unit weight. A concrete pad or a suitable fiberglass mounting pad is recommended. The flat surface should extend approximately 2-in. beyond the unit casing on the 2 sides. The duct connection side and condensate drain connection sides should be flush with the edge of the flat surface.

A 6-in. wide gravel apron should be used around the flat surface to prevent airflow blockage by grass or shrubs. Do not secure the unit to the flat surface except where required by local codes.

The unit should be level to within 1/4 inch. This is necessary for the unit drain to function properly.

GROUND MOUNT

The unit may also be installed directly on the ground if local codes permit. Place unit on level ground prepared with gravel for condensate discharge.

HURRICANE HOLD DOWN

Contact your local distributor for specific hurricane hold down details and PE (Professional Engineer) certification when required.

Step 3—Provide Clearances

The required minimum service clearances and clearances to combustibles are shown in Fig. 2. Adequate ventilation and outdoor coil air must be provided.

The outdoor fan pulls air through the outdoor coil and discharges it through the fan on the top cover. Be sure that the fan discharge does not recirculate to the outdoor coil. Do not locate the unit in either a corner or under an overhead obstruction. The minimum clearance under a partial overhang (such as a normal house overhang) is 48 in. above the unit top. The maximum horizontal extension of a partial overhang must not exceed 48 inches.

Do not place the unit where water, ice, or snow from an overhang or roof will damage or flood the unit. The unit may be installed on wood flooring or on Class A, B, or C roof covering materials.

⚠ CAUTION

OPERATIONAL HAZARD
Failure to follow this caution may result in unit component damage.
Do not restrict outdoor coil airflow. An air restriction at either the outdoor-air inlet or the fan discharge can be harmful to compressor life.

Step 4—Place Unit

Unit can be moved with the rigging holds provided in the unit base. Refer to Table 2 for operating weights. *Use extreme caution to prevent damage when moving the unit. Unit must remain in an upright position during all moving operations.* The unit must be level with in 1/4" for proper condensate drainage; the ground-level pad must be level before setting the unit in place. When a field-fabricated support is used, be sure that the support is level and that it properly supports the unit.

Step 5—Select and Install Ductwork

The design and installation of the duct system must be in accordance with:

- the standards of the NFPA (National Fire Protection Association) for installation of nonresidence-type air conditioning and ventilating systems
- NFPA90A or residence-type, NFPA90B; and/or local codes and residence-type, NFPA 90B
- and/or local codes and ordinances

Select and size ductwork, supply-air registers and return-air grilles according to ASHRAE (American Society of Heating, Refrigeration, and Air Conditioning Engineers) recommendations.

Use the duct flanges provided on the supply- and return-air openings on the side of the unit. See Fig. 2 for connection sizes and locations. The 14-in. round duct collars are shipped inside the unit attached to the base pan in the indoor blower compartment. They

REQUIRED CLEARANCES TO COMBUSTIBLE MATL.	MILLIMETERS (IN)
TOP OF UNIT.....	0
BOTTOM OF UNIT.....	0
SIDE OF UNIT WITH DUCT OPENINGS.....	0
SIDE OF UNIT OPPOSITE DUCT OPENINGS.....	0

NEC. REQUIRED CLEARANCES.	MILLIMETERS (IN)
BETWEEN UNITS, POWER ENTRY SIDE.....	1066.8 (42.00)
UNIT AND UNGROUNDED SURFACES, POWER ENTRY SIDE.....	914.0 (36.00)
UNIT AND BLOCK OR CONCRETE WALLS AND OTHER GROUNDED SURFACES, POWER ENTRY SIDE.....	1066.8 (42.00)

REQUIRED CLEARANCE FOR SERVICING	MILLIMETERS (IN)
TOP OF UNIT.....	914.0 (36.00)
SIDE OF UNIT OPPOSITE DUCT OPENINGS.....	762.0 (30.00)
SIDE OF UNIT WITH POWER ENTRY.....	762.0 (30.00)
(EXCEPT FOR NEC REQUIREMENTS)	

NOTE: CLEARANCES MUST BE MAINTAINED TO PREVENT RECIRCULATION OF AIR FROM OUTDOOR FAN DISCHARGE. A REMOVABLE FENCE OR BARRICADE REQUIRES NO CLEARANCE.

DIMENSIONS IN [] ARE IN INCHES

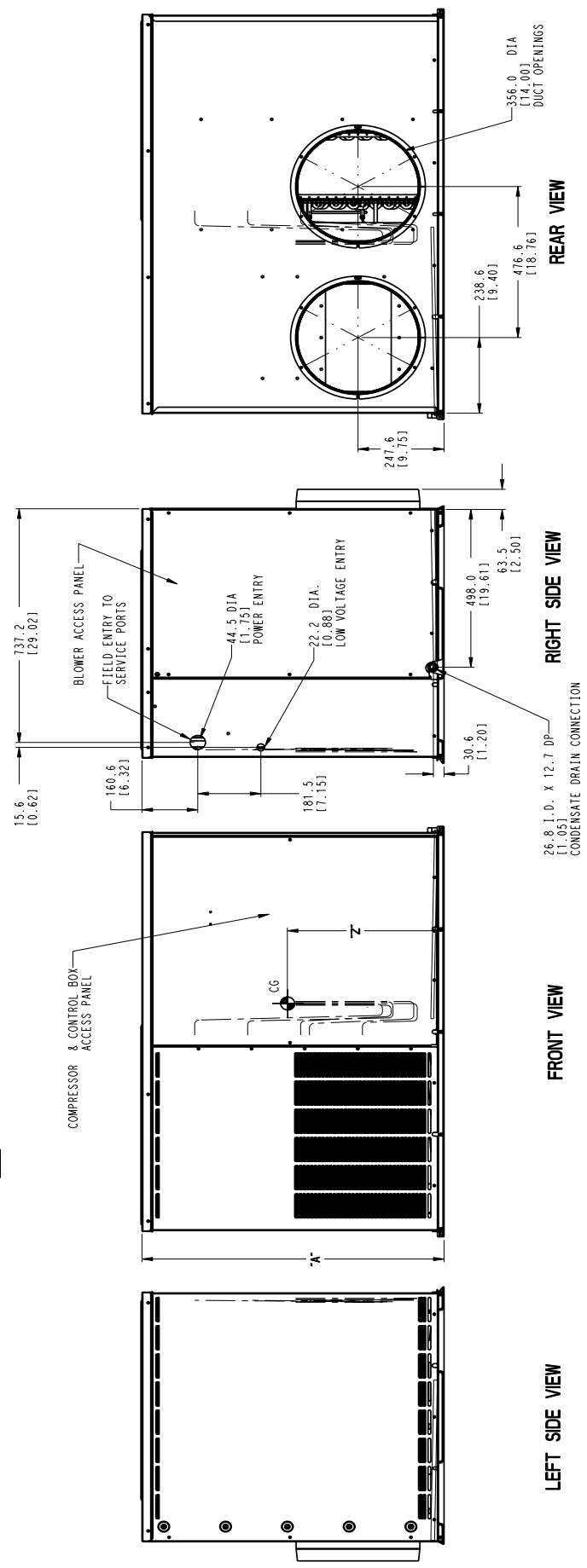
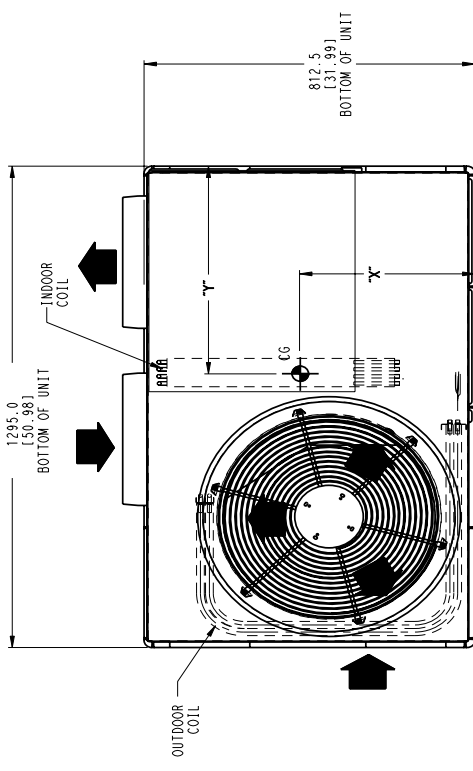

Fig. 2—Unit Base Dimensions, 50ZHA024-060

A05201

Table 1—Unit Specifications

UNIT	ELECTRICAL CHARACTERISTICS	UNIT WEIGHT		UNIT HEIGHT IN. (MM)	CENTER OF GRAVITY IN. (MM)		
		lb	kg	"A"	X	Y	Z
50ZHA024	208/230-1-60	293	133	30.13 (765)	14.0 (356)	19.0 (483)	12.0 (305)
50ZHA030	208/230-1-60	324	147	34.13 (867)	14.0 (356)	19.0 (483)	12.0 (305)
50ZHA036	208/230-1-60	377	171	42.13 (1070)	14.0 (356)	19.0 (438)	19.8 (503)
50ZHA042	208/230-1-60	389	177	42.13 (1070)	14.0 (356)	19.0 (483)	21.9 (556)
50ZHA048	208/230-1-60	384	175	42.13 (1070)	14.0 (356)	19.0 (483)	19.8 (503)
50ZHA060	208/230-1-60	433	197	42.13 (1070)	14.0 (356)	19.0 (483)	21.9 (556)

are field-installed and must be removed from the indoor blower compartment prior to start-up, even if they are not used for installation.

When designing and installing ductwork, consider the following:

⚠ CAUTION

UNIT DAMAGE HAZARD
Failure to follow this caution may result in damage to unit components. When connecting ductwork to units, do not drill deeper than 3/4 inch in shaded area shown in Fig. 3 or coil may be damaged.

- All units should have field-supplied filters installed in the return-air side of the unit. Recommended sizes for filters are shown in Table 2.
- Avoid abrupt duct size increases and reductions. Abrupt change in duct size adversely affects air performance.

IMPORTANT: Use flexible connectors between ductwork and unit to prevent transmission of vibration. Use suitable gaskets to ensure weathertight and airtight seal. When electric heat is installed, use fire proof canvas (or similar heat resistant material) connector between ductwork and unit discharge connection. If flexible duct is used, insert a sheet metal sleeve inside duct. Heat resistant duct connector (or sheet metal sleeve) must extend 24-in. from the unit discharge connection flange into the ductwork.

- Size ductwork for cooling air quantity (cfm). The minimum air quantity for proper electric heater operation is listed in Table 3. Heater limit switches may trip at air quantities below those recommended.
- Insulate and weatherproof all external ductwork. Insulate and cover with a vapor barrier all ductwork passing through conditioned spaces. Follow latest Sheet Metal and Air Conditioning Contractors National Association (SMACNA) and Air Conditioning Contractors Association (ACCA) minimum installation standards for residential heating and air conditioning systems.
- Secure all ducts to building structure. Flash, weatherproof, and vibration-isolate duct openings in wall or roof according to good construction practices.

Figure 4 shows a typical duct system with 50ZHA unit installed.
CONVERTING HORIZONTAL DISCHARGE UNITS TO DOWNFLOW (VERTICAL) DISCHARGE

⚠ WARNING

ELECTRICAL SHOCK HAZARD
Failure to follow this warning could result in personal injury or death.
Before performing service or maintenance operations on system, turn off main power to unit and install lockout tag. Turn off accessory heater power switch if applicable.

Units are dedicated side supply products. They are not convertible to vertical air supply. A field-supplied plenum must be used to convert to vertical air discharge.

Step 6—Provide for Condensate Disposal

NOTE: Be sure that condensate-water disposal methods comply with local codes, restrictions, and practices.

Unit removes condensate through a 1 3/64-in. ID hole (using 3/4-in. OD piping or tubing) which is located at the end of the unit. See Fig. 2 for location of condensate connection.

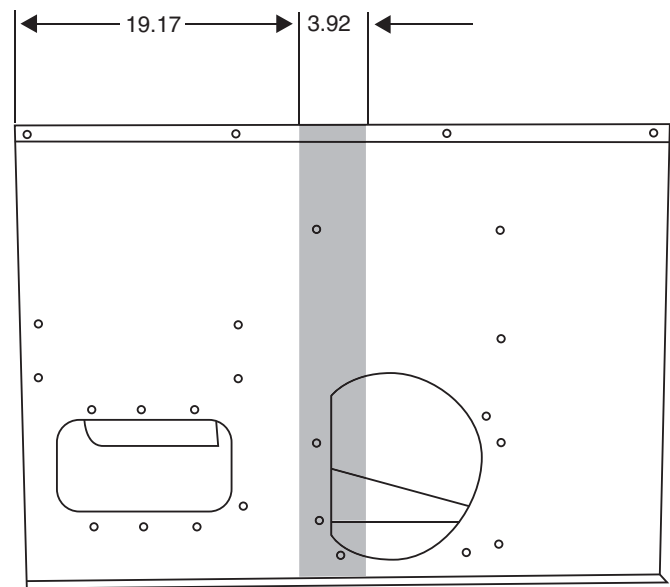

A05195

Fig. 3—Area Not to Be Drilled More Than 3/4-in.

Condensate water can be drained directly onto the roof in rooftop installations (where permitted) or onto a gravel apron in ground-level installations. Install a field-supplied condensate trap at end of condensate connection to ensure proper drainage. Make sure that the outlet of the trap is at least 1 in. lower than the drain-pan condensate connection to prevent the pan from overflowing. Prime the trap with water. When using a gravel apron, make sure it slopes away from the unit.

If the installation requires draining the condensate water away from the unit, install a 2-in. trap using a 3/4-in. OD tubing or pipe. (See Fig. 5 and 6.) Make sure that the outlet of the trap is at least 1 in. lower than the unit drain-pan condensate connection to prevent the pan from overflowing. Prime the trap with water. Connect a drain tube using a minimum of 3/4-in. PVC, 3/4-in. CPVC, or 3/4-in. copper pipe (all field supplied). Do not undersize the tube. Pitch the drain tube downward at a slope of at least 1 in. for every 10 ft of horizontal run. Be sure to check the drain tube for leaks. Prime trap at the beginning of the cooling season start-up. Allowable glues for condensate trap connection are: Standard ABS, CPVC, or PVC cement.

Table 2—Physical Data

UNIT 50ZHA	024	030	036	042	048	060
OPERATING WEIGHT (lbs)	293	324	377	389	384	433
COMPRESSOR TYPE	Scroll			Ultra Tech Scroll		
REFRIGERANT Charge (lb)	R-22					
	7.5	10.3	10.3	11.9	11.4	13.3
REFRIGERANT METERING DEVICE	Accurater			TXV		
	Orifice ID (in.)	.067	.067	.082	.086	—
Orifice OD (in.)	.049	.057	.059	.063	.070	.073
CONDENSER COIL	Copper Tubes, Aluminum Plate Fins					
	Rows...Fins/in.	2...21	2...21	2...21	2...21	2...21
Face Area (sq. ft.)	11.1	12.7	15.8	15.8	13.3	15.8
CONDENSER FAN	Propeller					
	Nominal Cfm	2600	2600	3200	3200	3200
Diameter (in.)	20	20	20	20	20	20
Motor HP (RPM)	1/8 (825)	1/8 (825)	1/4 (1100)	1/4 (1100)	1/4 (1100)	1/2 (1100)
EVAPORATOR COIL	Copper Tubes, Aluminum Plate Fins					
	Face Area (sq. ft.)	3...17	3...17	4...17	4...17	4...17
	4.3	4.9	4.9	6.1	4.9	6.1
Evaporator Blower	Direct Drive					
	Nominal Airflow (CFM)	800	1000	1200	1400	1600
Size (in.)	10 x 8	10 x 8	11 x 9	11 x 9	11 x 10	11 x 10
Motor HP (RPM)	1/2 (1050)	1/2 (1050)	3/4 (1050)	3/4 (1050)	1 (1050)	1 (1050)
CONNECTING DUCT SIZES	Round					
	Supply Air (in.)	14				
Return Air (in.)	14					
Return-Air Filters (in.)* Throwaway	24 x 24	24 x 24	24 x 24	24 x 30	30 x 30	30 x 30

*Required filter sizes shown are based on the ARI (Air Conditioning and Refrigeration Institute) rated airflow at a velocity of 300 ft/min for throwaway type or 450 ft/min for high capacity type. Recommended filters are 1-in. thick.

Step 7—Install Electrical Connections

⚠ WARNING

ELECTRICAL SHOCK HAZARD
 Failure to follow this warning could result in personal injury or death.
 The unit cabinet must have an uninterrupted, unbroken electrical ground to minimize the possibility of personal injury if an electrical fault should occur. This ground may consist of an electrical wire connected to the unit ground in the control compartment, or conduit approved for electrical ground when installed in accordance with NEC (National Electrical Code), ANSI (American National Standards Institute)/NFPA (latest edition) (in Canada, Canadian Electrical Code CSA C22.1) and local electrical codes.

⚠ CAUTION

UNIT DAMAGE HAZARD
 Failure to follow these precautions may result in damage to the unit being installed:

1. Make all electrical connections in accordance with NEC ANSI/NFPA (latest edition) and local electrical codes governing such wiring. In Canada, all electrical connections must be in accordance with CSA standard C22.1 Canadian Electrical Code Part 1 and applicable local codes. Refer to unit wiring diagram.
2. Use only *copper* conductor for connections between field-supplied electrical disconnect switch and unit. **DO NOT USE ALUMINUM WIRE.**
3. Be sure that high-voltage power to unit is within operating voltage range indicated on unit rating plate.
4. Insulate low-voltage wires for highest voltage contained within conduit when low-voltage control wires are run in same conduit as high-voltage wires.
5. Do not damage internal components when drilling through any panel to mount electrical hardware, conduit, etc. Consult local power company for correction of improper voltage.

HIGH-VOLTAGE CONNECTIONS

The unit must have a separate electrical service with a field-supplied, waterproof disconnect switch mounted at, or within sight from the unit. Refer to the unit rating plate for maximum fuse/circuit breaker size and minimum circuit amps (ampacity) for wire sizing. See Table 6 for electrical data.

The field-supplied disconnect may be mounted on the unit over the high-voltage inlet hole. (See Fig. 2.)

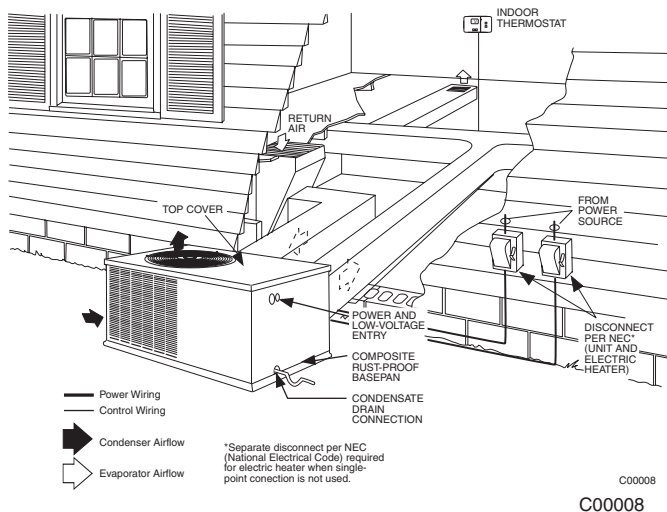

Fig. 4—Typical installation

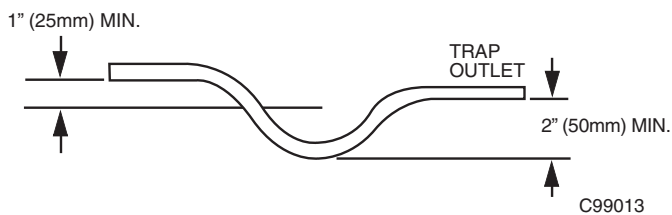

Fig. 5—Condensate Trap (Using Tubing)

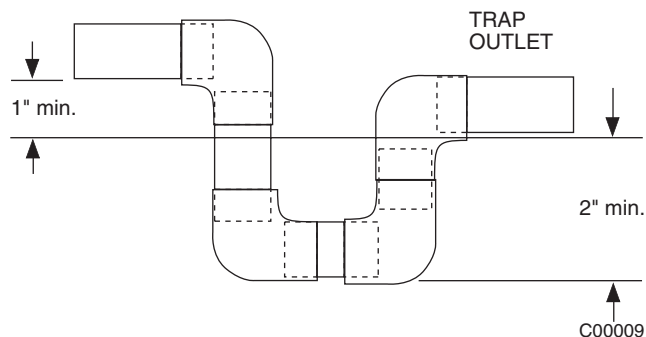

Fig. 6—PVC Condensate Trap

Table 3—Minimum Airflow for Safe Electric Heater Operation (CFM)

SIZE	024	030	036	042	048	060
Cfm	600	750	900	1050	1200	1500

CAUTION

UNIT DAMAGE HAZARD

Failure to follow this caution may result in unit component damage. Operation of unit on improper line voltage constitutes abuse and may cause unit damage that could affect warranty.

ROUTING POWER LEADS INTO UNIT

Use only copper wire between disconnect and unit. The high-voltage leads should be in a conduit until they enter the unit; conduit termination at the unit must be watertight. Run the high-voltage leads through the hole on the control box side of the unit (see Fig. 7 for location). When the leads are inside the unit, run leads to the control box (Fig. 8). For single-phase units, connect leads to the black and yellow wires (see Fig. 9).

CONNECTING GROUND LEAD TO UNIT GROUND

Refer to Fig. 8 and 9. Connect the ground lead to the chassis using the unit ground in the control box.

ROUTING CONTROL POWER WIRES

Form a drip-loop with the thermostat leads before routing them into the unit. Route the thermostat leads through grommetted hole provided in unit into unit control box (See Fig. 7). Connect thermostat leads and unit power leads as shown in Fig. 9, 10A & 10B.

Route thermostat wires through grommet providing a drip-loop at the panel. Connect low-voltage leads to the thermostat as shown in Fig. 10A & 10B.

The unit transformer supplies 24-v power for complete system including accessory electrical heater. Transformer is factory wired for 230-v operation.

ACCESSORY ELECTRIC HEAT WIRING

Refer to accessory electric heat installation instructions for information on installing accessory electric heat. Accessory electric heat wiring is shown in Fig. 11A, 11B, & 11C.

PRE-START-UP

WARNING

FIRE, EXPLOSION, ELECTRICAL SHOCK HAZARD
Failure to observe the following warnings could result in serious injury, death and/or property damage:

1. Follow recognized safety practices and wear protective goggles when checking or servicing refrigerant system.
2. Do not operate compressor or provide any electric power to unit unless compressor terminal cover is in place and secured.
3. Do not remove compressor terminal cover until all electrical sources are disconnected and lockout tag is installed.
4. Relieve all pressure from both high- and low-pressure sides of the system before touching or disturbing anything inside terminal box if refrigerant leak is suspected around compressor terminals. Use accepted methods to recover refrigerant.
5. Never attempt to repair soldered connection while refrigerant system is under pressure.
6. Do not use torch to remove any component. System contains oil and refrigerant under pressure. To remove a component, wear protective goggles and proceed as follows:
 - a. Shut off electrical power to unit and install lockout tag.
 - b. Relieve all refrigerant from system using both high- and low-pressure ports. Use accepted methods to recover refrigerant.
 - c. Cut component connecting tubing with tubing cutter and remove component from unit.
 - d. Carefully unsweat remaining tubing stubs when necessary. Oil can ignite when exposed to torch flame.

Use the Start-Up Checklist supplied at the end of this book and proceed as follows to inspect and prepare the unit for initial start-up:

1. Remove all access panels.
2. Read and follow instructions on all DANGER, WARNING, CAUTION, and INFORMATION labels attached to, or shipped with unit.

Make the following inspections:

- a. Inspect for shipping and handling damages such as broken lines, loose parts, disconnected wires, etc.

Table 4—Required Subcooling

REQUIRED SUBCOOLING °F (°C)					
Model Size	Outdoor Ambient Temperature				
	75 (24)	82 (28)	85 (29)	95 (35)	105 (41)
048	17.5 (9.7)	17 (9.4)	16.5 (9.2)	16 (8.9)	14 (7.8)
060	21 (11.7)	20.5 (11.4)	20 (11.1)	19 (10.6)	16 (8.9)

Table 5—Required Liquid Line Temperature

REQUIRED LIQUID LINE TEMPERATURE FOR A SPECIFIC SUBCOOLING (R-22)									
Pressure (psig)	Required Subcooling (°F)				Pressure (kPa)	Required Subcooling (°C)			
	5	10	15	20		3	6	8	11
134	71	66	61	56	924	24	22	19	16
141	74	69	64	59	972	26	23	21	18
156	80	75	70	65	1075	30	27	24	21
163	83	78	73	68	1124	31	28	26	23
170	86	81	76	71	1172	33	30	27	24
177	89	84	79	74	1220	34	31	29	26
184	91	86	81	76	1268	36	33	30	27
191	94	89	84	79	1317	37	34	31	29
198	96	91	86	81	1365	38	36	33	30
205	98	93	88	83	1413	40	37	34	31
213	101	96	91	86	1468	41	38	36	33
221	104	99	94	89	1524	43	40	37	34
229	106	101	96	91	1579	44	41	38	36
237	108	103	98	93	1634	45	42	40	37
245	111	106	101	96	1689	47	44	41	38
253	113	108	103	98	1744	48	45	42	40
262	116	111	106	101	1806	49	46	44	41
271	118	113	108	103	1868	51	48	45	42
280	121	116	111	106	1930	52	49	46	44
289	123	118	113	108	1992	53	51	48	45
298	125	120	115	110	2054	55	52	49	46
307	128	123	118	113	2116	56	53	50	48
317	130	125	120	115	2185	57	54	52	49
327	132	127	122	117	2254	59	56	53	50
337	135	130	125	120	2323	60	57	54	52
347	137	132	127	122	2392	61	58	56	53
357	139	134	129	124	2461	62	60	57	54
367	142	137	132	127	2530	64	61	58	55
280	121	116	111	106	1930	52	49	46	44
289	123	118	113	108	1992	53	51	48	45
298	125	120	115	110	2054	55	52	49	46
307	128	123	118	113	2116	56	53	50	48
317	130	125	120	115	2185	57	54	52	49
327	132	127	122	117	2254	59	56	53	50
337	135	130	125	120	2323	60	57	54	52
347	137	132	127	122	2392	61	58	56	53
357	139	134	129	124	2461	62	60	57	54
367	142	137	132	127	2530	64	61	58	55

- b. Inspect for oil at all refrigerant tubing connections and on unit base. Detecting oil generally indicates a refrigerant leak. Leak-test all refrigerant tubing connections using electronic leak detector, or liquid-soap solution. If a refrigerant leak is detected, see following Check for Refrigerant Leaks section.
 - c. Inspect all field- and factory-wiring connections. Be sure that connections are completed and tight. Ensure wires do not contact refrigerant tubing or sheet metal edges.
 - d. Inspect coil fins. If damaged during shipping and handling, carefully straighten fins with a fin comb.
3. Verify the following conditions:
 - a. Make sure that outdoor-fan blade is correctly positioned in fan orifice. Top edge of blade should be 3.125 in. down from outdoor coil outlet grille (size 024–048, See Fig. 12) or hub should be 0.708-in. away from motor end bell (size 060, See Fig. 13). See Outdoor Fan Adjustment section.
 - b. Make sure that air filter is in place.
 - c. Make sure that condensate drain trap is filled with water to ensure proper drainage.
 - d. Make sure that all tools and miscellaneous loose parts have been removed.

HIGH-VOLTAGE POWER WIRING ENTRY HOLE
LOW-VOLTAGE WIRING ENTRY HOLE

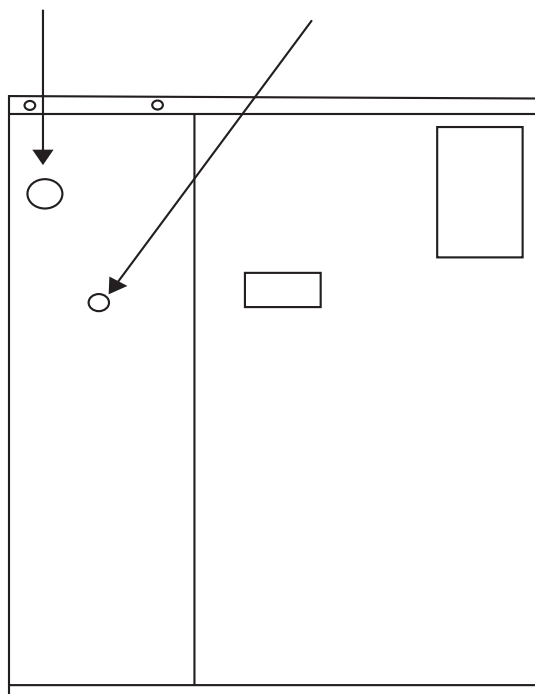

A05198

Fig. 7—Unit Electrical Connection

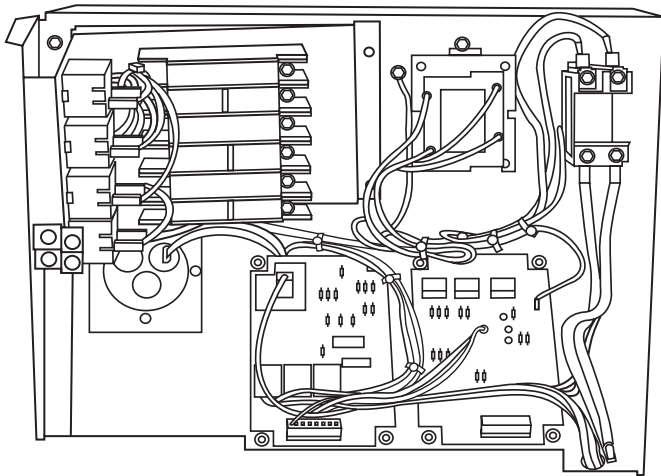

Fig. 8—Control Box Wiring

START-UP

Use the Start-Up Checklist supplied at the end of this book and proceed as follows:

Step 1—Check for Refrigerant Leaks

LOCATE AND REPAIR REFRIGERANT LEAKS AND CHARGE THE UNIT AS FOLLOWS:

1. Using both high- and low-pressure ports, locate leaks and reclaim remaining refrigerant to relieve system pressure.
2. Repair leak following accepted practices.

NOTE: Install a liquid-line filter drier whenever the system has been opened for repair.

Step 2—Start-Up Cooling Section and Make Adjustments

⚠ CAUTION

UNIT DAMAGE HAZARD
Failure to follow this caution may result in unit component damage.

Complete the required procedures given in the Pre-Start-Up section this page before starting the unit. Do not jumper any safety devices when operating the unit.

Do not operate the compressor in cooling mode when the outdoor temperature is below 40 F.

Do not rapid-cycle the compressor. Allow 5 minutes between “on” cycles to prevent compressor damage.

CHECKING COOLING CONTROL OPERATION

Start and check the unit for proper cooling control operation as follows:

1. Place room thermostat SYSTEM switch in OFF position. Observe that blower motor starts when FAN switch is placed in ON position and shuts down within 60 seconds (for 024-042) or 90 seconds (for 048 and 060) when FAN switch is placed in AUTO position.
2. Place SYSTEM switch in COOL position and FAN switch in AUTO position. Set cooling control below room temperature. Observe that compressor, outdoor fan, and indoor blower motors start and that reversing valve shifts. Observe that cooling cycle shuts down when control setting is satisfied. Reversing valve (RV) remains energized.
3. Place system switch in HEAT position. Observe that compressor, indoor fan and outdoor fan energize (Reversing Valve is deenergized in heat pump heating mode). Set control above room temperature. Observe that heating cycle shuts down when control setting is satisfied.
4. When using an automatic changeover room thermostat, place both SYSTEM and FAN switches in AUTO. positions. Observe that unit operates in Cooling mode when temperature control is set to “call for cooling” (below room temperature), and unit operates in Heating mode when temperature control is set to “call for heating” (above room temperature).

Step 3—Refrigerant Charge

Refrigerant Charge — Amount of refrigerant charge is listed on unit nameplate and in Table 2. Refer to Carrier Refrigerant Service Techniques Manual, Refrigerants section. Unit panels must be in place when unit is operating during charging procedure. Unit must operate a minimum of 15 minutes before checking charge.

NO CHARGE

Refer to Carrier Refrigerant Service Techniques. Use standard evacuating techniques. After evacuating system, weigh in the specified amount of refrigerant (refer to Table 2).

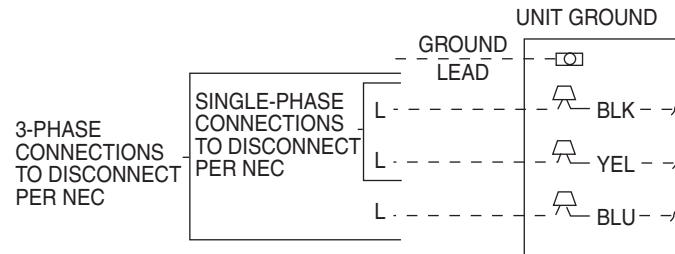

C00012

Fig. 9—Line Power Connections

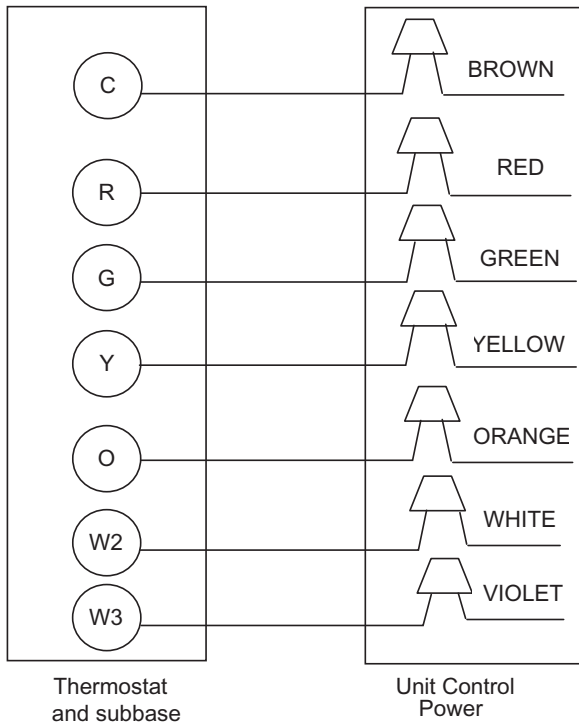

Fig. 10A—Control Connections (Sizes 024-042)

A05207

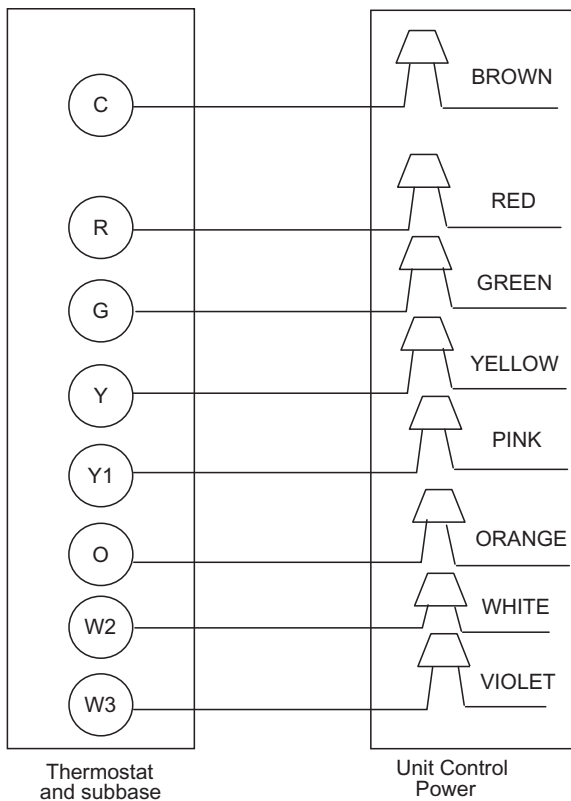

Fig. 10B—Control Connections (Sizes 048-060)

A05208

LOW CHARGE COOLING

024-042 units:

1. Measure suction line pressure by attaching a gauge to the service port.
2. Measure the suction line temperature by attaching a temperature sensing device to it.

3. Insulate the temperature sensing device so that the outdoor ambient doesn't affect the reading.
4. Locate the measured suction line pressure in the top row of Table 8 and the measured outdoor ambient temperature in the left column of the table. Based on the two values, determine the required suction line temperature.
5. If the measured suction line temperature is greater than the tabulated temperature, add charge in the system.

048 and 060 units:

1. Measure discharge line pressure by attaching a gauge to the service port.
2. Measure the liquid line temperature by attaching a temperature sensing device to it.
3. Insulate the temperature sensing device so that the outdoor ambient doesn't affect the reading.
4. Refer to the required subcooling in Tables 4 and 5 to find the required subcooling based on the model size and the outdoor ambient temperature.
5. Interpolate if the outdoor temperature lies in between the table values. Extrapolate if the temperature lies beyond the table range.
6. Find the pressure value corresponding to the measured pressure on the compressor discharge line.
7. Read across from the pressure reading to obtain the Liquid line temperature for a required subcooling.
8. Add charge if the measured temperature is higher than the liquid line temperature value in the table.
9. Add charge using the service connection on the suction line of the compressor.

HEATING MODE CHARGE

Do not attempt to adjust charge by cooling methods while in heat pump heating mode. Recover refrigerant and weigh in according to unit data plate refrigerant data.

Step 4—Indoor Airflow and Airflow Adjustments

NOTE: For cooling operation, the recommended airflow is 350 to 450 cfm per each 12,000 Btuh of rated cooling capacity.

Table 7 shows dry coil air delivery for horizontal discharge units. Tables 9-11 show pressure drops.

NOTE: Be sure that all supply- and return-air grilles are open, free from obstructions, and adjusted properly.

⚠ WARNING

ELECTRICAL SHOCK HAZARD
 Failure to follow this warning could result in personal injury or death.
 Disconnect electrical power to the unit and install lockout tag before changing blower speed.

Airflow can be changed by changing the 24 volts lead connections of the blower motor.

Unit 50ZHA blower motors are factory wired for rated airflow operation.

FOR 208/230-V BLOWER MOTORS

The motor lead speed connections are as follows:

SIZE	RATED AIRFLOW	HIGH AIRFLOW
024	Tap 1	Tap 3
030	Tap 2	Tap 4
036	Tap 1	Tap 3
042	Tap 2	Tap 4

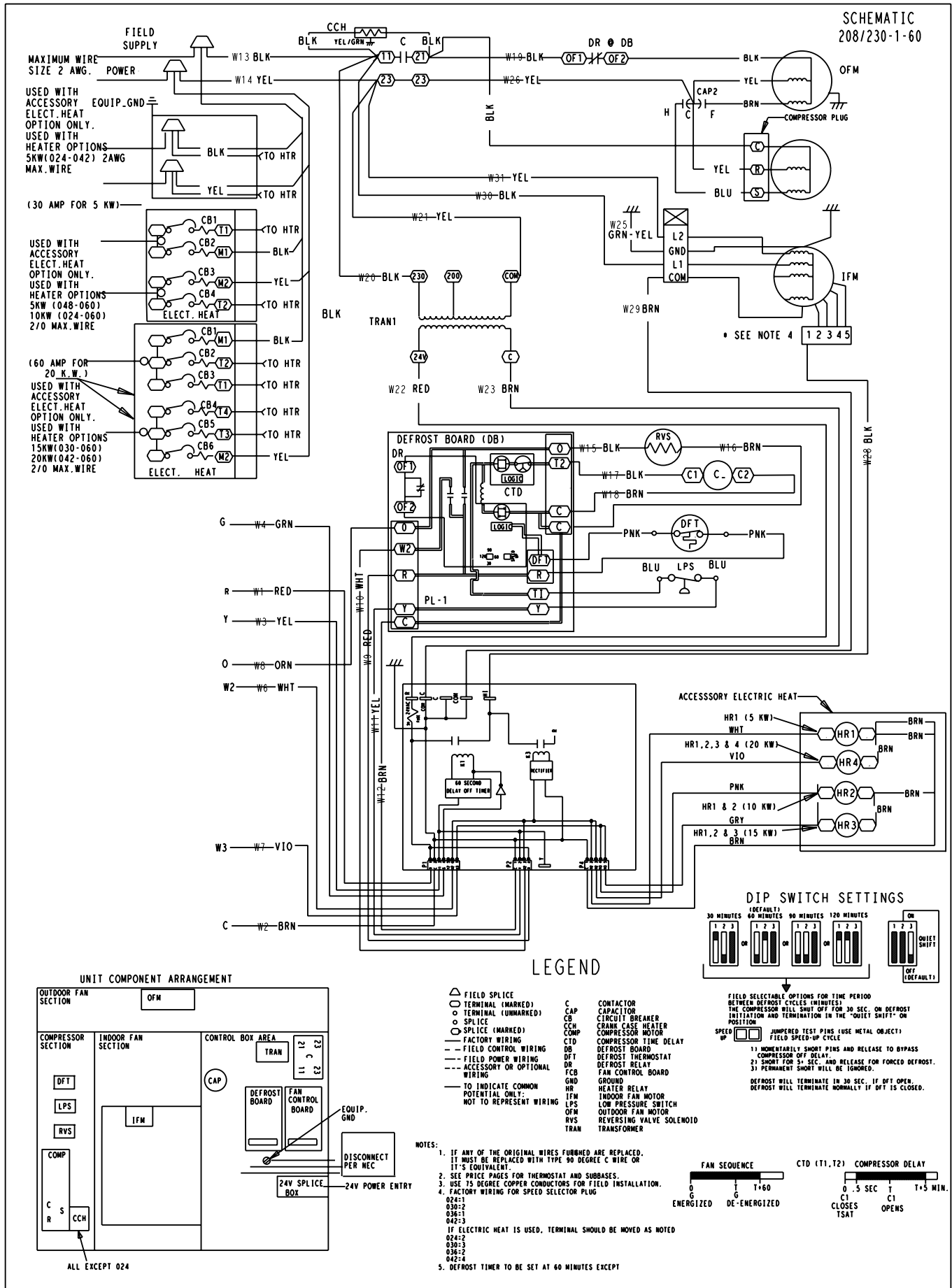

Fig. 11A—Typical Unit Electrical Diagram (Sizes 024-042)

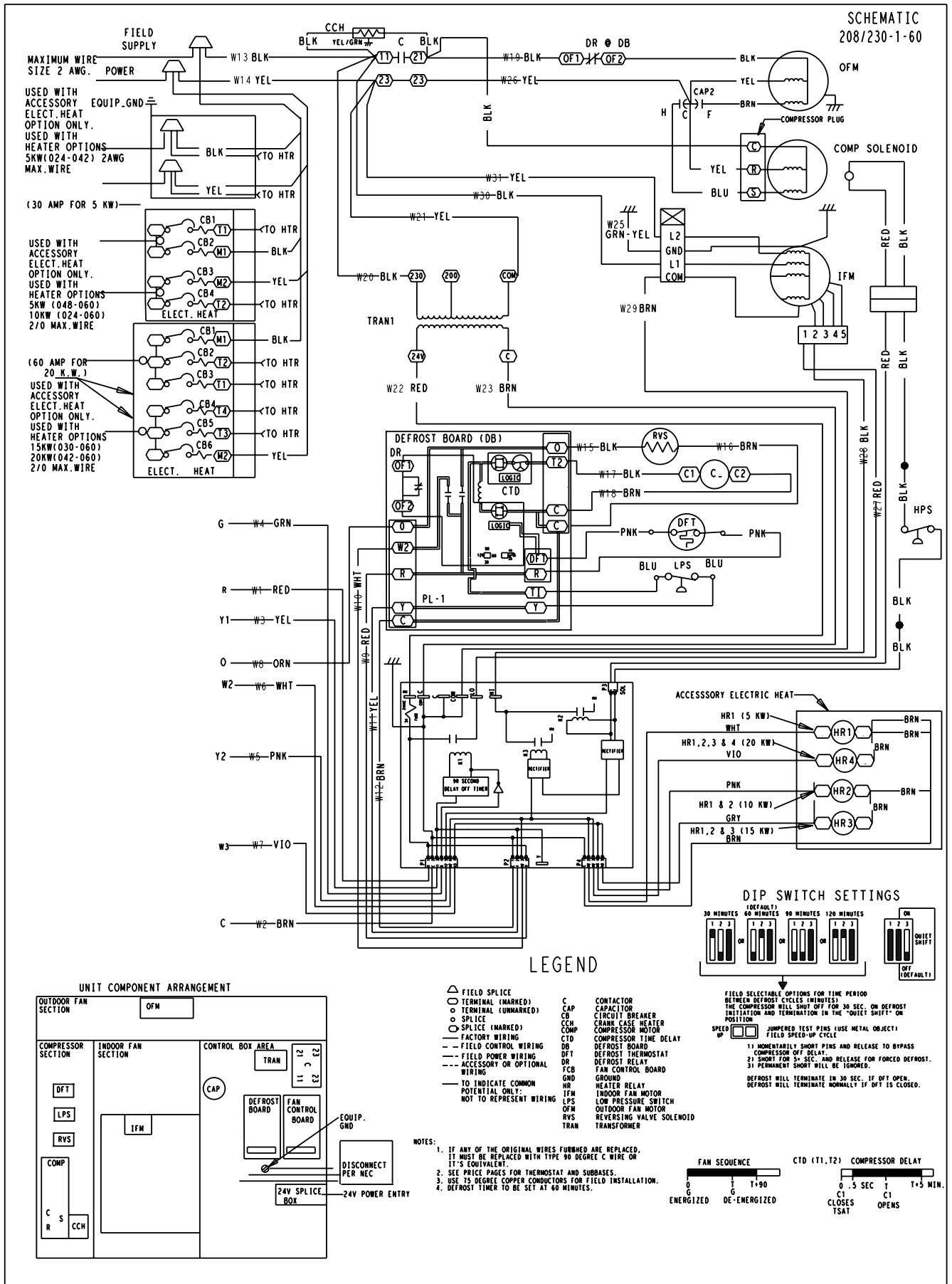
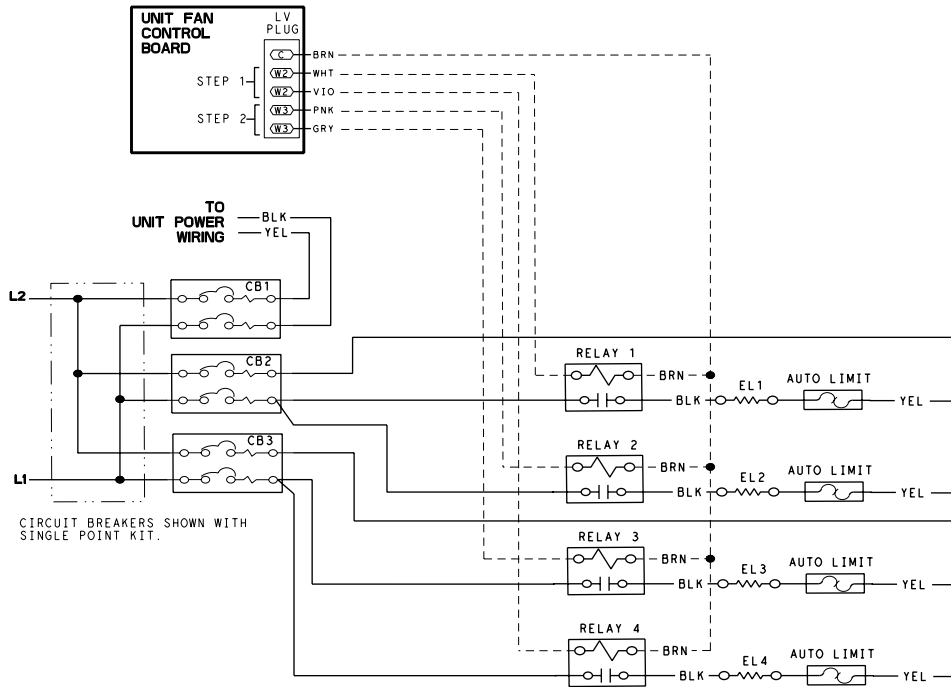

Fig. 11B—Typical Unit Electrical Diagram (Sizes 048-060)

A05200



A05209

Fig. 11C—Accessory Electric Heater Wiring

Table 6—Electrical Data—50ZHA

UNIT SIZE 50ZHA	V-PH-HZ	VOLTAGE RANGE		COMPRESSOR		OFM FLA	IFM FLA	ELECTRIC HEAT		SINGLE POINT POWER SUPPLY		
		MIN	MAX	RLA	LRA			Nominal KW*	FLA	MCA	FUSE OR CKT BKR	MOCP
024	208/230-1-60	187	253	10.9	54.0	0.9	4.1	—/—	—/—	18.6/18.6	25/25	—
								3.8/5.0	18.1/20.8	41.2/44.7	—	—
								7.5/10.0	36.1/41.7	63.8/70.7	—	60/70
								5.4/7.2	26.0/30.0	51.1/56.1	50/50	—
030	208/230-1-60	187	253	13.5	72.5	0.9	4.1	—/—	—/—	21.8/21.8	30/30	—
								3.8/5.0	18.1/20.8	44.4/47.9	—	—
								7.5/10.0	36.1/41.7	57.0/73.9	—	70/70
								11.3/15.0	54.2/62.5	89.5/100.0	—	90/100
036	208/230-1-60	187	253	17.5	88.0	1.5	6.0	—/—	—/—	29.4/29.4	35/35	—
								3.8/5.0	18.1/20.8	52.0/55.4	—	—
								7.5/10.0	36.1/41.7	74.5/81.5	—	80/80
								11.3/15.0	54.2/62.5	97.1/107.5	—	100/100
042	208/230-1-60	187	253	19.4	104.0	1.5	6.0	—/—	—/—	31.7/31.7	40/40	—
								3.8/5.0	18.1/20.8	54.3/57.8	—	60/70
								7.5/10.0	36.1/41.7	76.9/83.8	—	80/90
								11.3/15.0	54.2/62.5	99.4/109.9	—	100/110
048	208/230-1-60	187	253	24.7	116.0	1.5	7.7	—/—	—/—	40.0/40.0	50/50	—
								3.8/5.0	18.1/20.8	62.6/66.1	—	80/80
								7.5/10.0	36.1/41.7	85.1/92.1	—	100/100
								11.3/15.0	54.2/62.5	107.7/118.1	—	110/125
060	208/230-1-60	187	253	28.0	118.0	3.0	7.7	—	—/—	45.7/45.7	60/60	—
								3.8/5.0	18.1/20.8	68.2/71.7	—	90/90
								7.5/10.0	36.1/41.7	90.8/97.8	—	100/110
								11.3/15.0	54.2/62.5	113.4/123.8	—	125/125
060	208/230-1-60	187	253	28.0	118.0	3.0	7.7	15.0/20.0	72.2/83.3	135.9/149.9	—	125/150
								5.4/7.2	26.0/30.0	78.2/83.2	—	90/100

FLA Full Load Amps
 LRA Locked Rotor Amps
 MCA Minimum Circuit Amps
 MOCP Maximum Overcurrent Protection
 RLA Rated Load Amps



NOTES:

- In compliance with NEC (National Electrical Code) requirements for multimotor and combination load equipment (refer to NEC Articles 430 and 440), the overcurrent protective device for the unit shall be Power Supply fuse. The CGA (Canadian Gas Association) units may be fuse or circuit breaker.
- Minimum wire size is based on 60 C copper wire. If other than 60 C wire is used, or if length exceeds wire length in table, determine size from NEC.

**Table 7—Dry Coil Air Delivery* Horizontal Discharge
(Deduct 10 percent for 208 Volt Operation)**

50ZHA	SPEED TAP	WATTS/C.F.M	EXTERNAL STATIC PRESSURE									
			0.1	0.2	.03	0.4	0.5	0.6	0.7	0.8	0.9	1.0
024	1	Watts	-	99	100	118	130	142	-	-	-	-
		C.F.M.	-	848	793	757	698	632	-	-	-	-
	2	Watts	-	-	-	-	-	222	233	244	257	260
		C.F.M.	-	-	-	-	-	970	918	861	795	729
030	2	Watts	-	155	146	157	170	-	-	-	-	-
		C.F.M.	-	1108	995	951	884	-	-	-	-	-
	3	Watts	-	-	-	-	-	261	275	286	291	315
		C.F.M.	-	-	-	-	-	1117	1053	1014	980	877
036	1	Watts	180	166	179	191	204	216	-	-	-	-
		C.F.M.	1344	1215	1172	1136	1095	1051	-	-	-	-
	2	Watts	-	-	-	261	276	290	301	316	329	342
		C.F.M.	-	-	-	1343	1304	1272	1234	1190	1148	1100
042	3	Watts	269	283	305	321	336	349	360	-	-	-
		C.F.M.	1440	1404	1369	1333	1301	1273	1239	-	-	-
	4	Watts	-	-	418	432	450	465	480	490	503	518
		C.F.M.	-	-	1572	1543	1504	1475	1441	1418	1380	1332
048	1	Watts	—	204	209	216	229	236	249	—	—	—
		C.F.M.	—	1129	1087	1027	994	932	881	—	—	—
	2	Watts	—	—	233	245	254	266	276	289	—	—
		C.F.M.	—	—	1164	1122	1066	1025	954	906	—	—
	3	Watts	386	398	409	418	425	435	438	441	451	—
		C.F.M.	1680	1652	1625	1583	1555	1515	1477	1444	1403	—
	4	Watts	—	440	448	457	462	469	477	480	485	486
		C.F.M.	—	1745	1717	1684	1651	1612	1573	1537	1508	1470
060	1	Watts	224	235	251	266	277	291	298	-	-	-
		C.F.M.	1334	1288	1259	1224	1181	1157	1117	-	-	-
	2	Watts	-	-	286	301	311	325	333	344	370	-
		C.F.M.	-	-	1333	1296	1261	1232	1199	1170	1062	-
	3	Watts	608	626	643	660	668	685	697	-	-	-
		C.F.M.	1931	1900	1878	1844	1817	1789	1755	-	-	-
	4	Watts	737	755	770	787	799	817	826	812	782	-
		C.F.M.	2093	2061	2028	2001	1971	1934	1899	1850	1757	-

Air delivery values are based on operating voltage of 230-v., dry coil, without filter or electric heater. Deduct wet coil, filter, and electric heater pressure drops to obtain external static pressure available for ducting.
Do not operate the unit at a cooling airflow that is less than 350 cfm for each 12,000 Btuh of rated cooling capacity. Evaporator coil frosting may occur at airflows below this point.
Dashes indicate portions of the table that are beyond the blower motor capacity or are not recommended.

SIZE	RATED AIRFLOW		HIGH AIRFLOW	
	Low Stage	High Stage	Low Stage	High Stage
048	Tap 1	Tap 3	Tap 2	Tap 4
060	Tap 1	Tap 3	Tap 2	Tap 4

Step 5—Unit Controls

All compressors have the following internal-protection controls.

HIGH-PRESSURE RELIEF VALVE

This valve opens when the pressure differential between the low and high side becomes excessive.

LOSS OF CHARGE SWITCH

Located on the outdoor liquid line is a low-pressure switch which functions as a loss-of-charge switch. This switch contains a Schrader core depressor. This switch opens at 7 psig and closes at 22 psig. No adjustment is necessary.

COMPRESSOR OVERLOAD

This overload interrupts power to the compressor when either the current or internal temperature become excessive, and automatically resets when the internal temperature drops to a safe level.

This overload may require up to 60 minutes (or longer) to reset; therefore, if the internal overload is suspected of being open, disconnect the electrical power to the unit and check the circuit through the overload with an ohmmeter or continuity tester.

Step 6—Sequence of Operation

FAN OPERATION

The FAN switch on the thermostat controls indoor fan operation. When the FAN switch is placed in the ON position, the IFR (indoor-fan relay) is energized through the G terminal on the thermostat. The normally-open contacts close, which then provide power to the indoor (evaporator) fan motor (IFM). The IFM will run continuously when the FAN switch is set to ON.

When the FAN switch is set to AUTO, the thermostat deenergizes the IFR (provided there is not a call for cooling). The contacts open and the IFM is deenergized. The IFM will be energized only when there is a call for cooling, in heat pump heating mode or if the unit is equipped with accessory electric heat, the indoor-fan motor will also run while the accessory electric heat is energized.

NOTE: Some units are equipped with a time-delay relay. On these units, the indoor fan remains on for 30 seconds after G or Y is deenergized.

Table 8—Cooling Charging Chart

SUCTION LINE TEMPERATURE (°F)															
Suction Line Pressure (PSIG)															
OD Temp. (°F)	52	54	56	59	61	64	67	70	73	76	79	82	85	89	92
45	51	55	60	64	69	—	—	—	—	—	—	—	—	—	—
55	—	—	53	57	62	66	70	—	—	—	—	—	—	—	—
65	—	—	—	—	53	57	62	66	71	75	—	—	—	—	—
75	—	—	—	—	—	—	—	56	61	66	71	76	—	—	—
85	—	—	—	—	—	—	—	—	53	58	63	67	72	—	—
95	—	—	—	—	—	—	—	—	—	50	54	58	62	66	—
105	—	—	—	—	—	—	—	—	—	—	50	53	57	60	64
115	—	—	—	—	—	—	—	—	—	—	49	52	55	58	61
125	—	—	—	—	—	—	—	—	—	—	—	50	53	56	59

SUCTION LINE TEMPERATURE (°C)															
Suction Line Pressure (kPa)															
OD Temp. (°C)	361	370	387	405	423	442	462	482	502	523	544	566	589	612	636
7	11	13	15	18	21	—	—	—	—	—	—	—	—	—	—
13	—	—	12	14	16	19	21	—	—	—	—	—	—	—	—
18	—	—	—	—	12	14	17	19	21	24	—	—	—	—	—
24	—	—	—	—	—	—	—	13	16	19	22	24	—	—	—
29	—	—	—	—	—	—	—	—	12	14	17	20	22	—	—
35	—	—	—	—	—	—	—	—	—	10	12	14	17	19	—
41	—	—	—	—	—	—	—	—	—	—	10	12	14	16	18
46	—	—	—	—	—	—	—	—	—	—	9	11	13	14	16
52	—	—	—	—	—	—	—	—	—	—	—	10	11	13	15

COOLING OPERATION (SIZES 024-042)

With a call for cooling (Y/Y2), the indoor fan energizes immediately whereas the contactor energizes after a 5 minute time delay (in case of initial start-up) starting the compressor and the outdoor fan motor. When the cooling demand is met, Y/Y2 de-energizes, shutting the compressor, indoor fan and the outdoor fan.

COOLING OPERATION (SIZES 048 AND 060)

These units utilize a 2 stage indoor thermostat. With a first stage call for cooling (Y1), the indoor fan (low stage) energizes immediately whereas the contactor energizes after a 5 minute time delay (in case of an initial start-up) starting the compressor (low stage) and the outdoor fan motor. If the low stage operation cannot satisfy the cooling demand, the second stage cooling (Y2) energizes switching the compressor into high stage cooling through energizing an internal solenoid valve inside the scroll compressor and switching the indoor fan into high stage. When second stage cooling is satisfied, Y2 de-energizes switching the compressor and the indoor fan into low stage cooling. When the low stage cooling demand is met, Y1 de-energizes shutting the compressor, indoor fan and the outdoor fan.

HEATING OPERATION (SIZES 024-042)

With a call for heating (Y1), the indoor fan (low stage) energizes immediately whereas the contactor energizes after a 5 minute time delay (in case of initial start-up) starting the compressor and the outdoor fan motor. If Y/Y2 cannot satisfy the heating demand, the auxiliary or backup heat (W2) energizes. In case of staged heating, W3 is energized if the demand is not met. The highest airflow selected is run while the electric heat is in operation. When heating demand is met, W3, W2 and Y/Y2 sequentially de-energize shutting the compressor, indoor fan and the outdoor fan.

HEATING OPERATION (SIZES 048 AND 060)

With a first stage call for heating (Y1), the indoor fan (low stage) energizes immediately whereas the contactor energizes after a 5 minute time delay (in case of initial start-up) starting the compressor (low stage) and the outdoor fan motor. If the low stage operation cannot satisfy the heating demand, the second stage

heating (Y2) energizes switching the compressor into high stage heating through energizing an internal solenoid valve inside the scroll compressor and switching the indoor fan into high stage. The auxiliary or backup heat is controlled by a third stage (W2). If the demand is not met, W3 is energized in case of staged heating. When heating demand is satisfied, W3, W2 and Y2 sequentially de-energize switching the compressor and the indoor fan into low stage heating. When the low stage heating demand is met, Y1 de-energizes shutting the compressor, indoor fan and the outdoor fan.

CONTINUOUS FAN

With the continuous Indoor fan option selected on the thermostat, G is continuously energized. In case of 024-042 units, the selected airflow setting is provided. In case of 048 and 060 units, the system runs low stage (Y1) airflow for continuous fan operation.

DEFROST

Defrost board (DB) is a time and temperature control, which includes a field-selectable time period between checks for defrost (30, 60, 90 and 120 minutes). The time period is factory-set at 60 minutes and should only be adjusted by a trained service person. Electronic timer and defrost cycle start only when contactor is energized and defrost thermostat (DFT) is closed.

Defrost mode is identical to Cooling mode. The outdoor fan motor stops because of “OF1” and “OF2” contacts opening on the defrost board, a bank of optional electric heat turns on to warm air supplying the conditioned space.

ELECTRIC RESISTANCE HEATING

If accessory electric heaters are installed, on a call for “Emergency Heat” the thermostat energizes W which energizes the heater relay and in turn energizes the electric heaters. The IFR is energized which starts the indoor-fan motor. If the heaters are staged, W2 is energized when the second stage of heating is required. When the need for heating is satisfied, the heater and IFM are de-energized.

MAINTENANCE

To ensure continuing high performance, and to reduce the possibility of premature equipment failure, periodic maintenance must

be performed on this equipment. This cooling unit should be inspected at least once each year by a qualified service person. To troubleshoot cooling of units, refer to Troubleshooting chart in back of book.

NOTE TO EQUIPMENT OWNER: Consult your local dealer about the availability of a maintenance contract.

⚠ WARNING

FIRE, EXPLOSION, ELECTRICAL SHOCK HAZARD
Failure to follow this warning could result in personal injury, death or property damage.
The ability to properly perform maintenance on this equipment requires certain expertise, mechanical skills, tools and equipment. If you do not possess these, do not attempt to perform any maintenance on this equipment, other than those procedures recommended in the User's Manual.

The minimum maintenance requirements for this equipment are as follows:

1. Inspect air filter(s) each month. Clean or replace when necessary.
2. Inspect indoor coil, outdoor coil, drain pan, and condensate drain each cooling and heating season for cleanliness. Clean when necessary.
3. Inspect blower motor and wheel for cleanliness each cooling and heating season. Clean when necessary. For first heating season, inspect blower wheel bimonthly to determine proper cleaning frequency.
4. Check electrical connections for tightness and controls for proper operation each cooling season. Service when necessary.
5. Check the drain channel in the top cover periodically for blockage (leaves, insects). Clean as needed.

⚠ WARNING

FIRE, EXPLOSION, ELECTRICAL SHOCK, CUT HAZARD
Failure to follow these warnings could result in serious personal injury, death, and/or property damage:
1. Turn off electrical power to the unit and install lockout tag before performing any maintenance or service on the unit.
2. Use extreme caution when removing panels and parts. As with any mechanical equipment, personal injury can result from sharp edges, etc.
3. Never place anything combustible either on, or in contact with, the unit.

Step 1—Air Filter

NOTE: Never operate the unit without a suitable air filter in the return-air duct system. Always replace the filter with the same size as originally installed. See Table 2 for recommended filter sizes.

Inspect air filter(s) at least once each month and replace (throwaway-type) or clean (cleanable-type) at least twice during each cooling season or whenever the filters become clogged with dust and lint.

Replace filters with the same dimensional size and type as originally provided, when necessary.

Step 2—Unit Top Removal (Outdoor-Coil Side)

NOTE: When performing maintenance or service procedures that require removal of the unit top, be sure to perform all of the routine maintenance procedures that require top removal, including coil inspection and cleaning, and condensate drain pan inspection and cleaning.

⚠ WARNING

ELECTRICAL SHOCK HAZARD
Failure to follow this warning could result in personal injury or death.
Disconnect and tag electrical power to the unit before removing top.

Only qualified service personnel should perform maintenance and service procedures that require unit top removal.

Refer to the following top removal procedures:

1. Remove screws on unit top cover surface. (Save all screws.)
2. Remove screws on unit top cover flange. (Save all screws.)
3. Lift top from unit carefully. Set top on edge and make sure that top is supported by unit side that is opposite duct (or plenum) side.
4. Carefully replace and secure unit top to unit, using screws removed in Steps 1 and 2, when maintenance and/or service procedures are completed.

Step 3—Indoor Blower and Motor

For longer life, operating economy, and continuing efficiency, clean accumulated dirt and grease from the blower wheel and motor annually.

⚠ WARNING

ELECTRICAL SHOCK HAZARD
Failure to follow this warning could result in personal injury or death.
Disconnect and tag electrical power to the unit before cleaning the blower wheel.

To clean the blower wheel follow the following steps:

1. Remove the blower housing:
 - a. Remove the screws on the external side of the duct panel that fasten the housing to the duct panel assembly.
 - b. Remove the side access panel and unscrew the mounting bracket that fastens the blower housing to the internal partition panel of the control box assembly.
 - c. Make sure that the blower housing is supported by hand before completely removing the mounting bracket.
 - d. Slide the blower housing from the rails of the duct panel and place it outside the unit.
2. Remove the blower wheel from the housing:
 - a. Loosen the set screw which secures the wheel to the motor shaft.
 - b. Loosen the three mounting legs of the motor by removing the bolts that fasten them to the housing.
 - c. Slide out the motor assembly (motor, belly band and the 3 mounting legs) from the hub of the wheel.
 - d. Remove the filler panel at the discharge end of the blower housing by removing the two screws that fasten it to the housing.
 - e. Remove the wheel from the housing.
3. Remove the caked on dirt from the wheel and the motor using a brush.
4. Remove lint and dirt accumulations from the wheel and housing with a vacuum cleaner, using a soft brush attachment.
5. Remove grease and oil with a mild solvent.
6. Reassemble

Table 9—Wet Coil Pressure Drop

UNIT SIZE	STANDARD CFM (S.C.F.M.)														
	600	700	800	900	1000	1100	1200	1300	1400	1500	1600	1700	1800	1900	2000
024	.027	.034	.040	.047	.053	-	-	-	-	-	-	-	-	-	-
030	-	.036	.042	.050	.055	.063	.072	.081	-	-	-	-	-	-	-
036	-	-	-	.050	.055	.063	.072	.081	.090	.097	-	-	-	-	-
042	-	-	-	-	.042	.049	.052	.059	.065	.071	.078	.085	.091	-	-
048	-	-	-	-	-	-	.072	.081	.090	.097	.108	.120	.129	.139	-
060	-	-	-	-	-	-	-	-	-	.071	.078	.085	.091	.098	.114

- Slip the wheel back in the housing with the hub set screw parented in the correct direction.
- Install the filler panel.
- Reinsert the motor assembly in the wheel hub and align the mounting legs with the housing mounting hold locations.
- Tighten the mounting bolts to fasten the motor assembly with the housing.
- Center the wheel in the housing by sliding it, align the flat end of the shaft with the set screw and tighten the set screw.
- Slide back the blower housing into the mounting rails in the duct panel and install the mounting bracket back in its position.
- Install the screws on the external side of the duct panel to fasten duct panel with the housing.
- Replace the side access panel.

Step 4—Outdoor Coil, Indoor Coil, and Condensate Drain Pan

Inspect the outdoor coil, indoor coil, and condensate drain pan at least once heating and cooling season. Proper inspection and cleaning requires the removal of the unit top. See Unit Top Removal section.

Table 10—Filter Pressure Drop (in. wg)

UNIT SIZE	FILTER SIZE (IN.)	CFM									
		500	600	700	800	900	1000	1100	1200	1300	1400
024-036	24 x 24	0.06	0.07	0.08	0.08	0.09	0.09	0.09	0.10	0.11	0.12
042-060	30 x 30	-	-	-	-	-	-	-	-	0.08	0.09

UNIT SIZE	FILTER SIZE (IN.)	CFM								
		1500	1600	1700	1800	1900	2000	2100	2200	2300
024-036	24 x 24	0.14	0.15	-	-	-	-	-	-	-
042-060	30 x 30	0.10	0.11	0.12	0.13	0.14	0.15	0.16	0.17	0.18

Table 11—Accessory Electric Heat Pressure Drop (in. wg)

HEATER KW 5-20	CFM									
	600	800	1000	1200	1400	1600	1800	2000	2200	2500
	0.06	0.08	0.10	0.13	0.15	0.18	0.20	0.23	0.25	

Remove all obstructions (including weeds and shrubs) that interfere with the airflow through the outdoor coil. Straighten bent fins with a fin comb. If coated with dirt or lint, clean the coils with a vacuum cleaner, using a soft brush attachment. Be careful not to bend the fins. If coated with oil or grease, clean the coils with a mild detergent-and-water-solution. Rinse coils with clear water, using a garden hose. Be careful not to splash water on motors, insulation, wiring or air filter(s). For best results, spray outdoor-

coil fins from inside to outside the unit. On units with an outer and inner outdoor coil, be sure to clean between the coils. Be sure to flush all dirt and debris from the unit base.

Inspect the drain pan and condensate drain line when inspecting the coils. Clean the drain pan and condensate drain by removing all foreign matter from the pan. Flush the pan and drain tube with clear water. Do not splash water on the insulation, motor, wiring, or air filter(s). If the drain tube is restricted, clear it with a ‘‘plumbers snake’’ or similar probe device. Ensure that the auxiliary drain port above the drain tube is also clear.

Step 5—Outdoor Fan

⚠ CAUTION

UNIT OPERATIONAL HAZARD
 Failure to follow this caution may result in damage to unit components.
 Keep the Outdoor fan free from all obstructions to ensure proper cooling operation. Never place articles on top of the unit.

- Shut off unit power supply and install lockout tag.
- Remove outdoor-fan assembly (grille, motor, motor cover, and fan) by removing screws and flipping assembly onto unit top cover.
- Loosen fan hub setscrews.
- Adjust fan height as shown in Fig. 12 or 13.
- Tighten setscrews.
- Replace outdoor-fan assembly.

Step 6—Electrical Controls and Wiring

Inspect and check the electrical controls and wiring annually. *Be sure to turn off the electrical power to the unit and install lockout tag.*

Remove the top panel to locate all the electrical controls and wiring. Check all electrical connections for tightness. Tighten all screw connections. If any smoky or burned connections are noticed, disassemble the connection, clean all the parts, restrip the wire end and reassemble the connection properly and securely.

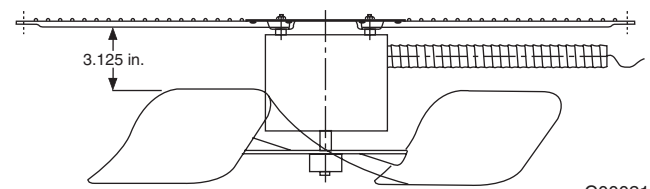

C00021

Fig. 12—Outdoor-Fan Adjustment (024–048 Size)

Check to ensure no wires are touching refrigerant tubing or sharp sheet metal edges. Move and secure wires to isolate from tubing and sheet metal edges.

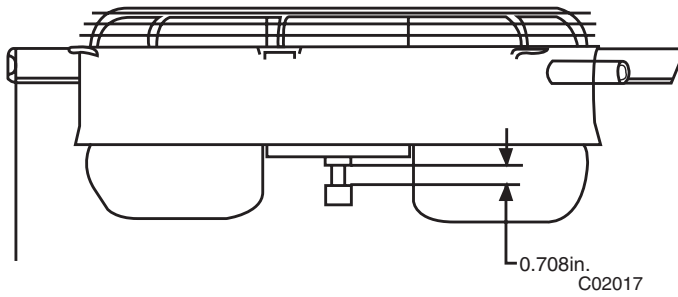

Fig. 13—Outdoor-Fan Adjustment (060 Size)

After inspecting the electrical controls and wiring, replace all the panels. Start the unit, and observe at least one complete cooling cycle to ensure proper operation. If discrepancies are observed in operating cycle, or if a suspected malfunction has occurred, check each electrical component with the proper electrical instrumentation. Refer to the unit wiring label when making these checkouts.

NOTE: Refer to the Sequence of Operation section, as an aid in determining proper control operation.

Step 7—Refrigerant Circuit

Inspect all refrigerant tubing connections and the unit base for oil accumulations annually. Detecting oil generally indicates a refrigerant leak.

If oil is detected or if low cooling performance is suspected, leak-test all refrigerant tubing using an electronic leak-detector, or liquid-soap solution. If a refrigerant leak is detected, refer to Check for Refrigerant Leaks section. (See Table of Contents for page number.)

If no refrigerant leaks are found and low cooling performance is suspected, refer to Refrigerant Charge. (See Table of Contents for page number.)

Step 8—Indoor Airflow

The cooling airflow does not require checking unless improper performance is suspected. *If a problem exists, be sure that all supply- and return-air grilles are open and free from obstructions,*

and that the air filter is clean. When necessary, refer to Indoor Airflow and Airflow Adjustments section to check the system airflow.

Step 9—Metering Devices

Refrigerant cooling metering device is an Accurater (024-042) or TXV (048 and 060) located upstream of the indoor coil distributor assembly. Refrigerant heating mode metering device is an Accurater located upstream of the outdoor coil distributor assembly.

Step 10—Lubrication

COMPRESSOR—The compressor is charged with the correct amount of oil at the factory.

FAN MOTOR BEARINGS—Fan motor bearings are permanently lubricated. No further lubrication of outdoor or indoor fan motors is required.

Step 11—Liquid Line Strainer

The liquid line strainer (to protect metering device) is made of wire mesh and is located in the liquid line on the inlet side of the metering device.

Check valves are also located in the liquid lines near the strainers. The Strainers are the larger of the two components.

Step 12—High Flow Valves

Located on the compressor hot gas and suction tubes are High Flow Valves. Large black plastic caps distinguish these valves with O-rings located inside the caps. These valves cannot be accessed for service in the field. Ensure the plastic caps are in place and tight or the possibility of refrigerant leakage could occur.

TROUBLESHOOTING

Use the Troubleshooting Cooling and Heating guide if problems occur with these units.

START-UP CHECKLIST

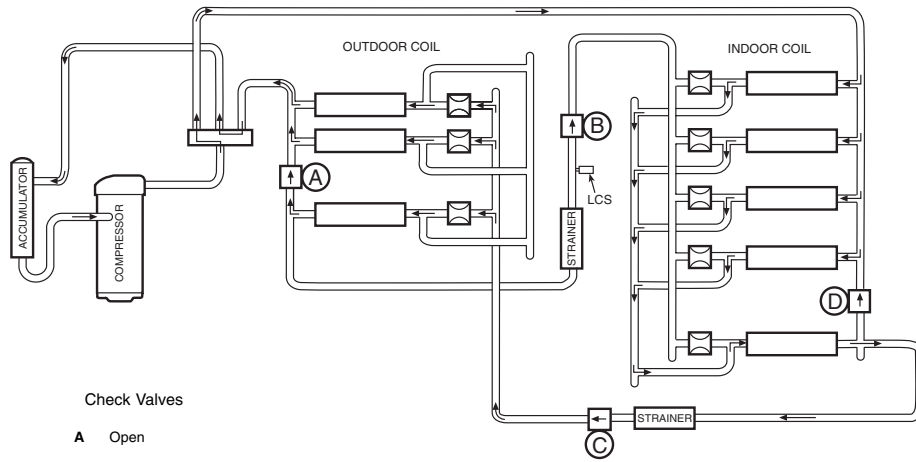

Use the Start-Up checklist to ensure proper start-up procedures are followed.



Check Valves

- A Open
- B Closed
- C Open
- D Closed

LEGEND

- LCS** Loss of Charge Switch
-  Acutrol Metering Device
-  Check Valve (Arrow indicates direction of flow)

HEATING CYCLE

1. Hot gas from compressor flows through the 4-way valve and is directed to the cooling liquid line check valve. It is then condensed and directed through subcooling circuits and out to the strainer and the check valve in the heating liquid line.
2. The refrigerant then feeds the outdoor coil through the Acutrol metering device on each circuit.
3. Each circuit evaporates the refrigerant and the circuits are combined in the outdoor header with some of the circuits flowing through the check valve.
4. The refrigerant then flows through the 4-way valve, accumulator, and back to the compressor.

C95045

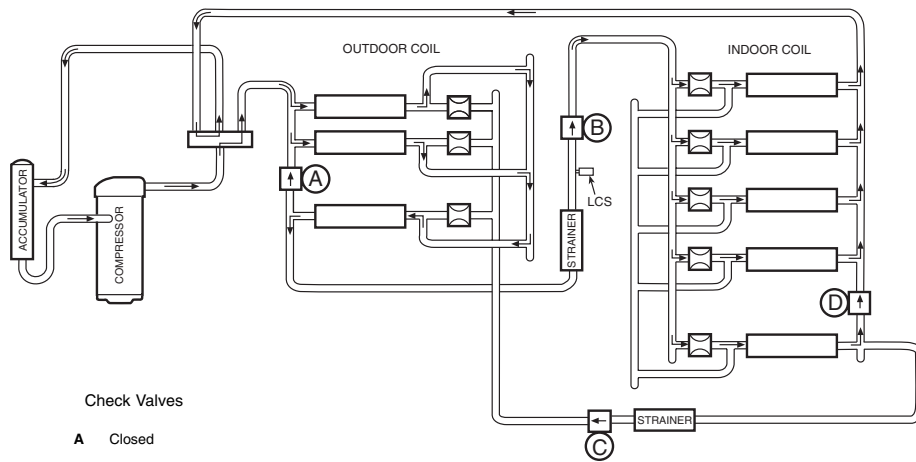

Fig. 14—Typical Heat Pump Operation, Heating Mode



Check Valves

- A Closed
- B Open
- C Closed
- D Open

LEGEND

- LCS** Loss of Charge Switch
-  Acutrol Metering Device
-  Check Valve (Arrow indicates direction of flow)

COOLING CYCLE

1. Hot gas from compressor flows through the 4-way valve and is directed to the heating liquid line check valve. It is then condensed and subcooled through converging circuits. Refrigerant leaves the outdoor coil by way of the strainer and the check valve in the cooling liquid line.
2. The refrigerant then feeds the indoor coil through the Acutrol metering device on each circuit.
3. Each circuit evaporates the refrigerant and the circuits are combined in the indoor coil header with some of the circuits flowing through the check valve.
4. The refrigerant then flows through the 4-way valve, accumulator, and back to the compressor.

C95044

Fig. 15—Typical Heat Pump Operation, Cooling Mode

Table 12—Troubleshooting—Cooling and Heating

SYMPTOM	CAUSE	REMEDY
Compressor and outdoor fan will not start.	Power Failure	Call power company
	Loss of Charge Switch open	Evaluate unit for possible refrigerant leak
	Fuse blown or circuit breaker tripped	Replace fuse or reset circuit breaker
	Defective thermostat, contractor, transformer, or control relay	Replace component
	Insufficient line voltage	Determine cause and correct
	Incorrect or faulty wiring	Check wiring diagram and rewire correctly
	Thermostat setting too high	Lower thermostat setting below room temperature
Compressor will not start but outdoor fan runs.	Faulty wiring or loose connections in compressor circuit	Check wiring and repair or replace
	Compressor motor burned out, seized, or internal overload open	Determine cause Replace compressor
	Defective run/start capacitor, overload, start relay	Determine cause and replace
	Low input voltage (20 percent low)	Determine cause and correct
Compressor cycles (other than normally satisfying thermostat).	Refrigerant overcharge or undercharge	Recover refrigerant, evacuate system, and recharge to capacities shown on nameplate
	Loss of Charge Switch open	Evaluate unit for possible refrigerant leak
	Defective compressor	Replace and determine cause
	Insufficient line voltage	Determine cause and correct
	Blocked outdoor coil (cooling)	Determine cause and correct
	Defective run/start capacitor, overload or start relay	Determine cause and replace
	Defective thermostat	Replace thermostat
	Faulty outdoor-fan motor or capacitor	Replace
Compressor operates continuously.	Restriction in refrigerant system	Locate restriction and remove
	Dirty air filter	Replace filter
	Unit undersized for load	Decrease load or increase unit size
	Thermostat set too low	Reset thermostat
	Low refrigerant charge	Locate leak, repair, and recharge
	Leaking valves in compressor	Replace compressor
	Frosted outdoor coil with incorrect defrost operation (heating)	Check defrost time settings. Reset as necessary. Check defrost temperature switch. Replace as necessary.
	Air in refrigerant system	Recover refrigerant, evacuate system, and recharge
Excessive head pressure.	outdoor coil dirty or restricted	Clean coil or remove restriction
	Dirty air filter	Replace filter
	Dirty outdoor coil	Clean coil
	Refrigerant overcharged	Recover excess refrigerant
	Air in refrigerant system	Recover refrigerant, evacuate system, and recharge
Head pressure too low.	Outdoor or indoor air restricted or air is recirculating	Determine cause and correct
	Low refrigerant charge	Check for leaks, repair and recharge
	Compressor valves leaking	Replace compressor
Excessive suction pressure.	Restriction in liquid tube	Remove restriction
	High heat load	Check for source and eliminate
	Compressor valves leaking	Replace compressor
Suction pressure too low.	Refrigerant overcharged	Recover excess refrigerant
	Dirty air filter (cooling)	Replace Filter
	Low refrigerant charge	Check for leaks, repair, and recharge
	Metering device or low side restricted	Remove source of restriction
	Insufficient indoor airflow (cooling)	Increase air quantity Check filter- replace if necessary
	Temperature too low in conditioned area (cooling)	Reset thermostat
	Outdoor ambient below 40°F (cooling)	Install low-ambient kit
Compressor runs but outdoor fan does not.	Field-installed filter-drier restricted	Replace
	Normally closed contacts on defrost board open	Check condition of relay on board. Replace board if necessary.

**START-UP CHECKLIST
(REMOVE AND STORE IN JOB FILE)**

I. PRELIMINARY INFORMATION

Model No
Serial No
Date
Technician
Customer Information(Name/Address)

II. PRE-START-UP

- Verify that all packing materials have been removed from unit
- Verify that condensate connection is installed per installation instructions
- Check all electrical connections and terminals for tightness
- Check wire proximity to refrigerant tubes and sheet metal edges
- Check that indoor (indoor) air filter is clean and in place
- Verify that unit installation is level
- Check fan wheel propeller for location in housing and setscrew tightness

III. START-UP

Supply Voltage: L1-L2 _____ L2-L3 _____ L3-L1 _____
Compressor Amps: L1(C) _____ L2(S) _____ L3(R) _____
Indoor Fan Amps: _____ Outdoor Fan Amps: _____

TEMPERATURE-Cooling Mode

Outdoor Air Temperature: _____ DB _____ WB
Return-Air Temperature: _____ DB _____ WB
Cooling Supply Air: _____ DB _____ WB

PRESSURES-Cooling Mode

Refrigerant Suction _____ psig
Suction Line Temp* _____
Refrigerant Discharge _____ psig
Discharge Temp† _____

TEMPERATURE-Heating Mode

Outdoor Air Temperature: _____ DB _____ WB
Return-Air Temperature: _____ DB _____ WB
Cooling Supply Air: _____ DB _____ WB

PRESSURES-Heating Mode

Refrigerant Suction _____ psig
Suction Line Temp* _____
Refrigerant Discharge _____ psig
Discharge Temp† _____

Verify Refrigerant charge using charging tables

*Measured at suction inlet to compressor
†Measured at liquid line leaving outdoor coil

Free Manuals Download Website

<http://myh66.com>

<http://usermanuals.us>

<http://www.somanuals.com>

<http://www.4manuals.cc>

<http://www.manual-lib.com>

<http://www.404manual.com>

<http://www.luxmanual.com>

<http://aubethermostatmanual.com>

Golf course search by state

<http://golfingnear.com>

Email search by domain

<http://emailbydomain.com>

Auto manuals search

<http://auto.somanuals.com>

TV manuals search

<http://tv.somanuals.com>