

Mason Air AS8800

Low air loss/Alternating pressure mattress

Instruction Manual

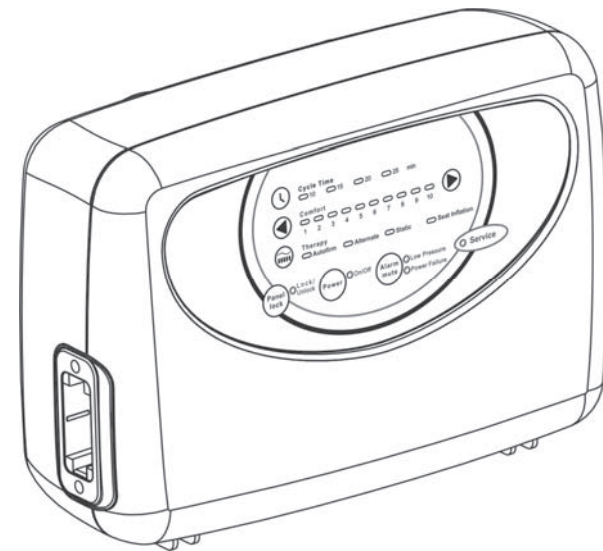

driveTM

Drive Medical Design & Manufacturing

99 Seaview Boulevard

Port Washington, NY 11050

Toll Free: 877-224-0946

Local: 516-998-4600

www.drivemedical.com

REV2.12.17.13

526001-5150 V1.2
Download from www.Somanuals.com. All Manuals Search And Download.

PLEASE READ ALL INSTRUCTIONS BEFORE USE.

Contents

Important Safeguards	2
Introduction	3
Product Description	4
Installation	7
Operation	9
Cleaning	11
Storage	11
Maintenance	12
Technical Description	13

SAVE THESE INSTRUCTIONS GROUNDING INSTRUCTIONS

This product should be grounded. In the event of an electrical short circuit grounding reduces the risk of electric shock by providing an escape wire for the electric current. This product is equipped with a cord having a grounding wire with a grounding plug. The plug must be plugged into an outlet that is properly installed and grounded.

DANGER - Improper use of the grounding plug can result in a risk of electric shock.

If repair or replacement of the cord or plug is necessary, do not connect the grounding wire to either flat blade terminal. The wire with insulation having an outer surface that is green with or without yellow stripes is the grounding wire.

NOTE - If the repair or replacement of the cord is necessary, please contact a qualified electrician or serviceman. To reduce the risk of electric shock, do not modify the cord or plug in any way.

Check with a qualified electrician or serviceman if the grounding instructions are not completely understood, or if in doubt as to whether the product is properly grounded.

8. TECHNICAL DESCRIPTION

Specifications:

Item		Specification
Power Supply (Note: See rating label on the product)		AC 120V 50/60 Hz, 0.17A (for 120V system) AC 230V 50/60 Hz, 0.07A (for 230V system)
Fuse Rating		T1A, 250V
Cycle time		Four selectable
Dimension (L x W x H)		29.1 x 20 x 11.7 (cm) or 11.4" x 7.9" x 4.6"
Weight		2.2 Kg or 5 lb
Environment	Temperature	Operation: 10° C to 40° C (50° F to 104° F) Storage: -15° C to 50° C (5° F to 122° F) Shipping: -15° C to 70° C (5° F to 158° F)
	Humidity	Operation: 10% to 90% non-condensing Storage: 10% to 90% non-condensing Shipping: 10% to 90% non-condensing
Classification		Class II with functional earth (NOTE: 5)*, Type BF, IPX0 Applied Part: Air Mattress Not suitable for use in the presence of a flammable anesthetic mixture (No AP or APG protection)
Mattress		Specification
Model		8" Mattress
Dimension (L x W x H)		200 x 90 x 20.3 (cm) or 78.7" x 35.4" x 8"
Weight		7.5 kg or 16.5 lb

- NOTE:**
1. Consult the distributor or EU representative for further technical documents.
 2. The specification is also suitable for other areas operating with same power supply.
 3. Mattress dimension and weight is measured without foam cushion
 4. The manufacturer reserves the right to modify the specification without notice.
 5. The earthing terminal is served as functional earth, not protective earth. (for UL only)

IMPORTANT SAFEGUARDS READ ALL INSTRUCTIONS BEFORE USING

DANGER - To reduce the risk of electrocution:

1. Always unplug this product immediately after using.
2. Do not use while bathing.
3. Do not place or store product where it can fall or be pulled into a tub or sink.
4. Do not place in or drop into water or other liquid.
5. Do not reach for a product that has fallen into water. Unplug immediately.

WARNING - To reduce the risk of burns, electrocution, fire, or injury to persons:

1. This product should never be left unattended when plugged in.
2. Close supervision is necessary when this product is used by, on, or near children or invalids.
3. Use this product only for its intended use as described in this manual. Do not use attachments not recommended by the manufacturer.
4. Never operate this product if it has a damaged cord or plug, if it is not working properly, if it has been dropped or damaged, or dropped into water. Return the product to a service center for examination and repair.
5. Keep the cord away from heated surfaces.
6. Never block the air openings of this product or place it on a soft surface, such as a bed or couch, where their openings may be blocked. Keep the air opening free of lint, hair, and other similar particles.
7. Never drop or insert any object into any opening or hose.
8. Connect this product to a properly grounded outlet only. See Grounding Instructions.

NOTE, CAUTION AND WARNING STATEMENTS:

NOTE - Indicate some tips.

CAUTION - Indicate correct operating or maintenance procedures in order to prevent damage to or destruction of the equipment or other property.

WARNING - Calls attention to a potential danger that requires correct procedures or practices in order to prevent personal injury.

SYMBOLS



"BF" symbol, indicate this product is according to the degree of protecting against electric shock for type BF equipment.



Grounding terminal (for 230V system)



Functional earth. (for UL only)



Attention, should read the instructions!



Disposal of Electrical & Electronic Equipment (WEEE):

This product should be handed over to an applicable collection point for the recycling of electrical and electronic equipment. For more detailed information about the recycling of this product, please contact your local city office, household waste disposal service or the retail store where you purchased this product.



Class II (for UL only)

1. INTRODUCTION

This manual should be used for initial set up of the system and for reference purposes.

1.1 GENERAL INFORMATION

The system is a high quality and affordable mattress system suitable for stage I, II, III, bed sore treatment and prevention of pressure ulcers.

The system has been tested and successfully approved with the following standards:

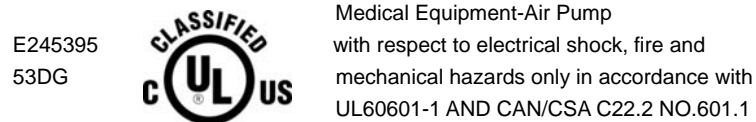
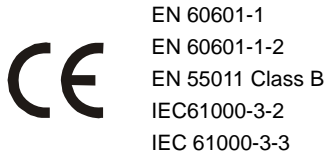

Le produit à été testé avec des équipements médicaux et respecte les normes UL 60601-1 & CAN/CSA C22.2 No.601.1. prévenant les choc électrique, le feu et les risques de blessures physiques.

1.2 INTENDED USE

This product is intended to help and reduce the incidence of pressure ulcers while optimizing patient comfort. It also provide following purposes:

- Individual home care setting and long-term care of whom suffering from pressure ulcer.
- Pain management as prescribed by physician.

NOTE: Equipment not suitable for use in the presence of a flammable anesthetic mixture with air or with oxygen or nitrous oxide.

NOTE: L'équipement ne peut être utilisé s'il y a risque de mélange d'un anesthésique inflammable avec l'air ou l'oxygène ou oxyde nitreux.

7. MAINTENANCE

7.1 GENERAL

1. Check main power cord and plug if there are abrasions or excessive wears.
2. Check mattress cover for signs of wear or damage. Ensure mattress cover and tubes are stubbed together correctly.
3. Check airflow from the air hose connector. The airflow should alternate between each connector every half-cycle time if it's in alternating mode.
4. Check the air hoses for any kink or break. For replacement, please contact our local dealers.

7.2 FUSE REPLACEMENT

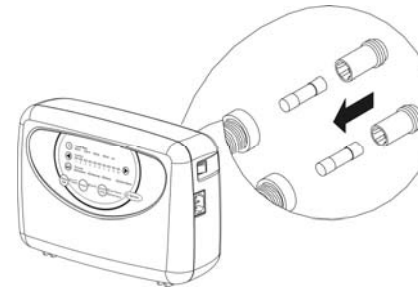

1. Disconnect the plug from mains power when a blown fuse is suspected.
2. Remove the cover of the fuse holder by means of a small screwdriver.
3. Insert a new fuse of the correct rating in, and replace the cover of the fuse holder back. The fuse should be rated as T1A/250V type and VDE approved.

7.3 AIR FILTER REPLACEMENT

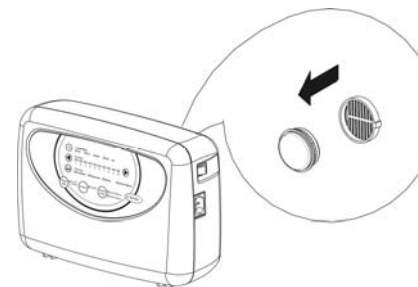

1. Loosen the screws from the air filter plate located at the back of pump.
2. The filter is reusable and can be washed gently with a mild detergent and water. Dry the filter before use.
3. Check and replace air filter regularly if environment is dirty.

5. CLEANING

It is important to follow the cleaning procedures before using the machine on human bodies; otherwise, patients and/or doctors may have the possibility of getting infection.

By wiping the pump unit with a damp cloth pre-soaked with a mild detergent, and keep it away from dust. If other detergent is used, choose one that will have no chemical effects on the surface of the plastic case of the pump unit.

CAUTION: Do not immerse or soak pump unit.

By wiping the mattress unit with a damp cloth pre-soaked with warm water (not to exceed 65 °C) containing a mild detergent, and keep it away from dust. The cover may also be cleaned using sodium hypochlorite diluted in water. All parts should be air dried thoroughly before use.

CAUTION: Do not use phenolic-based product for cleaning.

CAUTION: After cleaning, dry the mattress without direct exposure of sunlight.

The carrying bag (if available) should be turned inside out and completely wiped down using the disinfectant solutions. Allow it to air-dry thoroughly. Once the inside is dry, turn it back and wipe down the outside of the bag with disinfectant solutions.

6. STORAGE

1. To store, lay the mattress out flat and upsides down.
2. Roll from the head end towards the foot end.
3. Foot-end strap can then be stretched around the rolled mattress to prevent unrolling.

Note: Do not fold, crease or stack the mattresses.

2. PRODUCT DESCRIPTION

2.1 PUMP AND MATTRESS SYSTEM

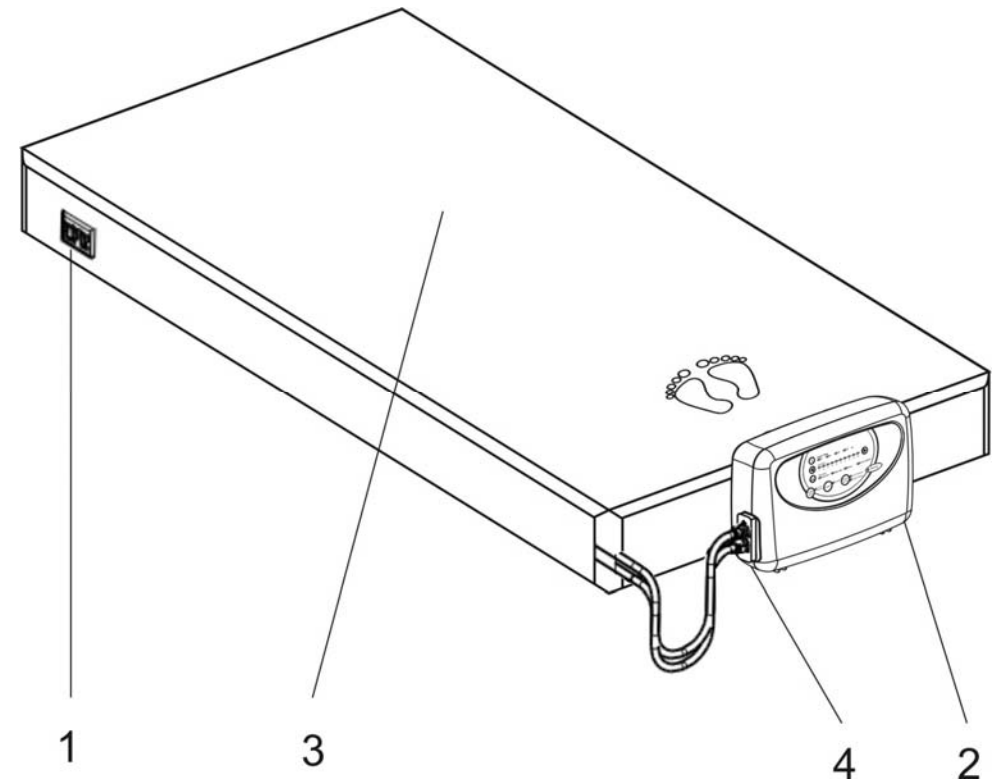

1. CPR
2. Pump unit
3. Mattress System
4. Quick Connectors

2.2 PUMP UNIT



Front

1. Quick Connectors
2. Front Panel

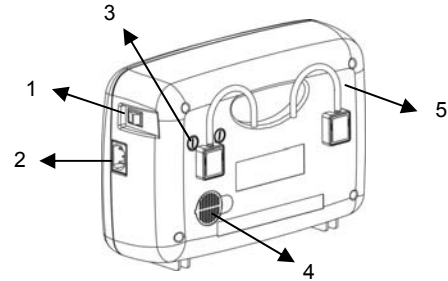

Rear

1. Power Switch
2. Power Cord
3. Fuses
4. Air Filter
5. Mounting Brackets

2.3 FRONT PANEL

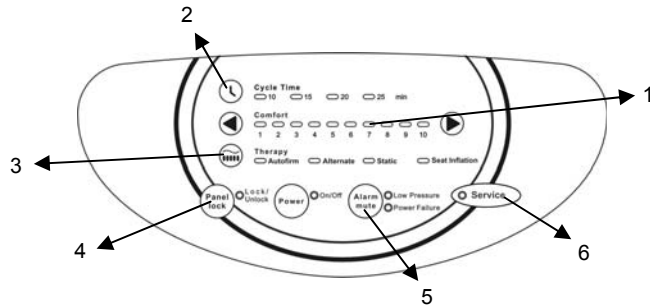

1. Pressure Adjust Levels

Pressure adjust levels controls the air pressure output. When turning up (▶), the output pressure will increase. Vice versa (◀) for decreasing air pressure. Higher-pressure output will support the heavier weight patient. In order to find the correct pressure setting: First inflate the patient to max pressure level, have the patient lie on top of the mattress, then decrease the pressure gradually until the patient feel most comfortable without bottoming out. Have the caregiver insert palm facing up and place between patient's buttock's area and static cell. Should the palm able to touch patient's buttock, increase the pressure until the skin is least 1/2" inch away from the palm. Always leave at least 1" inch space between patient's buttock areas to the static cell under to prevent bottoming out.

4.3 PRESSURE SET UP

Users can adjust pressure of air mattress to a desired softness by adjusting the comfort keys by weight. Please consult your physician for a suitable setting.

Patient can lie on the mattress after the pump is running under the alternating mode, this indicates the pressure is reached to the desired softness.

NOTE: Check to see if the suitable pressure is selected by sliding one hand between the deflated air cells and the patient to feel patient's buttocks. Users should be able to feel the minimum contact.

4.4 LOW PRESSURE INDICATION FUNCTION

When an abnormal low pressure occurred, the Low Pressure indicator (yellow LED) will light up along with the buzzer. Check to ensure all connections are connected properly and that they are correctly installed as per installation instructions.

NOTE: If the pressure level is consistently low, check for any leakage (tubes or connecting hoses). If necessary, replace any damaged tubes or hoses. Or contact local qualified dealer for repair.

The Low Pressure indicator will light up until the low-pressure fault condition is resolved.

4.5 STATIC MODE

Press the blue STATIC button to suspend the alternating mode of mattress. By pressing this button again, the mattress will be back to alternating therapy mode.

4.6 ALARM MUTE

When low-pressure situation occurred, both the LED light and buzzer will sound off to warn the patient. By pressing the button, it will temporary mute the buzzer so the care giver may check for possible air leaks. Should the situation not resolved within 5 minutes, the alarm will resume to beep.

4. OPERATION

 **NOTE:** Always read the operating instruction before use.

4.1 GENERAL OPERATION

1. Switch on the main power switch found from the side of the pump.
2. The pump unit is to delivering air into mattress, wait least 20 minutes for mattress to be inflated.
3. The low-pressure indicator (yellow LED) will light up when the mattress is not fully inflated.
4. When the appropriate pressure is reached, the low-pressure indicator (yellow LED) will go off and pump will enter the alternating mode.



- . According to the weight and height of the patient, adjust the pressure setting to the most comfortable level without bottoming out, then the pressure in mattress will slowly increase to a certain value after the air mattress is ready to use.

 **NOTE:** Every time when mattress is first setup for use, it is recommended that the pressure knob to be set to "Max" for the quickest inflation. User can then adjust air mattress to the desired softness afterward.

4.2 CPR

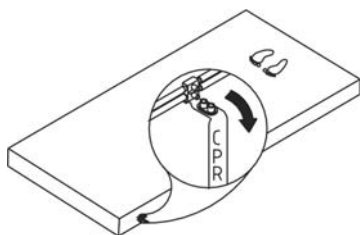

When there is an emergency to perform CPR on the patient, quickly pull the CPR valves to release air from mattress. The CPR valves are located at the head-end, right-hand-side of the mattress. The quick connector found from the pump unit can be disconnected for even faster deflation.

2. Cycle Time

There are four selectable cycle times found from the touch panel area. By pressing (icon) sign, user can select four different cycle times for best comfort.

3. Therapy.

A. Autofirm

This mode will be forced to execute every time the power switch is turned on. This insures the pump is able to reach its maximum operating pressure. Once the max pressure level is reached, the pump will automatically switch into alternating mode. User can also use this function as full mattress inflation during ingress/egress the patient for better support.

B. Alternate

There are four selectable cycle time available. User can select for best comfort.

C. Static.

Press STATIC button to suspend alternating function, if needed. The pressure inside of air tubes will be adjusted to the same softness. Press the STATIC button again; it will switch back to alternating mode. Under the static mode, cell pressure level will be lowered compare to the same pressure level from alternating mode. This special feature is to protect high-risk pressure sore patient from receiving additional pressure, which could lead to pressure sore risks. There is a 20 mins auto-recovery mode back to alternating cycle to ensure patient always getting best therapy possible.

D. Seat Inflation

The seat inflation features additional supports to the patient during upright position without bottoming out. User can select this additional feature under either static or alternate mode.

4. Panel Lock

Should the panel remain untouched for 3 minutes, the panel lock feature will lock the panel with green LED light on to prevent accident from changing the setting during normal operation. To unlock, simply by pressing the Panel lock button for 3 second to unlock.

5. Alarm Mute

Press alarm mute button to temporary suspend the low-pressure alarm (LED light and buzzer). Should the situation not resolved within 5 mins, the alarm shall resume to notify the patient.

A. PFA (Power Failure Alarm)

During power failure situation, the Power Failure LED light will lit on with buzzer. By pressing the mute button to disable both buzzer and LED.

B. Low Pressure Indicator

When low pressure LED lights up, the pressure inside of air mattress is below normal. Please refer to troubleshooting.

6. Service

This feature will lit during mechanical failure situation. User can notify the technician for repair.

3. INSTALLATION

Unpacking the box to inspect for any damage, which may have occurred during shipment. If there are any damages, please contact your dealer immediately.

3.1 PUMP & MATTRESS INSTALLATION

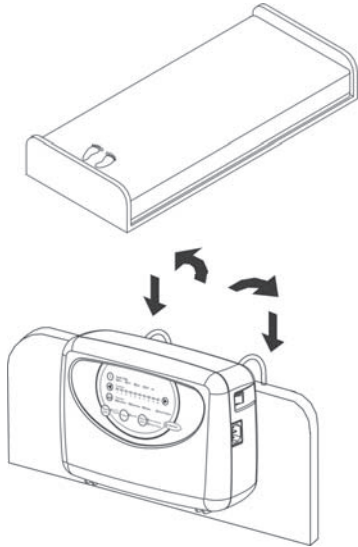

1. Place the mattress or pad on top of the bed frame. Please note for the foot end.

It is recommended to use this mattress system with a bed frame with adequate side rails to prevent falling.

2. Hang the pump onto bed rail (foot-end), and adjust hangers to best upright position of the pump, or place the pump on a flat surface.
3. Connect air hose connectors from air mattress to the pump unit. When a "click" sound is felt or heard, the connection is completed and secured.

NOTE: Check and ensure the air hoses are not kinked or tucked under mattress.

4. Plug the power cord into electrical outlet.

NOTE: 1. Make sure the pump unit is suitable for the local power voltage.
2. The plug is also served to disconnect the device.

NOTE: 1. S'assure que la pompe est compatible au voltage local ou disponible.
2. L'appareil est également muni d'une fiche de connexion à l'électricité.

CAUTION: The pump can only be applied to the mattress recommended by the manufacturer. Do not use it for any other purpose. (applied part: air mattress)

AVERTISSEMENT : La pompe ne peut être utilisée qu'avec le matelas designé ou r recommandé par le manufacturrier,. Ne pas server d'ysage autre que celui auquel elle a été conçu

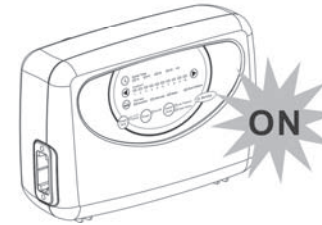
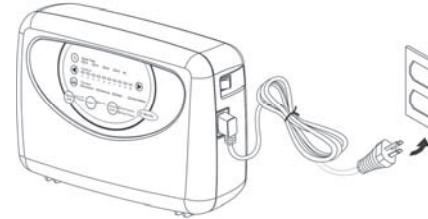
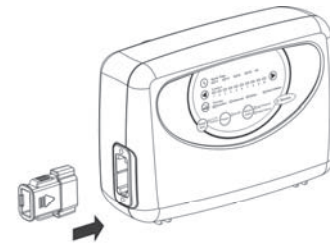

5. Then turn the main power switch to ON position.

Grounding:

Before any connection to the output connectors is made, the unit shall be connected to a protective earth conductor via the three-core main cable; the mains plug shall be inserted only into a socket outlet provided with a protective earth contact. The protective action shall not be negated by the user of an extension cord without protective conductor.

Several installation tips are listed below:

After installation, the extra length of the power cord, if any, should be neatly arranged to avoid any tripping accidents. The EQUIPMENT should be firmly placed at position where users/doctors can access easily.

Free Manuals Download Website

<http://myh66.com>

<http://usermanuals.us>

<http://www.somanuals.com>

<http://www.4manuals.cc>

<http://www.manual-lib.com>

<http://www.404manual.com>

<http://www.luxmanual.com>

<http://aubethermostatmanual.com>

Golf course search by state

<http://golfingnear.com>

Email search by domain

<http://emailbydomain.com>

Auto manuals search

<http://auto.somanuals.com>

TV manuals search

<http://tv.somanuals.com>