

USER GUIDE

UGD031/0106

Hopper Temperature Controller

Process Air Heater, 30 to 270 kW.

For use with Conair Carousel Plus Series W Dryers and HADs.

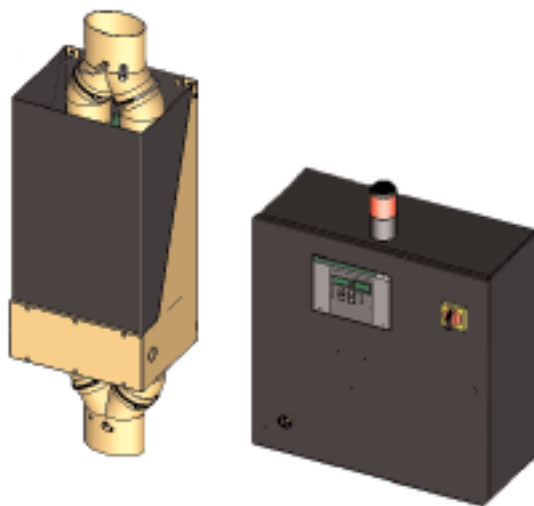

INTRODUCTION • Purpose of the User Guide • How the guide is organized • Your responsibilities as a user • **ATTENTION:** Read this so no one gets hurt • How to use the lockout device • **DESCRIPTION** • What is the HTC process air heater? • Typical applications • How it works • Specifications: HTC Carousel Plus process air dryer • Specifications: HTC models 600 - 5000 • Specifications: HTC for HAD • **INSTALLATION** • Unpacking the boxes • Preparing for installation • Installation of the HTC control models 30, 60, and 90 • Installation of the HTC control model 120 • Installation of the HTC control models 180 and 270 • Location and mounting of the HTC heater assembly models 30, 60, and 90 • Location and mounting of the HTC heater assembly model 120 • Location and mounting of the HTC heater assembly models 180 and 270 • Connecting the HTC heater assembly to the dryer or blower and hopper • Installing the isolation valves • Connecting the power on models HTC 180 and 270 • Connecting the control wiring on models 180 and 270 •

Please record your equipment's model and serial number(s) and the date you received it in the spaces provided.

It's a good idea to record the model and serial number(s) of your equipment and the date you received it in the User Guide. Our service department uses this information, along with the manual number, to provide help for the specific equipment you installed.

Please keep this User Guide and all manuals, engineering prints and parts lists together for documentation of your equipment.

Date:

Manual Number: UGD031/0106

Serial Number(s):

Model Number(s):

DISCLAIMER: The Conair Group, Inc., shall not be liable for errors contained in this User Guide or for incidental, consequential damages in connection with the furnishing, performance or use of this information. Conair makes no warranty of any kind with regard to this information, including, but not limited to the implied warranties of merchantability and fitness for a particular purpose.

Table of Contents

1-1 Introduction

Purpose of the user guide	1-2
How the guide is organized	1-2
Your responsibilities as a user	1-3
ATTENTION: Read this so no one gets hurt	1-4
How to use the lockout device	1-5

2-1 Description

What is the HTC process air heater?	2-2
Typical applications	2-3
How it works	2-4
Specifications: HTC Models 600 - 5000	2-6
Specifications: HTC for Hot Air Dryers (HAD)	2-7

3-1 Installation

Unpacking the boxes	3-2
Preparing for installation	3-3
Installation of the HTC control models HTC 30, 60, and 90	3-3
Installation of the HTC control model HTC 120	3-4
Installation of the HTC control models HTC 180 and 270.	3-4
Location and mounting of the HTC heater assembly models 30, 60, and 90	3-5
Location and Mounting of the HTC heater assembly model HTC 120	3-5

Location and mounting of the HTC heater assembly	
models 180 and 270	3-5
Connecting the HTC heater assembly to the dryer or blower	
and hopper	3-6
Installing the isolation valves	3-7
Connecting the power on models HTC 180 and 270	3-8
Connecting the control wires on models HTC 180 and 270	3-10
Connecting the RTD sensors	3-11
Testing the installation	3-15

4-1 Operation

The HTC process air heater: control panel DC	4-2
HTC DC control functions	4-3
Control function flow charts	4-3
Control function descriptions	4-6
HTC DC control alarms	4-19
Initial operation (for HAD only)	4-20
Initial operation (for Carousel Plus dryer HTC)	4-21
Autotuning	4-22
Normal operation to start heating	4-24
Normal operation to stop heating	4-25

5-1 Maintenance

Preventative maintenance schedule	5-2
---	-----

6-1 Troubleshooting

Before beginning	6-2
A few words of caution	6-3

DIAGNOSTICS

How to identify the cause of a problem	6-4
Shut down alarms	6-5
Passive alarms	6-8

REPAIR

Replacing fuses.	6-9
Checking heater solid state relays.	6-10
Checking or replacing temperature sensors	6-11
Replacing the heating elements	6-12
Replacing the air flow differential pressure switch	6-14

A Appendix

We're here to help	A-1
How to contact customer service	A-1
Before you call...	A-1
Equipment guarantee	A-2
Performance warranty	A-2
Warranty limitations	A-2

AD Addendum

Blower installation and maintenance	AD-1
---	------



Note: This addendum applies only if you have purchased a Conair Hot Air Dryer (HAD).

Introduction

Purpose of the user guide.	1-2
How the guide is organized.	1-2
Your responsibilities as a user.	1-3
ATTENTION:	
Read this so no one gets hurt	1-4
How to use the lockout device.	1-5

Purpose of the User Guide

This User Guide describes the Conair Hopper Temperature Controller (HTC) process air heater and explains step-by-step how to install, operate, maintain and repair this equipment.

Before installing this product, please take a few moments to read the User Guide and review the diagrams and safety information in the instruction packet. You also should review manuals covering associated equipment in your system. This review won't take long, and it could save you valuable installation and operating time later.

How the Guide is Organized

Symbols have been used to help organize the User Guide and call your attention to important information regarding safe installation and operation.



Symbols within triangles warn of conditions that could be hazardous to users or could damage equipment. Read and take precautions before proceeding.



1

Numbers indicate tasks or steps to be performed by the user.



A diamond indicates the equipment's response to an action performed by the user.



An open box marks items in a checklist.



A circle marks items in a list.



Indicates a tip. A tip is used to provide you with a suggestion that will help you with the maintenance and the operation of this equipment.



Indicates a note. A note is used to provide additional information about the steps

Your Responsibility as a User

You must be familiar with all safety procedures concerning installation, operation and maintenance of this equipment. Responsible safety procedures include:

- Thorough review of this User Guide, paying particular attention to hazard warnings, appendices, and related diagrams.
- Thorough review of the equipment itself, with careful attention to voltage sources, intended use, and warning labels.
- Thorough review of instruction manuals for associated equipment.
- Step-by-step adherence to instructions outlined in this User Guide.

ATTENTION:

Read this so no one gets hurt

We design equipment with the user's safety in mind. You can avoid the potential hazards identified on this machine by following the procedures outlined below and elsewhere in the User Guide.



WARNING: Improper installation, operation, or servicing may result in equipment damage or personal injury.

This equipment should be installed, adjusted, and serviced by qualified technical personnel who are familiar with the construction, operation, and potential hazards of this type of machine.

All wiring, disconnects, and fuses should be installed by qualified electrical technicians in accordance with electrical codes in your region. Always maintain a safe ground. Do not operate the equipment at power levels other than what is specified on the machine serial tag and data plate.



WARNING: Voltage hazard

This equipment is powered by three-phase alternating current, as specified on the machine serial tag and data plate.

A properly sized conductive ground wire from the incoming power supply must be connected to the chassis ground terminal inside the electrical enclosure (control center). Improper grounding can result in severe personal injury and erratic machine operation.

Always disconnect and lock out the incoming main power source before opening the control center or performing non-standard operating procedures, such as routine maintenance. Only qualified personnel should perform troubleshooting procedures that require access to the control center while power is on.

How to Use the Lockout Device

 **CAUTION:** Before performing maintenance or repairs on this product, you should disconnect and lockout electrical power sources to prevent injury from unexpected energization or start-up. A lockable device has been provided to isolate this product from potentially hazardous electricity.

Lockout is the preferred method of isolating machines or equipment from energy sources. Your Conair product is equipped with the lockout device pictured below. To use the lockout device:

- 1 Stop or turn off the equipment.**
- 2 Isolate the equipment from the electric power.** Turn the rotary disconnect switch to the OFF, or “O” position.
- 3 Secure the device with an assigned lock or tag.** Insert a lock or tag in the holes to prevent movement.
- 4 The equipment is now locked out.**

 **WARNING:** Before removing lockout devices and returning switches to the ON position, make sure that all personnel are clear of the machine, tools have been removed, and all safety guards reinstalled.

To restore power to the heater, turn the rotary disconnect back to the ON position:

- 1 Remove the lock or tag.**
- 2 Turn the rotary disconnect switch to the ON or “I” position.**

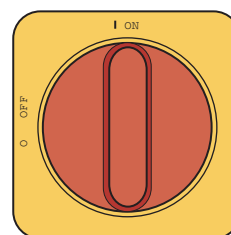
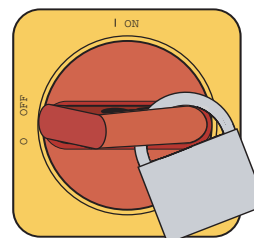
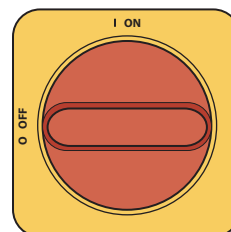

Description

What is the HTC process air heater?	2-2
Typical applications	2-3
How it works	2-4
Specifications: HTC models 600 - 5000	2-6
Specifications: HTC for Hot Air Dryers (HAD) .	2-7

What is the HTC Process Air Heater?

The HTC process air heater is designed to control the temperature of dry air as it enters a material hopper. This process air heater can be set to increase, or “raise”, the temperature of air that was dehumidified at a central dryer or from a blower as part of hot air drying.

The HTC includes a control center, heater box with electric heating elements, an airflow differential pressure switch, and an RTD temperature probe(s).

The differential pressure switch places the HTC in standby mode to save energy and prevent heating element damage when air flow is not present.

Typical Applications

Carousel Plus “W” Dryer

The HTC process air heater is designed for use with a dehumidifying device that supplies dry air, such as a central dehumidifying dryer in which the process heaters (if present) have been disabled, or with a stand alone blower for hot air drying.

The HTC can be used successfully in applications that require:

- Drying temperatures up to 350°F (176.7°C) (250°F [121.1°C] on HAD models).
- The ability to dry multiple materials requiring different drying temperature setpoints in a central drying system. (Requires separate HTCs / hoppers.)
- The ability to easily take a hopper “off-line” for cleaning without shutting down the entire central drying system.

Hot Air Dryer (HAD)

The HTC process air heater, for use with a hot air dryer such as a Conair model HAD, connects plant air motivated by a Conair blower assembly to a material drying hopper.

The HTC for HAD can be used successfully in applications that require:

- Drying temperatures up to 250°F (121.1°C).
- Non-hygroscopic materials that are in pellet or flake form (not powder).
- Open loop drying (not recirculated).

The HTC does not have an integral blower to circulate the hot air, so it can not be used as a stand-alone material preheater. It must be combined with a Conair Carousel Plus Series “W” dryer or HAD.

How it Works

The HTC process air heater works a lot like the thermostat and heater in your house. The RTD probe measures the temperature of the air entering the hopper. If this air is not warm enough to properly dry the material in the hopper, the RTD sends a message to the temperature controller which tells the heater to begin heating. The heating elements inside the heater enclosure heat until the RTD probe senses that the air entering the hopper is at the setpoint entered by the user.

The HTC has a process protection RTD (over-temperature safety). The temperature controller shuts off power to the heating elements if they get too hot and an alarm is generated.

An air flow differential pressure switch detects air flow by sensing the natural drop of pressure due to flow through the heater. This prevents damage to the heater elements or material in the hopper on loss of air flow.

The temperature controller alarms if the heating elements are heating too hot. It also alarms if the heating elements are not heating enough.

How the HTC Works

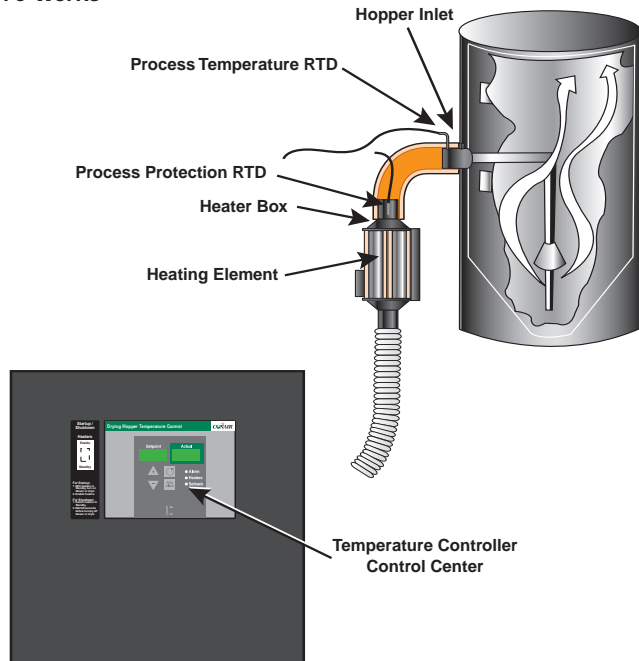

How it Works (continued)

How the HAD Works

- 1 Centrifugal Blower Assembly
- 2 Control Center
- 3 Electric Heater Assembly
- 4 Hose (15 ft)
- 5 Insulated Hose (3 ft)
- 6 RTD Process Temperature
- 7 RTD Process Protection
- 8 Outlet Filter Sock

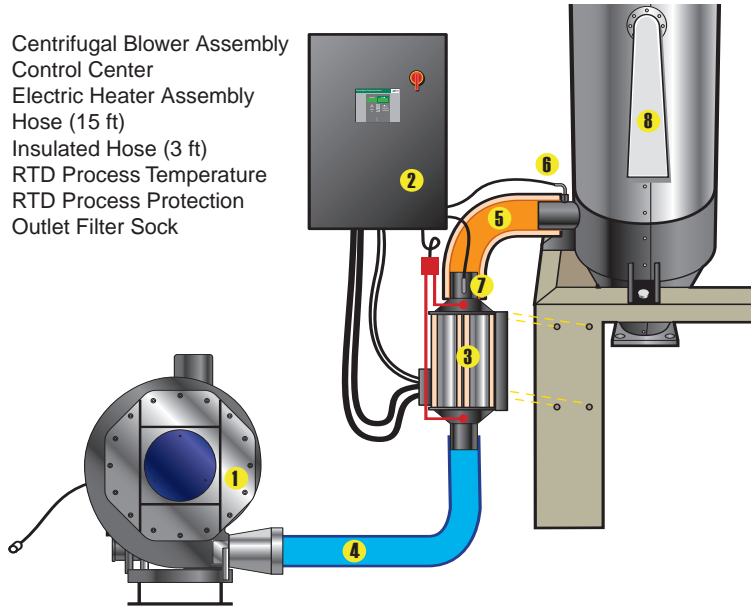

Specifications: HTC MODELS 600 - 5000

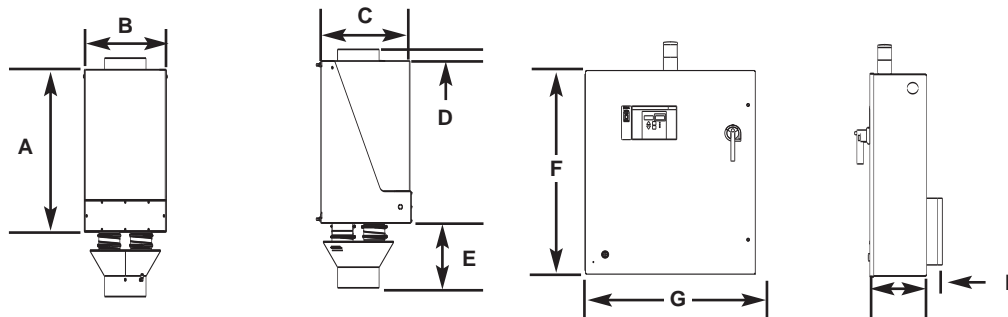

MODEL HTC	HTC-30H*	HTC-60H*	HTC-90H*	HTC-120H*	HTC-180H*	HTC-270H*	
Carousel Plus dryer model	W600	W800	W1000	W1600	W2400	W3200	W5000
Performance characteristics							
Temperature range	150° - 375° F {66° - 191° C}						
Flow rate cfm	300	400	500	800	1200	1600	2500
Pressure drop@flow rate inches WC† {mm} WC†	3.0 {76.2}	1.8 {45.7}	2.3 {58.4}	4.0 {101.6}	3.8 {96.5}	5.9 {149.9}	6.4 {162.6}
Dimensions inches (cm) and weight lb {kg}							
Heater box dimensions							
Inlet size (OD)	8	8	12	12	12	12	
Outlet size selection (OD)	8	8	12	12	12	12	
A - Height	31.4 {79.8}	27.5 {69.9}	27.0 {68.6}	31.0 {78.7}	34.0 {86.4}	36.4 {92.5}	
B - Width	10.1 {25.7}	13.6 {34.5}	16.0 {40.6}	16.0 {40.6}	18.0 {45.7}	24.2 {61.5}	
C - Depth	10.7 {27.2}	10.9 {27.7}	10.9 {27.7}	16.0 {40.6}	17.0 {43.2}	17 {43.2}	
D - Height of discharge nozzle above the heater box	1.75 {4.4}	1.5 {3.8}	2.0 {5.1}	1.0 {2.5}	2.0 {5.1}	1.0 {2.5}	
E - Height of inlet nozzle below the heater box	10.6 {26.9}	7.1 {18.0}	8 {20.3}	10 {25.4}	13 {33.0}	15.4 {39.1}	
Installed weight lb {kg}‡	38 {17}	37 {17}	78 {35}	93 {43}	102 {46}	131 {59}	
Control center dimensions							
Height - F	24.0 {61.0}	24.0 {61.0}	36.0 {91.4}	48.0 {122.0}	60.0 {152.4}	60.0 {152.4}	
Width - G	24.0 {61.0}	24.0 {61.0}	30.0 {76.2}	36.0 {91.4}	42.0 {106.7}	42.0 {106.7}	
Depth - H	10.0 {25.4}	10.0 {25.4}	10.0 {25.4}	10.0 {25.4}	12.0 {30.5}	12.0 {30.5}	
Clearance for heat sink - I	3.0 {7.6}	3.0 {7.6}	3.0 {7.6}	3.0 {7.6}	3.0 {7.6}	3.0 {7.6}	
Installed weight lb {kg}	150.0 {68.0}	150.0 {68.0}	180.0 {81.6}	250.0 {113.0}	consult Conair	consult Conair	
Voltage Full Load Amps							
400 V/3 phase/50-60 Hz	43.3	86.6	129.9	173.2	259.8	389.7	
480 V/3 phase/50-60 Hz	37.7	75.4	113.1	150.8	226.2	339.3	
575 V/3 phase/50-60 Hz	30.1	60.2	90.3	120.4	180.6	270.0	

TPDS022-0106

SPECIFICATION NOTES:
* The HTC model number reflects the kilowatts of each unit. For example, HTC-60 has a 60 kilowatt heater.
† The unit of measure WC is water column.
‡ Weights are approximate.
Specifications may change without notice. Consult a Conair representative for the most current information.

Specifications: HTC for Hot Air Dryers (HAD)

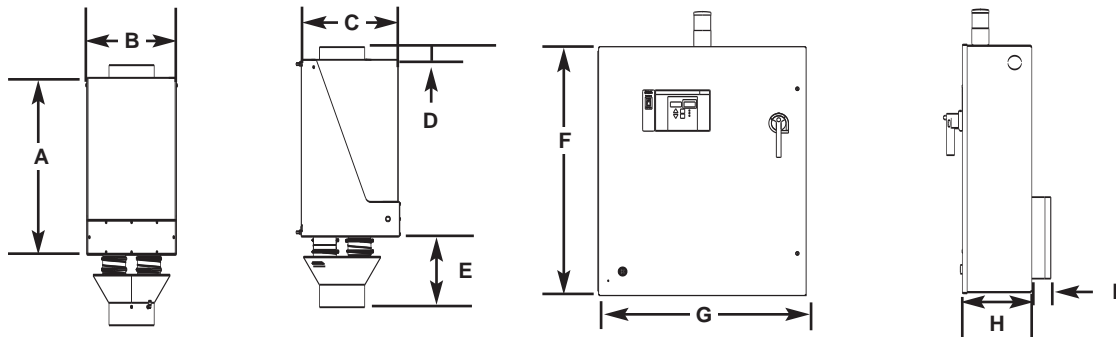

MODEL HTC	HTC-30B*		HTC-30A*	HTC-60A*	HTC-90A*	HTC-120A*	HTC-180A*
Hot air dryer model	600	800	1000	1600	2400	3200	5000
Performance characteristics							
Temperature range	120° - 250° F {49° - 121° C}						
Flow rate cfm	300	400	500	800	1200	1600	2500
Pressure drop@flow rate inches WC†	3.0	5.0	3.2	5.4	6.1	6.4	8.0
{mm} WC†	{76.2}	{127}	{81.2}	{137.2}	{155.0}	{163.0}	{203.2}
Dimensions inches {cm} and weight lb {kg}							
Heater box dimensions							
Inlet size (OD)	5	5	8	8	8	8	12
Outlet size selection (OD)	5	5	8	8	8	8	12
A - Height	31.4 {79.8}	27.5 {69.9}	27.5 {69.9}	32.0 {81.3}	31.0 {79.0}	34.0 {86.3}	34.0 {86.3}
B - Width	10.1 {25.7}	13.6 {34.5}	13.6 {34.5}	15.9 {40.4}	16.0 {40.6}	18.0 {45.7}	18.0 {45.7}
C - Depth	10.7 {27.2}	10.7 {27.2}	10.9 {28.0}	16.0 {40.6}	17.0 {43.2}	20.0 {50.8}	20.0 {50.8}
D - Height of discharge nozzle above heater box	0 {0}	5.9 {15.0}	2.0 {5.1}	1.0 {2.5}	2.0 {5.1}	1.0 {2.5}	1.0 {2.5}
E - Height of inlet nozzle below the heater box	8.0 {20.3}	11.4 {30.0}	8.0 {20.3}	11.0 {27.9}	13.0 {33.0}	13.0 {33.0}	13.0 {33.0}
Installed weight lb {kg}	37 {17}	58 {26}	78 {35}	93 {42}	102 {46}	131 {59}	131 {59}
Control center dimensions							
F - Height	24.0 {61.0}	24.0 {61.0}	24.0 {61.0}	36.0 {91.4}	48.0 {122.0}	60.0 {152.4}	60.0 {152.4}
G - Width	24.0 {61.0}	24.0 {61.0}	24.0 {61.0}	30.0 {76.2}	36.0 {91.4}	42.0 {106.7}	42.0 {106.7}
H - Depth	10.0 {25.4}	10.0 {25.4}	10.0 {25.4}	10.0 {25.4}	10.0 {25.4}	12.0 {30.5}	12.0 {30.5}
I - Clearance for heat sink	3.0 {7.6}	3.0 {7.6}	3.0 {7.6}	3.0 {7.6}	3.0 {7.6}	3.0 {7.6}	3.0 {7.6}
Installed weight lb {kg}	150.0 {68.0}	150.0 {68.0}	150.0 {68.0}	180.0 {81.6}	250.0 {113.0}	consult Conair	consult Conair
Voltage Current Amps							
400V/3 phase/50-60 Hz	43.3	43.3	86.6	129.9	173.2	259.8	259.8
460 V/3 phase/50-60 Hz	37.7	37.7	75.4	113.1	150.8	226.2	226.2
575 V/3 phase/50-60 Hz	30.1	30.1	60.2	90.3	120.4	180.6	180.6

SPECIFICATION NOTES:

* The HTC model number reflects the kilowatts of each unit. For example, HTC-60 has a 60 kilowatt heater.

† The unit of measure WC is water column.

Specifications may change without notice. Consult a Conair representative for the most current information.

TPDS024-0106

Installation

Unpacking the boxes	3-2
Preparing for installation	3-3
Installation of the HTC control models	
HTC 30, 60 and 90	3-3
Installation of the HTC control model	
HTC 120	3-4
Installation of the HTC control models	
HTC 180 and 270	3-4
Location and mounting of the HTC heater	
assembly models 30, 60, and 90	3-5
Location and mounting of the HTC heater	
assembly model HTC 120	3-5
Location and mounting of the HTC heater	
assembly models 180 and 270	3-5
Connecting the HTC heater assembly	
to the dryer or blower and hopper	3-6
Installing the isolation valves	3-7
Connecting the power on models	
HTC 180 and 270	3-8
Connecting the control wires on	
models HTC 180 and 270	3-10
Connecting the RTD sensors	3-11
Testing the installation	3-15

Unpacking the Boxes

The HTC process air heater comes in two boxes. Depending on the model and options ordered, the boxes could include:

Standard Equipment

- Heater assembly;
- Control center;
- 1 insulated hose;
- 1 non-insulated hose;
- 4 hose clamps;
- 2 RTD probes (1 process and 1 process protection);
- Blower (HAD models only).

Optional Equipment

- 1 RTD probe (1 setback).

- 1 Carefully remove all components** from their shipping containers.
- 2 Remove all packing material**, protective paper, tape, and plastic.
- 3 Carefully inspect all components** to make sure no damage occurred during shipping, and that you have all the necessary hardware.
- 4 Take a moment to record serial numbers** and electrical power specifications in the blanks provided on the back of the the User Guide's title page. The information will be helpful if you ever need service or parts.
- 5 You are now ready to begin installation.** Follow the preparation steps on the next page.

Preparing for Installation

The HTC process air heater is easy to install, if you prepare the mounting area properly.

1 Make sure the mounting area provides:

- ❑ **A grounded power source supplying the correct current for your HTC model.** All models require three-phase power. Check the HTC's serial tag for the correct amps, voltage, and cycles. Field wiring should be completed by qualified personnel to the planned location for the HTC. All electrical wiring should comply with your region's electrical codes.
- ❑ **Minimum clearance for safe operation and maintenance.** The HTC control center should be mounted so that its display panel can be seen and touched easily by an operator.
- ❑ **Process air lines installed from the dryer to the HTC location.** For easy maintenance, we recommend using flexible hose to make the final connection between the process outlet of the dryer or blower and the HTC.

Installation of the HTC Control Models HTC 30, 60, and 90

 **CAUTION:** You are responsible for the structural integrity of this installation.

 **NOTE:** The HTC control is shipped mounted on the left side of the floor stand on models 30, 60, and 90 (see figure to the right).

 **NOTE:** If, by using your own provisions, you change the mounting arrangement of the control center to a wall mount unit, it must be mounted 6 inches off of the wall to provide clearance for the heat sink.

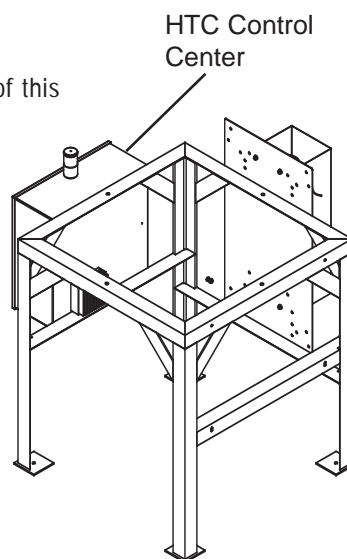

Installation of the HTC Control Model HTC 120

HTC Control Center

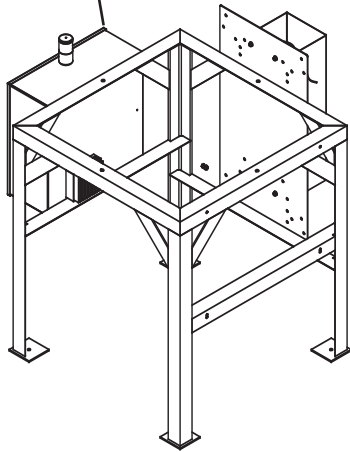

CAUTION: You are responsible for the structural integrity of this installation.

1 Securely bolt the HTC control to the left side of the floor stand. Use the supplied locking fasteners to securely mount the HTC control center to the floor stand to prevent vibration-induced loosening.



NOTE: If, by using your own provisions, you change the mounting arrangement of the control center to a wall mount unit, it must be mounted 6 inches off of the wall to provide clearance for the heat sink.

Installation of the HTC Control Models HTC 180 and 270



CAUTION: You are responsible for the structural integrity of this installation.

1 Move the control center into its final location for operation (see figure to the right). The control center must be positioned close enough to the hopper to allow connection of the RTD temperature probe.

The control center can be mounted to a wall, the hopper frame, or a floor stand with customer provided provisions.

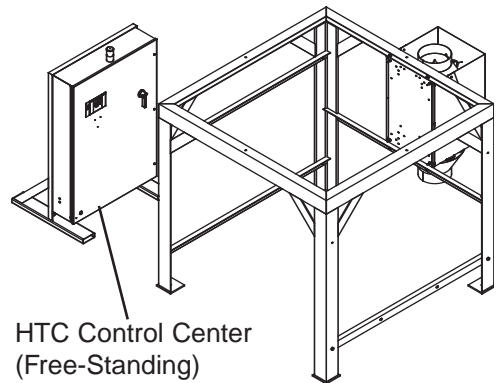

Note: If the length of the process and process protection RTD is too short for your installation, contact Conair Parts Department (800.458.1960) to purchase an extension cable. From outside the United States, call 814.437.6861.



NOTE: If, by using your own provisions, you change the mounting arrangement of the control center to a wall mount unit, it must be mounted 6 inches off of the wall to provide clearance for the heat sink.

Location and Mounting of the HTC Heater Assembly Models HTC 30, 60 and 90



CAUTION: You are responsible for the structural integrity of this installation.



Note: The HTC heater assembly is shipped mounted to the back of the floor stand on Models 30, 60 and 90 (see Figure to the right).

The heater is prewired to the control box on HTC Models 30, 60, and 90.

Location and Mounting of the HTC Heater Assembly Model HTC 120



CAUTION: You are responsible for the structural integrity of this installation.

- 1 Securely bolt the HTC heater assembly to the back of the floor stand (see figure to the right). Use the locking fasteners provided to securely mount the heater assembly to the floor stand to prevent vibration induced loosening.

The heater is prewired to the control box on HTC Model 120.

Location and Mounting of the HTC Heater Assembly Models HTC 180 and 270



CAUTION: You are responsible for the structural integrity of this installation.

- 1 Securely bolt the HTC heater assembly to the back of the floor stand (see figure to the right). Use the locking fasteners provided to securely mount the heater assembly to the floor stand to prevent vibration induced loosening.
- 2 Refer to the wiring diagram to make the wiring connections for the heater and control box. Also, see page 3-8, "Connecting the Power." Only a qualified electrician should make the wiring connections between the control and the heater. The customer must supply the appropriately sized wire and conduit to make connections.

IMPORTANT: Always refer to the wiring diagrams that came with your heater before making electrical connections.

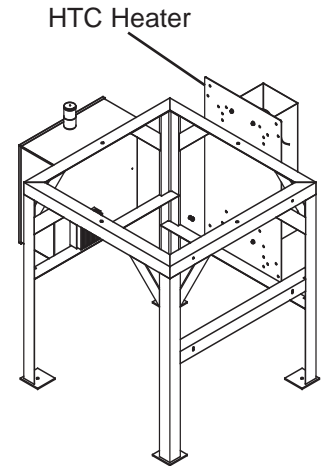

CAUTION: Always disconnect and lock out the main power sources before making electrical connections. Electrical connections should be made only by qualified personnel.



CAUTION: Check the disconnect with a volt meter to insure that the power is off.

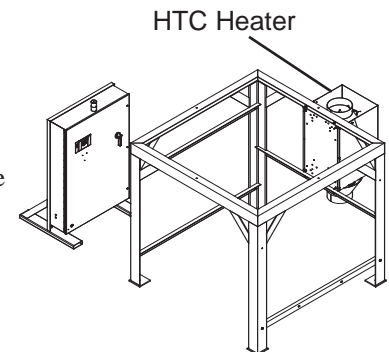

Connecting the HTC Heater Assembly to the Dryer or Blower and Hopper

The inlet of the HTC heater assembly should be plumbed to the air source (usually a blower or central dehumidification dryer). This inlet hose should be at least the size of the heater inlet (lower) connection size (hoses provided). Also, the hose should be as short and straight as possible to prevent unnecessary frictional losses. This hose is the un-insulated and will normally be at ambient temperature plus 50 to 90°F. This hose should be properly supported so no weight will be on the heater inlet connection.



The connection between the heater assembly outlet and the hopper should be made with the supplied insulated hose. The insulation is important from an energy standpoint and for personnel protection. Be careful not to block off any heater sensor mounting locations.

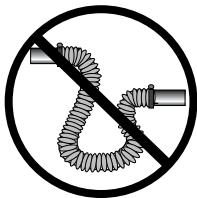

NOTE: Do not allow the flexible hoses to kink or crimp.

Make sure all hoses are securely clamped to prevent wasteful leaking. The hoses should be routed neatly and supported where possible to prevent undue stress on the heater and hopper assemblies. Also, the bends should be made with gradual radiuses. Sharp turns will cause undue pressure drop.

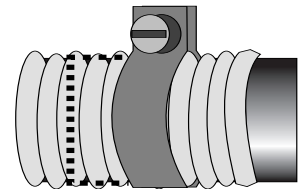

TIP: Units with elliptical or oval shaped inlets or outlets require forming the hose to fit this shape. When tightening the hose clamp, position the screw head on the long radius portion of the duct.

Connect the filter sock or optional dust collector or cyclone to the hopper discharge. Verify the connections are secure and do not leak.

Installing the Isolation Valves

 **NOTE:** Isolation valves should be installed when multiple hoppers are connected to a single dryer or blower.

- 1 Turn the disconnect dial on the control center door to the Off or “O” position.** Lock out the main power (see Page 1-5 for complete lock out information).
- 2 Install one isolation valve in the return air line.** Secure the hoses on the valve with hose clamps.
- 3 Install the other isolation valve in the delivery air line.** Secure the hoses on the valve with hose clamps.

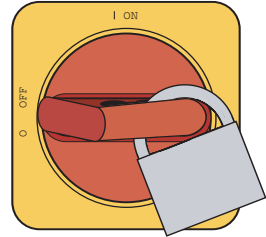

Connecting the Power on models HTC 180 and 270



IMPORTANT: Always refer to the wiring diagrams that came with your heater before making electrical connections.

The electrical connection consists of bringing power into the control center and wiring the heater power from the control center to the heater assembly. The incoming power should match the rated nameplate power required on the serial tag on the control center. This power should be clean and have a voltage variation of no more than +/- 5% of the nameplate voltage. Unless the actual voltage is equal to the nameplate voltage, the actual kW output of the HTC will vary slightly. The output varies with the square of the voltage difference.



CAUTION: Always disconnect and lock out the main power sources before making electrical connections. Electrical connections should be made only by qualified personnel.



CAUTION: Check the disconnect with a volt meter to insure that the power is off.

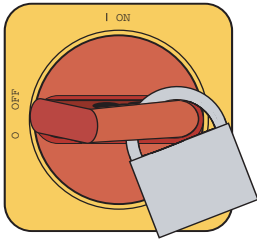

- 1 Disconnect and lock out the main power sources before making electrical connections.** Electrical connections should be made only by qualified personnel.
- 2 Turn the disconnect dial on the control center door to the Off or “O” position.** Turn the captive screw, and swing the control center door open.
- 3 Insert the main power cable** through a knockout in the side of the control center. Secure the power cable with a rubber compression fitting or strain relief or use conduit. Verify that the incoming power is securely attached to the control center and there is no strain on the incoming power.
- 4 Connect the power wires** to the three terminals at the top of the power disconnect holder.
- 5 Connect the ground wire** to the ground lug.



Note: The connection between the heater and control center should be made with properly sized conductors and properly protected with appropriate conduit (customer supplied). The routing should be neat and away from potential mechanical damage. The terminations should be landed on the terminals in the control center and heater junction area. These terminations should be regularly checked to prevent loosening and shorting to ground.

Connecting the Power (continued) on models HTC 180 and 270

- 6 Insert the supplied heater power wire through a knockout in the side or bottom of the control center. Secure the wire with a rubber compression fitting or strain relief if conduit is not used.
- 7 Connect the heater power wires to the control center's terminal block and heater ground wire to the ground lug as shown.

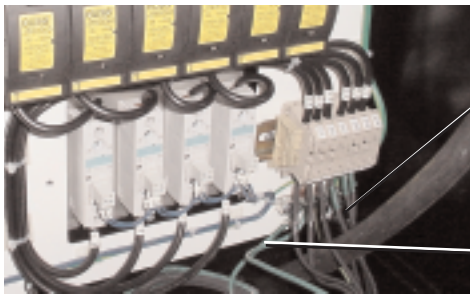

Power Wires
(Gray - Customer
Supplied)

Ground Wires
(Green - Customer
Supplied)

 **IMPORTANT:** Always refer to the wiring diagrams that came with your heater before making electrical connections.

- 8 Insert the other end of heater power wire through the knockout in the side of the heater assembly. Secure the wire with a rubber compression fitting or strain relief if conduit is not used.
- 9 Connect the heater power wires to the top terminals of the heater assembly's terminal block and heater ground wires to the ground lug as shown.

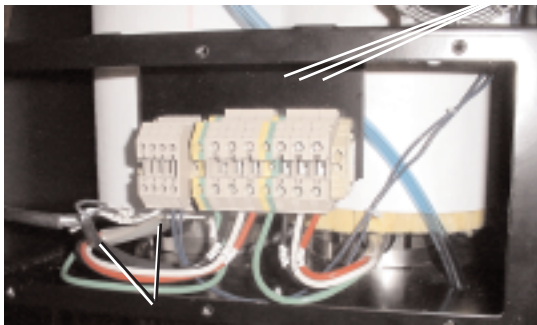

Insert the Power
Wires Here

Ground Wires
(Green/Yellow)

Connecting the Control Wires

Models HTC 180 and 270

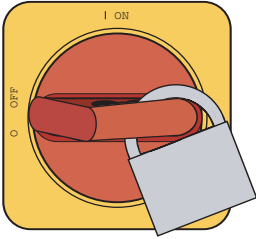

! **IMPORTANT:** Always refer to the proper wiring diagram supplied with your equipment before making electrical connections.

! **CAUTION:** Always disconnect and lock out the main power sources before making electrical connections. Electrical connections should be made only by qualified personnel.

- 1 Refer to the wiring diagram that came with your control.**
- 2 Insert the supplied control wires encased in conduit through a knockout in the side or bottom of the HTC control center.**
- 3 Connect the high temperature and pressure switch wires to the control center's terminal block.**
- 4 Insert the other end of the control wires through the knockout in one side of the HTC heater assembly terminal box.**
- 5 Connect the high temperature and pressure switch wires to the heater assembly terminal block.**

Note: The connection between the heater and control center should be made with properly sized conductors and properly protected with appropriate conduit (customer supplied). The routing should be neat and away from potential mechanical damage. The terminations should be landed on the terminals in the control center and heater junction area. These terminations should be regularly checked to prevent loosening and shorting to ground.

Connecting the RTD Sensors

The lower RTD could be the return air sensor for the setback option if installed or the process protection sensor depending on the configuration of the system. The routing of the sensor cables should be neat and not parallel with the power connections. When a sensor cable must cross over power wiring, the intersection should be made at right angles to reduce the RFI noise transmitted to the sensor cable.



 **IMPORTANT:** Always refer to the wiring diagrams that came with your heater before making electrical connections.

Process Temperature RTD Probe

The RTD sensor connections should be made to the control center via the upper female connections in the side of the control center. The process temperature RTD is to be located in the hopper delivery air inlet. The connection is 1/8 NPT. The sensor should be located $\frac{1}{4}$ to $\frac{3}{4}$ of the way in to the diameter of the inlet to obtain the best temperature reading. The controller uses this RTD to monitor and control the setpoint temperature.



CAUTION: Always disconnect and lock out the main power sources before making electrical connections. Electrical connections should be made only by qualified personnel.

1 Turn the disconnect dial on the control center door to the Off or “O” position. Lock out the main power (see Page 1-5 for complete lock out information).

2 Insert the process RTD probe into the delivery air inlet on the hopper. Center the end of the probe in the inlet so that the tip does not touch the inlet tube walls. Tighten the nuts to lock the RTD probe in place.

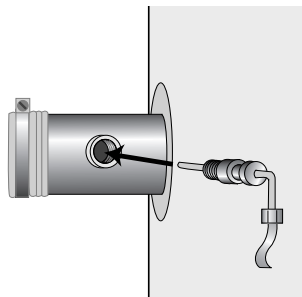

(continued)

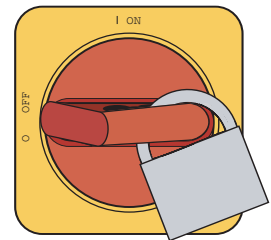



Connecting the RTD Sensors (continued)

- 3 Route the process temperature RTD cable to the control center.** Plug the connector into receptacle in the side of the control center labeled “Process”. Hand tighten the connector. Coil any excess cable and secure it with a wire tie.

Process Protection RTD Probe

The optional process protection RTD probe is a safety sensor that prevents the heater from overheating in case of a process temperature sensor failure or insulated hose failure.

The process protection RTD sensor senses the temperature leaving the heater assembly to prevent damage to the process or the product in the hopper. It generates an alarm (A-49 or A-50) and shuts the heater off if the air temperature exceeds the process protection setpoint. The element for this sensor is to be mounted in the heater assembly outlet nozzle before the insulated hose is connected.



CAUTION: Always disconnect and lock out the main power sources before making electrical connections. Electrical connections should be made only by qualified personnel.

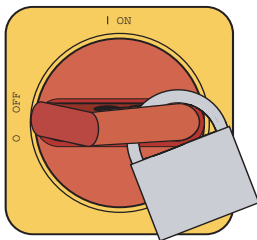

- 1 Turn the disconnect dial on the control center door to the Off or O position.** Lock out the main power (see Page 1-5 for complete lock out information).
- 2 Insert the process protection RTD probe into the heater assembly outlet nozzle.** Center the end of the probe in the outlet so that the tip does not touch the inlet tube walls. Tighten the nuts to lock the RTD probe in place.

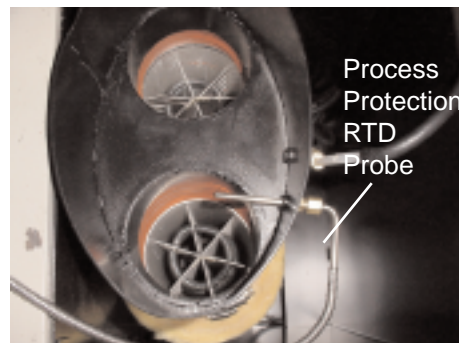

Connecting the RTD Sensors (continued)

- 3 Route the process protection RTD cable to the control center.** Plug the connector into the receptacle in the side of the control center labeled "Protection". Hand tighten the connector. Coil any excess cable and secure it with a wire tie.

Process Setback RTD Probe (Optional)

The optional process setback RTD probe is a sensor in the outlet of the hopper and is normally supplied with a closed loop dehumidifying dryer system. The purpose of the setback option is to reduce the energy consumption and prevent over drying when material stops flowing through the hopper.



CAUTION: Always disconnect and lock out the main power sources before making electrical connections. Electrical connections should be made only by qualified personnel.

- 1 Turn the disconnect dial on the control center door to the Off or O position.** Lock out the main power (see Page 1-5 for complete lock out information).
- 2 Insert the process setback RTD probe into the hopper outlet.** Center the end of the probe in the process air outlet of the hopper so that the tip does not touch the outlet tube walls. Tighten the nuts to lock the RTD probe in place.

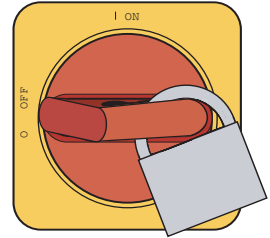

Note: If the length of the setback RTD is too short for your installation, contact Conair Parts Department (800.458.1960) to purchase an extension cable. From outside the United States, call 814.437.6861.

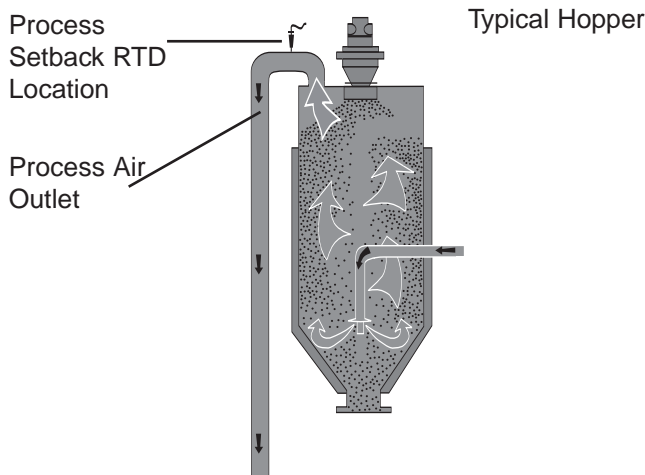

(continued)

Connecting the RTD Sensors (continued)

- 3 Route the process setback RTD cable to the control center.** Plug the connector into the lower receptacle in the side of the control center. Hand tighten the connector. Coil any excess cable and secure it with a wire tie.

Testing the Installation

You have completed the HTC installation. Now it's time to make sure everything works.

- 1 Make sure there is no material in the hopper.** If there is a loader or vacuum receiver mounted on the hopper, disconnect the material inlet hose at the source.
- 2 Perform the following safety checks:**
 - Make sure all components are securely mounted;
 - Make sure all hoses are connected to the proper locations and secured with hose clamps;
 - Make sure all sensors are properly installed and secured;
 - Make sure all wiring is secure and away from potential mechanical damage;
 - Make sure the air filter is clean and has a minimum of 6 in. (15.2 cm) clearance without any flow obstructions; and
 - Make sure the hopper outlet is free from obstructions that would cause back pressure in the drying hopper.
- 3 Perform a resistance test.** Check the resistance leg to leg and leg to ground to make sure that each heater and blower are wired correctly. The three legs should have equal resistance +/- 5%. The resistance to ground should be 20 megohms or higher.
- 4 Turn on the main power to the HTC.** Make sure the disconnect dial is in the ON position. This powers up the control and the display lights will illuminate.

For Hot Air Dryer (HAD) Models Only

- 5 Bump (rapidly start and stop) the blower motor and verify the motor is turning in the correct rotation** according to the labels on the motor. If the rotation is incorrect, shut off and lock out power and switch any two of the three power legs on the line side of the disconnect provided with the blower.
- 6 Check the discharge damper setting.** The handle on the outlet of the blower is connected to the discharge damper. This is required to be set to the proper position to determine the proper airflow for the heater/hopper. Adjust the discharge damper until the blower pressure is 20 to 30 in. W.C.

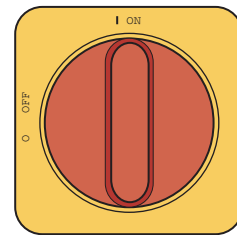

 **NOTE:** See the blower specifications sheet in the appendix for design supply pressure.

(continued)

Installation | 3-15

Testing the Installation (continued)

- 7 **Adjust the setpoint to the desired hopper inlet temperature.** Use the Setpoint Adjust ▲ or ▼ buttons to set the temperature. Move the heater enable switch to the enable position. The temperature should stabilize around the setpoint and not significantly overshoot the set temperature.

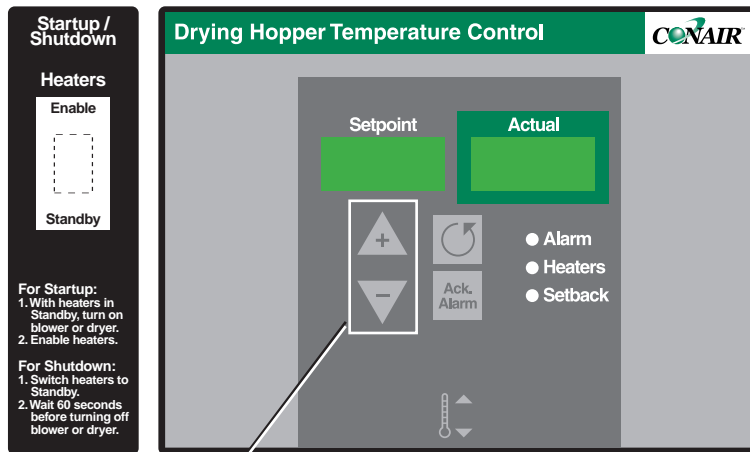

Setpoint Adjust Buttons

- 8 **If everything is working properly, the heater's LED flashes and the temperature climbs towards the setpoint.**

For Carousel Plus Dryers

- 5 Reference the dryer manual and **verify the dryer's blower is running in the correct direction and the dryer is ready for operation.**
- 6 **Start the dryer.**
- 7 **Adjust the setpoint to the desired hopper inlet temperature.** Use the Setpoint Adjust ▲ or ▼ buttons to set the temperature. Move the heater enable switch to the enable position. The temperature should stabilize around the setpoint and not significantly overshoot the set temperature.
- 8 **If everything is working properly, the heater's LED flashes and the temperature climbs towards the setpoint.**

Operation

The HTC process air heater: control	
panel DC	4-2
HTC DC control functions	4-3
Control function flow charts	4-3
Control function descriptions	4-6
HTC DC control alarms	4-19
Initial operation (for HAD only)	4-20
Initial operation (for Carousel Plus	
dryer HTC)	4-21
Autotuning	4-22
Normal operation to start heating	4-24
Normal operation to stop heating	4-25

The HTC Process Air Heater: Control Panel DC

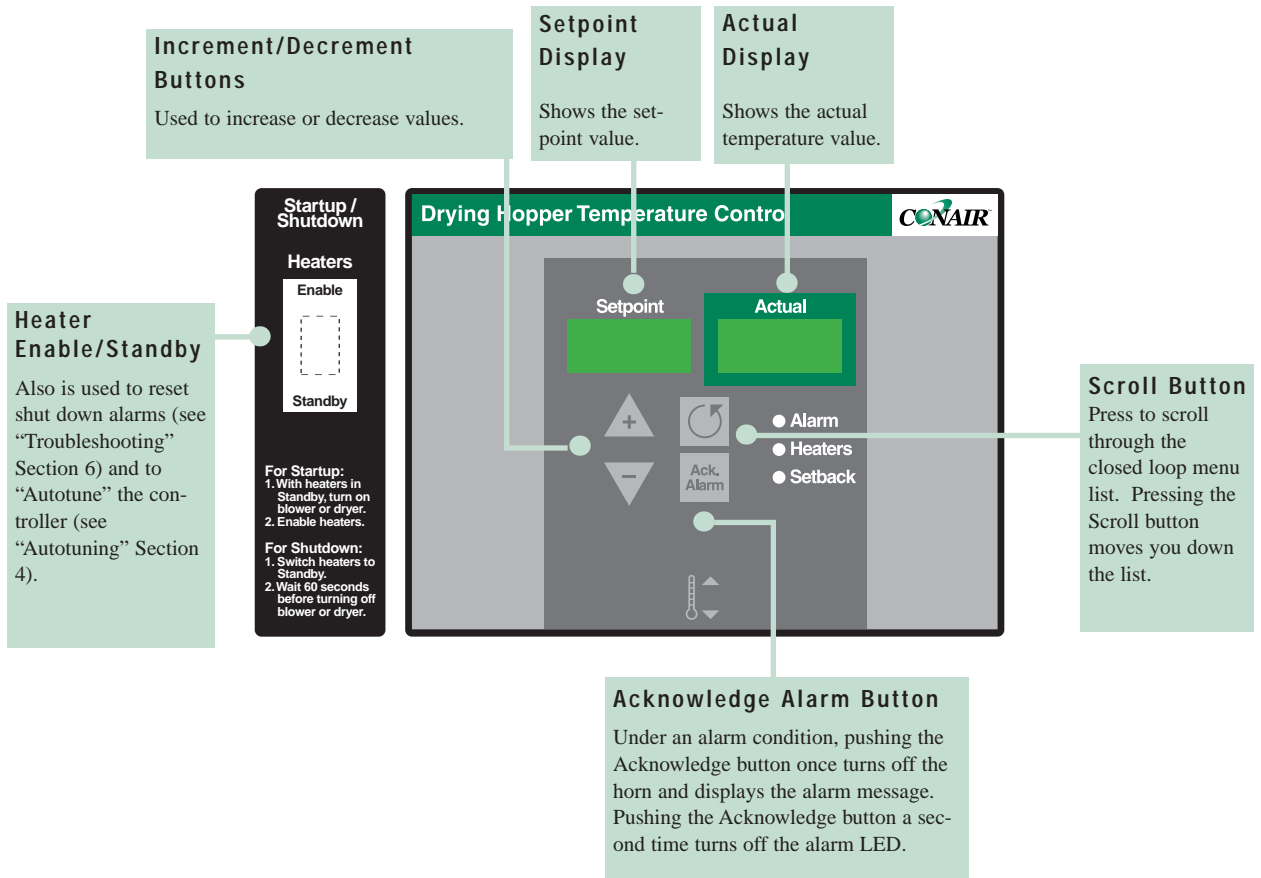

HTC DC Control Functions

HTC functions are values that you can set or monitor. Press the Scroll button until the function you want to set or monitor appears in the LED display.

Control Function Flow Charts

The following flow charts provide a quick summary of the control functions. For an explanation of each control function, see Control Function Descriptions.

POWER ON

1 2 sec All LEDs On

2 2 sec Software Version

3

(Default Screen) 4 Process Setpoint and Actual Temp (Default Screen)

Press + or - to change setpoint.

Press Scroll Button for Process Deviation Alarm Setpoint (Dev)

5 + or - Deviation Band

Press + or - to change setpoint.

Press Scroll to enter the value

Press Scroll Button again for Setback

Return Temperature Setpoint

(Optional)

5A

Press + or - to change setpoint.

Press Scroll to enter the value

Press Scroll Button again for Process

Setback Temperature Setpoint

5B

Press + or - to change setpoint.

Press Scroll to enter the value

Process Screens

Press Scroll Button and + key at the same time for 2 sec to get in.

To get out at any time Press Scroll button and - key at the same time
2 Min timer then return to the default screen

6

Press Scroll again to view next screen

7 Process High Limit

Press Scroll again to view next screen

8 Process Loop Break Band

Press Scroll again to view next screen

9 Process Loop Break Time

Press Scroll again to view next screen

10 Process High Alarm Setpoint

Press Scroll again to view next screen

11 Process Prop

Press Scroll again to view next screen

12 Process Integral

Press Scroll again to view next screen

13 Process Derivative

Press Scroll again to view next screen

14 Process Autotune

Press + Key to Start Autotune

Press Scroll again to view next screen

15 Units degrees F or degrees C

Press + Key to toggle between F and C

Press Scroll again to view the first screen

Process Protection Screens

Press Scroll Button and + key at the same time for 2 sec to get in.

To get out at any time Press Scroll button and - key at the same time

16

Press Scroll again to view next screen

17 Protect Temperature

Press Scroll again to view next screen

18 Protect Hi Alarm SP

Press Scroll again to view next screen

19 Protect Hi Alarm Delay

Press Scroll again to view next screen

20 Differential Alarm SP

Press Scroll again to view next screen

21 Differential Alarm Delay

Press Scroll again to view the first screen

Setback Setup Screens

Press Scroll Button and + key at the same time again for 2 sec to get in.
To get out at any time Press Scroll button and - key at the same time

30 [Set] [bAc]

Press Scroll again to view next screen

31 [ret] [250]

Press Scroll again to view next screen

32 [20] [ban]

Press Scroll again to view next screen

33 [10] [sls]

Press Scroll again to view next screen

34 [Ldr] [0]

Press Scroll again to view next screen

34A [Sbt] [OFF]

Press Scroll again to view next screen

34B [SbL] [OFF]

Press Scroll again to view next screen

35 [2] [P.dL]

Press Scroll again to view next screen

35A [10] [A.dL]

Press Scroll again to view next screen

Setup Screens

Press Scroll Button and + key at the same time for 10 sec to get in.
To get out at any time Press Scroll button and - key at the same time

36 [SEt] [uP]

Press Scroll again to view next screen

37 [tyP] [Res] Controller Type

Press Scroll again to view next screen

38 [Prt] [ON] Process Protection Install

Press Scroll again to view next screen

39 [Stb] [OFF] Setback Install

Press Scroll again to view next screen

40 [Id] [1]

Not applicable to the HTC

Press Scroll again to view next screen

41 [tSt] [OFF] Goto Test Mode

Press Scroll again to view next screen

42 [Ld.d] [OFF] Load Default

Press + Key to Load Default

Press Scroll again to view the first screen

[Add] [res]

[0] [500]

[24] [501]

[2] [502]

[23] [503]

[4] [504]

Test Mode Screens

* The test mode screens become visible if tSt (screen 41) is turned on.

To get out at any time Press Scroll button and - key at the same time

43 [tE] [St]

Press Scroll again to view next screen

44 [in.1] [OFF] Digital Input 1 status

Press Scroll again to view next screen

45 [in.2] [OFF] Digital Input 1 status

Press Scroll again to view next screen

47 [in.4] [ON] Digital Input 4 status

Press Scroll again to view next screen

50 [ou.3] [OFF] Press + key to jog output 3

Press Scroll again to view next screen

52 [ou.5] [OFF] Press + key to jog output 5

Press Scroll again to view next screen

53 [ou.6] [OFF] Press + key to jog output 6

Press Scroll again to view the first screen

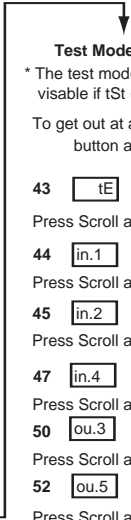

Control Function Descriptions

General Screens

SCREEN 1

888	888
-----	-----

SCREEN 2

dC	004
----	-----

SCREEN 3

res	in
-----	----

SCREEN 4

Setpoint	Actual
250	250

SCREEN 5

20	dEv
----	-----

Function

Once the power is turned on, this screen is displayed for 2 seconds while the control performs its self-checking process. All LEDs are illuminated during this 2-second interval.

After the self-checking process is complete, this screen flashes for 2 seconds and displays the software version.

After the software version is displayed, this screen appears for 2 seconds and identifies that the control is setup for a wheel dryer (2) or HAD.

This is the default screen. It shows the process air temperature setpoint and the actual temperature measured at the inlet to the drying hopper. The “+/-” buttons can be used to change the setpoint. Holding the “+/-” buttons in will cause the number to ramp up or down faster the longer the button is held. The display will return to the default screen from anyplace in the menu structure if nothing is done for 10 minutes.

This is the process deviation temperature alarm setpoint screen. It is used to set the deviation temperature band around the process temperature setpoint. The range is 5 - 20°F (2.8 - 11.1°C). The “+/-” buttons can be used to change the setpoint. If the temperature goes outside the band, the control will display a passive alarm (P1).

Control Function Descriptions (continued)

General Screens

SCREEN 5A

180

Srt

SCREEN 5B

140

PSt

Function

Setback Screen 1 (Setback Setpoint).

When setback is enabled, this is the hopper outlet temperature at which the setback becomes active.

 **NOTE:** Setback is optional.

Setback Screen 2 (Process Setpoint). The process setpoint is the temperature the control tries to maintain when functioning in the setback mode.

Control Function Descriptions (continued)

Process Screens **Function**

To access the process screens, press the “Scroll” and “+” buttons at the same time and hold for two seconds . To get out of the Process screens at any time, press the Scroll and “-” buttons at the same time. After two minutes, you will be returned to the Default screen.

SCREEN 6

Pro **cES**

This is the process header screen. It indicates that all items below it pertain to the process temperature control.

SCREEN 7

250 **Hi.L**

This is the process high limit screen. It is used to set the high limit for the process temperature setpoint. The “+/-” buttons can be used to change this value. If set at 250°F, the operator cannot set the process setpoint above 250°F.

SCREEN 8

3 **Lbb**

This is the process loop break band screen. It is used to set the temperature band for the loop break alarm. The “+/-” buttons can be used to change the setpoint. If outside the deviation band, if the actual temperature does not move toward the setpoint by this value in the time value in screen 9, a loop break alarm will occur.

Control Function Descriptions (continued)

Process Screens Function

SCREEN 9

10

Lbt

This is the process loop break time screen. It is used to set the temperature band time for the loop break alarm. The “+/-” buttons can be used to change the temperature band time. When the actual temperature is outside the deviation band, if the temperature is not moving toward the setpoint at a rate greater than or equal to the value in screen 8, page 4-8, for the time value in this screen (sec.), then the heater will alarm on loop break. Once the actual temperature is within the deviation band, the loop break is ignored.

SCREEN 10

250

H.AL

This is the process alarm high temperature setpoint screen. It is used to set the temperature at which the process high temperature shutdown alarm (A1) will shutdown the heater and display the alarm. The “+/-” buttons can be used to change the setpoint.

SCREEN 11 *

50

Pb

This is the process proportional band screen. It is used to change the proportional band value for the process control loop. The “+/-” buttons can be used to change the proportional band setpoint.

SCREEN 12 *

16

int

This is the process integral screen. It is used to change the integral value for the process control loop. The “+/-” buttons can be used to change the integral value setpoint.

SCREEN 13 *

2

dEr

This is the process derivative screen. It is used change the derivative value for the process control loop. The “+/-” buttons can be used to change the derivative value setpoint.

* These parameters will be automatically adjusted by the autotune procedures. Conair does not recommend they be adjusted individually.

(continued)

Operation | 4-9

Control Function Descriptions (continued)

Process Screens

Function

SCREEN 14



This is the process heater autotune screen. (See page 4-22 for detailed information on the autotune function.) The autotune procedure should be performed when setting up the system the first time or if the control is inconsistent. Autotuning may take a minute or so to complete. When finished, the display will read “don”. The new PID values are automatically saved (to screens 11, 12, and 13).

SCREEN 15



This is the temperature units screen. It is used to change the temperature display from °F to °C or °C to °F.

Control Function Descriptions (continued)

Process Protection Screens *

* Accessed from the Process Screens.

SCREEN 16
Protection

Pro **tEc**

SCREEN 17

Act **250**

SCREEN 18

625 **H.AI**

Function

When at screen 6, page 4-8, (or the process screens), to access the process protection screens, press the “Scroll” and “+” buttons at the same time and hold for two seconds from the Process screens. To get out of the Process protection screens at any time, press the “Scroll” and “-“ buttons at the same time. (Refer to the flow charts on pages 4-4 and 4-5.)

This is the process protection header screen. It indicates that all items below it pertain to the process protection actual temperature and alarms.

This screen shows the actual temperature measured at the process protection RTD.

This is the process protection high temperature alarm setpoint screen. If the actual process protection temperature exceeds this setpoint for the length of the process protection high alarm delay (screen 19, page 4-12), the process protection alarm (A49) will trigger and the heater will shut-down. For example if the actual process protection temperature exceeds 625°F (330°C) for 10 seconds, the heater will execute a shutdown alarm. The +/- buttons can be used to change the setpoint.

(continued)

Control Function Descriptions (continued)

Process Protection Screens

* Accessed from the Process Screens.

SCREEN 19

10

H.dL

Function

This is the process protection high alarm delay screen. It is used to set the delay time for the process protection high temperature alarm. If this time delay is exceeded, the heater will execute a shutdown alarm (A49). The “+/-” buttons can be used to change the setpoint.

SCREEN 20

325

d.AL

This is the process differential alarm setpoint screen. If the actual process protection temperature (screen 17, page 4-11) minus the actual process temperature (screen 4, page 4-6) exceeds this setpoint for the length of the process differential alarm delay (screen 21), this alarm (A50) will trigger and the heater will shutdown. For example if the actual process protection temperature is 450°F (232.2°C) and the actual process temperature is 124°F (51.1°C) for 180 seconds (default) or the time set on Screen 21, the heater will execute a shutdown alarm (A50). The “+/-” buttons can be used to change the setpoint.

SCREEN 21

180

d.dL

This is the process differential alarm delay screen. This screen is used to change the process differential alarm delay time. The “+/-” buttons can be used to change the setpoint.

Control Function Descriptions (continued)

DC Resin Setup Screen

Function

To access the DC resin setup screens, press the Scroll and “+” buttons at the same time and hold for two seconds from the Process Protection screens (screen 16). To get out of the DC resin setup screens at any time, press the Scroll and “-“ buttons at the same time.

SCREEN 30

Set	bAc
------------	------------

This is the setback option setup screen. It indicates that all items below it pertain to the setback option.

SCREEN 31

ret	250
------------	------------

This shows the actual return air temperature measured at the hopper outlet.

SCREEN 32

20	ban
-----------	------------

This shows the setback return band setting. The value is used to determine when the setback mode is disabled, once the dryer has gone into the setback mode. This example indicates a 20° band width, which means when your hopper outlet temperature is 20° below your setpoint, the dryer will come out of setback mode.

Control Function Descriptions (continued)

DC Resin Setup Screen **Function**

SCREEN 33

10 **sls**

This is the setback load rate setpoint. (Not available at this time.)

SCREEN 34

Ldr **0**

This is the load rate reading. (Not available at this time.)

SCREEN 34A

Sbt **OFF**

This is the setback on temperature. It turns the setback on temperature option on or off.

SCREEN 34B

SbL **OFF**

This controls the setback on load rate function. It turns the setback on load rate option on or off. (Not available at this time.)

Control Function Descriptions (continued)

DC Resin Setup Screen

SCREEN 35

2

P.dL

This is the process heater alarm delay. It is used to delay the process heater alarm. This number is the delay time in seconds that an alarm will occur on loss of process heat.

SCREEN 35A

10

A.dL

This is the airflow alarm delay. It is used to delay the airflow alarm. This number is the delay time in seconds that an alarm will occur on loss of airflow.

Control Function Descriptions (continued)

Setup Screens

Function

SCREEN 36



To access the setup screens, press the Scroll and "+" buttons at the same time and hold for ten seconds from the Process screens. To get out of the setup screens at any time, press the Scroll and "-" buttons at the same time.

This is the initial setup screen. It indicates that all items below it pertain to the heater setup.

SCREEN 37



This screen indicates the hardware to the controller. It will say "Res".

SCREEN 38



This screen turns the process protection off and on. The HTC is shipped with this function set to "On" unless the HTC is sold with an HAD.

Screen 39



For HAD and "W" dryer models only. This screen turns the setback "On" or "Off". The HTC is shipped with function set to "On" if the setback option is installed.

Screen 41



This screen lets you access the Test Mode. To access the test mode screens, press "+" button when you are in the test screen. To get out of the test mode screens at any time, press the Scroll and "-" buttons at the same time.

Screen 42



This screen returns the control board to the factory default settings (not necessarily for a specific model). Conair does not recommend using this function unless instructed to by a Conair Service Technician.

 The setting on screen 42 should not be changed without the direction of Conair Service Personnel.

Control Function Descriptions (continued)

Test Mode Screens

Function

To access the test mode screens, press "+" button when you are in the test screen (screen 41). To get out of the test mode screens at any time, press the Scroll and "-" buttons at the same time.

SCREEN 43



This is the Test Mode screen. While in the test mode, you can see the status of the inputs and outputs and you can toggle the outputs on or off by pressing the up and down arrow keys on the control.

SCREEN 44 *



* See the supplied electrical drawings to associate instruments to inputs.

This screen shows the state of digital input 1. If the input is open, "OFF" will be displayed. If the input is closed, "ON" will be displayed. Digital input 1 on a heater is the process high temperature switch. This switch is closed during normal operation. It opens when it detects a high temperature inside the process heater tube.

SCREEN 45



This is the heat enable/disable screen. It shows the state of digital input 2. If the input is open, "OFF" will be displayed. If the input is closed, "ON" will be displayed.

SCREEN 47



This is the differential pressure (flow switch) screen. It shows the state of digital input 4. If the input is open, "OFF" will be displayed. If the input is closed, "ON" will be displayed.

(continued)

Control Function Descriptions (continued)

Test Mode Screens *

* Outputs 1, 2, and 4 are not used in the HTC.

SCREEN 50

ou.3 **OFF**

SCREEN 52

ou.5 **OFF**

SCREEN 53

ou.6 **OFF**

Function

This is the output 3 screen. Press the "+" key to jog output 3. Output 3 on a heater is the process heater solid-state relay signal. Pressing the "+" key will cause the process solid-state relays to fire. You can observe the solid-state relay LED to check this output. Since the isolation contactor is open, the heater does not come on because it does not have power.

This is the output 5 screen. Press the "+" key to jog output 5. Output 5 on a heater is the process heater power isolation contactor signal. Pressing the "+" key will cause the isolation contactor to close. Watch the isolation contactor pull in to check this output. Since the solid-state relays are not on, the heaters does not come on because they do not have power.

This is the output 6 screen. Press the "+" key to jog output 6. Output 6 on a heater is the alarm horn. Pressing the "+" key will cause the alarm horn to sound.

HTC DC Control Alarms

PASSIVE ALARMS

Passive alarms flash the alarm code and display process temperature until the alarm condition goes away, or it becomes a shutdown alarm.

Code	Description	Alarm LED
P1	Process Temperature Deviation	Blinking Red

SHUTDOWN ALARMS

Shutdown alarms flash the alarm code and display process temperature. The HTC process air heater should stop when the process temperature is below 150°F (65.6°C) but should still flash the alarm code until the Acknowledge Alarm button is pressed. If the alarm condition is still active, the HTC cannot start, it will flash the alarm code again. If the alarm condition is not active, the display should return to the normal default screen display and the HTC is ready to run.

Alarms place the control in “standby” mode. After the alarm is corrected and acknowledged, cycle the heater Standby/Enable switch to “Standby” then back to “Enable” to restart the process control.

Code	Description	Alarm LED
A1	Process High Temperature	Solid Red
A2	Process Temperature Loop Break	Solid Red
A3	Process Heater Box High Temperature	Solid Red
A10	RTD Integrity	Solid Red
A39	EEProm Write Error-Internal Control Board Problem	Solid Red
A49	Process Protection High Alarm	Solid Red
A50	Process Differential Alarm	Solid Red

Initial Operation (For HAD Only)

- 1 Hopper material:** Fill the hopper with the material to be heated.
- 2 Blower inlet filter:** Verify that the area around the inlet filter is clean and free of debris. This will extend the time between service of this filter.
- 3 Air discharge from the hopper:** Verify that the sock filter hose connection to the dust collector connections are secure and do not leak.
- 4 Setting of damper after material:** The damper valve will need to be opened to adjust the flow back down to 20 in. W.C. on the pressure gauge. This setting is a suggested setting. If the airflow in the hopper is carrying over material out of the hopper, then the flow rate may be adjusted downward by closing the damper. If the airflow is too low then the heater will go into stand by. If the airflow is too high, the setpoint might not be achievable.



WARNING: Fire potential - The electric heating elements are exposed to the air going into the hopper. It is important that there is no debris in this air stream. Under no circumstances should the HTC be run in a dirty air stream as material passing through the heater could ignite embers and shoot sparks into the hopper, which could catch fire.

- 5 Auto tuning:** When the unit is fully assembled and ready for operation, it should be tuned to the actual system that it is connected to with material in the hopper. Follow the auto tuning procedure detailed on page 4-22 of this manual.
- 6 Hopper residence time:** The material throughput rate must be determined by the size of the hopper, the drying time required, and the extent of drying desired for the product.

Initial Operation (For Carousel Plus Dryer HTC)

1 Hopper material: Fill the hopper with the material to be heated.



WARNING: Fire potential - The electric heating elements are exposed to the air going into the hopper. It is important that there is no debris in this air stream. Under no circumstances should the HTC be run in a dirty air stream as material passing through the heater could ignite embers and shoot sparks into the hopper, which could catch fire.

2 Auto tuning: When the unit is fully assembled and ready for operation, it should be tuned to the actual system that it is connected to with material in the hopper. Follow the auto tuning procedure detailed on page 4-22 of this manual.

3 Hopper residence time: The material throughput rate must be determined by the size of the hopper, the drying time required, and the extent of drying desired for the product (see page 4-20).

Autotuning

 **Tip:** Conair recommends that the autotune should be run from a cold start. The minimum temperature difference between the start temperature and the autotune and setpoint temperature you will be running should be 50°C (122°F).

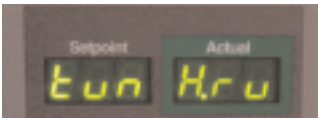

Follow the procedure below to “Autotune” the HTC.

- 1 Use the selector switch and put the HTC control into “Standby”.
- 2 Adjust the setpoint to a “Normal” setting.
- 3 Establish the normal operating air flow.
- 4 Access the Process menu by pressing and holding the Scroll and Plus keys for 2 seconds until “Process” is displayed.

Pro cES

- 5 Press the Scroll key until “Tune Off” is displayed.

tun OFF

- 6 Press the Plus key and “Tune Set” is displayed. If the control remains on screen 6, the difference between the setpoint and the actual temperature is not at least the required minimum.

tun SEt

- 7 Enable the heater after the system stabilizes. The following will display when autotuning starts.

tun Hr.u

- 8 When autotune is complete, “Tune Done” is displayed and the heater is placed in the Standby mode.

tun don

- 9 Note the “Pb”, “int”, and “dEr” values (screens 11, 12, and 13).

Autotuning (continued)

- 10** To return to the normal control, cycle the heater to Standby and then back to Enable.
- 11** If “Tune Error 1” is displayed, the autotune was not successful and the process must be repeated. The most likely reason for this error is that the difference between the starting temperature and the autotune temperature was not at least 50°C (122°F).



tun Er.1

Normal Operation To Start Heating

- 1 Determine what the HTC's setpoint must be for your process and material.
- 2 Make sure there is material in the hopper.
- 3 Start the dryer or process blower to begin air flow. Set the proper flow on the blower if equipped.
- 4 Turn on the main power to the HTC. Make sure the HTC's disconnect dial is in the ON position. This powers up the control and the display lights will illuminate.
- 5 Set the drying temperature. Press the Adjust Setpoint ▲ or ▼ buttons to select the temperature.

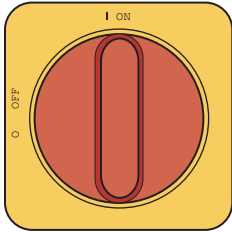

Setpoint Adjust Buttons

Startup / Shutdown

Heaters

Enable

Standby

For Startup:
1. With heaters in Standby, turn on blower or dryer.
2. Enable heaters.

For Shutdown:
1. Switch heaters to Standby.
2. Wait 60 seconds before turning off blower or dryer.

Drying Hopper Temperature Control CONAIR

Setpoint

Actual

+

-

Ack. Alarm

Alarm

Heaters

Setback

- 7 Turn the heater switch to “Enable” to start heating.

Normal Operation To Stop Heating

1 Turn the heater to “Standby”.

 **IMPORTANT:** Always turn off the HTC **BEFORE** the dryer or process blower.

2 Allow the HTC to cool to below 100°F (37.8°C).

3 Turn off the blower or dryer.

4 Be sure to disconnect and lockout the main power if you have stopped the HTC to perform maintenance or repair.

 **CAUTION:** Improper shut down can cause damage to your heater.

Startup / Shutdown

Heaters

Enable



Standby

For Startup:
1. With heaters in Standby, turn on blower or dryer.
2. Enable heaters.

For Shutdown:
1. Switch heaters to Standby.
2. Wait 60 seconds before turning off blower or dryer.



Maintenance

Preventative maintenance checklist 5-2

Preventative Maintenance Checklist

The HTC process air heater requires little maintenance. We recommend the following maintenance schedule and tasks.

- **Whenever you change material or process**
 - Change the HTC setpoint if it must be changed.**

- **Daily or weekly as needed**
 - Inspect the inlet and outlet hoses.**
Tighten the hose clamps if loose. Replace the hose if worn or damaged.

 - Inspect the filter (if equipped).**
Clean or replace the filter as necessary.

- **Monthly or as often as needed**
 - Inspect the main power wires, heater wires and conduit, and RTD probe wires for damage and wear.**
Replace any damaged or worn wire or conduit.

 - Check for any damage to the control panel.**
Replace if damaged.

 - Check for damage to the heater box.**
Replace if damaged.

 - Clean dirt from exterior surfaces with a cloth dampened with water.**

Troubleshooting

Before beginning 6-2

A few words of caution 6-3

DIAGNOSTICS

How to identify the cause of a problem 6-4

Shut down alarms 6-5

Passive alarms 6-8

REPAIR

Replacing fuses 6-9

Checking heater solid state relays 6-10

Checking or replacing temperature

 sensors 6-11

Replacing the heating elements 6-12

Replacing the air flow differential

 pressure switch 6-14

Before Beginning

You can avoid most problems by following the recommended installation and maintenance procedures outlined in this User Guide. If you do have a problem, this section will help you determine what caused it and how to fix it.

Before you start disassembling the HTC process air heater be sure to:

❑ **Diagnose causes from the control panel.**

- 1 Press the Acknowledge Alarm button to silence the alarm.**
- 2 Address the alarm message and fix the problem.**
- 3 Move the heater switch from Enable to Standby.**
- 4 Cycle the heater switch from Standby to Enable to restart normal control. If the alarm reappears the problem was not fixed.**

If the alarm is a **passive alarm** you will see **P** in the screen title display.

If the alarm is a **shut down alarm** you will see **A** in the screen title display.

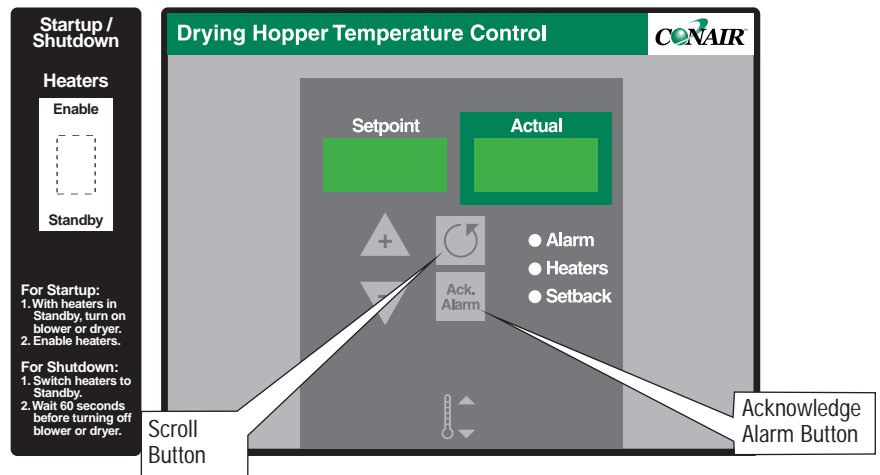

❑ **Diagnose causes from the control panel.**

You can locate any problem from the front of the heater.

Before Beginning (continued)





See warnings below. Open the control center to check fuses and heater contactors.

- ❑ **Find the wiring and equipment diagrams that were shipped with your heater.** These diagrams are the best reference for correcting a problem. The diagrams also will note any custom features, such as special wiring or alarm capabilities, not covered in this User Guide.

A Few Words of Caution

The HTC process air heater is equipped with numerous safety devices. Do not remove or disable them. Improper corrective action can lead to hazardous conditions and should never be attempted to sustain production.

 **WARNING:** Only qualified service personnel should examine and correct problems that require opening the dryer's control center or using electrical wires to diagnose the cause.

 **WARNING:** High voltage. Always stop the HTC process air heater, disconnect and lock out the main power source before troubleshooting or performing repairs.

 **CAUTION:** Hot surfaces. Always protect yourself from hot surfaces inside and outside of the heater.

How to Identify the Cause of a Problem

Most heater malfunctions are indicated by an illuminated Alarm light on the HTC process air heater control panel.

A problem can trigger two types of alarms:

- **Shut Down:** The heater has automatically shut down because it detected a serious problem that could damage your material or dryer.
- **Passive:** The heater continues to operate, but warns of a problem that could prevent correct heating of your material. If ignored, this problem could lead to a condition that will shut down the dryer.

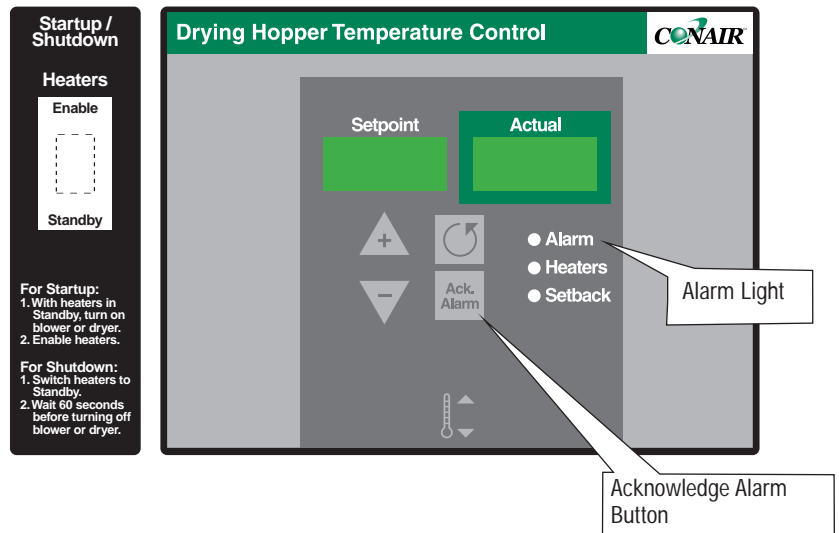

When the alarm light is displayed:

- 1 Press the Acknowledge Alarm button to silence the alarm** (see page 4-2).
- 2 Find the error message in the diagnostics table** of this Troubleshooting section.
- 3 Cycle the heater switch from Enable to Standby and then back to Enable to clear and restart normal control.** If the alarm reappears, the problem was not fixed.

Shut Down Alarms

If the red Acknowledge Alarm LED is solid, the alarm is a shutdown alarm. The heater will shutdown automatically to prevent damage to the equipment or personnel.

Problem

A1 Process High Temperature – If the process temperature exceeds the process high temperature setpoint, it shuts down the dryer. Defaults are set to 385°F (196.1°C) for 20 sec. for CP HTCs, and 360°F (182.2°C) for 20 sec. for HADs.

A2 Process Temperature Loop Break – If the process temperature is outside of the operator entered deviation, alarm band (see Process High Temperature Deviation passive alarm) and the process temperature is not moving towards the setpoint at a rate greater than specified. It shuts down the dryer. Defaults are set at 3°F (1.7°C) over 20 sec.

Possible cause

The process high temperature is not at least 10°F (5.6°C) above the setpoint.

The RTD temperature probe is not installed correctly.

The air lines are restricted or loose.

SSR has failed.

Output on the board has failed.

Process RTD is loose or has fallen out.

The process heater has failed.

The air lines are restricted or loose.

Output on the board failed “Open”.

Drying or setback setpoint is too low.

Solution

Increase the process high temperature.

Make sure the RTD temperature probe tip is in the center of the hopper inlet tube.

Straighten any crimps in the hoses. Tighten any loose hoses.

Replace the SSR.

Replace the board.

Check the process RTD and tighten if needed.

Check the heater fuses, and resistance across each leg of the process heater.

Straighten any crimps in the hoses. Tighten any loose hoses.

Replace the board.

Adjust the setpoint.

Add additional cooling, either a pre-cooler or an aftercooler, to the circuit.

(continued)

Shut Down Alarms (continued)

Problem	Possible cause	Solution
A3 Process Heater High Temperature – The snap switch in the process heater tube opens due to excessive temperature.	There is an air flow blockage or loose hoses.	Remove the blockage. Tighten any loose hoses.
	The isolation contactor failed in the closed position.	Replace the isolation contactor.
	The heater solid state relays (SSRs) failed.	Replace the failed heater solid state relays (SSRs).
	No air flow or the airflow is reversed.	Turn on the blower. Reverse the connection points of the hoses.
		Check the operation of the differential pressure switch.
A10 RTD Integrity – If a RTD is faulty.	The connection in the electrical enclosure for the RTD is loose.	Check the RTD plug connection and tighten if needed.
	The connection of the RTD plug on the control board is loose.	Check the plug connection and tighten if needed.
	One of the RTDs has failed.	Replace the RTD.
A39 EEPROM Write Error.	The RTD is enabled but wired incorrectly.	Move the wires to the proper terminals (see the wiring diagrams supplied with the unit).
	Internal control board problem.	Replace the control board.

Shut Down Alarms (continued)

Problem

A49 Process Protection High Temperature – If the process protection temperature exceeds the process protection high temperature setpoint, it shuts down the dryer. Defaults are set to 600°F (315.6°C) for 10 sec. for larger HTC's and 400°F (204.4°C) for 10 sec. for smaller HTC's.

A50 Process Protection Differential Temperature – If the process protection differential temperature exceeds the process protection differential temperature setpoint, it shuts down the dryer. Defaults are set to 175°F (325°C) for 180 sec. (see screen 21, page 4-12).

Possible cause

The Process RTD temperature probe is not installed correctly.

The air lines are restricted or loose.

The Process RTD or Process Protection RTD temperature probe is not installed correctly.

The air lines are restricted or loose.

Solution

Make sure the RTD temperature probe tip is in the center of the hopper inlet tube or heater manifold.

Straighten any crimps in the hoses.
Tighten any loose hoses.

Make sure the RTD temperature probe tip is in the heater outlet (see page 3-10).

Straighten any crimps in the hoses.
Tighten any loose hoses.

Passive Alarms

If the red Alarm LED is blinking, the alarm is a passive alarm. The heater continues to operate, but this problem could prevent correct heating of your material. Note that once the Acknowledge Alarm button is pressed once, the blinking red LED becomes solid. A passive alarm will go away when the alarm condition is cleared.

Problem

P1 Process Temperature Deviation – The process temperature exceeds the deviation band as entered for the specified time. Default values are 10°F (6°C) for 5 sec.

Possible cause

- One of the solid state relays (SSRs) has failed.
- The process RTD is loose or has fallen out.
- The air hose connections are loose.
- The heater has failed.

Solution

- Replace the failed solid state relays (SSR).
- Check the process RTD and tighten if needed.
- Tighten all air hose connections.
- Replace the failed heating element (see page 6-12).

Replacing Fuses

1 **Disconnect and lockout the main power supply.** 

2 **Open the control center.**



Fuse Blocks

To locate the appropriate fuse and replacement part, refer to the wiring diagrams that came with your HTC.

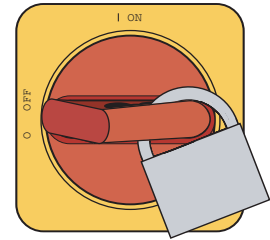

IMPORTANT: Always refer to the wiring diagrams that came with your heater to locate specific electrical components. Illustrations in the User Guide are intended to be representative only.

3 **Check the fuse.** If necessary, pull the fuse out and replace it with a fuse of the same type and rating.



Checking Heater Solid State Relays

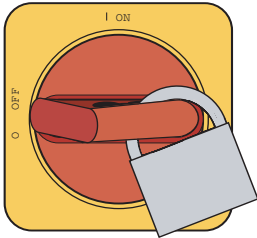

1 Disconnect and lockout the main power supply.



2 Open the control center door.

3 Locate the process solid state relays (SSRs). Refer to the wiring diagrams that came with your heater.

4 Check the resistance using an ohmmeter.



IMPORTANT: Always refer to the wiring diagrams that came with your heater to locate specific electrical components. Illustrations in the User Guide are intended to be representative only.

Solid state relays

Check the resistance between the terminal screws. If ohms equal zero, replace the relays.

Terminal Screws



Checking or Replacing Temperature Sensors

The HTC process air heater uses RTD sensors to monitor the process temperature in the hopper inlet, the setback temperature in the hopper outlet, and the process protection temperature in the heater outlet.



Typical location of the Process RTD at the hopper inlet.



IMPORTANT: Always refer to the wiring diagrams that came with your heater to locate specific electrical components. Illustrations in the User Guide are intended to be representative only.

To check or replace an RTD sensors:

- 1 Disconnect and lockout the main power supply.** 
- 2 Locate the RTD sensors.**
- 3 Check the sensor positions and conditions.** Temperature readings will be incorrect if the sensors are touching the wall of an air hose or pipe or if the sensor or wiring is damaged. The tip of the sensor should be centered within the air hose or pipe. Sensor wires should be attached to the appropriate connection points on the heater's control center.
- 4 To check with ohm meter,** measure the resistance across the RTDs. The resistance should be approximately 110 ohm at room temperature.
- 5 Replace the sensor, if necessary.**

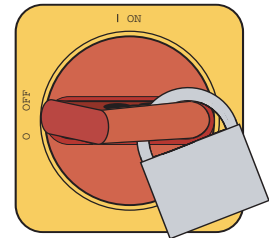

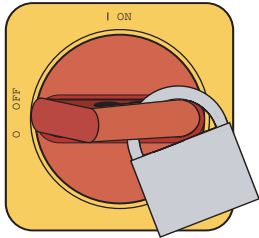

Replacing the Heating Elements

1 Disconnect and lockout the main power.



2 Gain access to the heating elements by removing screws that secure the heating element cover to the enclosure.



3 Remove the heating element cover by tilting the top away from the enclosure slightly, then lifting the cover up and away from the enclosure.



4 Refer to the “Testing the Installation” section (page 3-13) and determine which heater(s) is not functioning.



IMPORTANT: Always refer to the wiring diagrams that came with your heater to locate specific electrical components. Illustrations in the User Guide are intended to be representative only.

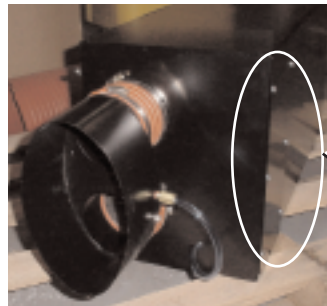

5 Remove the screws securing the electrical cover plate to the heating element enclosure. Remove the electrical cover plate.

Screws to Remove
- Large Heaters

6 Note the connection points then disconnect the heating element leads from the terminals on the terminal block.

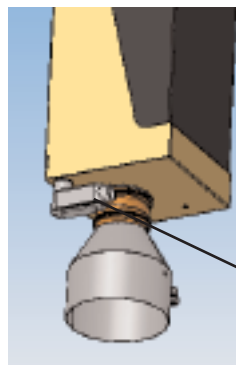

Heater
Connection
Junction Box

Heater
Wires

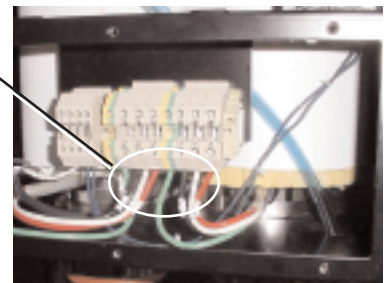

Replacing the Heating Elements (continued)

Note: For larger units (above 60 kW), it may be necessary to remove the front heaters to access the rear heaters.

7 Remove the hose clamp securing the insulated hose to the outlet of the heating element. Remove the hose.

8 Remove the hose clamps securing the heating element to the heater inlet.

9 Remove the internal hose clamp.

10 Lift the heating element out of the enclosure.

11 Slide the insulation off the heater, or make a cut the entire length of the insulation sleeve to aid removal.

12 Check the ID mark on the side of the heating element for kW rating and voltage. The ID mark is on the outside of the tube near the end with the lead wires. Make sure the kW and voltage is the same as the replacement heating element.

13 Slide the original insulation over the new heater or, if the insulation was cut for removal, wrap the cut insulation sleeve around the new heater and secure it with duct tape.

14 Set the new heating element into the enclosure. Secure the heating element to the heater inlet with the original three (3) hose clamps.

15 Connect the insulated outlet hose to the outlet of the heating element. Secure the hose with the original hose clamp.

16 Route the heating element leads to the terminal block. Connect the heating element leads to the original terminals on the terminal block. Reinstall the electrical cover plate.

17 Reinstall the heating element cover on the enclosure.

18 Test the system to insure that the new heating element is functioning correctly (see Page 3-13, Step 3).

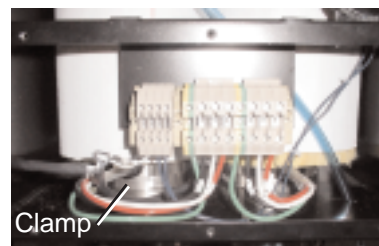
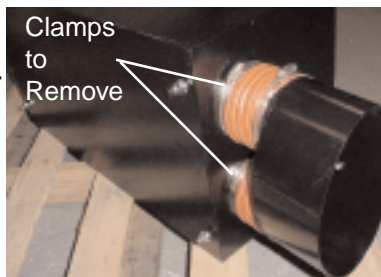

Replacing the Air Flow Differential Pressure Switch

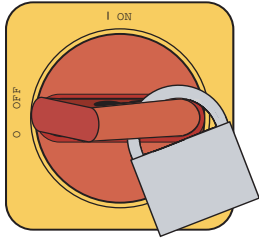

If the air flow differential pressure switch fails to detect the pressure drop between the heater inlet and outlet, it should be replaced.

1 Stop the heater, disconnect and lockout the main power.



2 Gain access to the heating elements by removing screws that secure the heating element cover to the enclosure.



IMPORTANT: Always refer to the wiring diagrams that came with your heater to locate specific electrical components. Illustrations in the User Guide are intended to be representative only.

3 Remove the heating element cover by tilting the top away from the enclosure slightly, then lifting the cover up and away from the enclosure.



4 Note their location then remove the two wires connected to the pressure switch.

5 Note their locations then disconnect the hose coming from the heater outlet from the low pressure side of the switch and the hose coming from the heater inlet from the high pressure side of the switch.



Replacing the Air Flow Differential Pressure Switch (continued)

6 Remove the mounting hardware securing the pressure switch to the heating element enclosure.

7 Align the new pressure switch with the mounting holes and secure it to the heating enclosure using the original mounting hardware.

8 Connect the hose coming from the heater outlet to the low pressure side of the switch and the hose coming from the heater inlet to the high pressure side of the switch.



9 Connect the two wires to their original location on the pressure switch.

10 Test the system to insure that the new air flow differential switch is detecting the pressure drop between the heater inlet and outlet.

11 Reinstall the heating element cover on the enclosure.

12 Connect the hose coming from the heater outlet to the low pressure side of the switch and the hose coming from the heater inlet to the high pressure side of the switch.

13 Connect the two wires to their original location on the pressure switch.

14 Test the system to insure that the new air flow differential switch is detecting the pressure drop between the heater inlet and outlet.

We're Here to Help

Conair has made the largest investment in customer support in the plastics industry. Our service experts are available to help with any problem you might have installing and operating your equipment. Your Conair sales representative also can help analyze the nature of your problem, assuring that it did not result from misapplication or improper use.

Additional manuals and prints for your Conair equipment may be ordered through the Customer Service or Parts Department for a nominal fee, or visit the product section of the Conair website www.conairnet.com.

How to Contact Customer Service

To contact Customer Service personnel, call:



 **NOTE:** Normal operating hours are 8:00 AM - 5:00 PM. After hours emergency service is available at the same phone number.

From outside the United States, call: 814-437-6861

You can commission Conair service personnel to provide on-site service by contacting the Customer Service Department. Standard rates include an on-site hourly rate, with a one-day minimum plus expenses.

Before You Call...

If you do have a problem, please complete the following checklist before calling Conair:

- Make sure you have all model, control type from the serial tag, and parts list numbers for your particular equipment. Service personnel will need this information to assist you.
- Make sure power is supplied to the equipment.
- Make sure that all connectors and wires within and between control systems and related components have been installed correctly.
- Check the troubleshooting guide of this manual for a solution.
- Thoroughly examine the instruction manual(s) for associated equipment, especially controls. Each manual may have its own troubleshooting guide to help you.
- Check that the equipment has been operated as described in this manual.
- Check accompanying schematic drawings for information on special considerations.

Equipment Guarantee

Conair guarantees the machinery and equipment on this order, for a period as defined in the quotation from date of shipment, against defects in material and workmanship under the normal use and service for which it was recommended (except for parts that are typically replaced after normal usage, such as filters, liner plates, etc.). Conair's guarantee is limited to replacing, at our option, the part or parts determined by us to be defective after examination. The customer assumes the cost of transportation of the part or parts to and from the factory.

Performance Warranty

Conair warrants that this equipment will perform at or above the ratings stated in specific quotations covering the equipment or as detailed in engineering specifications, provided the equipment is applied, installed, operated and maintained in the recommended manner as outlined in our quotation or specifications.

Should performance not meet warranted levels, Conair at its discretion will exercise one of the following options:

- Inspect the equipment and perform alterations or adjustments to satisfy performance claims. (Charges for such inspections and corrections will be waived unless failure to meet warranty is due to misapplication, improper installation, poor maintenance practices or improper operation.)
- Replace the original equipment with other Conair equipment that will meet original performance claims at no extra cost to the customer.
- Refund the invoiced cost to the customer. Credit is subject to prior notice by the customer at which time a Return Goods Authorization Number (RGA) will be issued by Conair's Service Department. Returned equipment must be well crated and in proper operating condition, including all parts. Returns must be prepaid.

Purchaser must notify Conair in writing of any claim and provide a customer receipt and other evidence that a claim is being made.

Warranty Limitations

Except for the Equipment Guarantee and Performance Warranty stated above, Conair disclaims all other warranties with respect to the equipment, express or implied, arising by operation of law, course of dealing, usage of trade or otherwise, including but not limited to the implied warranties of merchantability and fitness for a particular purpose.

Blower Installation and Maintenance

This addendum will assist you in installing and maintaining your HAD blower. By following the general instructions presented, you will prolong the life of the equipment, while preventing unexpected downtime.



Note: This addendum applies only if you have purchased a Conair Hot Air Dryer (HAD).

Receiving

All shipments are F.O.B. It is, therefore, in the interest of the buyer to carefully inspect all shipments before they are accepted from the freight carrier. Upon delivery, be sure that all items listed on the bill of lading and packing list (inserted in the plastic envelope attached to the shipment) have been received. Partial shipments are sometimes made.

The units are skidded, boxed, or crated to fully comply with rail or trucking requirements for shipment. Accessories are sometimes shipped separately due to handling space requirements.

Although all equipment is carefully inspected and prepared for shipment at the factory, damage to the fan and/or drive parts may occur due to rough handling during shipment.

Any shortage, breakage, or damage noticed at time of delivery should be indicated to the carrier's representative. Damage noticed after delivery should be reported to the carrier at once. Request their inspection of the shipment and fill out a concealed damage inspection report.

Handling

Small units should be handled carefully and lifted only by the base, never by the shaft, coupling, motor, or housing. Large units should be lifted by the base or by the lifting eyes. Precautions should be taken to avoid dropping or jarring the equipment as this can cause damage to the shaft or wheel, which is not visibly noticeable, but can cause vibration problems.

Installation

 **TIP: Extended Storage** - Units that will be held in storage for a period of up to two (2) years should have special provisions so operation-readiness can be maintained. Motors should be equipped with internal space heaters kept on continuously. Units should be crated and covered with polyethylene film. In addition, impellers should be hand-rotated once a month. For best results, keep the units sheltered in a cool, dry location.

Fans and motors should be mounted on structurally sound foundations. Concrete is the best, however, other types designed properly are acceptable. Equipment should be leveled on the foundation and shimmed or grouted in place. This will prevent putting the fan structure into a bind by bolting it down on an uneven surface.

As a general rule, if vibration isolators are used, the fan should first be bolted to a structural steel base and the isolation takes place between the structural steel base and the foundation. This prevents the fan base from floating due to uneven weight distribution and/or drive forces when mounted directly to vibration isolators.

Wiring the Starter

The electrical connection consists of bringing power to the starter on the blower assembly. The incoming power should match the rated nameplate power required on the serial tag on the blower. This power should be clean and have a voltage variation of no more than +/- 5% of the nameplate voltage.



CAUTION: Always disconnect and lock out the main power sources before making electrical connections. Electrical connections should be made only by qualified personnel.



CAUTION: Check the disconnect with a volt meter to insure that the power is off.

- 1 Disconnect and lock out the main power sources before making electrical connections.** Electrical connections should be made only by qualified personnel.
- 2 Remove the cover from the main power control box on the blower assembly.**
- 3 Route the main power cable through the power control box.** Secure the power cable with a rubber compression fitting or strain relief, or use conduit. Verify that the incoming power is securely attached to the blower assembly and there is no strain on the incoming power wires.
- 4 Connect the power wires** to the three terminals on the upper side of the starter power disconnect.
- 5 Connect the ground wire** to the ground lug.

Power Wires
(Black- Customer
Supplied)

Ground Wire
(Green - Customer
Supplied)

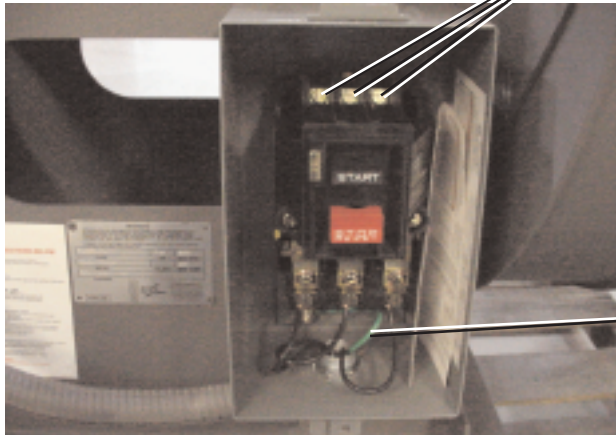

IMPORTANT: Always refer to the wiring diagrams that came with your blower before making electrical connections.



Note: The connections at the starter should be made with properly sized conductors and properly protected with appropriate conduit. The routing should be neat and away from potential mechanical damage. The terminations should be landed on the terminals on the starter. These terminations should be regularly checked to prevent loosening and shorting to ground.

Before Start-up

Before start-up, the following should be verified.

- 1 Fasteners** - All foundation bolts, wheel hub setscrews, wheel locking bolts, and bearing locking collars must be tight.
- 2 Bearings** - Check the bearings and make certain they are properly lubricated.
- 3 Fan Wheel** - Turn over the rotating assembly by hand to insure that it runs free and does not bind or strike the fan housing. If the wheel strikes the housing, the wheel may have to be moved on the shaft.
- 4 Motor** - Check the electrical wiring to the motor. The current characteristics of the supply line must agree with the motor nameplate rating. The motor should be wired and fused in accordance with the National Electric Code (NEC) and local codes.
- 5 Ducts** - Duct connections from the fan to the duct work must not be distorted. Ducts should never be supported by the fan. All duct joints should be sealed to prevent air leaks. All debris should be removed from the ductwork and the fan.
- 6 Resistance Check** - Check the resistance leg to leg and leg to ground to make sure that the starter is wired correctly. The three legs should have equal resistance +/- 5%. The resistance to ground should be 20 megohms or higher.



IMPORTANT: Always refer to the wiring diagrams that came with your blower before checking electrical connections.

Start-up

- 1 Using the Start/Stop button, "Jog" the motor to check for proper wheel rotation.** The motor should be started in accordance with the manufacturer's recommendations. Arrows on the fan indicate the proper direction of rotation and airflow.

Start/Stop Button

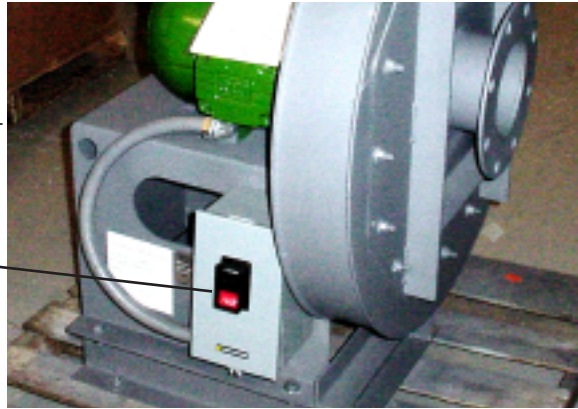

- 2 Throttle the blower discharge damper ¼ open.** (It is shown fully open in this photo.)

- 3 The fan may now be brought up to speed.** Watch for anything unusual such as vibration, overheating of bearings and motor, etc.

- 4 Throttle the discharge damper until the pressure is 15-20" WC.**

- 5 Check the motor amperage against the nameplate amperage to make sure the motor is not overloading.**



Balance and Vibration

All fan impellers are dynamically balanced prior to installation in the fan assembly. After assembly, fans supplied with motors are test run and fine-tune balanced to reduce vibration levels to acceptable limits as shown in table below (from AMCA Standard 204-96).

After field installation, fans will need to be checked prior to commissioning to assure that the vibration levels do not change significantly from those achieved at the factory. It is recommended that the velocity values in the table below are not exceeded by more than 10% when field installed.

Fan Application Category	Rigid Mounted mm/sec (in./sec)	Flexible Mounted mm/sec (in./sec)
BV-3	3.8 (0.15)	5.1 (0.20)

The installed vibration level of any fan is not solely dependent on the balance grade. Installation factors such as the mass and stiffness of the supporting system will influence the "as installed" vibration level (refer to AMCA Publication 202, Troubleshooting).

General Maintenance

- 1 Inspection** - A definite time schedule for inspecting all rotating parts and accessories should be established. The frequency of inspection depends on the severity of operation and the locality. Inspections might be weekly at first in order to set up the schedule.
- 2 Alignment** - The shaft must not be cocked in the bearings. Misalignment can cause overheating, wear to dust seals, bearing failure, and vibration.
- 3 Hardware** - Check the tightness of all bolts and setscrews.
- 4 Lubrication** - Check the fan and motor bearings and add lubricant if necessary. Be careful not to over grease as this can damage bearing seals.
- 5 Air Flow** - Make sure there is no debris or unnecessary obstructions to air-flow in the outlet or inlet ductwork.
- 6 Bearings** - On high-speed fans, the bearings tend to run hot. Therefore, do not replace a bearing because it feels hot to the touch. Place a pyrometer or contact thermometer against the pillow block and check the temperature. Pillow block and flange mount bearings can have housing surface temperatures of 200°F (93°C) before the cause of overheating should be investigated.
- 7 Wheel** - Inspect the wheel blades for accumulation of dust and dirt. Clean thoroughly with a stream of water jet, compressed air, or a wire brush. This will help prevent an unbalanced condition. If the blades are aluminum, be careful not to damage them. Cover the bearings so water does not enter the pillow block. The wheel should have proper clearances to prevent the blades from striking the housing. Make sure the wheel is rotating in the proper direction. Never run the fan at a higher speed or temperature than is shown on the fan nameplate. Contact Conair with any questions.



CAUTION: Wear eye protection. If you use compressed air to clean the equipment, **you must wear eye protection** and observe all OSHA and other safety regulations pertaining to the use of compressed air.

Fan Bearing Maintenance

For most applications, a lithium base grease (such as Mobilith AW2) conforming to a NLGI Grade 2 consistency should be used. This type of grease inhibits rust, is water resistant, and has a temperature range of -30 to 200°F (-34.3 to 93.3°C), with intermittent highs of 250°F (121°C). For extreme duty and higher temperature applications, use Mobilith SHC220 synthetic hydrocarbon grease.

When greasing bearings, it is important not to over-grease. This is especially true if the bearings are equipped with extended grease lines and the bearings are not visible. In this case, more bearing failures occur due to over-greasing than under-greasing. It is best to give the bearing just one "shot" of grease periodically if the bearings are not visible. When the bearings are visible, pump in grease until a small bead of grease forms around the bearing seals. It is very important that fan bearing greasing take place while the fan is operating.



CAUTION: Caution should be taken while working on and near rotating equipment to avoid personal injury.

Motor Maintenance

Lubricate the motor bearings to the manufacturer's recommendations.

Lubrication recommendations are included with the packet attached to the fan.

Should this packet be missing, the following will apply:

Integral Horsepower Ball Bearings Motors: Motors having pipe plugs or grease fittings should be re-lubricated while warm and at standstill. Replace one (1) pipe plug on each end shield with a grease fitting. Remove the other plug for grease relief. On low pressure, grease, run, and lubricate until the new grease appears at the grease relief. Allow the motor to run for ten (10) minutes to expel any excess grease. Replace the pipe plugs. Motors not having pipe plugs or grease fittings can be re-lubricated by removing the end shield, cleaning the grease cavity, and refilling three-fourths or circumference of the cavity.

Recommended Re-lubrication Intervals (General Guide Only)

Horse Power Range	Standard Duty 8 hr/day	Severe Duty 25 hr/day Dirty-Dusty	Extreme Duty Very Dirty High Ambients
1.5 - 7.5	5 yrs.	3 yrs.	9 mos.
10 - 40	3 yrs.	1 yr.	4 mos.
50 - 150	1 yr.	9 mos.	4 mos.

Recommended Motor Greases

Polyrex EM - Exxon Oil Company
SRI #2 - Chevron Oil Company

Vibration Level of Replacement Impellers

All replacement impellers are dynamically balanced by the manufacturer prior to shipment. Occasionally, an impeller that has been factory-balanced will yield poor balance/vibration results when installed and operated. This does not mean that the impeller was incorrectly balanced at the factory. It can result from differences between test-stand conditions and operating conditions. A factory test stand has different bearings, bearing spans, structural response, stiffness, mechanical impedance, and by necessity, running speeds. The test stand cannot duplicate the actual "fan system" and its response. For these reasons, the "fan system" vibration levels must be checked after installing a replacement impeller. Refer to the "Balance and Vibration" section for acceptable vibration levels.

Blower Troubleshooting

In the event that trouble is experienced in the field, the following Troubleshooting Table lists the most common blower difficulties. These points should be checked before contacting Conair Customer Service.

Problem

The blower does not meet capacity or pressure ratings.

Excessive vibration and/or noise.

Possible cause

Total resistance of system is higher than anticipated.

Dampers or variable inlet vanes are not properly adjusted.

Poor fan inlet or outlet conditions.

Air leaks in system.

Damaged wheel.

Incorrect direction or rotation.

Unstable foundation, fan bolted to an uneven foundation, not shimmed or grouted properly.

Foreign material in fan causing unbalance.

Solution

Reduce the system restrictions by shortening the hoses, reducing the number of turns, and/or increasing the plenum size.

Open the damper to increase the flow; close the damper to decrease flow.

Clear all obstructions from the air inlet and outlet.

If an inlet filter is used, clean or replace the filter as needed.

Seal all possible air leaks in the system.

Replace the damaged wheel.

Reverse the electrical connections at the motor.

Reinstall the unit following the installation instructions detailed in the "Installation Instructions" on page AD-2.

Clean the fan and fan housing.

(continued)

Blower Troubleshooting (continued)

Problem	Possible cause	Solution
Excessive vibration and/or noise (continued).	Worn bearings.	Replace the worn bearings.
	Damaged wheel or motor.	Replace the damaged wheel and/or motor.
	Broken or loose bolts and setscrews.	Tighten or replace all loose bolts and/or setscrews as needed.
	Bent shaft.	Replace the motor.
	Fan wheel or driver unbalanced.	Balance the wheel or driver following factory instructions.
	120 cycle magnetic hum due to electrical input.	Check for high or unbalanced voltage.
	Fan delivering more than rated capacity.	Reduce the flow by throttling the discharge damper.
	Loose dampers or variable inlet vanes.	Tighten any loose dampers or inlet vanes.
	Fan rotation in wrong direction.	Reverse the electrical connections at the motor starter.
Vibration transmitted to the fan from some other source.	Make sure the fan is properly isolated from the rest of the system.	

Blower Troubleshooting (continued)

Problem	Possible cause	Solution
Overheated bearings.	Too much grease.	Remove and excess grease (see "Fan Bearing Maintenance" [page AD-8] and "Motor Maintenance" [page AD-9] for lubrication instructions).
	Damaged wheel or driver.	Replace the damaged wheel or driver.
	Bent shaft.	Replace the motor.
	Abnormal end thrust.	Make sure all spacers and shims are in good condition. Replace as necessary.
	Dirt in bearings.	Clean and lubricate the bearings (see "Fan Bearing Maintenance" [page AD-8] and "Motor Maintenance" [page AD-9] for lubrication instructions).

Ordering Spare Parts

Contact Conair's Parts Department and supply the following information:

- 1** Conair order number/serial number.
- 2** Fan serial number stamped on nameplate.
- 3** Fan code and model stamped on nameplate.
- 4** Fan arrangement.
- 5** Description of the part required.
- 6** Part number, if the part is a casting.
- 7** Special materials, paints, and / or coatings.

Wheel: Be sure to indicate direction of rotation as viewed from drive side, type of wheel, and the operating speed.

Shaft: Length and diameter.

Motors: The name of the motor manufacturer, motor model number, and serial number from the motor nameplate must be supplied to Conair for repairs or replacement.

Specifications: Hot Air Dryer (HAD) Blower

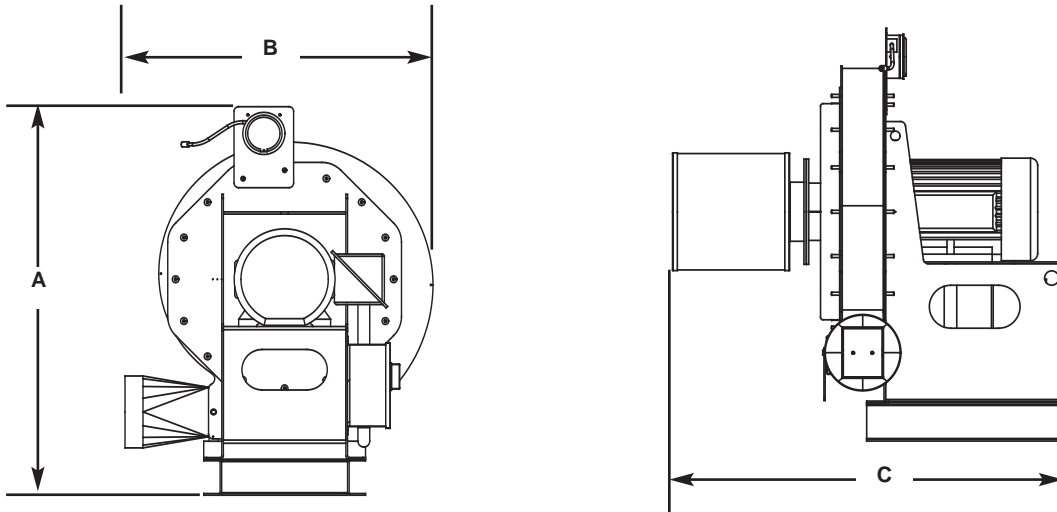

Hot Air Dryer model (HAD)	600	800	1000	1600	2400	3200	5000
RECOMMENDED MODEL HTC*	HTC-30B†	HTC-30B†	HTC-30A†	HTC-60A†	HTC-90A†	HTC-120A†	HTC-120A†
Performance characteristics							
Flow rate cfm	300	400	500	800	1200	1600	2500
Disc. pressure @flow rate inches WC‡	25	32	30	30	28	30	33
{mm} WC‡	{635}	{813}	{762}	{762}	{711}	{762}	{838}
Motor Hp kW	5 {3.7}	7.5 {5.6}		7.5 {5.6}	10 {7.5}	15 {11.2}	25 {18.6}
Dimensions inches {cm} and weight lb {kg}							
Outlet size selection (OD)	5	5	8	8	8	8	12
A - Height	42 {107}	42 {107}	42 {107}	42 {107}	42 {107}	42 {107}	42 {107}
B - Width	33 {84}	33 {84}	33 {84}	33 {84}	33 {84}	33 {84}	33 {84}
C - Length	39 {99}	39 {99}	42 {107}	42 {107}	42 {107}	80 {203}	82 {208}
Weight							
Installed weight lb {kg}§	250 {113}	320 {145}	380 {172}	500 {227}	700 {317}	900 {408}	
Voltage Full Load Amps							
400V/3 phase/50 Hz	9.1	13.2	13.2	16.8	25.2	40.8	
460 V/3 phase/60 Hz	7.6	11	11	14	21	34	
575 V/3 phase/60 Hz	6.1	9	9	11	17	27	
Noise level							
with standard soundproofing	< 90 dbA @ 5 ft.						

TPDM024-0106

SPECIFICATION NOTES:

* For single hopper system.

† The HTC model number reflects the kilowatts of each unit. For example, HTC-60 has a 60 kilowatt heater.

‡ The unit of measure WC is water column.

§ Weights are approximate.

Specifications may change without notice. Consult a Conair representative for the most current information.

Free Manuals Download Website

<http://myh66.com>

<http://usermanuals.us>

<http://www.somanuals.com>

<http://www.4manuals.cc>

<http://www.manual-lib.com>

<http://www.404manual.com>

<http://www.luxmanual.com>

<http://aubethermostatmanual.com>

Golf course search by state

<http://golfingnear.com>

Email search by domain

<http://emailbydomain.com>

Auto manuals search

<http://auto.somanuals.com>

TV manuals search

<http://tv.somanuals.com>