



SV-6400 ClipCam

INSTALLATION MANUAL

SAFETY PRECAUTIONS

- ⌘ Make sure to read the “Installation Manual” for safety precautions before installing unit or accessories.
- ⌘ Please make sure the vehicle is well parked in a safe place. Make sure that the engine and the power are switched off.
- ⌘ Avoid installation outdoors during rain or thunder storms.
- ⌘ The instructions presented in this manual are based on the passenger seat at the right of the driver’s seat. In an opposite situation, change the directions accordingly.
- ⌘ Objects on the monitor are closer than they appear.
- ⌘ This ClipCam camera is not a safety device. Safe driving is the driver’s responsibility in all circumstances.

NOTICE-DISCLAIMER

Under no circumstances shall the manufacturer or distributor of the ClipCam be held liable for consequential or incidental damages sustained in connection with the use of the ClipCam rear vision system. The ClipCam is designed as a safety enhancement device and is in no way intended as a replacement for rear-view mirrors, side-view mirrors or physically checking the surroundings when backing a vehicle. Always check surroundings for safety when backing. Objects on the monitor are closer than they appear. For the best fit, modification of the vehicle license may or may not be necessary. It is the sole responsibility of the vehicle owner to check and verify any and all state or federal motor vehicle codes with regard to modifications of vehicle license plates.

Compilation and Publication Notice

Under the supervision of PEC, this manual has been compiled and published, covering the latest description and specification. The contents of this manual and the specifications of this product are subject to change without notice. PEC reserves the right to make changes without notice in the specification and material contained herein and shall not be responsible for any damages (including consequential) caused by reliance on the materials presented, including but not limited to typographical and other errors relating to the publication.

PACKAGE CONTENTS

Check your package for the listed contents. If you do not find all of the listed items, contact the supplier from whom you purchased the camera before installing the unit and accessories.



(1) Clip Cam



(1) Camera Clip (small)



(1) Camera Clip (large)



(2) Screws



(1) 20' cable



(10) Cable Carpet Clips

?

INSTALLATION

Before installing the unit and accessories, read this manual in its entirety. The ClipCam is designed to work on most vehicles. However, there are some vehicles that we suggest you not use the ClipCam on due to difficulty in installation or improper viewing angles. Please refer to the following three diagrams of trunk lip profiles.

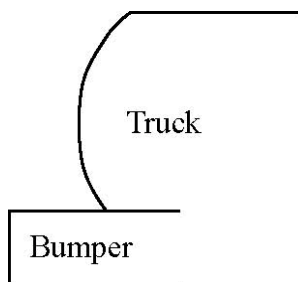

Outer Curved Trunk Lip

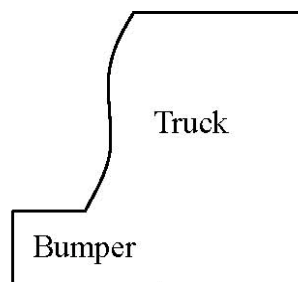

Inner Curved Trunk Lip

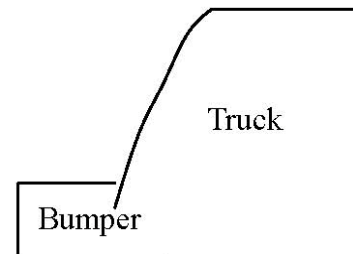

Trunk Lip Below Bumper

Step 1: Testing the Camera (Bench Testing)

1. Prepare two sets of DC 11-13V batteries for running a bench test to make sure the camera functions are working properly (before you actually install the camera into your vehicle).
2. Refer to the wiring diagram (4.1-3) the camera and the monitor each have to have their own power source, DO NOT connect with the same battery.
3. When connecting the 20' cable, make sure all connectors have been solidly connected.
4. Turn on the monitor and you should see a clear, color picture display.
5. If you do not see a picture or the picture quality is not satisfactory, please turn off the monitor and double check all the connectors to make sure they are securely connected.
6. Turn on the monitor again. If you are still unable to see the picture or the picture quality has not improved, contact your supplier for assistance.

Step 2: Checking the Power Source

1. The camera can only operate by connecting a power source of DC 11-13V / 70mA type.
2. Check your vehicle and make sure you have the correct power source for the camera.
3. In most cases, the camera power line is connected with the reverse light power source.

Step 3: ClipCam Installation

1. Your package includes camera clips in two sizes. Use the size that matches with the thickness of the vehicle's rear trunk lip. The small size clip ranges 1/4" (6 mm) and the larger size ranges from 1/4"(6 mm) up to 1/2" (12 mm) thickness.

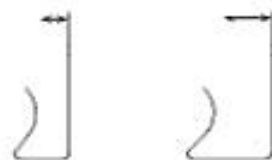

- When making your selection, choose the tighter fit of the 2 camera clips that are included.
- Insert the camera clip into the camera housing.

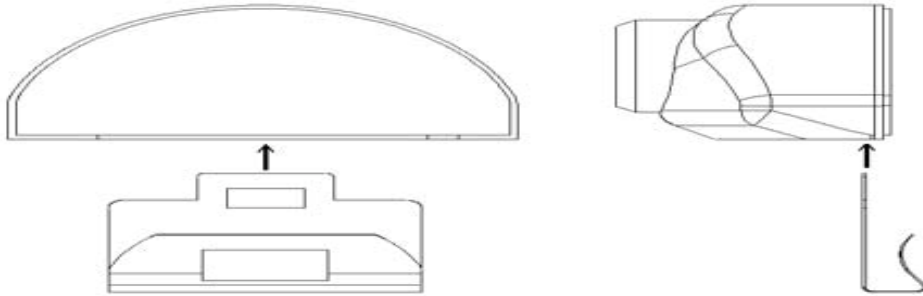

- If for any reason you need to change the camera clip size, please open the pre-cut window at the back side of the camera. Next, use a flat screw driver to lift up the camera clip enough to remove it from the camera housing. Change to the correct camera clip and reinsert into the camera housing. (Refer to the diagrams on the following page).

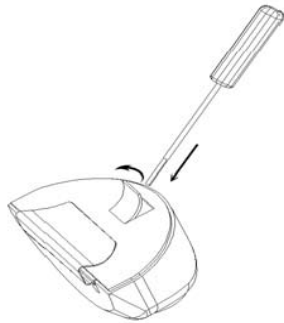

Diagram 4.A

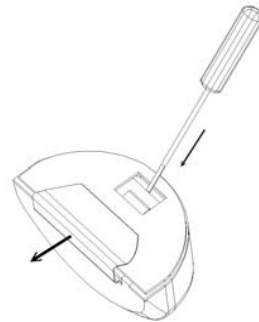
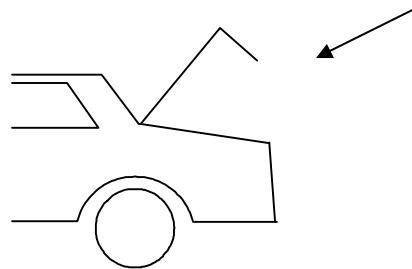

Diagram 4.B

- For better viewing angles, place the ClipCam at the center of the trunk lip.

Rear Trunk Lip



6. Optional installation: Sometimes the space between vehicle license plate and rear trunk lip area is very narrow, which may cause problems when installing the ClipCam. An adjustable bracket is available to deal with this problem. Install the adjustable bracket to move up the license plate until you have enough space to install the ClipCam.

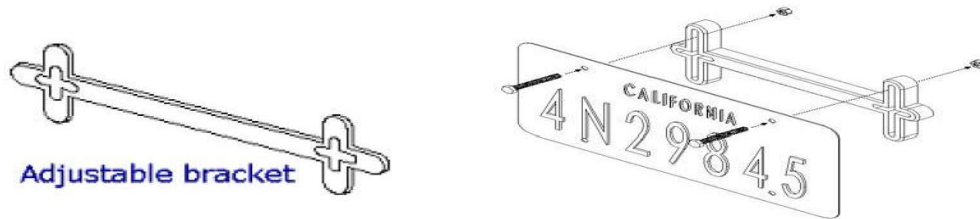

Step 4: Wire Connection

1. Connect the power source line to the camera. Also connect a 20' cable with monitor. (Refer to Diagram 4.1)

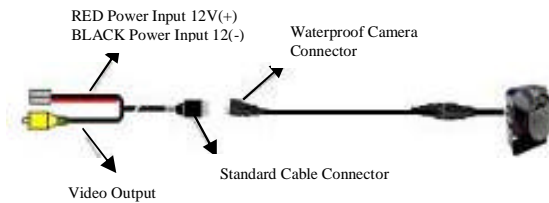
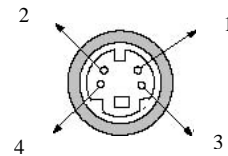

Diagram 4.1-1

4 pin connector



Pin No.	PART-DESC
1	Video Output
2	Power DC 12V
3	GND
4	

Diagram 4.1-2

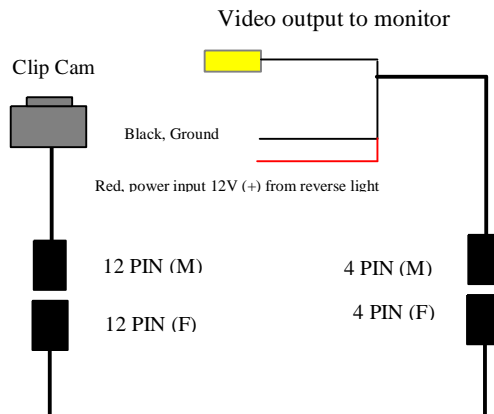

Diagram 4.1-3

2. In most cases and as a time saver, connect the camera power at the rear of vehicle behind the reverse lights. The red power wire line goes to the reverse light + 12 V and the black wire to ground.
3. Please carefully choose a hidden location to run the camera. Drilling a cable hole if necessary.
4. Please make sure to use the rubber grommet or plug to make a watertight seal for the cable where it passes into the vehicle body.
5. Please refer to the monitor wiring diagram. The monitor must be connected using its own power line and should not be connected to same power line with the camera.

Step 5: Test Run Your New Rear View Camera System

1. You have just completed the installation and wiring of your new rear view camera system.
2. Please make sure the vehicle is parked at a safe place before you do a test run.
3. Power up your vehicle and the monitor. Put the vehicle in reverse and the monitor should immediately display a clear, color picture.

Important: The rear view camera will be used when the vehicle is in reverse gear. If the monitor does not display a picture or the picture quality not satisfactory, please double check all cable connections. If you are unable to correct the problem, please contact your supplier for help.

Technical Specification

The following table defines the technical specifications for the SV-6400 ClipCam.

***Size :** 65 x 38 x 40 mm

***Weight :** 172.6 g

Number of effective pixels	NTSC: 512(H)*492(V) ; PAL:512(H)*582(V)
Sensor	1/4 inch - type CCD Sensor
Signal processor	Digital signal processor (D.S.P)
Resolution	>250,000 pixels
Digitalis	10 bit A/D Converter
Sync. System	Internal
Resolution	More than 330 TV line
Minimum illumination	3.0 LUX / F1.2
S/N ratio	More than 48dB
Gamma correction	0.45
Gain control	AGC
White balance	AUTO
Exposure	A.E: auto electronics shutter 1/60 s(1/50 s)~1/100000 s
Video output	1.0Vp-p composite video. 75(OHM) load
Power consumption	180mA, 2.4W(MAX)
Operation temp	-30 °C TO 75 °C
Storage temp	-40 °C TO 85 °C
Lens mount type	Wide-angle Board lens
Supply voltage	DC12V, 180mA(+/-10%)
Horizontal Angle	Minimum 98 °± 2°
Vertical Angle	Minimum 75 °± 2°
Diagonal Angle	145°
Housing	PC

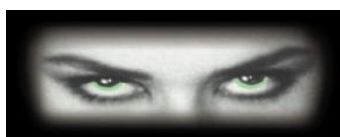

CRIMESTOPPER

1770 SOUTH TAPO STREET ✦ SIMI VALLEY, CALIFORNIA 93063
800-998-6880 ✦ 805-526-9400 ✦ FAX 805-581-9500
WWW.CRIMESTOPPER.COM

© 2005 CrimeStopper Security Products, Inc.

Free Manuals Download Website

<http://myh66.com>

<http://usermanuals.us>

<http://www.somanuals.com>

<http://www.4manuals.cc>

<http://www.manual-lib.com>

<http://www.404manual.com>

<http://www.luxmanual.com>

<http://aubethermostatmanual.com>

Golf course search by state

<http://golfingnear.com>

Email search by domain

<http://emailbydomain.com>

Auto manuals search

<http://auto.somanuals.com>

TV manuals search

<http://tv.somanuals.com>