



MP3



*We bring DVD Home!*  
**CyberHome**

Portable

# DVD Player

with

## Progressive Scan

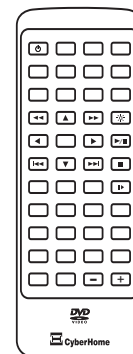
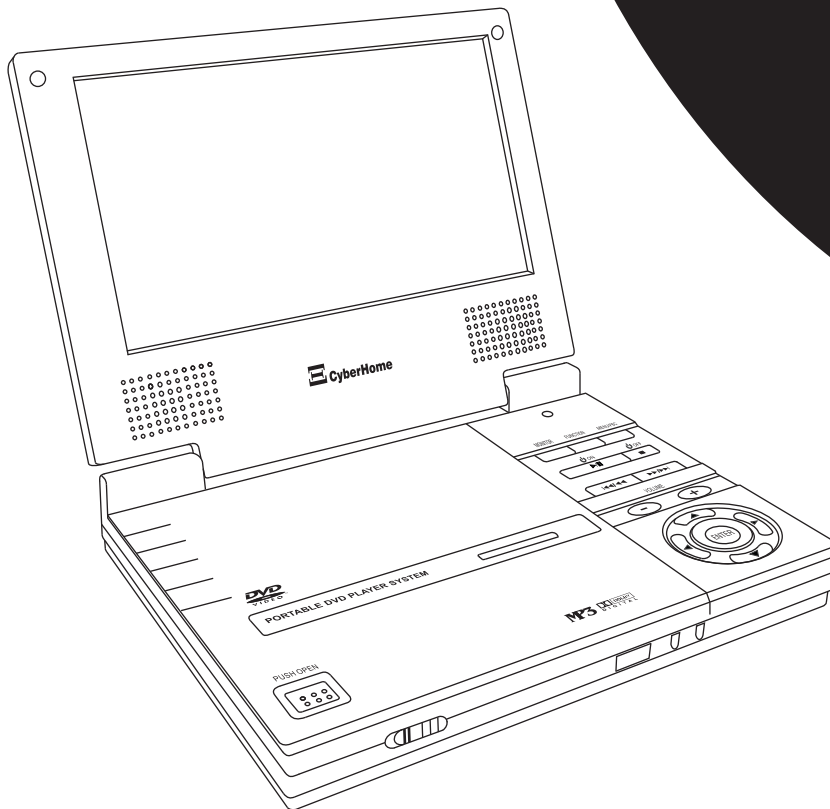

## Operation Guide

# CH-LDV 700B

# SAFETY INSTRUCTIONS



**CAUTION:** TO REDUCE THE RISK OF ELECTRIC SHOCK, DO NOT REMOVE THE COVER (OR BACK). NO USER-SERVICEABLE PARTS INSIDE. REFER TO QUALIFIED SERVICE PERSONNEL FOR SERVICING.

## Explanation of WARNING symbols



The lightning flash with arrowhead symbol, within an equilateral triangle, is intended to alert the user to the presence of not isolated dangerous voltage within the inside of the product that may be sufficient magnitude to constitute a risk of electric shock to persons.



The exclamation point within an equilateral triangle is intended to alert the user to the presence of important operating and servicing instructions in the literature accompanying the appliance.

## Read the following instructions carefully

**WARNING:** TO REDUCE THE RISK OF FIRE, ELECTRIC SHOCK OR ANNOYING INTERFERENCE, DO NOT EXPOSE THIS APPLIANCE TO RAIN OR MOISTURE AND ONLY USE THE RECOMMENDED ACCESSORIES.

- Use only with the cart, stand, tripod, bracket, or table specified by the manufacturer, or sold with the apparatus. When a cart is used, use caution when moving the cart / apparatus combination to avoid injury from tip-over. 
- Unplug this apparatus during lightning storms or when unused for long periods of time.
- Refer all servicing to qualified service personnel. Servicing is required when the apparatus has been damaged in any way, such as when the power-supply cord or plug is damaged, liquid has been spilled, objects have fallen into the apparatus, the apparatus has been exposed to rain or moisture, or when the unit does not operate normally, or has been dropped.
- Power cord protection - To avoid any malfunctions of the unit and to protect against electric shock, fire or personal injury, please observe the following:
  - a) Hold the plug firmly when connecting or disconnecting the AC power cord to this unit.
  - b) Do not connect or disconnect the AC power cord with wet hands.
  - c) Keep the AC power cord away from heating appliances.
  - d) Never put any heavy object on the AC power cord.
  - e) Do not attempt to repair or reconstruct the AC power cord in any way.
- Remove dust, dirt, etc. on the plug at regular intervals.
- If the unit has been dropped or otherwise damaged, turn off the power and disconnect the AC power cord.
- If smoke, odors or noises are emitted from the unit, turn off the power and disconnect the AC power cord.
- Placement - Avoid placing the unit in areas of direct sunlight, heating radiators, closed automobiles, high temperature (over 35° C (95° F)), high humidity (over 90%), excessive dust, vibration, impact or where the surface is tilted, as the internal parts may be seriously damaged.
- Non-use periods - When the unit is not used, turn the power off.
- When the unit is unused for a long period of time, the unit should be unplugged from the household AC outlet.
- No fingers or other objects inside - Touching internal parts of this unit is dangerous and may cause serious damage to the unit. Do not attempt to disassemble the unit.
- Do not put any foreign object on the disc tray.
- Keep away from water and magnets.
- Keep the unit away from flower vases, tubs, sinks, etc. If liquids are spilled into the unit, serious damage could occur.
- Keep magnetic objects, such as speakers, distant from the player.
- Stacking - Place the unit in a horizontal position and do not place anything heavy on it.
- Do not place the unit on amplifiers or other equipment which may become hot.
- Condensation - Moisture may form on the lens in the following cases: a) immediately after a heater has been turned on b) in a steamy or very humid room c) the unit is moved from a cold environment to a warm one.
- If moisture forms inside this unit, it may not operate properly. In this case, turn off the power and wait about one hour for the moisture to evaporate.
- Noise interference while a broadcast is being received - depending on the reception condition of the TV, interference may appear on the TV screen while you are watching a TV broadcast, if the unit is switched on. This is not a malfunction of the unit or the TV. To watch a TV broadcast, turn off this unit.

**SAVE THESE INSTRUCTIONS**

# IMPORTANT BATTERY SAFETY PRECAUTIONS

Read these instructions carefully before using the battery.

## **Charging**

- Charging shall be less than specified 8.4 V.
- The battery should be charged within the specified temperature of 0~45° C.

## **Discharging**

- In order to prevent over-discharging, the battery should discharge between 7.2 to 7.8 V.
- The battery should be discharged within the temperature range of -20~60° C.

## **Storage**

- The battery should be stored within the temperature range of -20~50° C.
- Keep the battery terminals clean while storing.

## **Others**

- Do not disassemble the cells and battery.
- Do not use a damaged battery.
- Do not expose the battery to fire, or throw the battery into a fire. This may cause the battery to explode.
- Use the specified charger only.
- Do not touch the battery terminals with metal objects.
- Keep out of reach of children.
- If any electrolyte contacts with your hands or clothes, wash it off thoroughly with water.
- The battery may present a risk of fire or chemical burns if misused.

## **Notes on Copyright**

This product incorporates copyright protection technology that is protected by method claims of certain U.S. Patents and other intellectual property rights owned by Macrovision Corporation and other rights owners.

Use of this copyright protection technology must be authorized by Macrovision Corporation, and is intended for home and other limited viewing uses only unless otherwise authorized by Macrovision Corporation. Reverse engineering or disassembly is prohibited.

Manufactured under license from Dolby Laboratories. "Dolby", "Pro Logic" and the double-D symbol are trademarks of Dolby Laboratories. Confidential Unpublished Works.

© 1992-1997 Dolby Laboratories, Inc. All rights reserved.

## **Note on Progressive Scan**

Consumers should note that not all high definition television sets are fully compatible with this product and may cause artifacts to be displayed in the picture. In case of 525 or 625 Progressive Scan picture problems, it is recommended that the user switch the connection to the 'Standard Definition' output. If there are questions regarding our TV set compatibility with this model 525p and 625p DVD Player, please contact our customer service center.

# CONTENTS

<b>SAFETY INSTRUCTIONS</b> .....	<b>2</b>	<b>DVD PLAYER OPERATION</b> .....	<b>20</b>
<b>IMPORTANT BATTERY SAFETY PRECAUTIONS</b> .....	<b>3</b>	Using disc menus.....	20
<b>CONTENTS</b> .....	<b>4</b>	Using the return key .....	20
<b>FEATURES</b> .....	<b>5</b>	Basic disc playback .....	20
<b>INTRODUCTION</b>		About the screen-saver .....	20
Features .....	5	Skipping to the next/previous track.....	21
Optical disc compatibility .....	5	Fast forward and fast reverse.....	21
Caring for optical discs .....	5	Advanced playback .....	21
<b>GETTING STARTED</b>		Jumping to a specific chapter/track .....	21
Checking the package contents .....	6	Repeating a disc, chapter or track .....	22
Using the remote control .....	7	Repeating a segment you define .....	22
Installing the remote control battery .....	6	Multi-angle function .....	22
Operating the remote control.....	6	Subtitles .....	22
<b>REMOTE CONTROL FUNCTIONS</b> .....	<b>8</b>	Changing the audio track.....	22
<b>FRONT PANEL FUNCTIONS</b> .....	<b>9</b>	Using the zoom function .....	23
<b>THE FUNCTION MENU</b> .....	<b>10</b>	Using the program function.....	23
Using the function menu .....	10	Using the GOTO function .....	24
Function menu options .....	10	Jumping to a chapter/track .....	24
<b>DVD PLAYER CONNECTIONS</b> .....	<b>11</b>	Saving BOOKMARKS for quick play .....	25
<b>THE INTERNAL BATTERY</b> .....	<b>12</b>	Saving a bookmark .....	25
Accessing the battery.....	12	Playing a bookmark .....	25
Removing the battery.....	12	Clearing a bookmark .....	25
Inserting the battery .....	12	The DISPLAY menu .....	26
Charging the battery .....	13	Overview of the display menu.....	26
<b>CONNECTING THE POWER</b> .....	<b>14</b>	Using the display menu .....	26
Using the car adapter .....	14	<b>MP3 MUSIC AND JPG IMAGES</b> .....	<b>27</b>
Using the headphones .....	14	The MP3/JPG navigator .....	27
Using the power adapter .....	14	Selecting which files to view.....	27
<b>AUDIO / VIDEO CONNECTIONS</b> .....	<b>15</b>	Changing the PLAY mode.....	28
Connecting the video output .....	15	Changing the slideshow interval .....	28
Composite video .....	15	Rotating and flipping JPG images.....	28
S-Video .....	16	Using the ZOOM function with JPGs.....	29
Component video / P-SCAN .....	16	<b>THE DVD PLAYER SETUP MENU</b> .....	<b>30</b>
Audio output connections .....	17	Using the setup menu .....	30
Connecting external A/V sources .....	18	The system page .....	31
Adjusting brightness .....	18	The video page.....	31
<b>GETTING STARTED</b> .....	<b>19</b>	The audio page.....	32
Powering ON and OFF the unit.....	19	The dvd setup page .....	32
Inserting a disc.....	19	<b>TROUBLESHOOTING</b> .....	<b>33</b>
		<b>SPECIFICATIONS</b> .....	<b>34</b>
		<b>INDEX</b> .....	<b>35</b>

## FEATURES

The CH-LDV 700B is a Portable DVD Player with 7" LCD Screen, 2.5 Hour Battery and Progressive Scan Video Output. Not only does it make a great traveling companion, but it functions just like a set-top DVD player with your home entertainment center. This player can handle not only DVDs, but also JPG images from your digital camera and MP3 music files you download. And it reads DVD-R/RW, DVD+R/RW and CD-R/RW discs for maximum compatibility.



- Progressive Scan Video Out for High-End TVs and Projectors
- Plays DVD, SVCD, VCD, Audio CD, MP3, JPG and MPEG formats
- Plays DVD, DVD-R/RW, DVD+R/RW and CD-R/RW discs
- Component Video, S-Video and Composite Video Outputs
- Analog Stereo and Mini-Optical Digital Audio Outputs
- Advanced Playback Functions: Slow Playback, Repeat Playback, Parental Control, MP3/JPG Navigator, JPG Slideshows, Screen Saver, Multi-Level Zoom Function, Track Selection, On-Screen Display, Custom Playlists and many more!

## DISC COMPATIBILITY / CARE

### Optical Disc compatibility

- This unit plays DVDs recorded for a particular region.
- The region mark on the back of the player must correspond to that on any DVD discs you wish to play. Units sold in North America are coded for Region 1, and marked as shown:



- This unit supports CD-R/RW discs recorded with MP3 or JPG files, and in VCD format.
- MP3 files must be named with the extension “.MP3”
- JPG files must be named with the extension “.JPG”
- JPG images must be saved with “standard” encoding, rather than “progressive” encoding.
- Discs created with personal computers may have problems playing due to differences in recording software settings, disc formats and other factors.

### Caring for Optical Discs

- Hold a disc by the rim or with an index finger in the central hole. Never touch the signal surface.
- Finger prints or stains on the surface of the disc may cause signal loss.
- Use a soft cloth and wipe in a radiating manner from the center of the disc to the outer rims when cleaning the disc surface.
- Never add labels or adhesive tapes on the discs and be careful not to scratch or damage the disc surface.
- To prevent discs from becoming bent or deformed, they should be vertically kept in the disc storage case. To prevent damage, avoid leaving discs in your car, where they may be subject to direct sunlight and high temperature.
- Do not use any disc accessory to improve the audio quality, disc protective solutions or lens cleaner. These products may damage the disc surface.

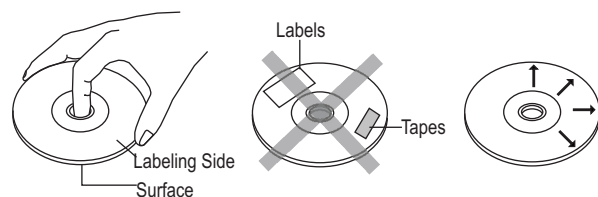

# GETTING STARTED

## Make sure the package contents are complete

In addition to the DVD player, your package should contain the following accessories. Check the contents of the package carefully, as some items may be located under or inside the packing foam.

Remote control

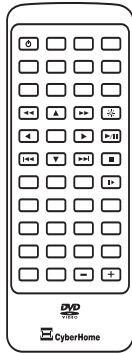

Remote Control Battery



\*The battery may be pre-installed in the remote control. If so, pull out the plastic tab to enable the battery. (See page 7)

This operation manual and warranty card

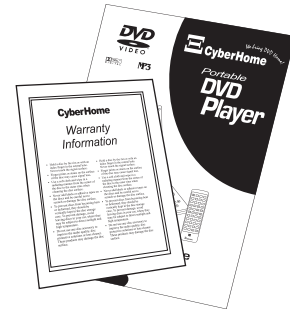

Internal Battery Pack

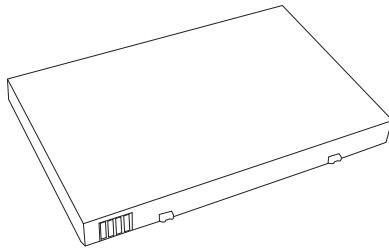

Headphones

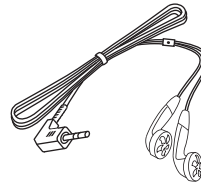

Stereo Audio Cable

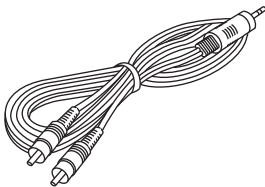

Composite / S - Video Video cable

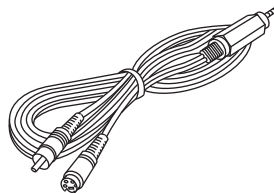

Power cord

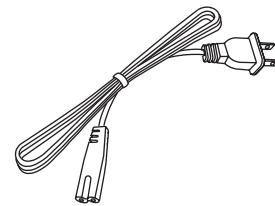

AC Power Adapter

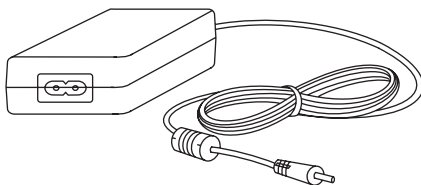

Car Adapter

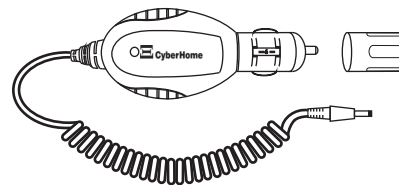

## Using the Remote Control

The DVD player comes complete with a remote control. Simply pull out the plastic tab in the remote control to activate the battery. The plastic tab - which covers the battery terminals - extends the life of the battery. \*Please note that some models will not include this plastic tab. If this is the case, please refer to the next section for battery installation.

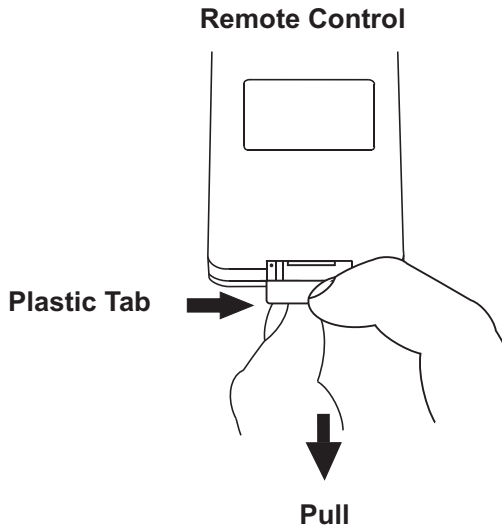

- Place the battery into the holder as pictured below with the **POSITIVE SIDE** (marked on Battery as "+") facing upwards and insert into the remote control to complete the battery installation.

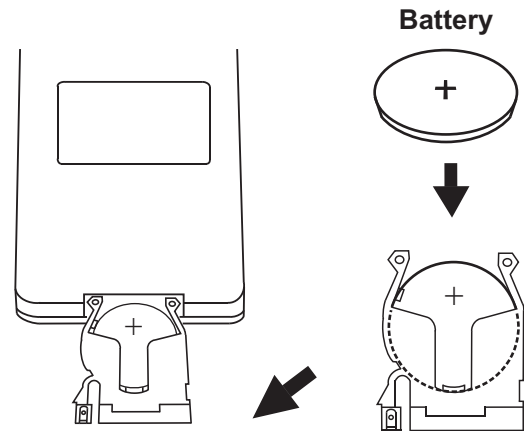

## Operating the Remote Control

When using the remote control, be sure to stay within a 30 degree angle of the sensor on the receiver. Keep in mind that any obstructions between the remote control and the receiver will affect performance.

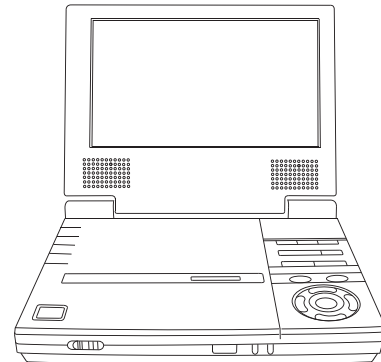

## Replacing the Battery

To replace the remote control's battery, the battery holder must be removed. Be sure to take note of the polarity marking on the battery. The "+" side must face the bottom of the remote (the side without any buttons).

- To access the Battery, remove the Battery Holder from the remote control. To remove the battery holder, use your thumbnail to squeeze the Release Clip in toward the center, while simultaneously pulling the Handle out with your index fingernail, as depicted below:

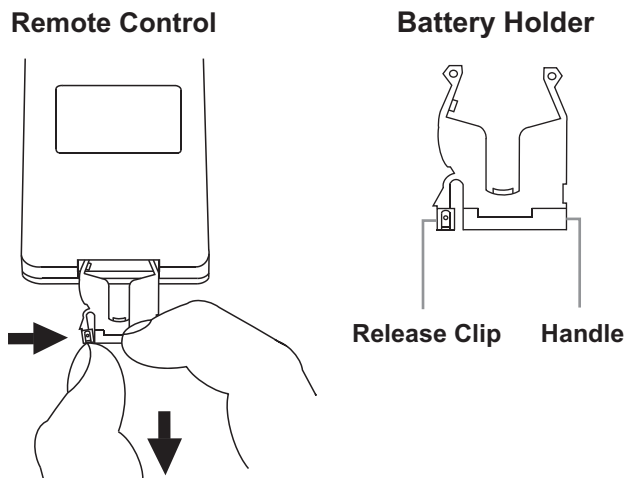

## Notes on battery

- If the remote control functions better when it is closer to the unit, the battery may need to be replaced.
- In case of any leakage of the battery, dispose of the battery right away and avoid touching the chemical discharge. Make sure to clean the remote control's battery compartment before installing a new battery.



# REMOTE CONTROL FUNCTIONS

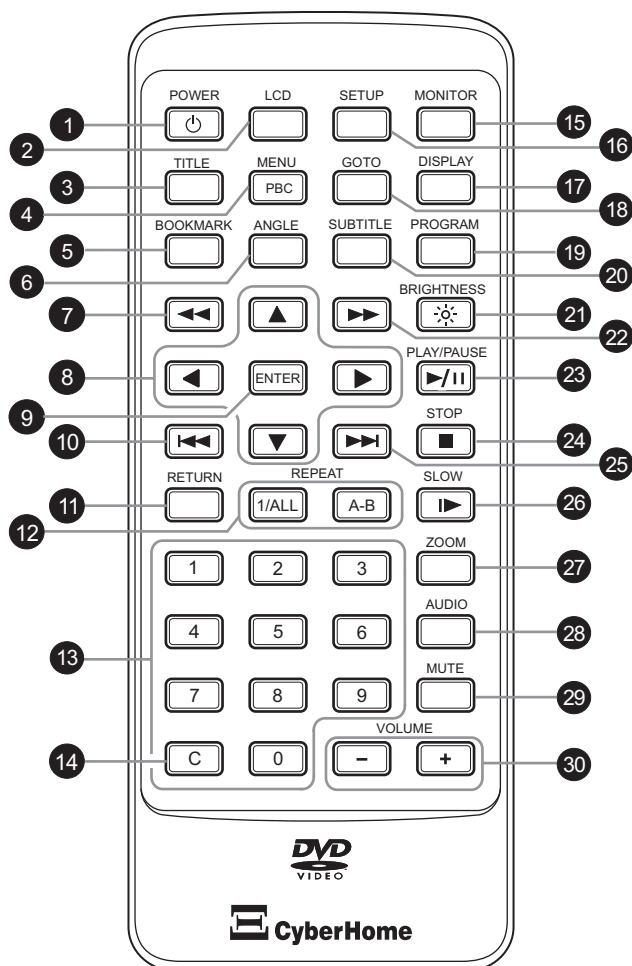

## 1 POWER

Turns the DVD player on or off.

## 2 LCD

Press to cycle through and select the display mode you wish, includes full, wide, normal or off.

## 3 TITLE

Accesses Menus on DVD Discs. With VCD discs, turns the PBC function On/Off.

## 4 MENU / PBC

Accesses the Title menu on DVD Discs.

## 5 BOOKMARK

Press to store the current point on the disc as a bookmark that can be accessed quickly without searching.

## 6 ANGLE

Selects between the multiple angle views on supported DVD's.

## 7 FAST REVERSE

Scan in fast reverse on DVD's and other discs.

## 8 ARROWS

Use to navigate disc menus, on-screen setup menu, etc.

## 9 ENTER

Selects options in menus.

## 10 SKIP PREVIOUS

Press to skip to the previous chapter or track.

## 11 RETURN

Returns to the previous menu accessed in DVD mode.

## 12 REPEAT 1/ALL, A-B

Used with DVD discs, 1/ALL repeats a chapter, title or disc. A-B sets the beginning and ending of a time segment to repeat.

## 13 NUMBER KEYS

Use to enter numeric values when using GOTO and more.

## 14 CLEAR

Clears input when entering values.

## 15 MONITOR

Use to switch between selectable video input / output. Includes regular unit viewing, unit to external monitor and composite input from external device.

## 16 SETUP

Accesses the on-screen Setup Menu for settings adjustment.

## 17 DISPLAY

Shows the elapsed time and other information during playback of a disc.

## 18 GOTO

Press to navigate to a specific chapter. Follow with corresponding number key.

## 19 PROGRAM

Create a custom play list of selected tracks and sequence.

## 20 SUBTITLE

Selects available subtitles on DVD.

## 21 BRIGHTNESS

Use to adjust the brightness level.

## 22 FAST FORWARD

Scan in fast forward on DVD's and other discs.

## 23 PLAY/PAUSE

Use to play a disc, chapter or track.

Press to pause audio track play or video to a still frame. Press again to advance frame by frame ( DVD ) or resume playback ( Audio CD ).

## 24 STOP

Press once to stop current disc play but holds resume location. Press again to completely stop play - also required for some setup functions.

## 25 SKIP NEXT

Press to skip to the next chapter or track.

## 26 SLOW

Press to advance slow.

## 27 ZOOM

Press to magnify and shrink the screen with DVD discs.

## 28 AUDIO

Selects an audio track on DVD or VCD discs.

## 29 MUTE

To turn off sound. Press again to turn sound back on.

## 30 VOLUME

Press the "+" key to increase the volume level and "-" key to decrease.



# FRONT PANEL FUNCTIONS

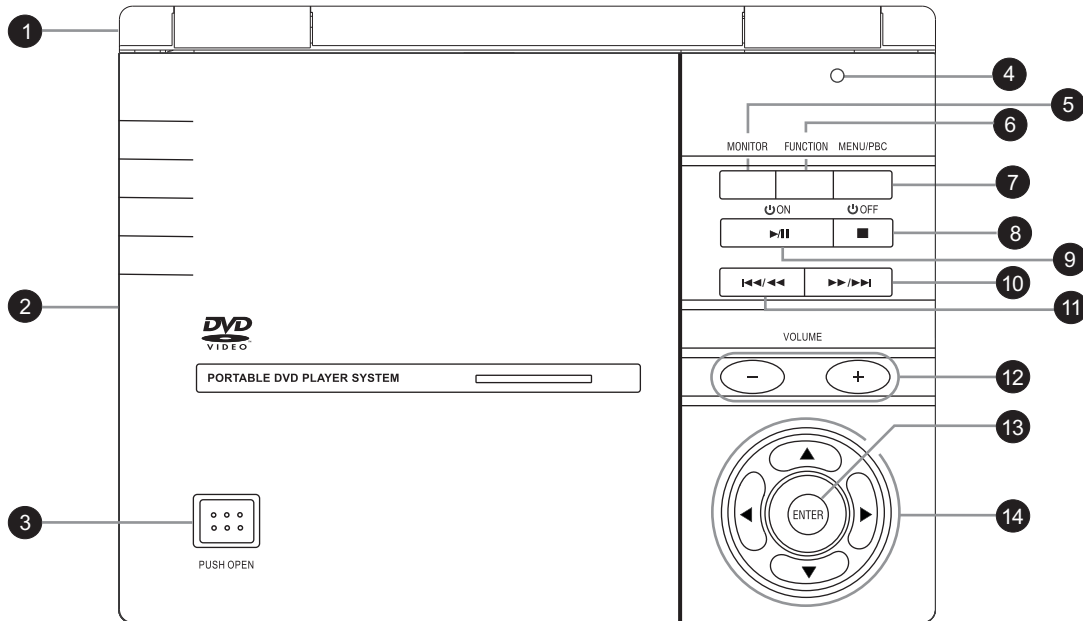

**1 LCD SCREEN**

The DVD Player's LCD Screen.

**2 DISC DOOR**

Open to access the disc tray.

**3 DISC DOOR BUTTON**

Push to open the disc door.

**4 LCD BUTTON**

Closing the LCD screen activates this button to turn off the LCD screen.

**5 MONITOR**

Switches to External Monitor Output or A/V Input mode.

**6 FUNCTION**

Press to enter the Function Menu to control options such as LCD mode and Display.

**7 MENU / PBC**

Accesses the main menu with DVDs. Turns On/Off Playback Control with SVCDs.

**8 OFF**

Use this button to power OFF the unit.

**9 PLAY / PAUSE / ON**

Multifunction button controls the play, pause and power ON function.

**10 NEXT / FAST FORWARD**

Press to begin Fast Forward playback. Press and HOLD to advance to the next chapter/track.

**11 PREVIOUS / FAST REVERSE**

Press to begin scanning in Fast Reverse mode. Press and HOLD to return to the previous chapter/track.

**12 VOLUME**

Use the '+' or '-' buttons to control the volume level during playback.

**13 ENTER**

Use to select options in menus.

**14 ARROW BUTTONS**

Use to navigate disc menus, on-screen setup menu, etc.

## The FUNCTION menu

The purpose of the player's FUNCTION MENU is to allow you to access various functions - including the Player SETUP MENU, Battery Status and LCD Adjustments - all without the need for the remote control.

### Using the FUNCTION menu

- 1 Press the Function Key on the front panel of the unit to access the on-screen Function Menu. The Function menu will automatically disappear from the screen after 10 seconds of inactivity.

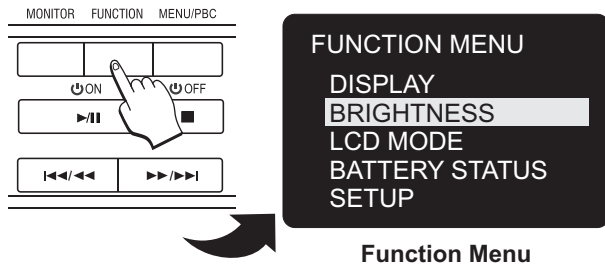

- 2 Use the Arrow Keys on the front panel of the unit or the remote control to navigate the Function Menu. Press the ENTER key to select menu options.

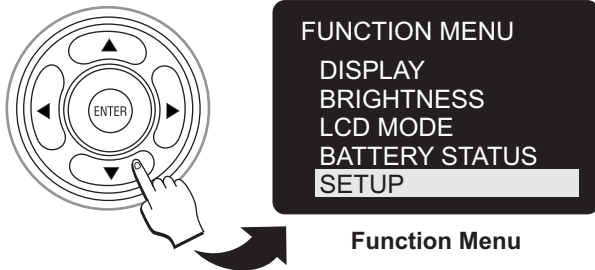

### FUNCTION menu options

#### DISPLAY

Accesses the DISPLAY MENU - See page 26 for complete description.

#### BRIGHTNESS

Adjusts the brightness of the LCD screen. Use the ENTER key to circle through the brightness level.

#### LCD MODE

Change the LCD MODE to match the player's LCD screen to the movie you're watching. For 16:9 or ANAMORPHIC Widescreen movies, the default setting of **16:9 WIDESCREEN** is used.

However, if you're watching a 4:3 "Full Screen" movie, change this setting to **4:3 NORMAL** to simulate the aspect ratio of a normal TV screen. This prevents the movie from appearing stretched horizontally.

### WIDESCREEN Movie with 16:9 LCD Setting

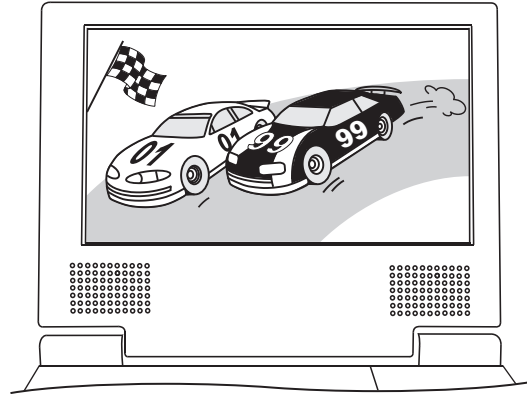

16:9 Widescreen movies fill the entire screen and show more detail than "fullscreen" movies. (ANAMORPHIC 2.35:1 Widescreen movies will show bars on the top and bottom.)



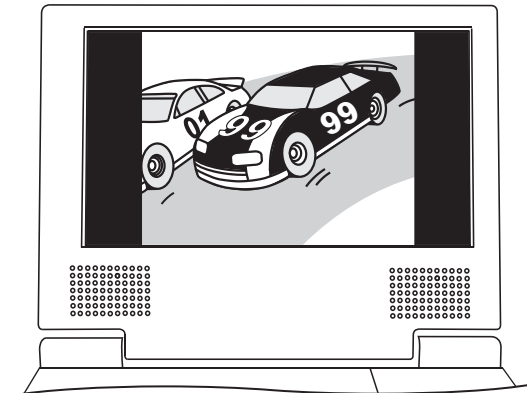



### "FULLSCREEN" Pan/Scan Movie with 4:3 LCD Setting



"FULLSCREEN" movies, which are formatted to fill the FULL-SCREEN of a normal TV, must be viewed with bars on the sides to obtain the correct aspect ratio and avoid a stretched picture. Fullscreen movies show less detail than Widescreen movies.

### BATTERY STATUS

Displays the Battery Charge Status Indicator:

	Running on AC Power Adapter
	Battery Fully Charged
	75% Battery Charge Remaining
	50% Battery Charge Remaining
	Battery Almost Empty
	Battery Needs Charging

### SETUP

Access the player's SETUP MENU. See page 30 for more.

# DVD PLAYER CONNECTIONS

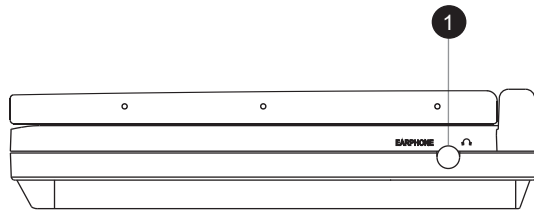

RightSide

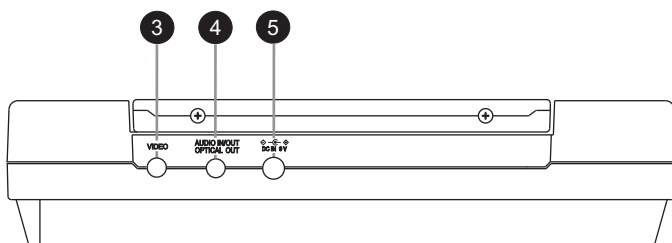
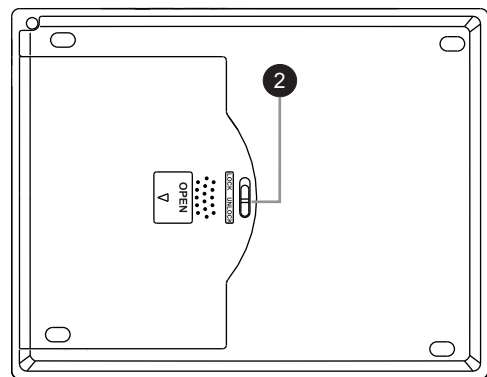

RearPanel

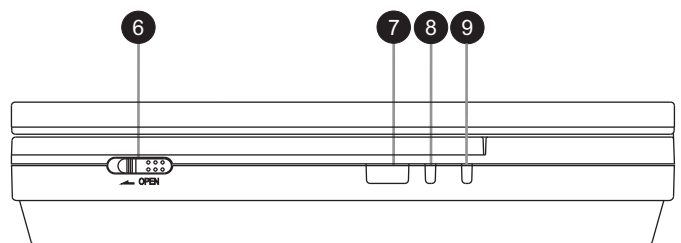

FrontPanel

## 1 HEADPHONE JACK

Connect to the included headphones for a private listening environment.

## 2 BATTERY RELEASE LATCH

Slide latch to UNLOCK to take off battery compartment cover.

## 3 VIDEO IN / OUT

Able to support Component, S-Video or Composite video INPUT / OUTPUT for TVs with matching input. Use the provided video cable or optional Component/P-SCAN cable only for this connection.

## 4 AUDIO IN / OUT - OPTICAL DIGITAL IN / OUT

Use the provided analog stereo INPUT / OUTPUT cable to make a connection between the unit and an audio output device. The most common connection made is to a TV. You can also use a mini - optical cable (not included), to connect to a receiver or other device with a 5.1 channel decoder. This is a coded digital signal.

## 5 POWER CORD SOCKET - DC IN 9V

Main power socket for the unit. Connect to the car adapter or AC power adapter.

## 6 LCD SCREEN RELEASE LATCH

Slide release hatch in the direction of the arrow to release the LCD screen locking mechanism.

## 7 REMOTE CONTROL RECEIVER

The remote control receiver for the unit. Keep the receiver free from obstructions to allow for proper operation.

## 8 BATTERY STATUS LED

Provides the charge status of the internal battery when the unit is off and the battery is being charged. A RED color signals that the battery is in need of recharging and GREEN designates that the battery is fully charged.

## 9 STATUS LED

The Status LED indicates the current MONITOR mode, glowing GREEN to indicate Internal LCD mode or External Monitor mode, and ORANGE to indicate A/V Input mode.

# THE INTERNAL BATTERY

## Accessing the Battery

Your portable DVD player features an internal battery pack. To access the battery compartment for insertion or removal of the battery, follow these steps.

### Removing the Battery

- 1 Turn the DVD player upside down as shown below. Slide the battery latch to UNLOCK. Press down on the DOTS to unlock the battery compartment cover while sliding the cover off.

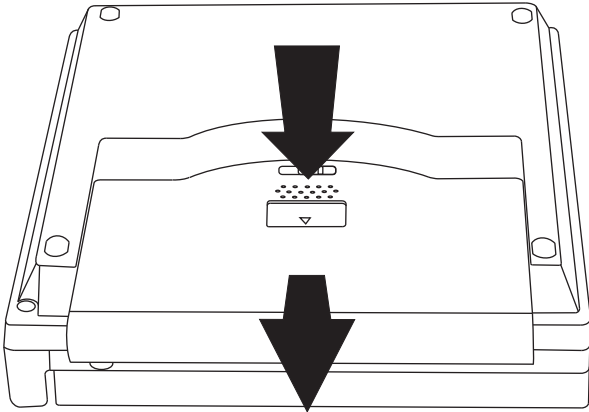

- 2 To remove the battery, gently lift up the end closest to the edge of the unit as shown below. Then pull the battery out.

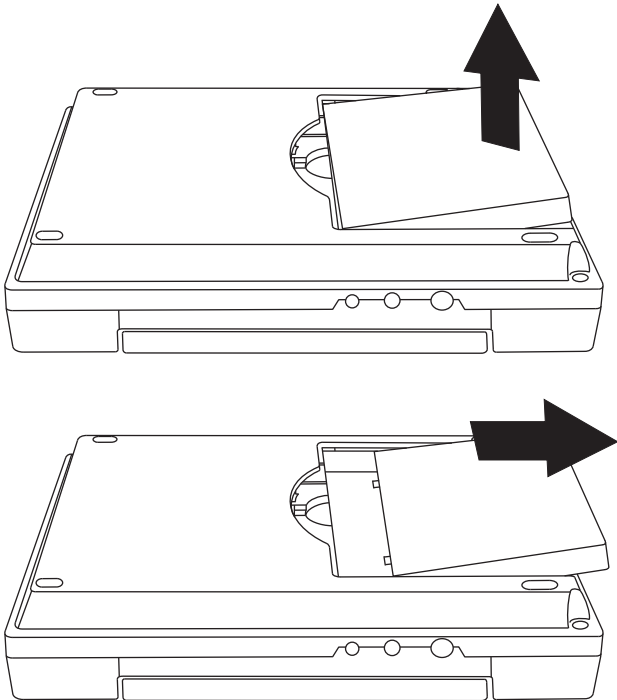

### Inserting the Battery

- 1 Insert the battery as shown below, first by placing the battery into the compartment, aligned as shown below with the top facing up. Next, gently slide the battery in until it lays flush with the bottom of the unit.

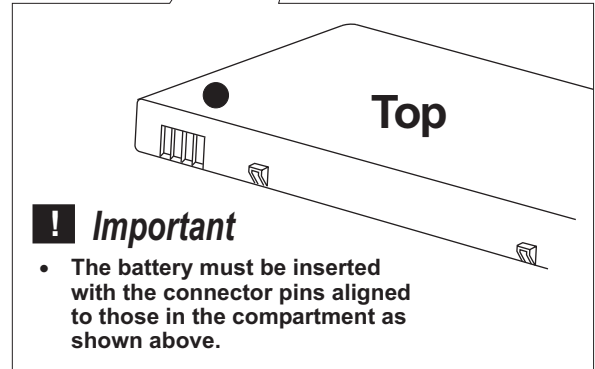
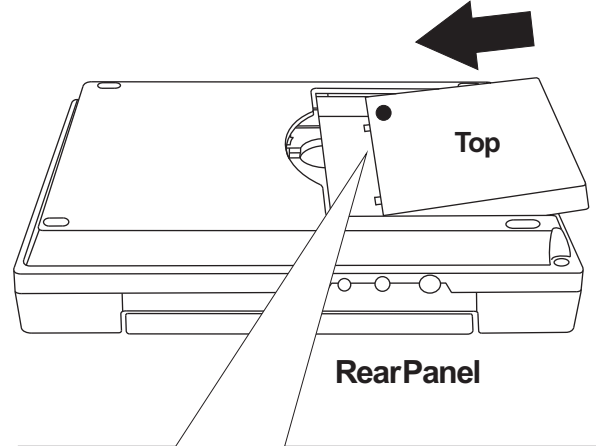

### ! Important

- The battery must be inserted with the connector pins aligned to those in the compartment as shown above.

- 2 Re-install the battery compartment cover by laying it flat with about a 1/2" space between the button and the bottom of the player as shown below. Next, slide the compartment cover closed until it snaps into place, and then slide the battery latch to LOCK.

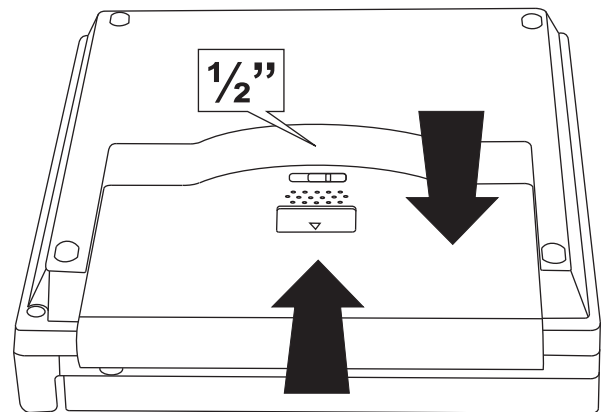

## Charging the Battery

The battery must be charged before first use. Use the included AC Adapter to charge the battery.

- 1 Connect the AC adapter to the DC IN 9V connector on the unit as shown below. Connect the other end into a standard electrical wall jack.

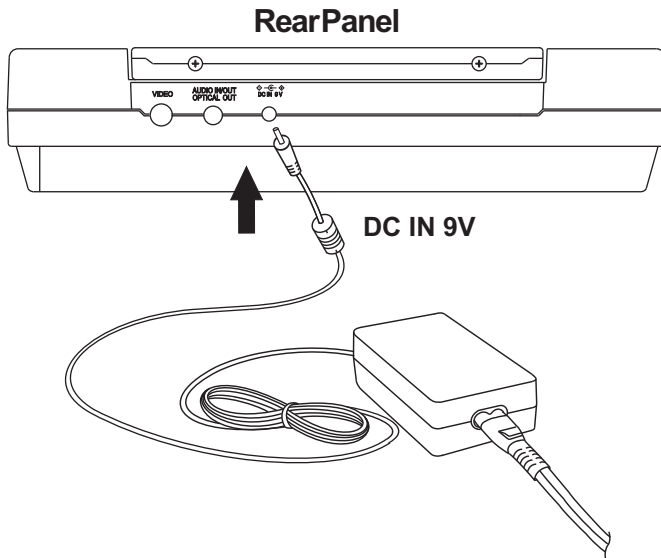

- 2 The BATTERY STATUS LED will glow red indicating that charging is needed. When the BATTERY STATUS LED turns green, the charging cycle has been completed.

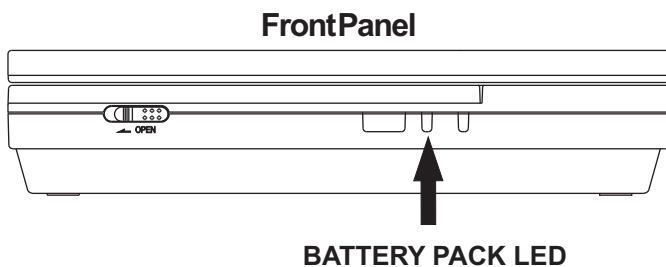

### ! Important

- Recharge your battery pack only when the battery status is less than 25%. Unnecessary charging will reduce the battery pack service lifetime.
- When the battery pack is being charged, the LED will glow RED. After successfully charging the battery pack, the LED will glow GREEN.
- The time to charge the battery pack is normally 3.5 to 4.5 hours. Do not charge for more than 8 hours.
- The battery may only be charged when the unit is OFF.

# CONNECTING THE POWER

## Using the Car Adapter

The DVD player comes complete with a car adapter so you can enjoy entertainment on the road.

- 1 To use the car adapter in your vehicle, simply plug it into your car's power receptacle as depicted below. Plug the smaller end into the unit's 'DC IN 9V' power connector.

### ! Important

- Do not operate the unit or view the video output while operating a motor vehicle.
- Place the unit in a secure position before operating the vehicle.
- Do not use the car adapter to charge the battery pack. The car adapter can only be used during playback of discs.

## Using the Headphones

The DVD player comes complete with headphones to use when you prefer a private listening environment.

- 1 Insert the headphones into the jack on the right side of the unit. Adjust the volume level with the volume "+" or "-" keys on the remote control or front panel to a low output level. Place the earphone buds into your ears. Lastly, gradually increase the volume to a comfortable listening level.

### ! Important

- Extended use of headphones at excessively loud volume levels could cause damage to your hearing.
- Turn down the volume before connecting to the unit, then raise the volume to your comfort level.
- No sound will come out from the unit's speakers once the headphones are connected.

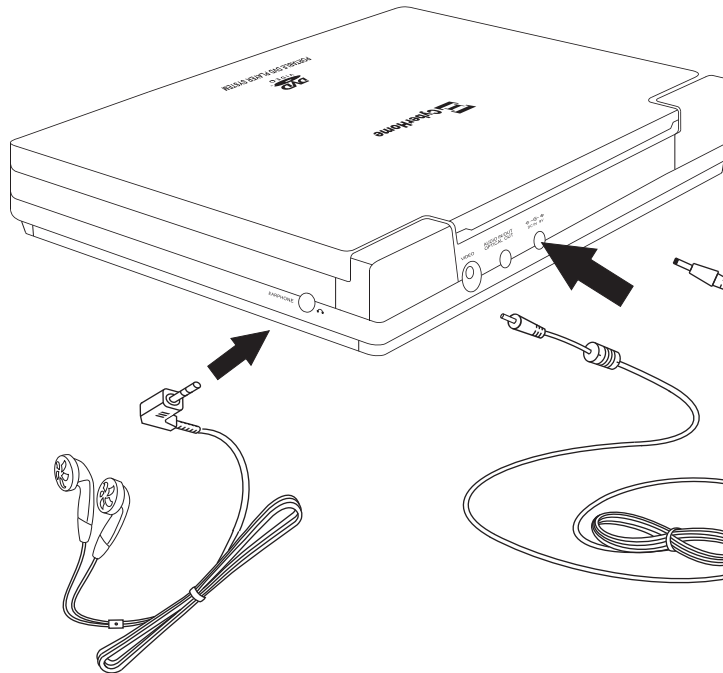

## Using the AC Power Adapter

The DVD player comes complete with a power adapter to charge the battery pack or to power the unit when attached to an AC wall outlet.

- 1 To use the power adapter, simply connect the appropriate end into an electrical wall outlet as depicted below and the other end into the unit's 'DC IN 9V' connector.

### ! Important

- Once power is applied, with the POWER button set to ON, the unit will be in STANDBY Mode.
- Unplug the adapter from the AC outlet if the unit won't be used for a long time.
- Remove the battery pack when using the AC adapter.

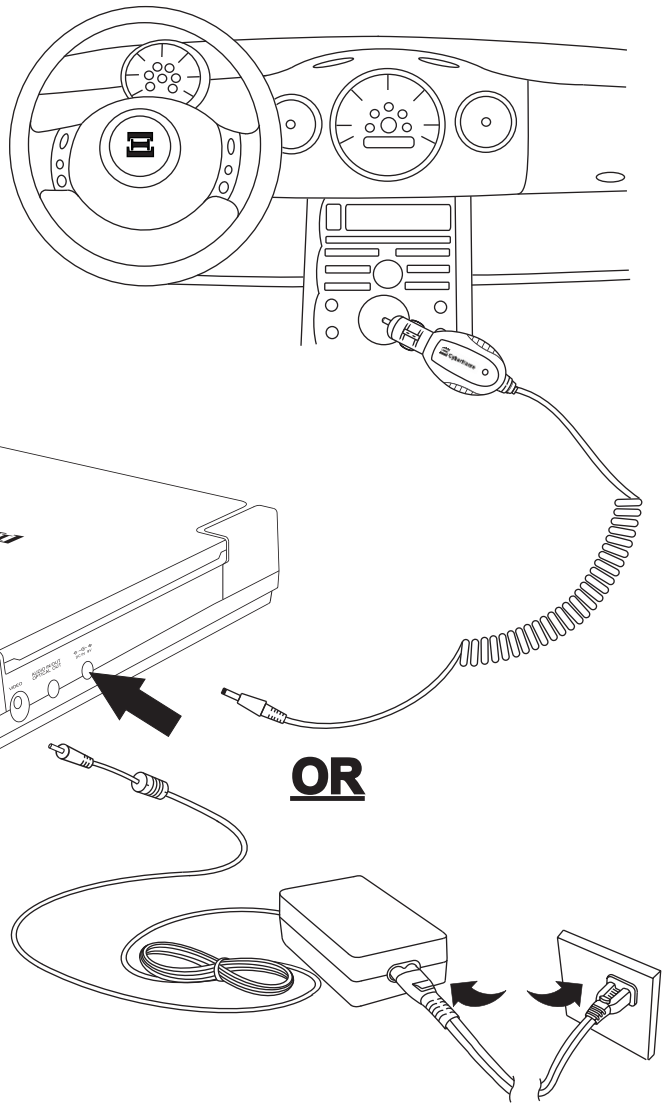



# AUDIO / VIDEO CONNECTIONS

## Connecting the Video Output to your TV

In order to use this DVD player with your TV, a few cable connections are necessary. The capabilities of your TV will determine the connections you can use. There are 3 possible connection types:

- **Composite Video** - The most widely used connection.
- **S-Video** - A higher quality connection that requires the provided S-Video connector and an S-Video capable TV.
- **Component Video** - The highest quality video connection. Supported on high-end TVs (Required for Progressive Scan).

### Composite Video (Typical connection)

Use the Composite/S - Video cable and Stereo Audio cable for connection to TVs with a standard video input as shown below. This is the most widely used type of connection on TV's. The composite connector on your TV is normally colored yellow, and is normally accompanied by stereo audio inputs, colored red and white for stereo channels right and left, respectively.

- 1** First, use the supplied Composite / S - Video cable to connect to the composite video input on your TV. This should be a yellow connector like that shown below.

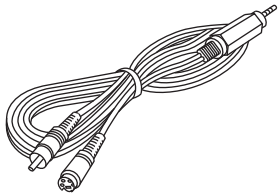

Composite / S - Video Cable



Composite Video Input Jack

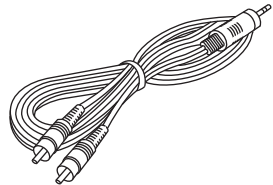

Analog Stereo Audio Cable



Stereo Audio Input Jacks

- 2** If you wish to hear sound through the TV, connect the included red and white analog stereo cable to the audio inputs on the TV.

- 3** On your TV, select the video input. This is normally done by selecting "Video 1" or "Video Input" with the TV's remote control. On some TVs, this is done by selecting a particular channel.

- 4** Press the "Monitor" key on the front panel of the DVD player one time to change the video output mode.

- 5** You should now see the splash screen of the portable DVD player on your TV.

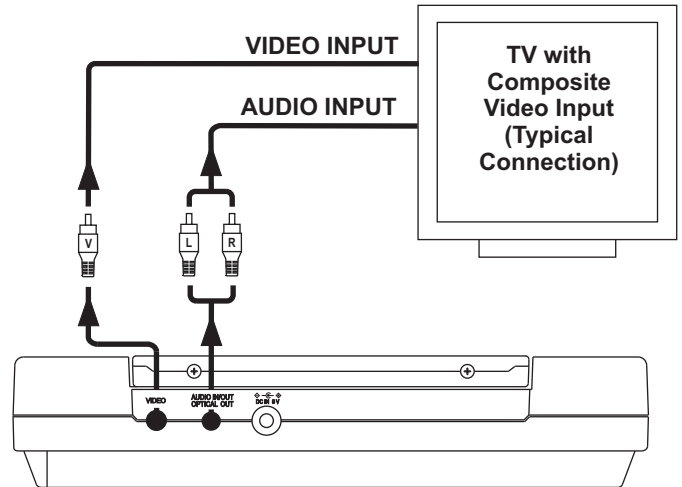

RearPanel

### ! Important note for older TV models

If your TV does not have a composite video-in jack like that pictured above, you cannot connect this unit directly. If this is the case, check to make sure your TV has at least a coaxial connector (used for antenna/cable TV/VCR/etc.) such as that pictured to the right. If this is the case, you can use an *RF Modulator* to convert this unit's video out to the coaxial connection on your TV. RF Modulators are available at major electronics retailers.



Antenna/cable TV coaxial connector on older TVs

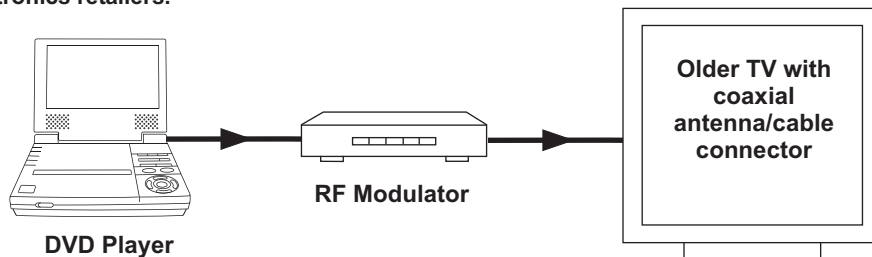

## S-Video

This is a higher quality connection than standard composite video. The S-Video connector is distinguishable by its 4 pins, as shown below. If your TV has an S-Video input, it's recommended that you use this type of connection for better picture quality.

- 1 Connect the Composite / S-Video cable to the unit's Video Out and the black S-Video connector to the corresponding input on your TV.

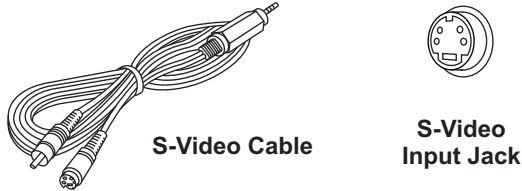

- 2 On your TV, select the S-Video input. This is normally done by selecting "Video 2" or "AV2" with the TV's remote control. On some TVs, this is done by selecting a particular channel.

- 3 Press the MONITOR key on the front panel of the DVD player once to change the video output selection.

- 4 You should now see the DVD player's splash screen on your TV.

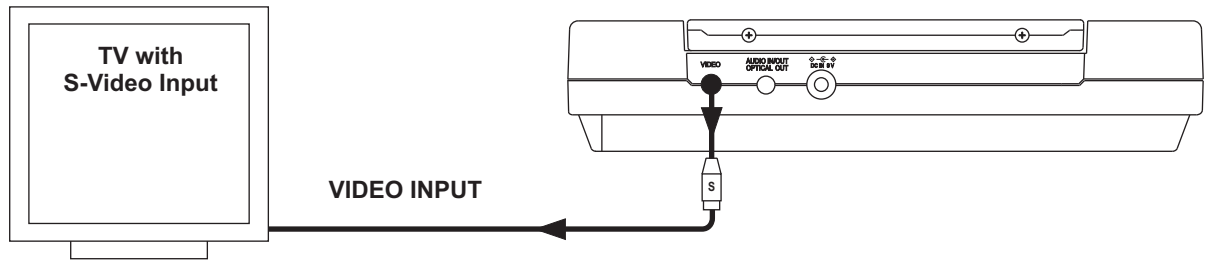

## Component Video / Progressive Scan

The highest quality video connection, Component Video requires the optional **Component/P-SCAN Video Cable** (not included), with separate connectors for the Y, Pb/Cb, and Pr/Cr signals. This cable also supports the Progressive Scan mode when used with high-end P-SCAN TVs. Using the component video output or P-SCAN mode requires these steps:

- 1 Enter the Setup Menu (Page 30) by pressing SETUP on the remote control or by using the FUNCTION key on the player (Page 10). Change the VIDEO OUTPUT setting to YCbCr and exit the SETUP MENU.

- 2 Connect the player to your TV using the Component Video cable. Turn on the TV and select the appropriate input for Component Video IN.

- 3 Press the MONITOR key to switch to External Video. You should now see the player's Splash Screen on the TV.

- 4 **TO SWITCH TO PROGRESSIVE SCAN MODE** - Enter SETUP again and change the SCAN MODE setting to PROGRESSIVE. **WARNING: Do not change this setting unless you're sure your TV supports Progressive Scan.**

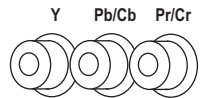

Component Video Input Jacks

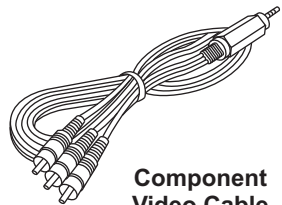

Component Video Cable (not included)

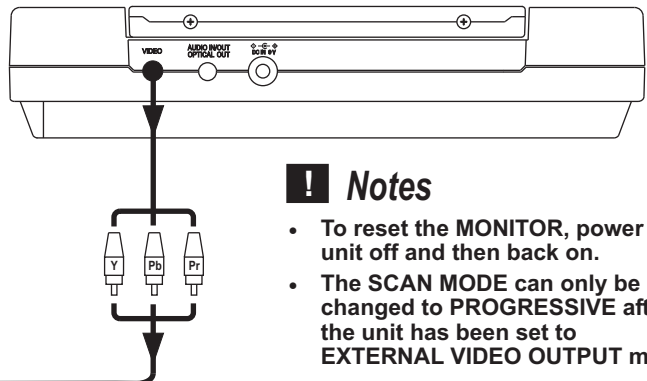
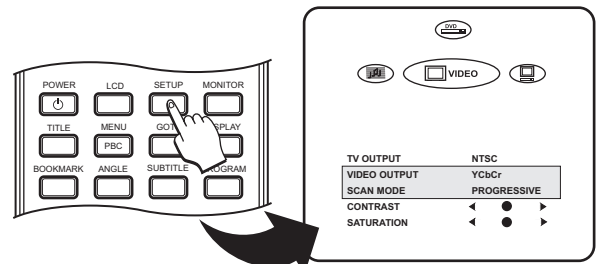

### ! Notes

- To reset the MONITOR, power the unit off and then back on.
- The SCAN MODE can only be changed to PROGRESSIVE after the unit has been set to EXTERNAL VIDEO OUTPUT mode.

## Audio Output Connections

The DVD player features a variety of audio line outputs for connection to a TV or receiver.

- Use the included Stereo Audio cable to connect the stereo analog audio outputs for connection to a TV or recording equipment.
- Or you can use the digital optical audio output to send an encoded digital bit stream to a receiver, suitable for receivers with Dolby Digital decoding capability. This output requires a special mini optical digital cable, \*not included.

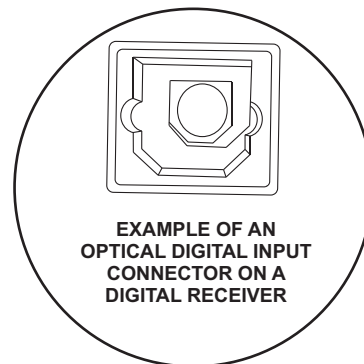
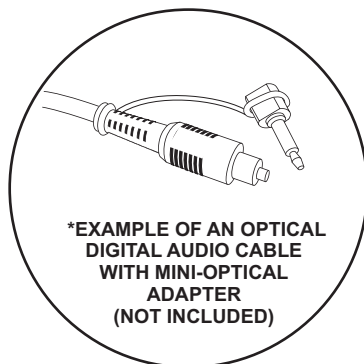
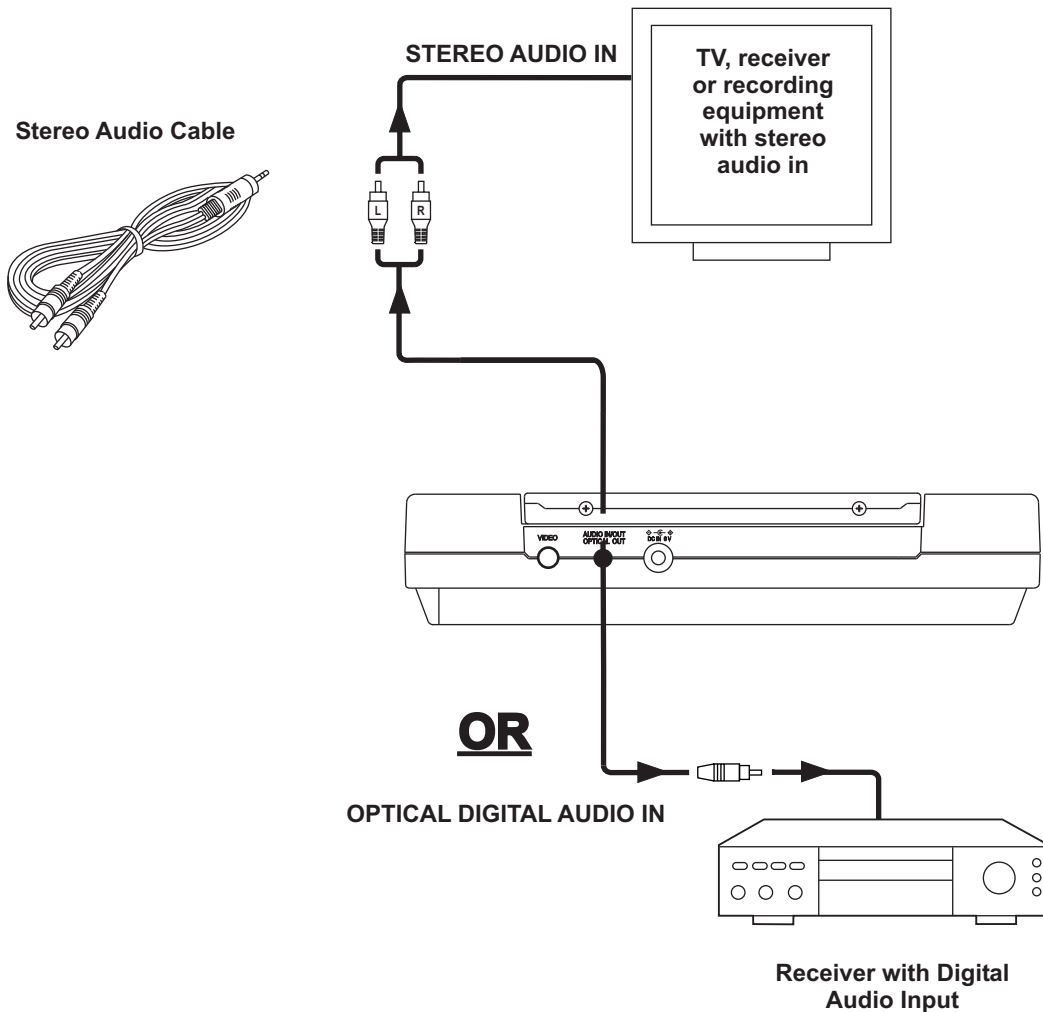

## Connecting an Audio/Video Input Source

Your DVD player can accept an A/V input from an external source, such as a camcorder, VCR or DVD player. In this mode, the player functions as a monitor for the input device.

- 1 Use the included Video Cable to connect the Video Output of your output device (Camcorder, etc) to the unit's Video (Input) connector.

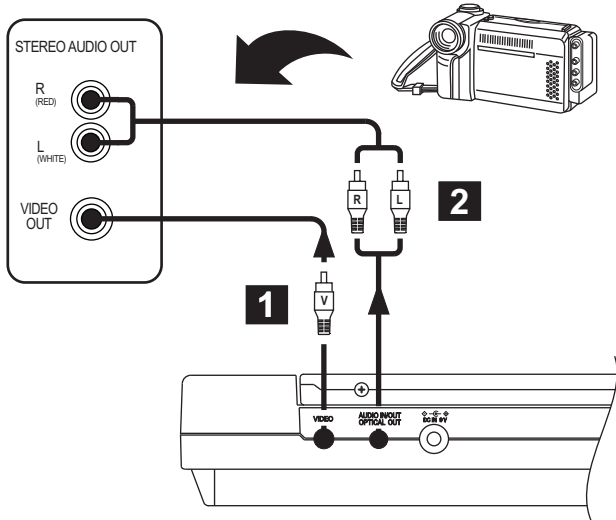

- 2 Next, connect the stereo analog audio outputs of the external device to the audio input plug of the player.
- 3 Turn on the output device, then the DVD player and select the appropriate output on your device.
- 4 Press the MONITOR key on the front panel / remote control two times. The LED indicator will now glow ORANGE to indicate it is now ready to accept an external device input.

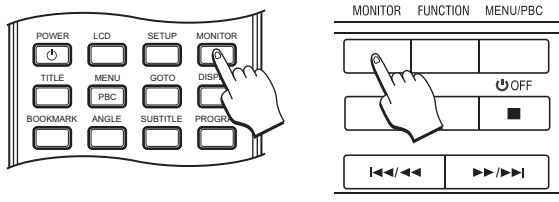

FRONT PANEL

### The MODE LED

The MONITOR LED on the front panel indicates the mode:

- GREEN - Video/Audio Output mode or Normal mode.
- ORANGE - Video/Audio Input mode.

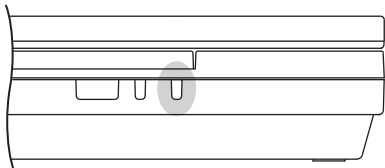

## Changing the LCD Mode

You can change the built-in LCD to match the aspect ratio of the movie you're watching or the video input from an external source. Also, when listening to music from an external A/V source or from an Audio CD or MP3s in the player, you can turn off the built-in LCD display to save battery power.

- 1 Press the LCD key repeatedly or use the FUNCTION MENU (see page 10) to choose an option. Use 4:3 Normal for "FULLSCREEN" movies. Use 16:9 for "WIDESCREEN" movies.

You can turn the LCD OFF to save battery power when listening to music by pressing the LCD button THREE TIMES. If the remote is not handy, simply close the unit to turn off the LCD display.

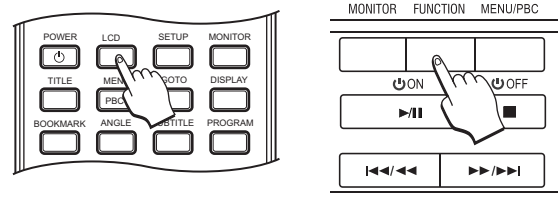

Press the LCD key to bring back the display after it is turned off.

## Adjusting brightness

You can adjust the brightness level of the LCD display quickly and easily.

- 1 Press the BRIGHTNESS key on the remote control to enter the on-screen Brightness menu.

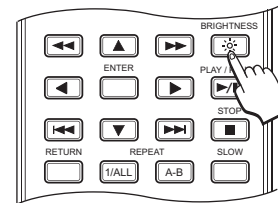

OR

If the remote control is not handy, press the FUNCTION button on the front panel of the player to bring up the FUNCTION MENU, see page 10.



FUNCTION MENU

Press the ENTER on the front panel or BRIGHTNESS on the remote control repeatedly to adjust the brightness level on the LCD screen.



# GETTING STARTED

## Powering On and Off the unit

Connect the power cord only when all other connections are complete.

- 1 To power on the unit, press the **POWER** key on the remote control or the **ON** key on the front panel of the unit. The unit is now ready to use.

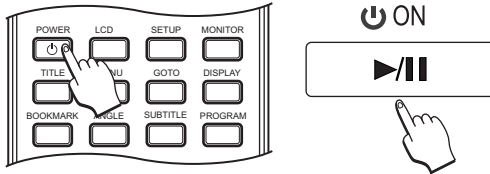

- 2 To power off the unit, press the **POWER** key on the remote control or the **OFF** key on the front panel of the unit. The unit is now in Standby Mode and will use a small amount of power to receive signals from the remote control.

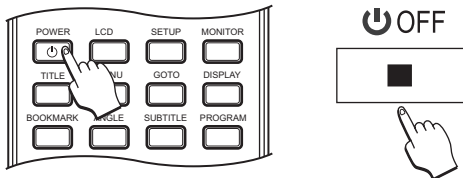

## Notes on Power States

There are 3 power states for this unit:

- **OFF** - The unit is unplugged with the battery removed. The unit draws no power and cannot be turned on by the remote control.
- **STANDBY** - The unit is plugged in to the AC adapter or has the internal battery installed and is turned OFF. The unit can be taken out of standby by pressing either the **POWER** key on the remote control or the **ON** button on the front panel. The unit draws a slight amount of power to enable the remote control receiving circuit.
- **ON** - The unit is plugged in or on battery power and either the **POWER** button on the remote control *or* the **ON** button on the front panel has been pressed. The unit is ready to use.

## Inserting a Disc

- 1 Press the **PUSH OPEN** button on the front panel to open the disc door.

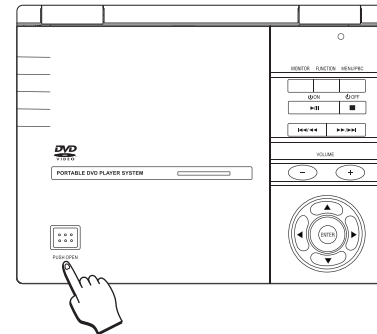

- 2 Insert the disc, being careful not to touch the playing surface. Hold the disc by the sides and with your fore finger through the hold in the middle and insert gently into the tray.

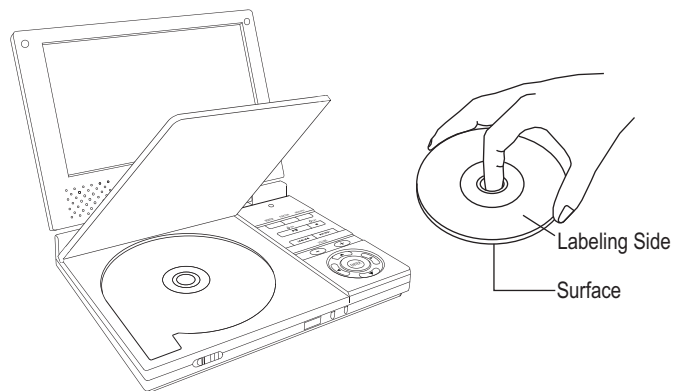

- 3 Close the disc tray door and the unit will automatically start playback of the disc.

# DVD PLAYER OPERATION

## Using Disc Menus

### Playing a disc from the "root" menu

Most DVDs will automatically display a menu after the disc is inserted. This first menu is the first of possibly many layers, and is therefore known as the "root" menu.

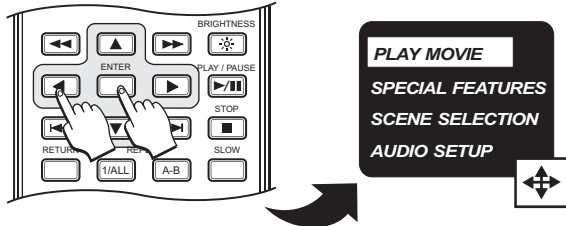

- 1 Use the **ARROW** keys on the remote control to navigate through the menu to the appropriate selection to start the movie.
- 2 Press **ENTER** to confirm your selection.

### Accessing a menu after play has started

- 1 If you wish to re-enter the menu after disc play has started, use the **MENU** key. **MENU** also exits the menu at any time.  
With **VCD** discs, this button functions as **PBC** (Playback Control), enabling or disabling the PBC function.

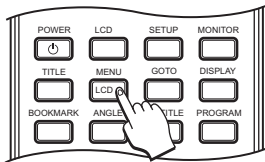

### Using the RETURN Key

- 1 Use the **RETURN** key to exit or return to the menu.

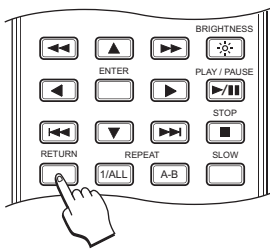

## Basic Disc Playback

### Starting, pausing and stopping disc play

- 1 **PLAY/PAUSE** - The **PLAY** and **PAUSE** functions share the same key. To begin playback of a disc, press the **PLAY/PAUSE** key. To **PAUSE** playback on a single frame, press the key again. To resume normal playback, press again, and so on.

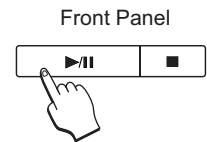
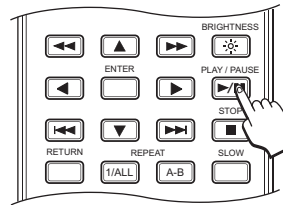

- 2 **STOP** - To stop playback of a disc, press **STOP**. The first time **STOP** is pressed the location where disc play was halted is saved, and you can begin playback where you left off by pressing **PLAY**. If **STOP** is pressed twice, the playback location is reset to the beginning of the disc.

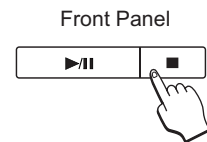
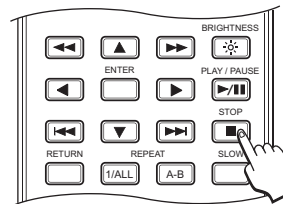

### About the Screen Saver

You can enable the Screen Saver in the player's **SETUP** **MENU**. When enabled, and disc playback remains paused for a period of about 3 minutes, the screen saver will load, protecting the television from "screen burn", which could occur if an unusually bright image is displayed on-screen for an extended period of time.





## Skipping to the next or previous chapter / track

You can advance or skip back through the chapters or tracks on DVD discs, Audio CDs and other discs with the NEXT and PREVIOUS buttons on the remote control or front panel.

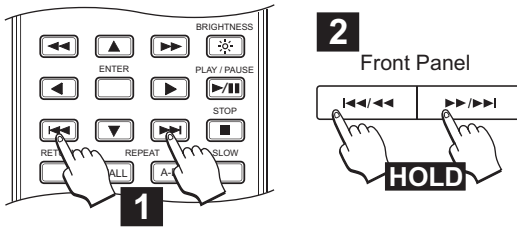

**1** REMOTE CONTROL - Press the NEXT / PREVIOUS keys to jump to the next or previous track on DVDs, Audio CDs and other disc types.

**2** FRONT PANEL - On the front panel, note that the FF and NEXT functions share the same button, and likewise for the FR and PREVIOUS functions. To jump to the next or previous track, press and HOLD the appropriate key for 2 SECONDS.

## Fast Forward and Fast Reverse

You can scan through DVDs, VCDs and other discs in forward or reverse direction at speeds up to 32X (thirty-two times normal speed). Fast forward/reverse scanning will only work *during* disc playback, not when disc play is stopped.

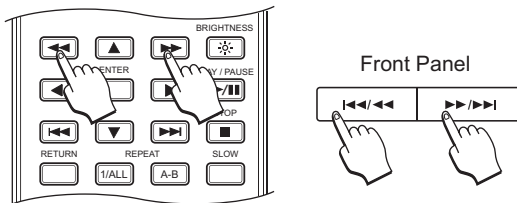

**1** To use the fast forward/reverse function with the remote control or front panel, press the FF or FR key repeatedly to cycle through all speeds in the desired direction. Available speeds are 2X, 4X, 8X, 16X & 32X. To resume normal playback, press the PLAY key.

## Advanced playback

### Slow Motion Playback

This unit supports slow motion playback of up to 1/32 normal speed.

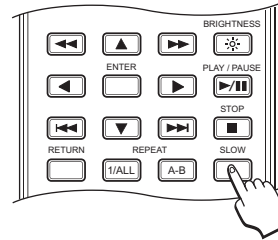

**1** During disc play, press the SLOW MOTION button repeatedly to step through all options for slow playback. With DVDs, you can choose from 1/2, 1/4, 1/8, 1/16 or 1/32 speeds.

### Jumping to a specific Chapter or Track

You can jump directly to any title on DVD discs, or any track on Music CDs with the NUMBER keys.

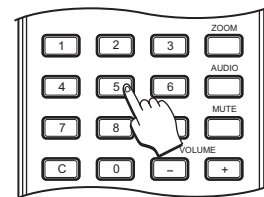

**1** With DVDs, VCDs, or Audio CDs, press a number during playback of a disc to go directly to the corresponding title or chapter. On DVDs, if playback is stopped, pressing a number will jump to a title.

### Notes

- Using the NUMBER keys with VCD discs may require the PBC function to be disabled. To disable PBC, press the PBC button.
- Direct chapter selection may not be supported on some DVD discs.

## Repeating a Disc, Chapter, Title or Track

To repeat a segment of a disc, use the REPEAT 1/ALL key. On DVDs, you can repeat a title or chapter. On VCDs, track and disc repeat is supported, but PBC must be disabled first (Press the PBC key). Audio CDs also allow repeat of tracks, the entire disc or random track playback.

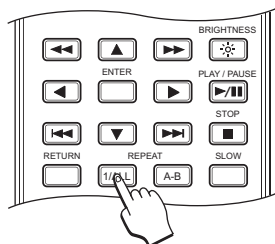

- 1 Press REPEAT 1/ALL during disc playback to cycle through the available options, which are listed on-screen. To cancel repeat mode, press REPEAT again.

## Repeating a Segment you define

Unlike the REPEAT 1/ALL key, which allows you to repeat segments already defined on a disc such as tracks or chapters, the REPEAT A-B key lets you define your own time segments to repeat.

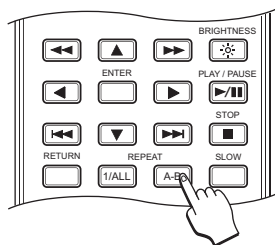

- 1 During playback, when you reach the start of the segment you want to repeat, press the REPEAT A-B button. The following icon is displayed on-screen, letting you know that the beginning segment start point has been saved.



**A - B REPEAT, SET A POINT**

- 2 When you reach the end of the segment you want to repeat, press the REPEAT A-B button again. The repeat icon on-screen changes briefly to the following, reporting that the endpoint of the video segment has been saved. The segment will now begin repeating.



**A - B REPEAT, SET B POINT**

- 3 To cancel repeat and resume normal playback, press REPEAT A-B again. The NORMAL PLAY icon appears briefly on the screen.



**REPEAT OFF**

## Multi-Angle Function

Some DVD discs are recorded with multiple viewing angles for certain scenes. When you are viewing a disc that supports this feature, you can choose among the available angles on the disc with the ANGLE key.

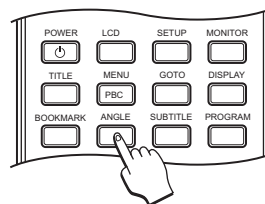

- 1 Most discs with multi-angles will display an indicator, or *Angle Mark*, that alerts the viewer that multiple angles are available for the current scene. When this mark appears on-screen, press the ANGLE button to select an angle to view.

## Subtitles

Most DVD discs include at least one subtitle track in one language. Subtitles are useful viewing movies in a foreign language or for hearing-impaired viewers.

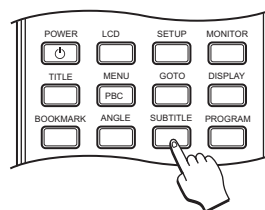

- 1 Press SUBTITLE during playback repeatedly to view all the available subtitles on a disc or turn subtitles off.

## Changing the Audio Track

Most DVD discs are recorded with multiple audio tracks. These can contain multiple languages and different audio formats, such as 2 Channel Stereo or Dolby Digital. A director's commentary track, where the director can be heard discussing the movie, is a common example of an extra audio track on

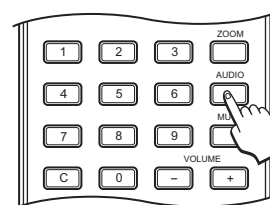

- 1 During playback, press the AUDIO button to cycle through all the available tracks on a DVD or VCD disc.

## Using the ZOOM function

Use the ZOOM function to zoom in or out during disc playback or when a frame is paused on-screen.

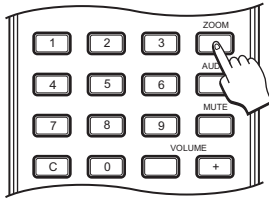

- 1 Press the ZOOM key to magnify the screen by a factor of 2. This is called 2X zoom, and is indicated in the upper left corner of the screen as shown:

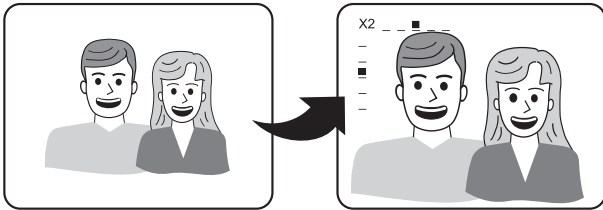

- 2 Press the ZOOM key repeatedly to cycle through all the zoom levels. You can enlarge the screen to 2X or 4X normal size. To resume normal viewing, press ZOOM until the zoom indicator disappears.

- 3 Use the ARROW keys to move around the image. This will display the parts of the image that do not appear on-screen when the image is zoomed in.

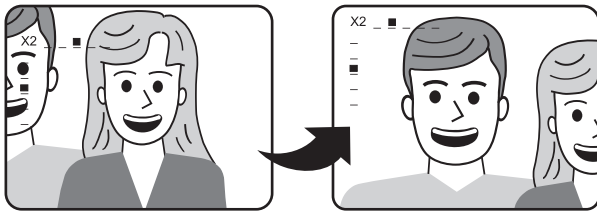
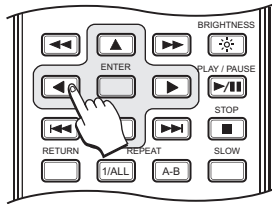

- 4 To EXIT ZOOM mode, continue pressing ZOOM until the picture returns to normal size.

## Using the PROGRAM function

You can create custom playlists with the PROGRAM function, specifying only those chapters/tracks you wish to include and the order in which they'll be played back.

- 1 Press PROGRAM to bring up the Program Menu. There are 10 locations on each page, with a total of 3 pages available. \*Additional pages are displayed after all locations on a page are filled.

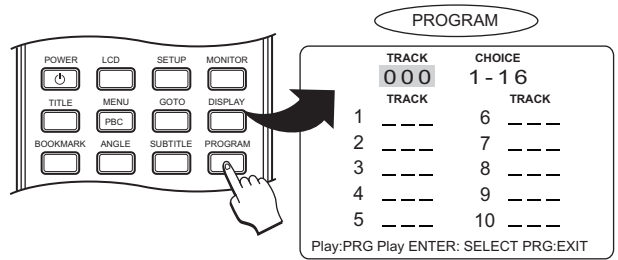

- 2 To add tracks to the playlist, use the NUMBER keys to enter a track number listed under CHOICE, then press ENTER. The track now appears in the first available location. In this example, track 5 will be the first track to playback.

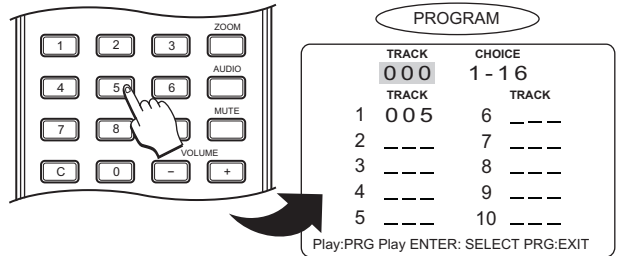

You can clear tracks from any location in the playlist by using the UP / DOWN ARROW keys to move to the location and pressing C.

- 3 To begin playback of your custom playlist, use the ARROW keys to select a starting track and press PLAY. In the example below, we are beginning playback with track 10 at the second position.

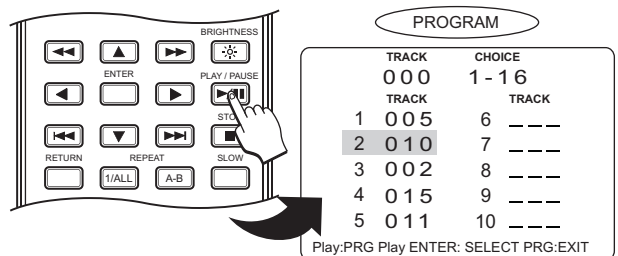

### Notes

- This example shows the PROGRAM function when used with a CD-Audio disc. When used with a DVD disc, additional fields for TITLE will be present.

- 4** The display indicates PROGRAM PLAY has started.



- 5** To exit PROGRAM PLAY, press the STOP key.

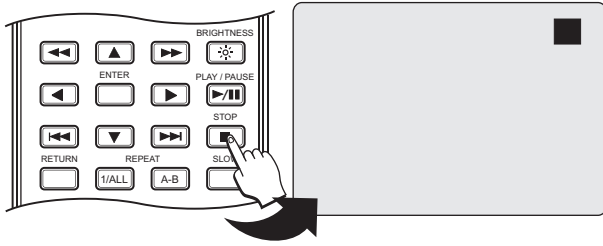

### Using the GOTO function

You can use the GOTO function to jump to a specific time point on a disc, or to go to a particular chapter or track.

### Jumping to a Specific Time on a disc

- 1** During playback of a DVD, press the GOTO key once. A menu item will appear on-screen for you to enter the time (hours, minutes and seconds) on the disc you wish to begin playback.

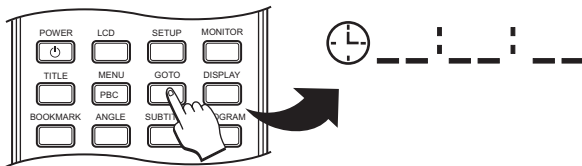

- 2** Use the NUMBER keys to enter the time. In this example, we are jumping to a time on the disc of 32 minutes and 18 seconds, so we enter 0 - 0 - 3 - 2 - 1 - 8. To jump to this time mark, press ENTER.

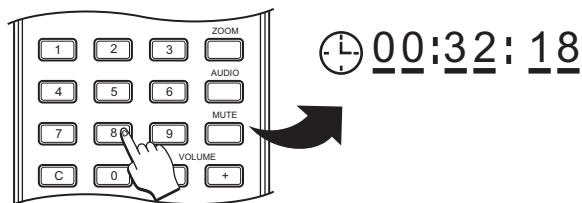

### Jumping to a Specific Chapter or Track

- 1** To go directly to any title, chapter or track on a disc, press the GOTO key TWICE. The on-screen display will indicate the current track, as well as the total number of titles and chapters/tracks.

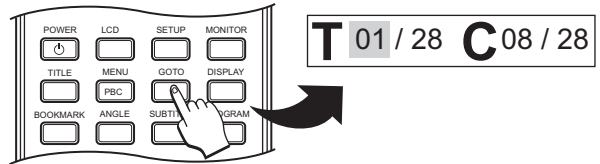

- 2** Press the RIGHT ARROW key to move to the CHAPTER field, which shows the chapter currently playing.

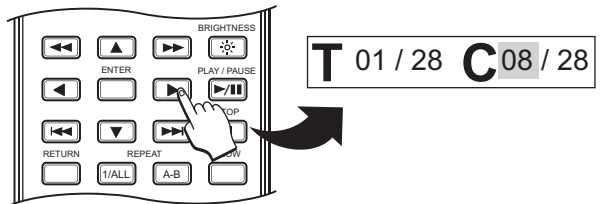

- 3** Use the NUMBER keys to enter the chapter/track you wish to play and then press ENTER. In this example, we'll jump to chapter 25.

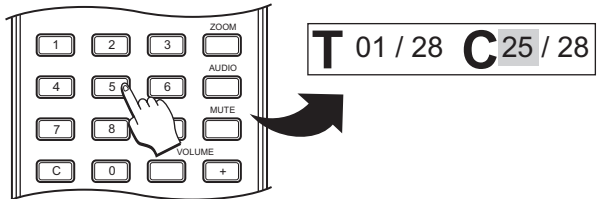

### ! Note

If the ON-SCREEN DISPLAY is present, you must press the DISPLAY key to disable it before using the GOTO function.

## Saving BOOKMARKs for Quick Play

When playing a DVD or other disc, you can “bookmark” points on the disc for playback at a later time. For example, you may want to mark your favorite scenes in a DVD movie to playback after the movie is finished. You can store up to five bookmarks on a disc. Bookmark locations are cleared when the disc is removed. This function also works with VCDs and Audio CDs.

### Saving a Bookmark location

- 1 Press **BOOKMARK** to access the Bookmark Menu. There are 5 locations for bookmark storage. \*You may wish to hit the **PAUSE** key first to freeze playback.

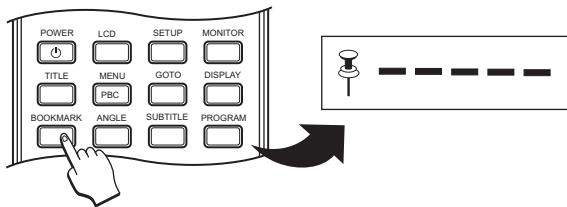

- 2 Use the **LEFT / RIGHT ARROW** keys to select a bookmark location. Here we'll select location 3.

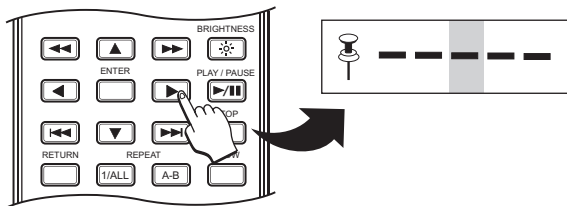

- 3 Press **ENTER** to store the bookmark. Notice that the location is now marked with an **ASTERISK**, indicating a bookmark is stored there. Press **BOOKMARK** to exit.

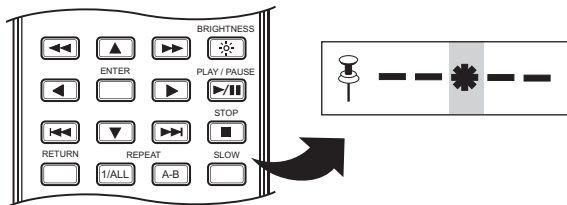

### Playing a Bookmark location

- 1 To playback from a bookmark you have already stored, press **BOOKMARK** and use the **LEFT / RIGHT ARROW** keys to move to the desired location.

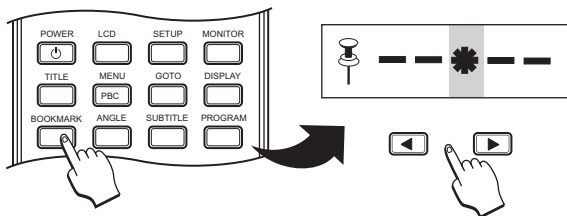

- 2 Press **PLAY** to begin playback of the bookmark.

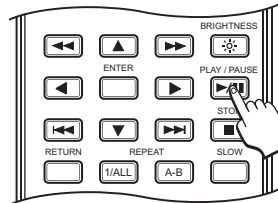

### Clearing a Bookmark location

- 1 To **CLEAR** a bookmark, select the location and press **C**.

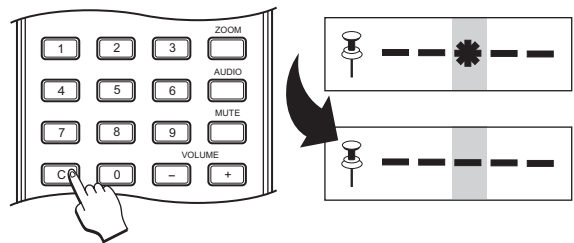

## The DISPLAY Menu

With the DISPLAY MENU you can:

- **View Information** about your disc playback session, including the current Title, Chapter or Track and the Elapsed Time.
- **Navigate** to any Title, Chapter, Track or Time on the disc.
- **Change Playback Options** such as the Audio Track, Subtitles and Current Angle (for discs supporting Multi-Angle).

### Overview of the Display Menu

- 1 Press the **DISPLAY** button during playback to access the **DISPLAY MENU**. With DVD discs, the following options are available.

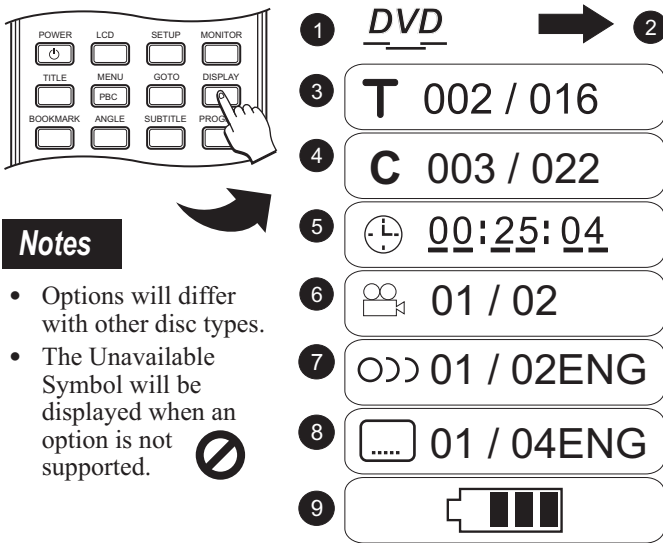

#### Notes

- Options will differ with other disc types.
- The Unavailable Symbol will be displayed when an option is not supported.

#### 1 Disc Type Icon

Displays the current disc type inserted.

#### 2 Playback Mode Icon

Represents the current Playback Mode, which is set with the REPEAT keys (DVD, SVCD, CD-Audio) or the PLAY MODE menu (MP3, JPG).

- ➔ **Normal** - Plays the current disc or directory and then stops.
- 🔄 **Repeat Dir/Disc** - Plays the current Disc or Directory continuously.
- 1 **Repeat Chapter/Track** - Plays the current Chapter or Track continuously.
- 🔀 **Shuffle** - Plays all the files on a Disc or Directory in a random order and then stops. \*MP3, JPG Only.
- 🎲 **Random** - Continuous playback where a random file is selected each time a track is played. \*MP3, JPG Only.

#### 3 Current Title

Displays the Current Title and Total Titles on the disc and allows you to navigate to any Titles.

#### 4 Current Chapter/Track

Displays the Current Chapter/Track and Total Chapters/Tracks on the disc. Also allows you to navigate to any track on the disc.

#### 5 Elapsed Time

Shows the Elapsed Playback Time of the current session. Also allows you to go to any time point on the disc.

#### 6 Angle Mark

Displays the Current Angle and allows you to change to a different angle for DVD discs that support the Multi-Angle feature.

#### 7 Audio Track

Shows the Audio Track currently selected and the Total number of available audio tracks on the disc. You can select from the other audio tracks on the disc.

#### 8 Subtitles

Shows the currently selected Subtitle Language and the Total number of available subtitle languages on the disc. Allows you to change the current subtitle setting.

#### 9 Battery Status

Displays the Battery Charge Status Indicator.

### Using the Display Menu

- 1 Press the **DISPLAY** button during playback to access the **DISPLAY MENU**.

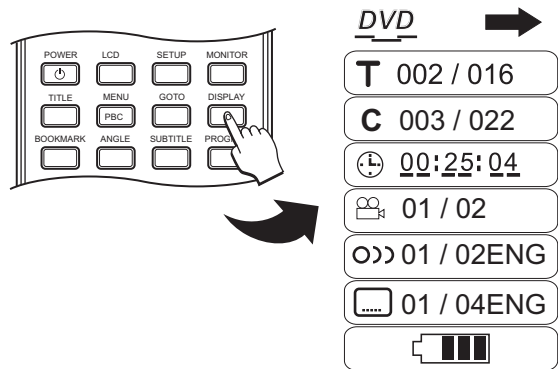

- 2 Press the **UP/DOWN ARROW** keys to move to the desired menu, and the **LEFT/RIGHT** keys to select an option. In this example, we'll change the Subtitle Language to Spanish.

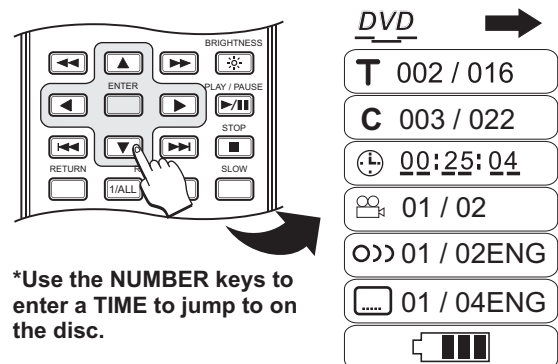

\*Use the **NUMBER** keys to enter a **TIME** to jump to on the disc.

- 3 Press **DISPLAY** at any time to **EXIT** the **DISPLAY MENU**.



# MP3 MUSIC AND JPG IMAGES

## The MP3 / JPG Navigator

When you insert a CD-R/RW disc containing MP3 music files or JPG images, the On-Screen Navigator will start. The Navigator provides an easy-to-use interface allowing you to select which files to play and how to play them. For instance, you can configure the Navigator to display only JPG or only MP3 files, choose to REPEAT a directory during playback, set a RANDOM or SHUFFLE playback mode and more!

### Navigator Overview

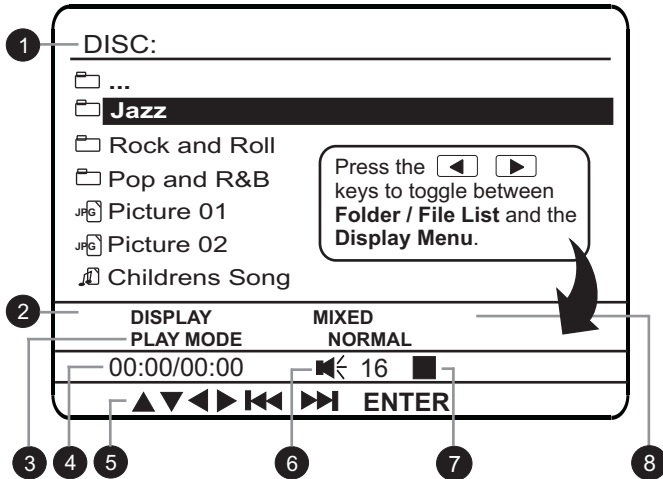

#### 1 Folder/File List

Lists the current folders and files on the disc.

#### 2 Display Menu

Make changes to features and options in this section. Use the RIGHT / LEFT ARROW key to toggle between the Display Menu and Folder/File List.

#### 3 Playmode Options

Press ENTER to select from the various playback options. See page 26 for more.

#### 4 Time Elapsed / Total Track Time Display

Displays time elapsed and total time of track during playback.

#### 5 Button Control Options

Displays buttons available to be used with the Navigator.

#### 6 Volume/Mute Display

Displays the volume level. Press the MUTE key to enable or disable this function.

#### 7 Playback Display

Displays the current playback mode.

#### 8 File List Display Options

Select from various file list options with the ENTER key.

- **MIXED** - Displays all files.
- **MP3 AND JPG** - Displays MP3 and JPG files only.
- **MP3 ONLY** - Displays MP3 files only.
- **JPG ONLY** - Displays JPG files only (use for Slideshows).

## Selecting which files to view

The Navigator has the ability to filter the files on a disc to display only those files you wish to use.

- 1 When a disc is inserted, playback should begin automatically. Press the STOP key to return to the main Navigator screen. By default, the DISPLAY MODE is set to MIXED, with the Navigator showing ALL files on the disc. In this example, we'll change the DISPLAY setting to show only JPG files. This is useful when you wish to view a JPG SLIDESHOW.

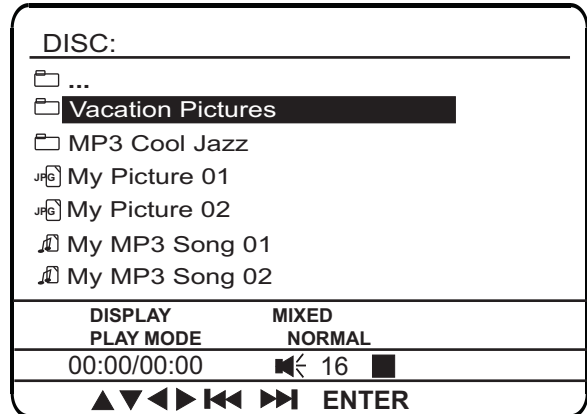

- 2 Press the LEFT ARROW key to move to the DISPLAY setting, then press ENTER twice to select JPG ONLY. Alternatively, you can choose MP3 ONLY to display only MP3 music files.

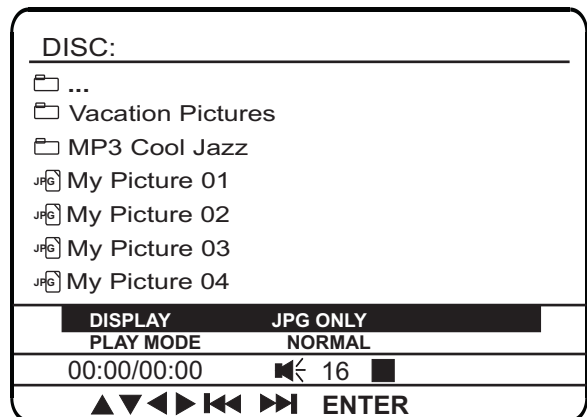

## Notes on MP3 Files

- MP3 files must be stored on discs with the extension "MP3", such as "song1.mp3", otherwise the files will not be recognized.
- CD-R/RW discs containing MP3 files should be in ISO/9660, Mode 1, Closed Session format for best compatibility.

## Changing the PLAY mode

By default, the Navigator will play (MP3) or display (JPG) all files in a directory and then stop when a file is selected and the PLAY key is pressed. Alternatively, you can choose to play one or more files continuously (REPEAT) or change the playback order (RANDOM or SHUFFLE).

- From the main Navigator screen, press the LEFT ARROW to move to the DISPLAY setting, then the DOWN ARROW to move to the PLAY MODE setting. Press ENTER to select a PLAY MODE option. In this example, we'll select REPEAT DIR to display all the JPG images in the root directory repeatedly. This will result in a continuous slideshow during playback.

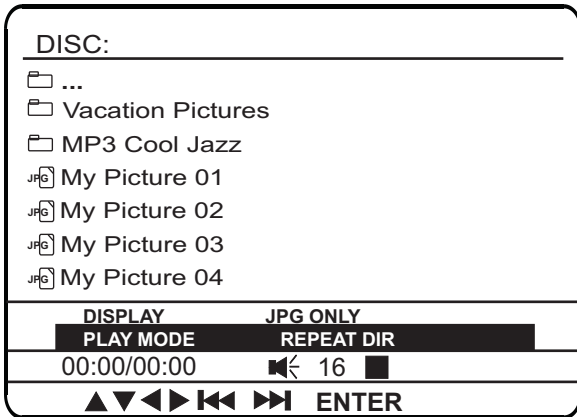

- To begin the slideshow, move back to the file list with the LEFT ARROW key, select a JPG IMAGE to start on and press PLAY. Press STOP at any time to EXIT the slideshow and return to the Navigator.

### ! Note on JPG / SLIDESHOW Playback

The way in which JPG images are displayed (Single Image or Slideshow) depends on which key is pressed to begin play. Press ENTER on a selected JPG file to display only that file. Press PLAY to begin a SLIDESHOW of all the images in the current directory on the disc.

## Changing the JPG SLIDESHOW Interval

If you feel that the pause between images during a slideshow is too long or too short, try using the DISPLAY key to change the time interval.

- During SLIDESHOW playback, press the DISPLAY key. The DISPLAY menu shows an ICON representing the current PLAY MODE, the IMAGE NUMBER / TOTAL IMAGES in the directory and the TIME INTERVAL. \*For more about the DISPLAY MENU, see page 26.

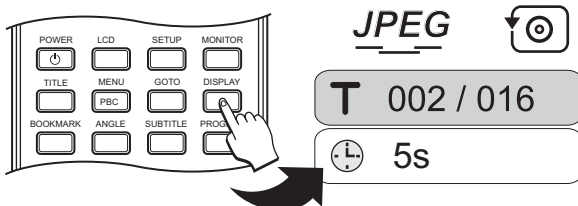

- Use the DOWN ARROW key to move to the TIME INTERVAL setting, then select an option with the RIGHT ARROW key. Available options are 5, 10 or 15 seconds.

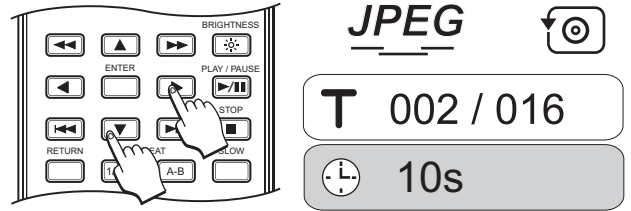

- Press DISPLAY to exit the Display Menu.

## Rotating and Flipping JPG Images

While a JPG is displayed, you can rotate or flip the image horizontally or vertically.

- To rotate an image in the clockwise direction, press the RIGHT ARROW key.

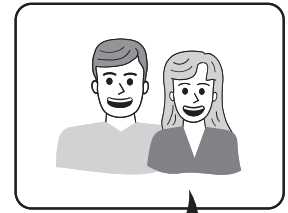
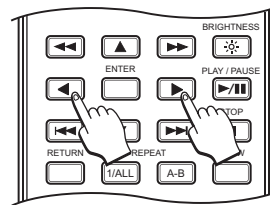

Press the LEFT ARROW to rotate the image counter-clockwise.

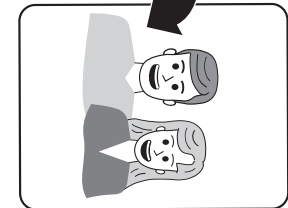

- To flip the image horizontally, press the DOWN ARROW key.

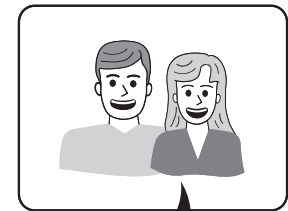
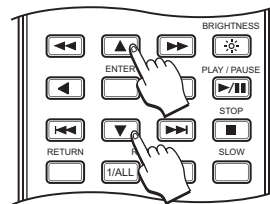

To flip the image vertically, press the UP ARROW key.

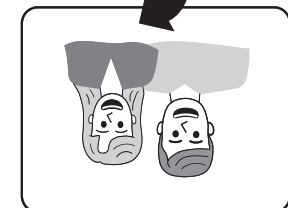

## Using ZOOM with JPG Images

When used with JPG image files, the ZOOM feature lets you choose a particular area of an image to ZOOM-IN on, and repeat the ZOOM function multiple times.

- 1** When the file is displayed, press the ZOOM button. The SELECTION RECTANGLE is displayed on-screen.

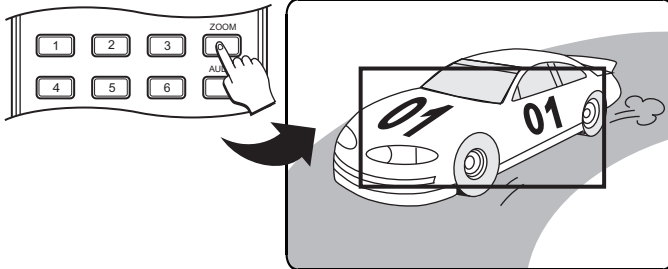

- 2** To select the area of the image you wish to enlarge, use the ARROW keys to move the selection rectangle around the screen.

In this example, we'll move the selection rectangle to the left to select the area of the car's hood.

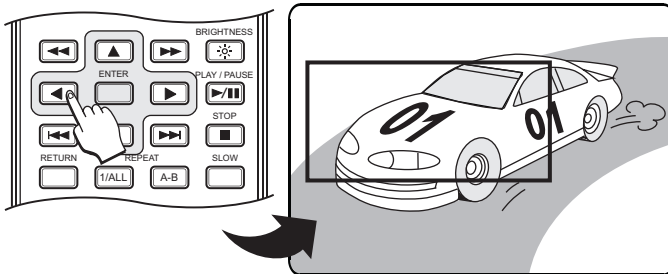

- 3** To increase or decrease the SIZE of the selection rectangle, use the PREVIOUS / NEXT keys.

In this example, we'll use the PREV key to make the selection area smaller.

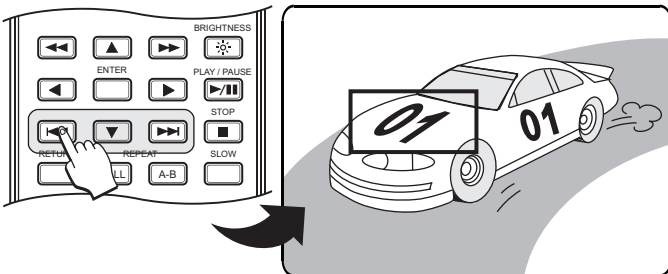

- 4** Finally, press ENTER to enlarge the selected area.

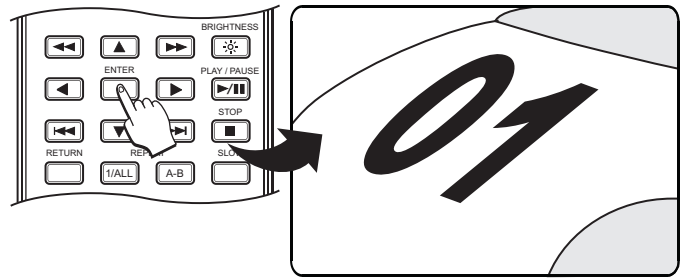

- 5** To EXIT ZOOM mode, press the RETURN key. This will bring the image back to normal viewing.

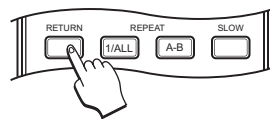

### Notes on JPG Files

- JPG files must be stored on discs with the extension "JPG", such as "picture1.jpg", otherwise the files will not be recognized.
- CD-R/RW discs containing JPG files should be in ISO/9660, Mode 1, Closed Session format for best compatibility.
- JPG files should not be over 1MB in size. JPGs larger than 1MB may not display correctly.

# THE DVD PLAYER SETUP MENU

## Using the SETUP menu

The DVD player's SETUP MENU is where you can configure various settings such as Video Output, Parental Control, Digital Audio Output, Subtitle Control and many more.

In this example, we'll demonstrate how to use the SETUP MENU by changing the CLOSED CAPTION setting from OFF to ON.

- 1 Though the SETUP MENU can be accessed during disc playback, you must press the STOP key twice to have access to all options.

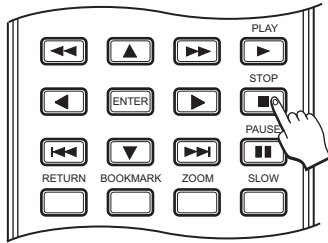

- 2 Press SETUP to enter the SETUP MENU.

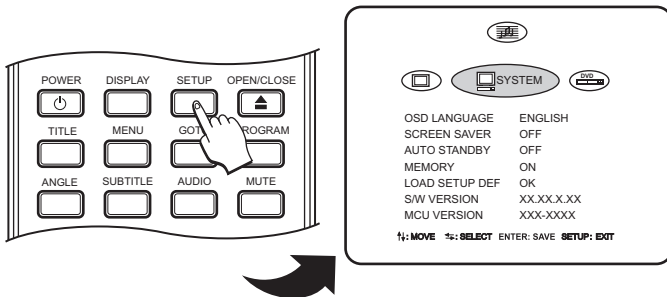

- 3 Use the LEFT / RIGHT ARROW keys to select a sub-menu. In this case, we'll press the LEFT ARROW key to move to the DVD SETUP.

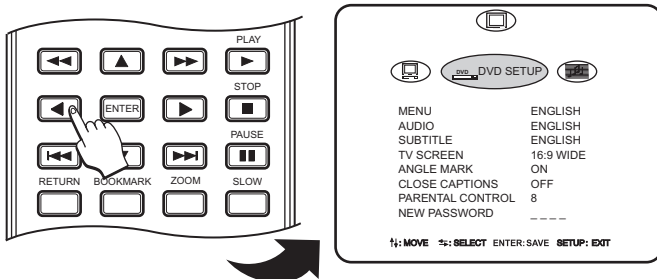

- 4 Next, let's move down to the CLOSE CAPTION setting with the DOWN ARROW key.

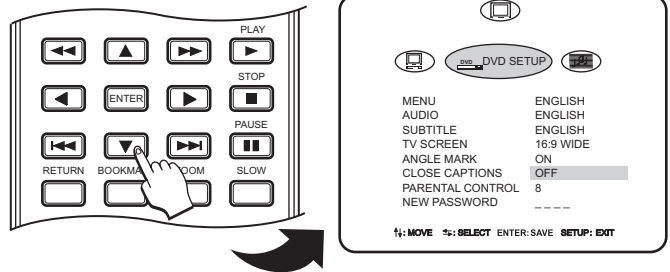

- 5 Now we'll change the CLOSE CAPTIONS setting to ON by using the RIGHT ARROW key.

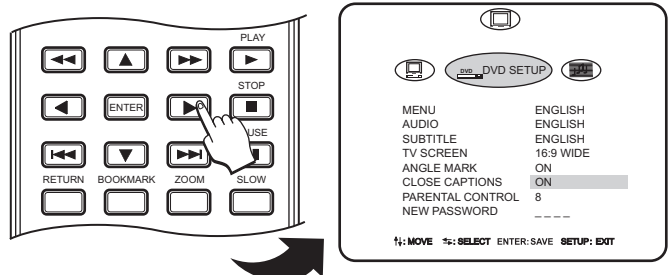

- 6 To confirm the choice, press ENTER. The CLOSE CAPTION setting is now changed.

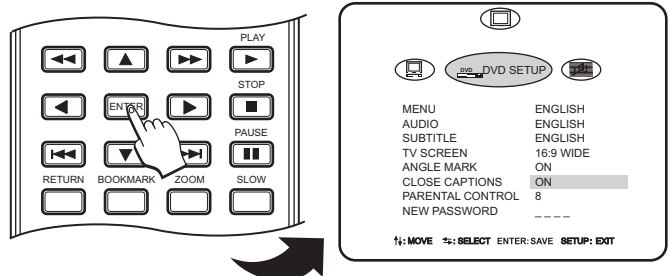

- 7 Exit the SETUP MENU at any time by pressing SETUP.

The **SYSTEM** page

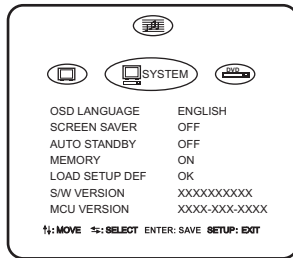

**OSD LANGUAGE**

Default setting: **ENGLISH**

Sets the On-Screen Display language for the Setup Menu.

**SCREEN SAVER**

Default setting: **OFF**

The screen saver will automatically start when set to **ON** after a few minutes of inactivity. To disable this function, set this option to **OFF**.

**AUTO STANDBY**

Default setting: **OFF**

With screen saver set to ON, you have the option to enable Auto Standby. When setting this option to ON, the DVD player will go into Standby mode after 25 minutes.

**MEMORY**

Default setting: **ON**

This setting will remember where you stopped a DVD disc and begin playback from that point when the disc is re-inserted. When disabled, DVD discs will always begin playback at the beginning.

**LOAD SETUP DEF**

Default setting: **OK**

Press the ENTER key to return all settings of your DVD Player's Setup Menu to the factory defaults. This will reset all values for General, Audio, Video and Language settings, with the exception of the Parental Control Password.

**S/W VERSION**

Displays the current software version for the DVD Player.

**MCU VERSION**

Displays the current microprocessor version for the DVD Player.

The **VIDEO** page

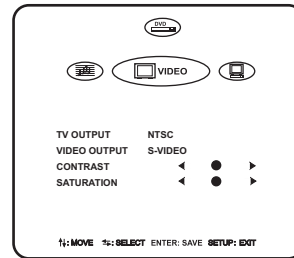

**TV OUTPUT**

Default Setting: **NTSC**

You can setup your DVD Player to work with televisions based on the NTSC and PAL standards as well as televisions designed to function with both standards, or "**AUTO**" models. NTSC is the standard TV system used in the USA, Canada, Japan and many other countries. The **PAL** TV system is used in Europe, Africa, and the Middle East, among other places. Refer to your TV's documentation to make sure which model you have.

**VIDEO OUTPUT**

Default Setting: **S-VIDEO**

Use the default setting of S-Video when making a **COMPOSITE** or **S-VIDEO** connection. Composite is the most common type supported on TV's. Make sure to switch to the appropriate input channel on your TV that corresponds to the Composite or S-Video input, depending on which cable you use. To use the **YCbCr** setting for Component Video output, you must connect the player to a TV using the special 3-to-1 Component Video cable, not included.

**SCAN MODE**

Default Setting: **INTERLACED**

This setting is only available to change after **YCbCr** has been chosen as the VIDEO OUTPUT type. Only high-end P-Scan TVs support **PROGRESSIVE** mode, which scans an entire picture in one pass - as opposed to INTERLACED TVs which scan the even lines in one pass and the odd lines in another. **WARNING:** Change this setting **ONLY** if you are sure your TV supports Progressive Scan.

**CONTRAST**

Adjust the CONTRAST level with the LEFT / RIGHT ARROW keys.

**SATURATION**

Adjust the SATURATION of the video with the LEFT / RIGHT ARROW keys.



**The AUDIO SETUP page**

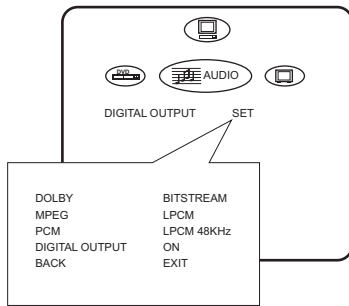

**DIGITAL OUTPUT**

Select the setting **BITSTREAM** or **LPCM** (Linear Pulse Code Modulation) for each Audio format: **DOLBY & MPEG**. Select 48KHz or 96KHz sampling depending on your audio content. Generally the 48KHz is better for most audio, and 96KHz is reserved for super-high quality audio.

The **DIGITAL OUTPUT** setting enables or disables the Optical Digital Output connector.

**The DVD SETUP page**

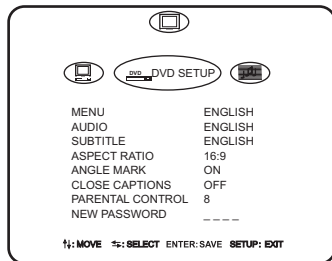

**MENU, AUDIO, SUBTITLE LANGUAGE**

Default setting: **ENGLISH**

Use these settings to set the player's preferred language for DVD Audio tracks, subtitles and menus.

**ASPECT RATIO**

Default setting: **16:9**

This option is set to match the aspect ratio of the display, monitor or TV used with the player. The default setting of **16:9** matches the aspect ratio of the player's LCD display. Use this setting for the LCD or when using the player to output to a Widescreen TV. When using the player's Video Output with a "normal" TV (4:3 aspect ratio), the **4:3 PS** (Pan & Scan) setting or **4:3 LB** (Letterbox) setting should be used, depending on which video format is supported on the DVD disc you are playing.

- This setting should ALWAYS be set to **16:9** when using the player's built-in LCD Display.
- To view DVDs marked as "FULL SCREEN" on the player's LCD, DO NOT change this setting to 4:3. Instead, change the *LCD Mode* to **4:3 Normal** (See Page 10).
- Bars on the top and bottom of the screen will be visible when viewing "Anamorphic" widescreen movies.

**! Note on Aspect Ratio**

Don't confuse the **ASPECT RATIO** setting with the **LCD MODE** (Page 10). The **ASPECT RATIO** setting is set to match the **LCD SCREEN, TV or MONITOR** that the player is using as a video output device. By default this is the player's built-in LCD, which is **16:9 WIDESCREEN** format.

The **LCD MODE** setting depends on the aspect ratio of the **MOVIE** (DVD or SVCD/VCD). Since the player features a **WIDESCREEN LCD**, the picture will appear stretched when viewing non-widescreen material. Change the **LCD MODE** (Page 10) to **4:3 NORMAL** to simulate a normal TV screen when viewing non-widescreen material. This includes "4:3", "FULLSCREEN" or "PAN/SCAN" movie formats.

**ANGLE MARK**

Default setting: **ON**

When used with discs supporting multi-angle features, the Angle Mark continuously displays the current angle you're viewing on screen. Setting **ANGLE MARK** to **OFF** will cancel continuous display, and the current angle will be displayed on-screen for just a few seconds after an angle change.

**CLOSED CAPTIONS**

Default setting: **OFF**

Not all discs support Closed Captions. However, setting **CLOSE CAPTION** to **ON** will result in captions always being displayed when discs supporting captions are used. If you don't wish to automatically enable captions, set this option to **OFF**.

**PARENTAL CONTR**

Default setting: **8**

The Parental Lock allows you to limit the use of your DVD Player to only those DVD discs that do not exceed the rating you specify. When the Parental Control is set, DVD discs that support this feature will play only after the password has been entered. However, typically only discs produced by major entertainment companies support Parental Control. You can choose from eight levels of Parental Control, corresponding to the standard rating system in the USA. You will need to enter a valid password before making changes to Parental Control settings - refer to the section below.

**PASSWORD**

To begin using the Parental Control, enter the factory password of 3351. Once this password is entered, you will be able to change the Parental Control setting or enter an additional user password (the factory password cannot be deleted or changed). To enter your own user password, key in a four digit number into the **NEW PASSWORD** field. The user password and the factory password can now both be used. You can change the user password at any time after entering a valid password. The user password is useful for allowing others - for example a babysitter - temporary access to Parental Control settings.

**! Note on Parental Security**

Remember to keep in mind that the key to the Parental Control feature is the factory default password of 3351. Consequently, your player may not be secure if this manual is accessible by your children.



# TROUBLESHOOTING

Check the following common problems and solutions before requesting service.

## DVD PLAYER DOES NOT POWER ON

- The AC power cord may be loose or not plugged in. Ensure the power cord is secure in the AC socket.
- The unit may be in Stand By mode. Turn the power on with the remote control's POWER key, or turn the unit off, wait a few seconds, then turn the unit on with the front power switch.
- There must be a pause between powering the unit down and back on for a few seconds.

## THE DISC DOES NOT PLAY

- The disc may need cleaning.
- Ensure the disc is not upside down.
- The region code of the disc may not match the player's.

## THE REMOTE CONTROL DOES NOT FUNCTION

- Ensure the remote control is within 30 degrees of the DVD player's remote control sensor located on the front panel.
- Ensure there are no obstacles between the remote control and the DVD player.
- The battery for the remote control may need to be changed.
- You may be out of range for the remote control, try to move closer.

## PICTURE APPEARS STRETCHED OR SQUEEZED

- Make sure the **ASPECT RATIO** setting in the SETUP MENU under DVD SETUP matches the display you're using. When using the Player's built-in LCD, this setting should always be set to **16:9**. If you are using the Video Output with an external TV, this setting should match the TV type: **4:3PS** for Normal TVs and **16:9** for Widescreen TVs.
- Check the VIDEO MODE setting (Page 10) with the FUNCTION key on the front panel or the LCD key on the remote. Set the Video Mode to match the aspect ratio of the movie you're watching: **4:3 Normal** for movies marked "FULL SCREEN" and **16:9** for "WIDESCREEN" movies. If the actors in the movie you're watching appear TOO WIDE, you're probably watching a FULLSCREEN movie with the LCD MODE set to **16:9** instead of **4:3 NORMAL**.

## NO PICTURE ON THE LCD SCREEN

- The player may be set for External Video Display or Video Input Mode. Turn the player off and back on, or press the MONITOR key to switch back to LCD Display Mode.

## BLACK BARS ON TOP/BOTTOM OR SIDES OF SCREEN

- If you see black bars on the SIDES of the screen, the LCD mode is set to **4:3** mode. This is CORRECT if you are viewing a "Fullscreen" DVD movie (made to fill the "fullscreen" of normal non-widescreen TVs). Use the LCD key on the remote or FUNCTION key on the player to adjust the LCD mode.
- If you see black bars on the TOP/BOTTOM of the screen, check to see if the movie format is ANAMORPHIC or 2.35:1 Widescreen (usually shown on the back of the DVD box). If so, the bars are normal because of the wider aspect ratio of the anamorphic format. If the movie format is 16:9, then the **ASPECT RATIO** setting in the player SETUP MENU may be set incorrectly to **4:3**. Change this setting to **16:9**.

## NO PICTURE ON EXTERNAL TV

- Verify the TV's channel is set to match the video input you're using. Please refer to your TV's documentation.
- On most TV's, the "AUX IN", "VIDEO IN", or "AV IN" channel should match the video input connector. If you are using the S-Video connector, the TV may have a separate input channel.
- Press MONITOR to switch to external video output.

## SOME SETTINGS IN THE SETUP MENU ARE UNAVAILABLE

- You must completely stop playback by pressing the STOP key twice.

## DISTORTED PICTURE WHEN CONNECTED TO VCR

- This DVD player is built with Macrovision Copy Protection. Connect your player directly to your TV instead of the VCR.

## THE BATTERY DOES NOT CHARGE (INDICATOR LED DOES NOT LIGHT OR BLINKS)

- The battery can only be charged when the unit is turned off.
- The battery may have reached the end of its service life (approximately 300 cycles).
- If the battery LED is blinking, there could be a connection problem.

## THE PLAYER AUTOMATICALLY TURNS OFF

- Auto Standby is enabled in the BIOS. Disable this setting to prevent the unit from automatically returning to standby mode after 20 minutes of non-use.

# SPECIFICATIONS

## Playable Discs:

- DVD-Video, DVD-R/RW, DVD+R/RW, Audio CD, SVCD, VCD, CD-R & CD-RW

## Playable Formats:

- DVD-Video, SVCD, VCD, MP3, MPEG-2, JPEG

## TV Systems Supported:

- MULTI, NTSC and PAL

## LCD Screen:

- LCD Size . . . . . 7.0 Inch Diagonal
- Aspect Ratio . . . . . 16:9 Widescreen
- Brightness . . . . . 500 Cd/m<sup>2</sup>
- Display Type . . . . . a-Si Active Matrix TFT
- Pixels . . . . . 480 x 234
- Contrast Ratio . . . . . 300:1
- Viewing Angle. . . . . 60° Vertical, 60° Horizontal
- Dot Pitch . . . . . 0.107mm (W) x 0.370mm (H)

## Laser:

- Wavelength 650nm

## DVD Linear Sound:

- 48kHz Sampling . . . . . 4Hz to 22kHz
- 96kHz Sampling . . . . . 4Hz to 44kHz
- Audio CD. . . . . 4Hz to 20kHz

## Signal to Noise Ratio:

- >90dB

## Audio Dynamic Range:

- >80dB

## Harmonic Distortion:

- < 0.015%

## Wow and Flutter:

- ±0.001% ( W.PEAK)

## Component Video Out:

- Y . . . . . 1.0Vp-p (75 Ohm), Negative Sync
- Pb/Pr. . . . . .0.7Vp-p (75 Ohm)
- Output Terminal . . . . . Mini-Jack

## S-Video Out:

- Y Output Level . . . . . 1Vp-p (75 Ohm)
- C Output Level . . . . . .0.88Vp-p (75 Ohm)
- Output Terminal . . . . . Mini-Jack

## Composite Video Out:

- Output Level . . . . . 1Vp-p (75 Ohm)
- Output Terminal . . . . . Mini-Jack

## Analog Stereo Audio Out:

- Output Level . . . . . 1.0VRMS (470 Ohm)
- Output Terminal . . . . . Mini-Jack

## Optical Digital Output :

- Output Terminal . . . . . Mini-Optical

## Operating Conditions:

- 5°C to 35°C (41°F to 95°F)

## Power Supply:

- DC IN Terminal. . . . . DC 9V
- Battery Compartment Terminal . . . . . DC 7.4V

## AC Adapter:

- Power Source . . . . . AC 100~230V, 50/60Hz
- DC Output . . . . . DC 9V, 2.2A

## Power Consumption:

- Normal. . . . . 12W
- Standby . . . . . 6.5W

## Battery:

- Cell . . . . . 4 piece 1550mAh in 2P 2S configuration
- Voltage . . . . . 7.4 V
- Capacity . . . . . 3100mAh
- Internal Impedance . . . . . < 200 m ohms
- Estimate Cycle Life . . . . . 300 cycles (Approx)
- Battery Life . . . . . Approx. 2.5Hours\*  
\*Depends on Usage
- Charge Time . . . . . 3~4 hours

## Battery Operating Temperature:

- Charging . . . . . 0 ~ 45° C
- Discharging . . . . . -20 ~ 60° C
- Storage . . . . . -20 ~ 50° C, RH = 60 ± 20 %

## Battery LED Indicator:

- Charging . . . . . Red
- Fully Charged . . . . . Green

## Dimensions:

- Player . . . . . 184mm x 35mm x 144mm (W x H x D)  
7.24" x 1.38" x 5.67" (W x H x D)
- Battery . . . . . 110mm x 12mm x 72mm (W x H x D)  
4.33" x 0.47" x 2.83"(W x H x D)

## Weight:

- Player . . . . . 677g (1.49 lbs)
- Battery . . . . . 190g (0.418 lbs)

## \*Notes:

Weight and dimensions are approximate  
Part No: 700Be

Specifications are subject to change without notice. While due caution has been exercised in the production of this document, inadvertent technical inaccuracies or typographical errors are possible and unintentional. While all efforts have been made to ensure accuracy, CyberHome Entertainment will not be held liable for any inaccuracies or errors in the information contained herein.

# INDEX

- a-b repeat . . . . . 22
- ac adapter . . . . . 14
- angles (multi-angle playback) . . . . . 22
- audio button . . . . . 22
- audio outputs . . . . . 17
- audio settings . . . . . 32
- aspect ratio . . . . . 10, 32, 33
  
- battery (remote control) . . . . . 7
- battery (player)
  - replacing . . . . . 12
  - charging . . . . . 3, 13
  - indicator . . . . . 11
- back panel connections . . . . . 16
- bookmarks . . . . . 25
  
- component video . . . . . 16
- composite video . . . . . 15
- connections
  - audio outputs . . . . . 17
  - a/v inputs . . . . . 18
  - TV . . . . . 15-17
  
- car adapter . . . . . 14
- connections . . . . . 11
- contents (package) . . . . . 6
  
- disc compatibility . . . . . 5
- discs (care) . . . . . 5
- display function . . . . . 26
- dvd settings . . . . . 31
  
- enter button . . . . . 8
  
- fast forward . . . . . 21
- features . . . . . 5
- front panel . . . . . 9
- fullscreen movies . . . . . 10
- function button . . . . . 9
- function menu . . . . . 10
  
- goto . . . . . 24
  
- headphones . . . . . 14
  
- index . . . . . 35
- inserting a disc . . . . . 19
  
- jpg images . . . . . 27-29
  
- language . . . . . 32
- lcd mode . . . . . 10, 18
- lcd (turning off) . . . . . 18
  
- menu button . . . . . 20
- monitor button . . . . . 9, 16
- mp3 . . . . . 27
- mute button . . . . . 8
  
- number buttons . . . . . 8
  
- optical audio out . . . . . 17
- OSD language settings . . . . . 32
  
- pan/scan . . . . . 32
- pause key . . . . . 20
- parental lock . . . . . 32
- password . . . . . 32
- plastic tab . . . . . 7
- play key . . . . . 20
- power . . . . . 19
- power cord . . . . . 14
- program play . . . . . 23
- progressive scan . . . . . 18, 31
  
- random play . . . . . 26, 28
- region codes . . . . . 5
- remote control
  - preparing . . . . . 7
  - buttons . . . . . 8
  - using . . . . . 7
- repeat playback . . . . . 22
- reset
  - SETUP Factory Defaults . . . . . 32
  - video output . . . . . 31
- return key . . . . . 20
- rf modulator . . . . . 15
  
- safety instructions . . . . . 2
- safety instructions (battery) . . . . . 2
- screen saver . . . . . 20
- setup menu . . . . . 30-32
- shuffle play . . . . . 26, 28
- skip ahead/back . . . . . 9, 21
- slow motion . . . . . 21
- specifications . . . . . 34
- standby power . . . . . 19
- stop . . . . . 20
- subtitles . . . . . 22
- s-video . . . . . 16
  
- table of contents . . . . . 4
- troubleshooting . . . . . 33
  
- video outputs . . . . . 16
- video settings . . . . . 31
  
- widescreen movies . . . . . 10, 32
  
- zoom (dvd) . . . . . 23
- zoom (jpg) . . . . . 29

## Free Manuals Download Website

<http://myh66.com>

<http://usermanuals.us>

<http://www.somanuals.com>

<http://www.4manuals.cc>

<http://www.manual-lib.com>

<http://www.404manual.com>

<http://www.luxmanual.com>

<http://aubethermostatmanual.com>

Golf course search by state

<http://golfingnear.com>

Email search by domain

<http://emailbydomain.com>

Auto manuals search

<http://auto.somanuals.com>

TV manuals search

<http://tv.somanuals.com>