

USE AND CARE MANUAL

RENAISSANCE® ELECTRIC RANGE

WITH INDUCTION COOKTOP

Models: RR30NS[-C], RR30NFS[-C], RR30NIS[-C] and RR30NIFS[-C]



Style varies, model RR30NFS shown

Table of Contents

Important Safety Instructions	1
Getting to Know Your Range	4
Operating the Cooktop	7
Operating the Oven	9
Care and Cleaning	20
Before You Call for Service.....	25
Parts and Accessories	27
Warranty and Service	27
Warranty Card	Back Cover





To Our Valued Customer:

Congratulations on your purchase of the very latest in Dacor® products! Our unique combination of features, style and performance make us The Life of the Kitchen™, and a great addition to your home.

In order to familiarize yourself with the controls, functions and full potential of your new Distinctive Appliance, read this use and care manual thoroughly, beginning with the **Important Safety Instructions** section.

All Dacor appliances are designed and manufactured with quality and pride, while working within the framework of our company value. Should you ever experience a problem with your product, please first check the **Before You Call for Service** section of this manual for guidance. It provides useful suggestions and remedies prior to calling for service.

Valuable customer input helps us to continuously improve our products and services, so please feel free to contact our Customer Service Team for assistance with any of your product support needs.

Dacor Customer Service Team
14425 Clark Avenue
City of Industry, CA 91745

Telephone: (800) 793-0093
Fax: (626) 403-3130
Hours of Operation: Monday through Friday
6:00 A.M. to 5:00 P.M. Pacific Time
Web Site: www.dacor.com

Thank you for choosing Dacor for your home. We are a company built by families for families and we are dedicated to serving yours. We are confident that your new Dacor product will deliver a high level of performance and enjoyment for many years to come.

Sincerely,

The Dacor Customer Service Team

Important Safety Instructions

Installer: Leave these instructions with the appliance.

Consumer: Read this use and care manual completely before using this appliance. Save it for future reference.

For service and warranty information, see page 27.

If you have any questions call:

Dacor Customer Service

Phone: (800) 793-0093 (U.S.A. and Canada)

Monday — Friday 6:00 A.M. to 5:00 P.M. Pacific Time

Web site: www.dacor.com

Have the complete model and serial number for your range ready. The product model and serial number label can be seen through the grill below the control panel, on the right side. Write these numbers below for easy access.

Product model and serial number label, (view through right side of grate with flashlight)

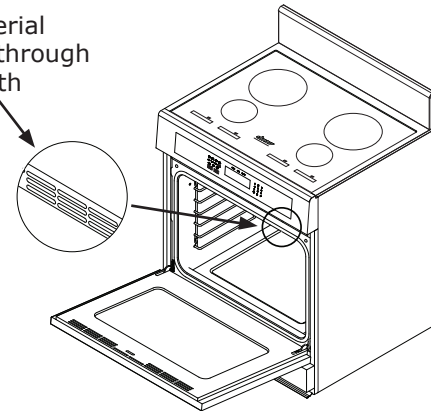

Model number _____

Serial number _____

Date of purchase _____

About Safety Instructions

The **Important Safety Instructions** and warnings in this manual are not meant to cover all possible problems and situations that can occur. Use common sense and caution when installing, maintaining or operating this or any other appliance.

Always contact the Dacor Customer Service Team about problems or situations that you do not understand.

Safety Symbols and Labels

DANGER

Immediate hazards that **WILL** result in severe personal injury or death.

WARNING

Hazards or unsafe practices that **COULD** result in severe personal injury or death.

CAUTION

Hazards or unsafe practices that **COULD** result in minor personal injury or property damage.

WARNING

If the information in this manual is not followed exactly, a fire or explosion may result causing property damage, personal injury or death.

WARNING

Persons with a pacemaker or other medical device should use caution when standing near an induction cooktop when it is in use. The electromagnetic field generated by an induction cooktop may affect operation of a pacemaker or other medical device. Consult your doctor or medical device manufacturer about your particular situation.

WARNING

WARNING - NEVER cover any slots, holes or passages anywhere on the range or cover an entire oven rack with materials such as aluminum foil. Doing so blocks air flow through the range and may result in overheating of the appliance. Aluminum foil linings may also trap heat, causing a fire hazard.

WARNING

WARNING - NEVER use this appliance as a space heater to heat or warm the room. Doing so may result in overheating of the appliance.

WARNING

Tip-over hazard:

- A child or adult can tip the range and be killed.
- Verify that the anti-tip bracket has been properly attached to the floor or wall as directed in the installation instructions. Using a flashlight, verify that the range's rear leg is engaged with the anti-tip bracket as shown below.
- After moving the range, be sure to re-engage the rear leg with the floor or wall mounted anti-tip bracket as shown below.
- Do not operate the range without the rear leg engaged with the anti-tip bracket.
- Failure to follow these instructions can result in death or serious burns to children and adults.

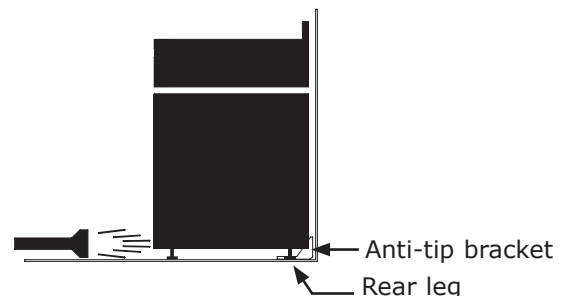

READ AND SAVE THESE INSTRUCTIONS

Important Safety Instructions

General Safety Precautions

To reduce the risk of fire, electric shock, serious injury or death when using your range, follow basic safety precautions, including the following:

DANGER

IMPORTANT: To avoid the possibility of explosion or fire, do not store or use combustible, flammable or explosive vapors and liquids (such as gasoline) inside or in the vicinity of this or any other appliance. Also keep items that could explode, such as aerosol cans away from the cooktop and oven. Do not store flammable or explosive materials in adjacent cabinets or areas.

WARNING

- If you receive a damaged product, immediately contact your dealer or builder. Do not install or use a damaged appliance.
- Make sure that the range has been properly installed and grounded by a qualified installer according to the accompanying installation instructions. Have the installer show you the location of the circuit breaker panel or fuse box so that you know where and how to turn off power to the range.
- Do not install, repair or replace any part of the range unless specifically recommended in the literature accompanying it. A qualified service technician should perform all other service.
- Only use the range for cooking tasks expected of a home appliance as outlined in this manual. This range is not intended for commercial use.
- Never allow anyone, including children to sit, stand or climb on any part of the range, including the door. Doing so may cause tipping, damage, serious injury or death.
- CAUTION - Do not store items of interest to children in cabinets above the range or on the backguard of the range. Children climbing on the range to reach items could be seriously injured.
- Do not tamper with the controls.
- Never leave cooktop elements unattended at high heat settings. Boil-over causes smoking and greasy spill-overs that may ignite.
- Keep flammable items, such as paper, cardboard, plastic, cloth (including potholders) away from hot surfaces. Do not place such items in the oven.
- Do not place or store items that could melt or catch fire on the cooktop or in the oven, even when the range is not in use.
- Do not wear loose or hanging apparel when using the range. Do not allow clothing to come into contact with the cooktop, oven interior or surrounding areas during and immediately after use.
- To avoid overheating, do not allow pans to boil dry.

WARNING

- Do not hang flammable or heat sensitive objects over the range. If the range is near a window, do not use long curtains as window treatment. The curtains could blow over the cooktop and create a fire hazard.
- For your safety, do not use the oven to cook without the convection filter installed. When the filter is not installed, the spinning fan blades at the back of the oven are exposed.
- When deep fat frying:
 - Be certain that the pan is large enough to contain the desired volume of food without overflow caused by the bubbling of the fat. Never leave a deep fat fryer unattended.
 - Avoid frying moist or frost-covered foods. Foods with high water content may cause spattering or spilling of the hot fat.
 - Heat fat slowly, and stir together any combination of oils and fats prior to applying heat. Utilize a deep fat frying thermometer to avoid heating the fat to temperatures above the flash point.
 - Let fat cool before attempting to handle it.
 - Wipe up spill-overs immediately.
- DO NOT TOUCH THE SURFACES OF THE OVEN OR COOKTOP DURING OR IMMEDIATELY AFTER USE. Surface elements may be hot even though they are dark in color. Use potholders to handle hot utensils.
- Hold the handle of the utensil to prevent movement when stirring or turning food.
- Use cookware only for its intended purpose. Check the manufacturer's recommendations before use to determine if a utensil is suitable for use on a cooktop or in an oven. Personal injury or damage may result from the improper use of cookware.
- Glazed cookware not designed for high heat use may crack or break, causing a spill or burn hazard. Before using glazed cookware, such as glass, ceramic or earthenware, check the manufacturer's temperature and usage recommendations.
- This appliance is equipped with heating elements of different sizes. Select utensils having flat bottoms large enough to cover the heating element. The use of undersized utensils will expose a portion of the heating element to direct contact and may result in ignition of clothing. Proper relationship of utensil to element will also improve efficiency.
- Exercise caution when opening the oven door. Let hot air or steam escape before looking or reaching into the oven.
- Do not use towels or bulky cloth as potholders.

Important Safety Instructions

WARNING

- Use extreme caution if adding water to food on a hot cooktop or in the oven. The steam can cause serious burns or scalds.
 - Do not use the cooktop to heat aluminum foil, aluminum pots or items wrapped in aluminum foil.
- GREASE IS FLAMMABLE AND SHOULD BE HANDLED CAREFULLY. TO REDUCE THE RISK OF INJURY TO PERSONS IN THE EVENT OF A RANGE TOP GREASE FIRE:
- a. SMOTHER FLAMES with a close-fitting lid, cookie sheet or metal tray, then turn off the element. BE CAREFUL TO PREVENT BURNS. If the flames do not go out immediately, EVACUATE AND CALL THE FIRE DEPARTMENT.
 - b. NEVER PICK UP A FLAMING PAN - you may be burned.
 - c. DO NOT USE WATER, including wet dish cloths or towels - a violent steam explosion may result.
 - d. If you are "flaming" liquors or other spirits under an exhaust, **turn the fan off**. The draft could cause the flames to spread out of control.
 - e. Use a fire extinguisher ONLY if:
 - You have a Class ABC extinguisher, and you already know how to operate it.
 - The fire is small and contained in the area where it started.
 - The fire department is being called.
 - You can fight the fire with your back to an exit.
 - f. In the event that personal clothing catches fire, **drop and roll immediately** to extinguish flames.
- Use only dry potholders when removing food and cookware from the cooktop or oven. Wet potholders can cause steam burns. Do not let potholders come into contact with hot heating elements.
 - Do not use utensils that do not attract and hold a magnet and never use a steel plate or griddle to heat a nonmagnetic utensil, which can cause INJURY or DAMAGE to the cooktop elements and controls.
 - Do not heat eggs or unopened food containers such as baby food jars and cans. Pressure build up may cause them to burst and cause injury.
 - Do not leave children or pets alone or unattended in the area around the range. Do not allow children to play with the controls, pull on the handle or touch other parts of the range.
 - Make sure individuals who use the range are able to operate it properly.
 - Clean the range thoroughly before operating it for the first time.
 - Clean and maintain the range regularly as instructed in this manual. Keep the entire range, ventilation filters and range hoods free of grease that could catch fire.

WARNING

- Do not allow food to sit in the oven for more than one hour before or after cooking. Eating spoiled food can result in food poisoning.
- Do not cook on a broken cooktop. If the cooktop should break, cleaning solutions and spill-overs may penetrate the broken cooktop and create a risk of electric shock. Contact a qualified technician immediately to replace a damaged/pitted cooktop.
- Non-stick coatings, when heated, can be harmful to birds. Remove birds to a separate, well-ventilated room during cooking.
- CAUTION: DO NOT LEAVE FOOD, COOKING UTENSILS, OVEN RACKS, THE CONVECTION FILTER, ETC., IN THE OVEN DURING THE SELF CLEAN CYCLE.
- ATTENTION : NE LAISSER AUCUN ALIMENT, UTENSILE DE CUISINE, GRILLES DU FOUR, LE FILTRE DE CONVECTION, ETC., DANS LE FOUR DURANT LE CYCLE D'AUTONETTOYAGE.

CAUTION

- Do not allow acids (citrus juices, tomato sauces, etc.) to remain on the range's surfaces. The finishes may stain.
- Do not slide cookware across the cooktop. Sliding may damage the finish. Lift utensils to reposition them. Utensils with rough surfaces should be avoided since they can scratch the glass surface.
- Never use the cooktop surface as a cutting board.
- Do not try to remove heavy spills with a sharp object such as a knife or metal spatula. Sharp objects may scratch the range's surfaces.
- Do not line the oven with aluminum foil or other materials that can melt or burn up during self cleaning and cause permanent damage to the oven.
- Do not leave objects, such as aluminum foil, the meat probe, cookie sheets, etc. on the bottom of the oven. Objects left on the bottom of the oven may cause damage.
- Do not allow the broil element on the oven ceiling to become covered up by cookie sheets, aluminum foil, pots, pans, etc. Doing so may cause overheating and damage the oven.
- To prevent damage, do not allow aluminum foil or the meat probe to come into contact with heating elements.
- Always ensure that the light fixture lens cover is in place when using the oven. It protects the light bulb from breakage caused by high oven temperatures or mechanical shock.

At Dacor, we continuously improve the quality and performance of all our products. As a result, we may need to make changes to this appliance without updating these instructions. Visit www.dacor.com to download the latest version of this manual.

Getting to Know Your Range

Parts of the Oven

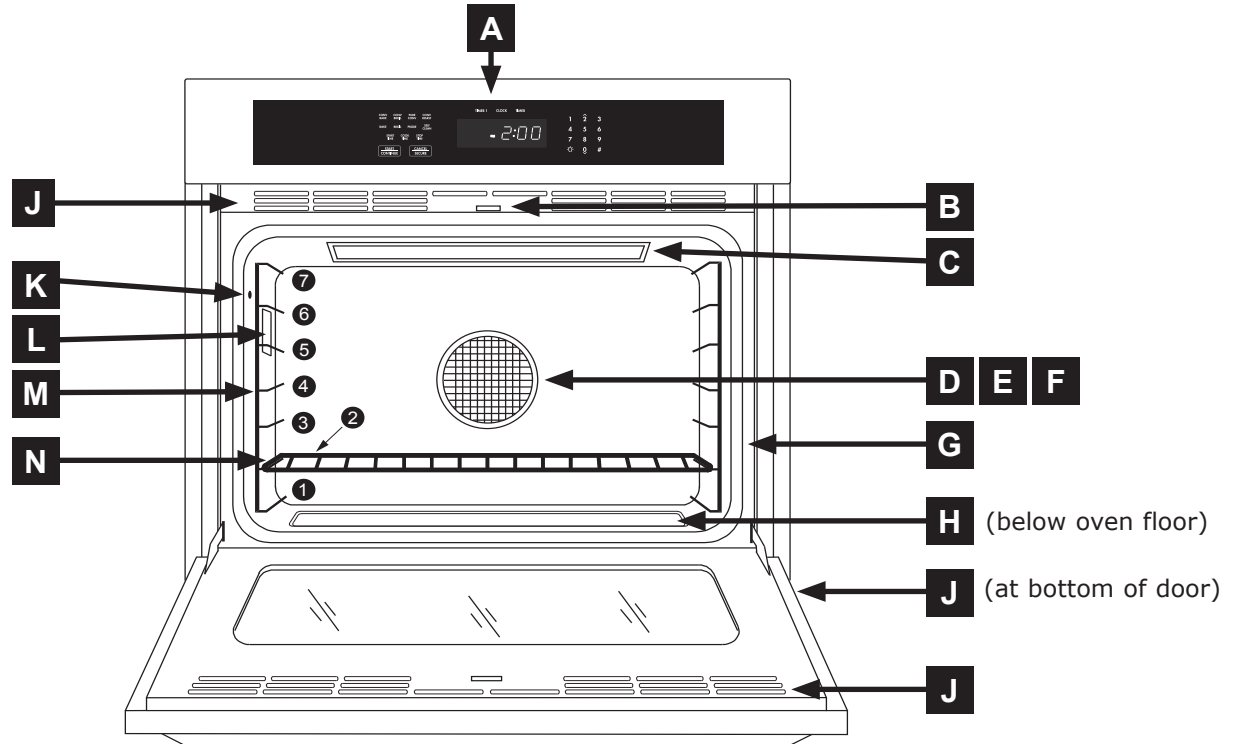

A	Control panel	The control panel consists of keys and a display. Use the control panel to control all the oven's features (sometimes called modes).
B	Self clean latch	The self clean latch automatically locks the oven door during the self clean cycle. The door latches for your safety. There are very high temperatures inside the oven during the self clean cycle.
C	Broil element	The broil element is located on the ceiling of the oven chamber. It is the source of top heat.
D	Convection element	The convection element heats the air that is circulated through the oven chamber by the convection fan during the convection cooking process.
E	Convection fan	The convection fan circulates heated air through the oven chamber during the convection cooking process. The convection filter covers it.
F	Convection filter	The convection filter covers the convection fan. It helps prevent the transfer of taste from one food to another when you are cooking a whole meal. It also keeps the oven cleaner and covers the moving fan blades for safety purposes.
G	Door gasket	The door gasket prevents heat from escaping when the door is closed.
H	Bake element	Hidden below the floor of the oven chamber is the bake element. It is the source of bottom heat.
J	Air intake/Exhaust slots	The range draws air in through the intake slots to cool its internal parts. The air comes out through the exhaust slot at the bottom of the oven door. Do not block or cover the air intake or exhaust slots.
K	Meat probe connector	When you use the meat probe, insert the skewer into the meat and plug the other end into this connector. See Using the Meat Probe on page 16 for proper operation.
L	Oven light	There is a light inside the oven chamber so that you can easily see the food inside. Press the light key on the control panel to turn it on. The bulb is 120 Volt, 20 Watt, halogen.
M	Rack supports	There are seven rack positions inside the oven chamber. The rack positions are numbered counting up from the bottom.
N	Oven rack	Your oven comes with two GlideRack™ oven racks.

Getting to Know Your Range

Control Panel Layout

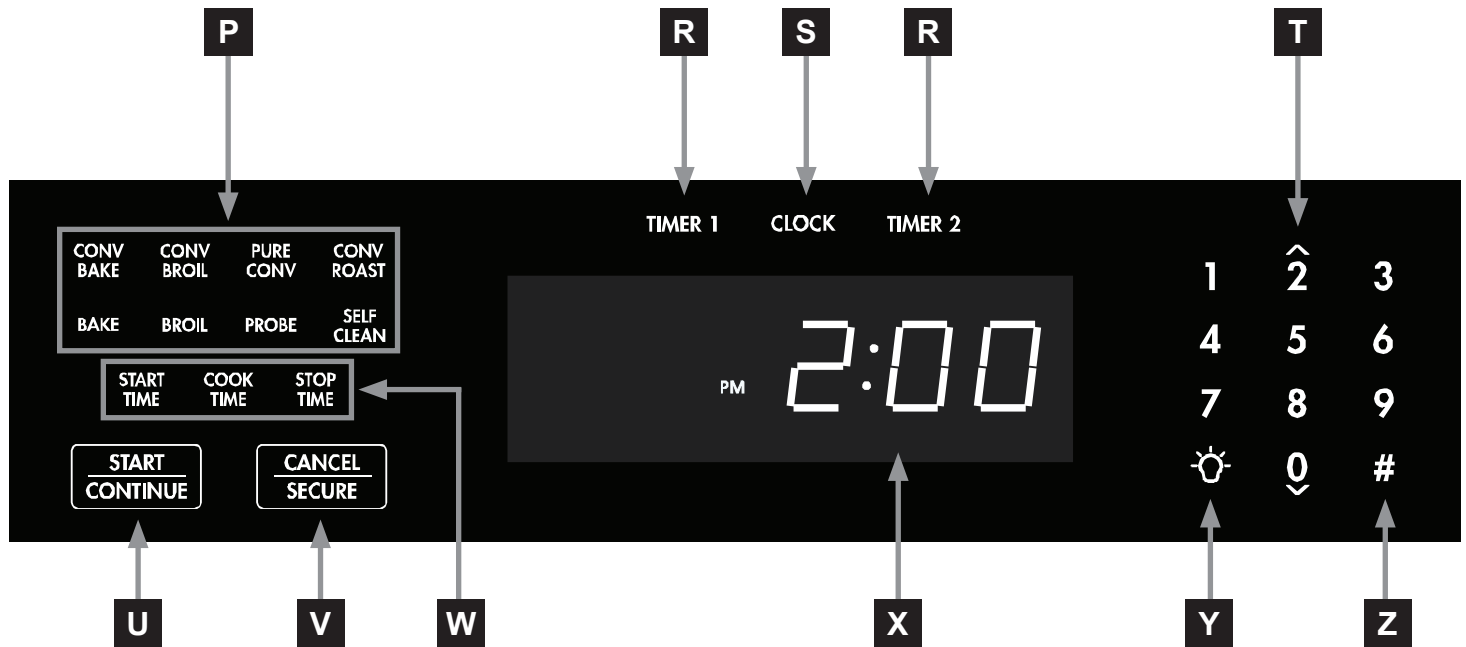

P	Cooking mode keypad	Select the type of cooking you want to perform by pressing one of the cooking mode keys. Also includes the SELF CLEAN and PROBE keys.
R	TIMER keys	Use the TIMER 1 and TIMER 2 keys to time an event. The two timers operate separately from each other. You can use them even if the oven is not in use. They do not turn the oven on or off. See page 13.
S	CLOCK key	Use this key to set the clock. See page 8.
T	Number keypad	The number keypad is used to set the temperature, cook time or the clock. See Operating the Oven .
U	START · CONTINUE key	When you use the various features (or modes) on your oven, select the cooking mode first, then press the START · CONTINUE key. Also, use the START · CONTINUE key to start the timers. See Operating the Oven .
V	CANCEL · SECURE key	Use this key to turn off your oven. This key sets all temperature settings back to zero and turns off any features (except the timer) that are currently in use. It also activates the lock-out feature.
W	Delay timed cooking keys	Use these keys to set the oven to turn on or off automatically at a later time. See page 14 for instructions.
X	Display	The control panel display provides various types of information about the oven, including the current time (once the clock is set), the current cook settings and the cooking temperature. See below for the symbols that appear on the display.
Y	Light key	Located on the number keypad. If you need to turn the oven light on or off, press the light key.
Z	Sabbath key (#)	Use this key to start Sabbath mode. See page 15.

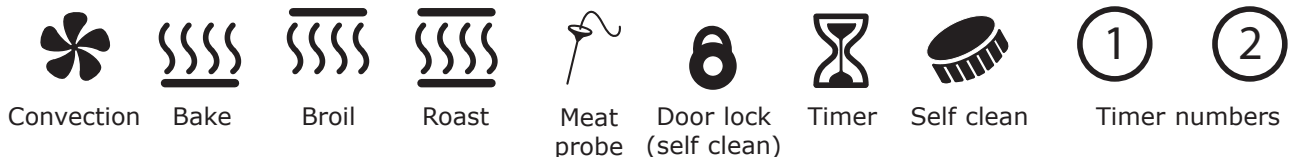

Display Symbols

Getting to Know Your Range

About the Cooktop

- Your range is equipped with an induction type cooktop. Induction cooking is totally different from traditional types of cooking. A magnetic induction element below the cooking surface heats utensils (magnetic only) directly. Induction cooking is much more efficient because less energy is lost heating the cooktop itself. Also, food that spills on the cooktop does not burn since the cooktop is much cooler.
- The cooktop has four circular cooking zones. Below each cooking zone is the magnetic induction cooking element. Each cooking zone has its own set of controls. The control keys are activated by touching them with your fingertip. Pressing hard is not necessary because the keys are not pressure sensitive. **NOTE:** Spills or cleaning solutions on the keys can cause unwanted operation. Dry the control area with a clean cloth and reset the control to correct.
- All of the induction elements under the cooking zones feature temperature limiters to ensure a safe operating temperature for the glass ceramic top. The elements automatically cycle on and off. At higher power settings, the induction element will stay on for longer periods of time.

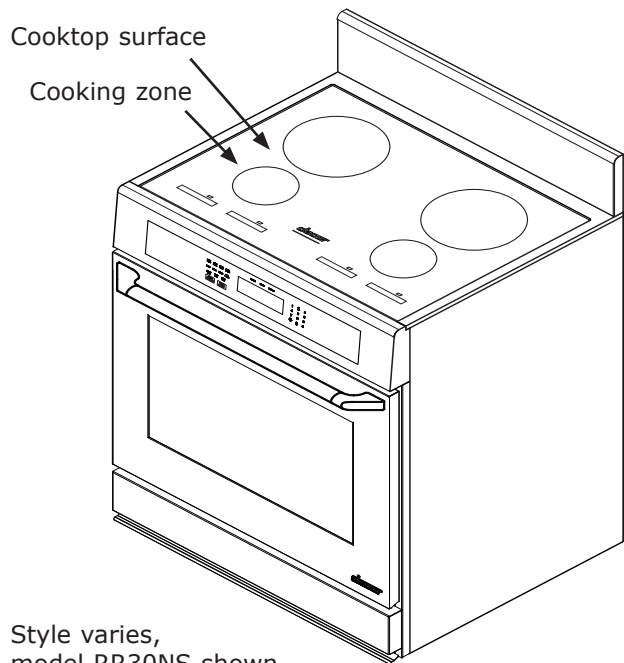

Cooktop Control Panel

- A ON/OFF Key:** Turns on the indicated cooking zone.
- B Cooking Zone Position:** Indicates the location of the cooking zone that is adjusted by that set of controls.
- C Power Light:** Turns on when the indicated cooking zone is on. Power turns off automatically if a utensil is not placed on the cooking zone within 30 seconds of being turned on.
- D Power Level Display:** Shows the current power level and flashes when no utensil is placed on the cooking zone. Available cooking levels are L, 1, 2, 3, 4, 5, 6, 7, 8, 9, H*.
- E Hot Surface Indicator Light:** Indicates corresponding cooking zone is hot.
- F Power Level DOWN Key:** Touch this key repeatedly to lower the power level.
- G Power Level UP Key:** Touch this key repeatedly to raise the power level.
- H LOW Key:** Touch this key to jump directly to power level "2".
- J MEDIUM Key:** Touch this key to jump directly to power level "6".
- K HIGH Key:** Touch this key to jump directly to "H" power level.

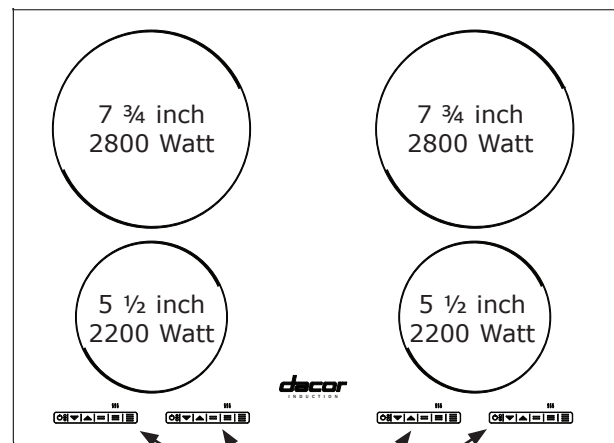

Cooktop Layout - Top View

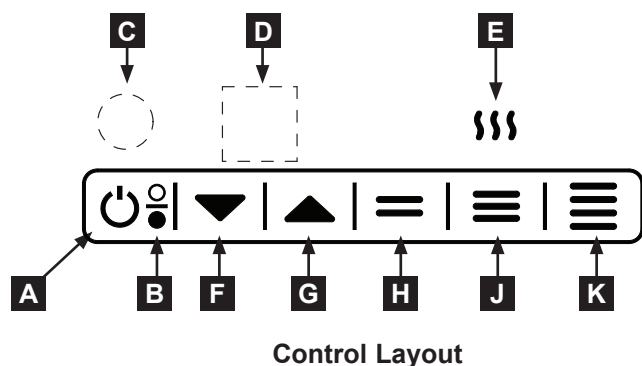

*The Dacor induction power management feature regulates the amount of power one side (left or right) can draw at the same time. If you set both controls on the same side to the **HIGH** power setting, power to both elements will be reduced slightly and cooking times will be slightly longer. When cooking on two elements at the **HIGH** setting, Dacor recommends using one element on the left side and one on the right.

Operating the Cooktop

Before Using the Cooktop

Before using the cooktop for the first time:

- Be sure all packing materials, labels or tape are removed from the cooktop surface.
- Wipe the cooktop with a clean, damp sponge and dry.
- Apply Dacor Cooktop Cleaning Crème, according to the **Care and Cleaning** section.
- During the first uses of the cooktop, you may smell a slight burning odor or see light smoke. These conditions are normal for new glass ceramic cooktops.
- Be certain that the cookware and glass surfaces are clean and dry before you place a pot or pan on the cooktop and turn on an element.

Selecting the Proper Cookware

WARNING

This appliance is equipped with one or more surface units of different size. Always use utensils that have flat bottoms. Use utensils that best match the surface unit size (smaller utensils on smaller surface units) and are a minimum of four inches in diameter.

- All utensils used on an induction cooktop **MUST** be magnetic.
- Utensils will affect the overall safety and performance of cooktop cooking, so it is important to select them carefully. An improperly selected utensil will not cook efficiently or evenly.
- Use medium to heavy-gauge metal cookware with flat and smooth bottoms. Also choose cookware that closely matches the diameter of the cooking zone. Use utensils with tight fitting lids to retain heat, odors and steam.
- Properly center utensils in the cooking zone for proper operation.

Do not use:

- Cooking utensils that have bottoms that are rounded, convex or concave.

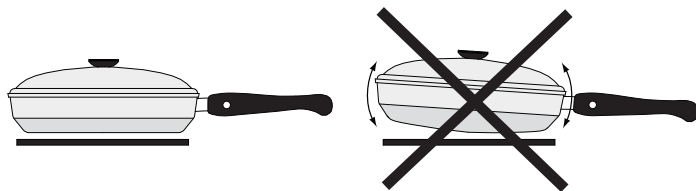

- Utensils that are smaller in diameter than the cooking zone being used.
- Utensils made of materials that are poor heat conductors.
- Griddle plates that cover more than one cooking zone.
- Dirty pans or pans with greasy build-up.

Improper utensils will not heat properly, wobble and may cause vibration.

Operating the Controls

WARNING

- Turn on the induction cooktop only after placing the cookware on the element.
- Do not leave metallic utensils or lids on the cooking surface since they can become hot.
- Make sure the cooktop surface is clean and dry.
- Place the pan on the element selected, center for best operation.
- Locate the **ON/OFF** key operating the selected cooking zone and touch it with your finger for one second. Remove your finger when the power light turns on. The power level display will flash "0".
- Select the desired power level using the **LOW**, **MEDIUM** or **HIGH** keys or using the **UP** () key. The selected power level will appear on the display.

NOTE:

- ◇ If a power level is not selected within 30 seconds, the control will turn off.
- ◇ You can change the power level setting at any time during the cooking process.

Recommended Settings

Type of Cooking	Power Level
Rapid heat up/rapid rolling boil	HIGH
Low level rolling boil	6 to 7
Frying	9 to HIGH
General cooking or browning	6 to 9
Simmer	2 to 5
Keep warm*	LOW to 1

***CAUTION:** Avoid bacteria growth, keep food above 140°F.

- Turn off power to the cooking zone by touching the **ON/OFF** key or simply remove the pan from the cooktop. 30 seconds after removing a pan the control for that cooking zone shuts off automatically. **NOTE:** If a pan is placed on the same cooking zone before 30 seconds has elapsed the cooking zone will remain on at the same setting.

Cooking Tips:

- Practice and experience will ultimately determine the power levels that work best for you. Don't be afraid to experiment and arrive at your own preferred cooking settings. You may want to take notes when you find a setting that works good for a particular food item. There is a blank table in the back of this manual to help.
- There will be some variation in the efficiency of the pots being used. All brands do not behave in exactly the same way since the different metals used conduct the electromagnetic waves from the induction elements differently.

Operating the Oven

Control Panel Settings

Setting the Clock

1. Press the **CLOCK** key. The colon between the minutes and seconds on the time display will begin to flash.
2. Enter the current time on the number keypad before the colon stops flashing. For example: For 12:08, press **1-2-0-8** on the keypad. Press the **#** key to change the AM-PM indicator.
3. Press **START • CONTINUE**.



IMPORTANT

- The clock cannot be set during delay timed cooking, if one of the timers is in use or if self clean or Sabbath mode is active.
- After a power failure, the time on the display may flash, indicating that the time may not be correct.
- After pressing the clock key, you must enter the time and press **START • CONTINUE** soon afterward. If you wait too long between pressing keys, the display will go back to the original setting.

24/12 Hour Clock (Military Time)

The oven is set to 12-hour (non-military) time at the factory. 24 hour time is also known as military time. 1:36 PM = 13:36 military time.

If you want to switch the clock to 24 hour time or switch from military back to regular time:

1. Press and hold the **CLOCK** key for six seconds. The display will indicate the mode the clock is currently set to, **12 Hr** or **24 Hr**.
2. Press the **#** key to change the clock mode. To leave the setting as is, do not touch any keys.
3. Press **CANCEL • SECURE** to return to the main display. If you have set the clock to 24 hour time, the keypad will allow you to enter military time when setting the clock.

Setting the Temperature Scale

You can select the temperature scale (Fahrenheit or Celsius) the oven uses to display the cooking temperature. The oven is preset at the factory to Fahrenheit.

To change the temperature scale:

1. Press and hold the **BROIL** key.
2. The display will indicate the temperature scale the control panel is currently set to, **"F"** or **"C"**.
3. Press the **#** key to change the temperature scale. To leave the setting as is, do not touch any keys.
4. Press **CANCEL • SECURE**. The control panel will go back to the regular clock display, set to the new temperature scale.

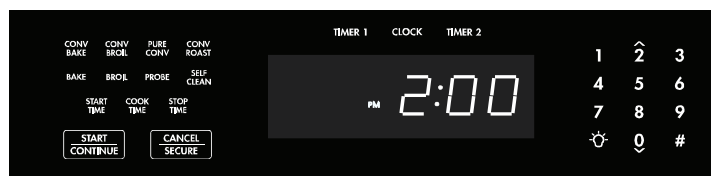

Turning the Control Panel "Beep" Off/On

The control panel beeps any time you press any of the keys or when various error conditions exist. It also beeps when a timer is done counting down (page 13) or whenever the oven performs certain preset functions, for example, pre-heat is complete. The tone may be silenced so that it does not function under the above conditions.

To turn the control panel "beep" off (or on):

1. Press and hold the **START TIME** key for six seconds, until **"beep"** appears on the display.
2. Press the **#** key repeatedly to switch between **"On"** and **"Off"**.
3. Press **CANCEL • SECURE** when the desired mode appears on the display.
4. To change the control panel back to the previous mode, repeat the above steps.

Lock-Out Feature

If you want to disable the keys on the control panel when the oven is not in use:

- Push and hold the **CANCEL • SECURE** key for about four seconds. The control panel keys will stop working and **"OFF"** will appear on the display. Only the **CANCEL • SECURE** and the oven light keys remain functional.
- To reactivate the control panel, press and hold the **CANCEL • SECURE** key for four seconds.

Before Using the Oven...

- Dacor recommends turning the oven on for one hour at 500°F to burn off any residual oils used during the manufacturing process. Any of these oils left on the inner parts can cause an undesirable smell the first few times the oven is used.
- When you use your oven to bake or roast, it preheats automatically. The preheat cycle rapidly brings the oven chamber up to the proper cooking temperature. It takes several minutes to preheat the oven. Preheat time depends on the temperature settings. The time may be longer depending on the type of electrical supply in your community. There is no preheat cycle for any of the broil modes.
- After you pull food out of the oven, it will continue to cook. This process is called "carry-over." The larger the portion of food, the longer it will cook. It is best to let the meat rest after it comes out of the oven for 10 to 15 minutes before carving. Doing so will allow the meat to retain its natural juices and make it easier to carve.

Operating the Oven

Racks

You may use either rack type on any level inside the oven.

WARNING

To reduce the chance of burns, position the oven racks when the oven is cool. If you must reposition a rack when the oven is hot, do not allow potholders to contact the heating element inside the oven.

Standard Racks

To insert a standard oven rack:

1. Insert the end of the rack with the safety notches into the oven first.
2. Attach both sides of the rack to the rack supports in the oven as shown in the diagram below.
3. Begin to slide the rack in, and then, lift up so that the safety notches clear the ends of the rack supports.
4. Push the rack all the way in with both hands.

To remove a standard oven rack:

- If you want to remove an oven rack, grasp it with both hands and pull gently straight out toward you until it stops.
- To remove the rack completely, lift the front of the rack up about six inches and continue to pull it out. Lifting the rack releases the safety notches. The safety notches reduce the chances of a rack coming out of the oven accidentally.

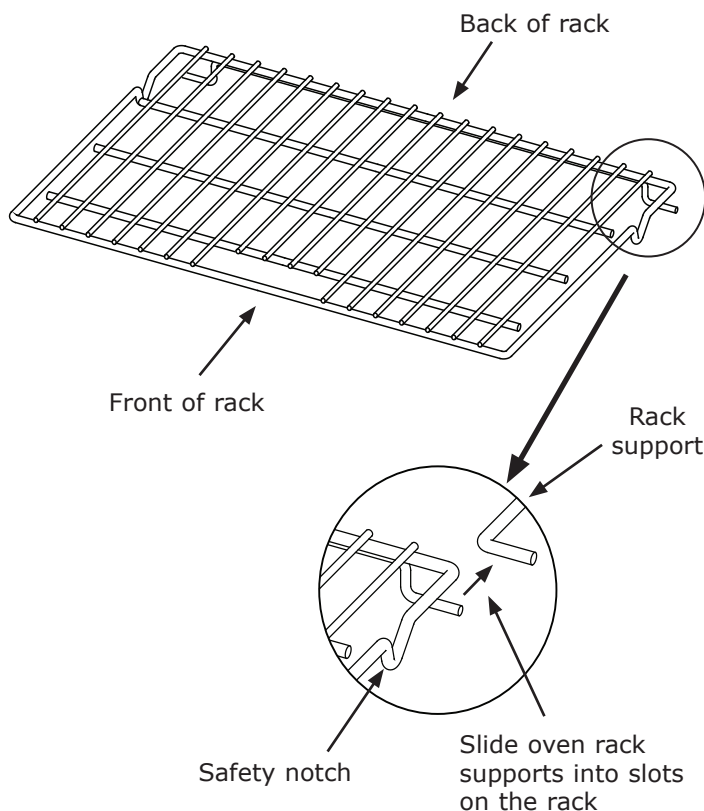

Standard Rack

GlideRack™ Oven Racks

Your oven comes with Dacor's deluxe GlideRack oven racks. You can pull them out further than other types of oven racks and still support heavy pots and pans full of food. They are great for heavier foods and the optional Dacor baking stone.

To install a GlideRack oven rack:

1. Align both sets of safety clips (right and left) on the back of the rack guides with the oven rack supports as shown below. **NOTE:** The diagram below shows installation with the rack guides extended but, the rack may be installed with or without the guides extended, whichever is easier.
2. Begin to slide the rack in, lifting the front safety clips over the front of the oven rack supports.
3. Push the rack all the way in.
4. Grasp the rack in the center of the front and pull. The rack should come forward while the guides remain in place.

To remove a GlideRack oven rack:



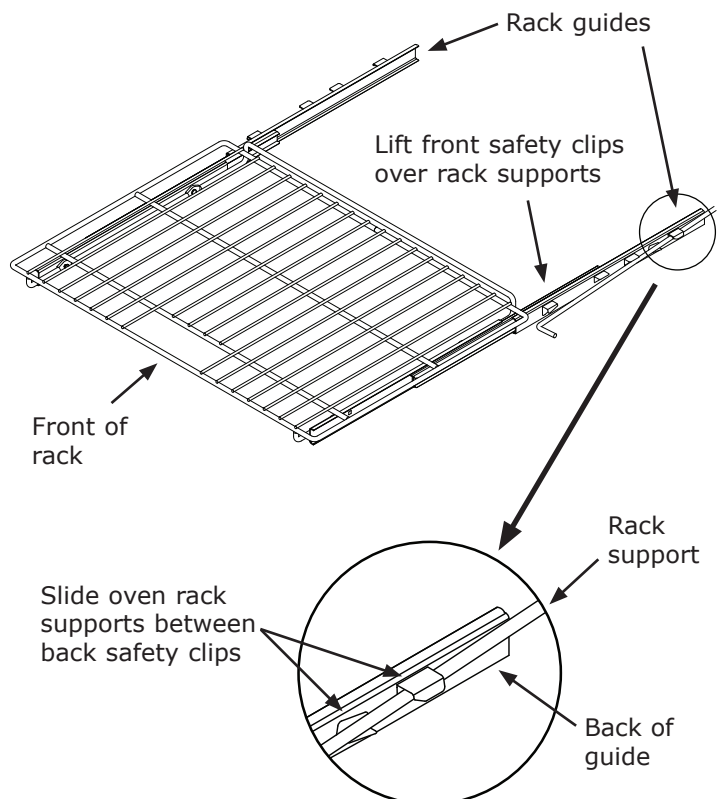



- Grasp the rack with both hands and pull it gently straight out toward you until it stops.
- Lift up until the front safety clips just clear the front of the rack supports on the oven. Continue to pull out. Moving the end of the rack back and forth slightly, left to right, as you pull, will make it easier to remove.



GlideRack Oven Rack Installation

Operating the Oven

Starting Your Oven

1. Adjust the racks to the appropriate level.
2. Determine the best cooking mode for the type of food to be cooked. Select from the following:
 - ◇ **CONVECTION BAKE** - A combination of the convection fan and a bottom heat source. Good for single rack items in a deep pan. 
 - ◇ **CONVECTION BROIL** - A combination of the convection fan and a top heat source. Good for items that do not need to be flipped, such as thinner cuts of meat, fish and garlic bread. 
 - ◇ **PURE CONVECTION™** - Uses convection cooking only for even heat. Use for baked goods and multiple rack cooking. 
 - ◇ **BAKE** - Cooks with a bottom heat source only. Commonly used for basic recipes. 
 - ◇ **BROIL** - Cooks using a top heat source alone. Use for grilling smaller cuts of meat or toasting bread. 
 - ◇ **CONVECTION ROAST** - Combines top and bottom heat sources with the convection fan. Best for rib roasts, turkeys, chickens, etc. 

See pages 11 to 13 for detailed descriptions of the various cooking modes.



IMPORTANT

The broil modes will not work when the meat probe is connected.

3. Press the key for the desired cooking mode. The preset (jump-in) temperature for that mode will appear on the display along with the symbol(s) for the selected cooking mode (see above).
4. To cook at the preset temperature, press **START**. To cook at a different temperature enter it (for example **4-2-5**) on the number keypad, then press **START**. You can enter any temperature between 100°F and 555°F. The suggested broil temperature is 555°F.
5. If you are using Pure Convection or one of the bake or roast modes, "**PRE-**" for preheating, along with the current oven temperature will appear on the display until the oven reaches the set temperature. Once the oven reaches the set temperature (usually in 10 minutes), it will beep and "**PRE-**" will disappear. Carefully place your food in the oven. Excessive browning will occur if you put the food in too soon.

Turning Off Your Oven

To turn the oven off, press the **CANCEL • SECURE** key.



NOTE

After you turn off the oven, the cooling fans may continue to run until the range's internal parts have cooled down.

Changing the Temperature

(after you press **START • CONTINUE**)

1. Press the key for the current cooking mode. The current cooking mode appears on the display (for example **BAKE**).
2. Enter the temperature on the keypad (for example **3-7-5**) and press **START • CONTINUE**.

Changing the Oven Cooking Mode

(after you press **START • CONTINUE**)

To change to a different cooking mode while the oven is on, for example to change from convection bake to bake:

1. Press the key for the new cooking mode, for example **BAKE**.
2. Press **START • CONTINUE**.

Preset (Jump-in) Temperature Settings

Below is a list of the jump-in temperatures for the various cooking modes (see step 3 of the **Starting Your Oven** section on this page). This feature reduces the need to always enter the temperature when starting your oven.

Cooking Mode	Preset Temperature
Bake	350°F
Convection bake	325°F
Pure Convection	325°F
Convection roast	375°F
Broil	555°F
Convection broil	555°F

12 Hour Timer Feature

The oven's 12 hour timer feature automatically turns it off after 12 hours of continuous use. The 12 hour timer resets if you change the cooking temperature or cooking mode. This feature does not apply to the cooktop.

The range ships from the factory with this feature enabled.

To disable or enable the 12 hour timer feature:

- With the oven off, push and hold the **TIMER 1** key for about ten seconds, until the control panel beeps. "**ON**" will appear on the display if the 12 hour timer is enabled.
- Push the **SELF CLEAN** key to disable (or enable) the 12 hour timer.
- Push **START • CONTINUE** to save the changes and return to the clock display.

Operating the Oven

Understanding the Various Oven Cooking Modes

The three basic styles of cooking in an oven:

- **BAKING** - The gentle cooking of dry goods such as cookies, cakes, soufflés, etc.
- **ROASTING** - The cooking of meats or vegetables over a period of time.
- **BROILING** - Cooking with an intense heat for a short amount of time.

Bake

Uses only a heat source from below the food. This mode is the stand-by, non-convection mode. All baked items will turn out nicely in this mode.

Baking Tips

- For best results, use a single rack in the lowest position when using bake mode. For cooking on multiple racks, Dacor recommends using one of the convection modes. See the following pages.
- Follow your recipe's original cooking time and temperature.
- Do not open the oven door frequently during baking. Look through the oven door window to check the progress of baking whenever possible.
- Use the timers to determine baking time.
- Wait until the shortest recommended baking time before checking the food. For most baked goods, a wooden toothpick placed in the center should come clean when the food is done.

Your range offers three convection cooking modes:

- **Convection Bake**
- **Convection Roast**
- **Pure Convection**

As a general rule, in the convection modes, the cooking time is about 25% shorter. Set the timer 15 minutes before the shortest stated time and add more time if necessary.

For Pure Convection and Convection Bake Modes:

Some recipes, especially those that are homemade, may require adjustment and testing when converting from standard to convection baking. If you are unsure how to convert a recipe, begin by preparing the recipe using the standard bake settings. After achieving acceptable results in standard bake mode, adjust the convection cooking times according to the guidelines above. If the food is not cooked to your satisfaction during this first convection trial, adjust one recipe variable at a time (such as cooking time, rack position, or temperature) and repeat the convection test. If necessary, continue adjusting one recipe variable at a time until you get satisfactory results.

Convection Bake

Use this mode for single rack baking. The combination of the convection fan and bottom heat source is best for fruit crisps, custard pies, double-crust fruit pies, quiches, yeast breads in a loaf pan and popovers. Also, items baked in a deep ceramic dish or earthenware clay pots are best in this mode. Most of these items cook in a deep pan and require browning on the top and bottom.

Common Problems When Using Standard Bake Mode

Problem	May Be Caused By	What to Do
Cookies burn on the bottom.	Oven door opened too often.	Set timer to shortest recommended cooking time and check food when timer beeps. Use door window to check food.
	Incorrect rack position used.	Change rack position.
	Dark, heat absorbing cookie sheets used.	Use shiny, reflective cookie sheets.
Cookies are too brown on top.	Rack position being used is too high.	Change rack position.
	Food placed in oven during pre-heat.	Wait until oven is preheated.
Cakes burn on the sides or are not done in the center.	Oven temperature too high.	Reduce oven temperature.
	Dark, heat absorbing cake pans used.	Use shiny, reflective cake pans.
Cakes crack on top.	Oven temperature too high.	Reduce oven temperature.
Cakes are not level.	Oven and/or oven rack not level.	Level oven and rack as needed.
Pies burn around the edges or are not done in the center.	Oven temperature too high.	Reduce oven temperature.
	Dark, heat absorbing pans used.	Use shiny, reflective pans.
	Oven and/or rack over-crowded.	Reduce number of pans.

Operating the Oven

Understanding the Various Oven Cooking Modes (cont.)

Pure Convection

The uniform air circulation provided by Pure Convection allows you to use more oven capacity at once. Use this mode for single rack baking, multiple rack baking, roasting, and preparation of complete meals. Many foods, such as pizzas, cakes, cookies, biscuits, muffins, rolls and frozen convenience foods can be successfully prepared on two or three racks at a time. Pure Convection is also good for whole roasted duck, lamb shoulder and short leg of lamb.

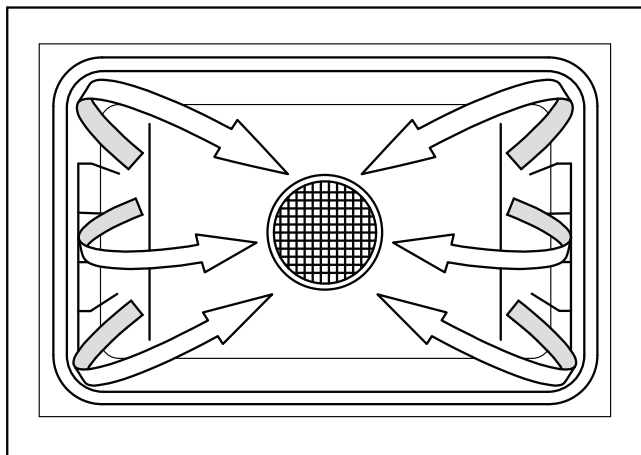

Multiple Rack Baking in Pure Convection Mode

- Typically, when baking on two racks, use rack positions #1 and #3 or #2 and #4 (counting from the bottom up) for best results. When cooking a full meal, use rack positions #1, #3 and #5 for best results.
- When adapting a single rack recipe to multiple rack baking, it may be necessary to add to the baking time due to the extra bulk of the food in the oven.

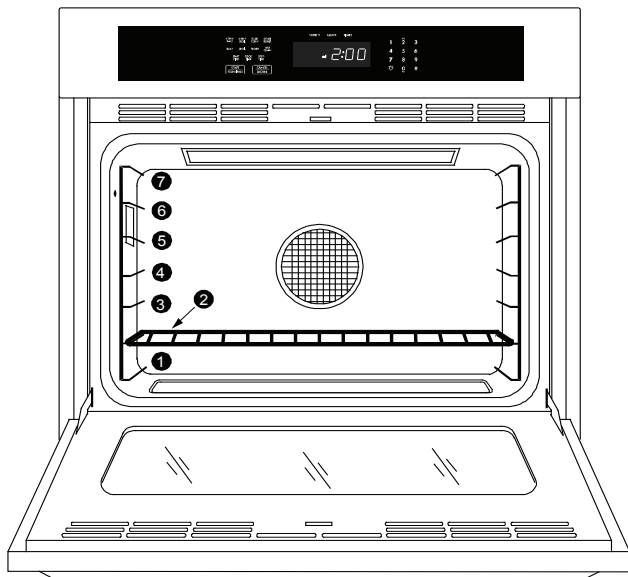

Convection Roast

Your range's convection roast mode uses a combination of the convection fan and heat sources above and below the food. It is best for rib roasts, turkeys, chickens, etc.

Roasting Tips

- All baking modes can be used to successfully roast in your oven. However, the convection roast mode is recommended to produce meats that are deliciously seared on the outside and succulently juicy on the inside in record time. Foods that are exceptional, when prepared in the convection roast mode, include: beef, pork, ham, lamb, turkey, chicken and cornish hens.
- Always roast meats fat side up in a shallow pan, using a roasting rack. Always use a pan that fits the size of the food being prepared. No basting is required when the fat side is up. Do not add water to the pan. It will cause a steamed effect. Roasting is a dry heat process.
- Poultry should be placed breast side up on a rack in a shallow pan that fits the size of the food.
- When using the roast mode, do not use pans with tall sides. They interfere with the circulation of heated air over the food.
- If using a meat thermometer, insert the probe halfway into the center of the thickest portion of the meat. For poultry, insert the thermometer probe between the body and leg into the thickest part of the inner thigh. To ensure an accurate reading, the tip of the probe should not touch bone, fat or gristle. Check the meat temperature $\frac{2}{3}$ of the way through the recommended roasting time. After reading the meat thermometer once, insert it $\frac{1}{2}$ inch further into the meat, then take a second reading. If the second temperature registers below the first, continue cooking the meat.
- Remove meats from the oven when the thermometer registers 5 to 10°F below the desired temperature. The meat will continue to carry-over.
- Allow roasts to stand 15 to 20 minutes after roasting in order to make carving easier.
- Roasting times always vary according to the size, shape and quality of meats and poultry. Less tender cuts of meat are best prepared in bake mode and may require moist cooking techniques. Follow your favorite cookbook recipes.
- Reduce spatter by lining the bottom of the roasting pan with lightly crushed aluminum foil.

Operating the Oven

Your range offers two broil modes:

- **Broil**
- **Convection Broil**

Broiling is a quick and flavorful way to prepare many foods, including steaks, chicken, chops, hamburgers and fish.

WARNING

- To avoid burns, keep the oven door completely shut when using the broil modes.
- To avoid damage to the meat probe, remove it from the oven when using either of the broil modes.

Broil

This mode uses a top heat source. It is best for broiling smaller amounts of food.

Convection Broil

This mode uses a combination of the convection fan and a top heat source. It is best for items that do not need to be flipped such as thinner cuts of meat, fish and garlic bread.

Broiling Tips

- It is normal and necessary for some smoke to be present to give the food a broiled flavor.
- Setting the timer is recommended to time the broiling process.
- Always use a broiler pan and grill to provide drainage for excess fat and grease. Doing so will reduce splatter, smoke and flare-ups.
- Start with a room temperature broiler pan for even cooking.
- Use tongs or a spatula to turn and remove meats. Never pierce meat with a fork because the natural juices will escape.
- Broil food on the first side for a little more than half of the recommended time, then season and turn. Season the second side just before removing the food from the oven.
- To prevent sticking, lightly grease the broiler grill. Excess grease will result in heavy smoke. For easier cleaning, remove the broiler pan and grill when the food is removed.

Timers

WARNING

The timers on your range do not turn the oven on or off. They are only for timing purposes. When you want to turn the oven off automatically, use the **Delay Timed Cooking Features**.

IMPORTANT

Pressing the **CANCEL · SECURE** key does NOT turn off the timers.

- Your range is equipped with 2 built-in timers
- You can use both of them at the same time.
- You can time from 1 minute up to 99 hours and 59 minutes.

To use the timers on your range:

- Press the **TIMER 1** or **TIMER 2** key.
- Enter the hours and minutes to be timed on the keypad and press **START · CONTINUE**. To enter 11 hours, 30 minutes, press **1-1-3-0**. To time 25 minutes, press **2-5**. When you press **START · CONTINUE**, the time will appear on the display and begin to count down. 

When the timer is done counting down, **0:00** will appear on the display. The timer number will flash on the display and the alarm (a beeping sound) will sound. The alarms for Timer 1 and Timer 2 have different patterns.

Timer	Alarm Pattern
1	1 second on, 1 second off, repeat
2	1 second on, 1 second off, 2 seconds on, 1 second off, repeat

Press the **TIMER 1** (or **TIMER 2**) key to stop the alarm.

While a timer is running you can:

- Press **CLOCK** to view the current time.
- Press **TIMER 1** to view the time left on (or set) **TIMER 1**.
- Press **TIMER 2** to view the time left on (or set) **TIMER 2**.

To change the amount of time on a timer:

1. Press the **TIMER 1** or **TIMER 2** key.
2. Enter the new time on the number keypad and press **START**.

To stop a timer before time runs out:

- Press the **TIMER 1** or **TIMER 2** key twice. The timer will stop and the display will clear.
- Press the **CLOCK** key to return to the main display.

Operating the Oven

Delay Timed Cooking Features

If you want to set the oven to automatically turn itself on or off at a later time, you can use the delay timed features.



WARNING

Food safety is an important consideration when using the delay timed features. To avoid potential sickness and the spoiling of food, take the following steps:

- Avoid using foods that will spoil while waiting for the oven to start cooking. Typical foods to avoid include those containing eggs and dairy products, cream soups and cooked or uncooked meats, poultry and fish.
- Do not allow foods to remain in the oven after it turns completely off (after hold mode). When the temperature drops below 140°F, bacteria can develop.
- If cooking will not begin immediately, place only very cold or frozen food into the oven. Most unfrozen foods should never stand in the oven for more than two hours before cooking begins.

Things to Know About Delay Timed Cooking

- The delay timed options work for all of the various cook modes, except broil and convection broil.
- You may use the timers while using the delay timed features. The timers do not have an effect on any of the delay timed cooking options.
- The delay timed cycle can be canceled at any time by pushing **CANCEL · SECURE**.

The three delay timed cooking keys are:

- **START TIME:** The time the oven starts cooking.
- **COOK TIME:** The amount of time the oven cooks before it goes into hold mode (see facing page for description).
- **STOP TIME:** The clock time the oven turns off and goes into hold mode.

When you set 2 of the 3 above, the oven automatically calculates the third.

Ways to Use Delayed Timed Cooking

- Set the time the oven turns on (**START TIME**) and set it to turn off at a later time using either the **COOK TIME** key or the **STOP TIME** key.
- Set the **START TIME** only, then turn the oven off manually when you are done cooking.
- Turn the oven on manually and set it to turn off at a later time using either the **COOK TIME** key or the **STOP TIME** key.

How to Use Delay Timed Cooking



NOTE

Delay-timed cooking cannot be used in Sabbath mode.

1. Adjust the racks to the appropriate level.
2. Put the food in the oven.
3. Press the key for the desired cooking mode (except broil or convection broil).
4. Enter the desired cooking temperature on the number keypad.
5. If you want to turn the oven on immediately and turn off automatically at a later time, skip to step 8.
6. Press the **START TIME** key.
7. Enter the time you want the oven to start on the keypad. For 12:35, press **1-2-3-5**. You may enter a time up to 22 hours and 59 minutes ahead of the present time. Press the **#** key to change "AM" or "PM."
8. If you want to set the stop time or cooking duration, press either the **STOP TIME** or **COOK TIME** key (otherwise skip to step 9.) Using the **COOK TIME** key allows you to determine when the oven will stop cooking by entering the amount of time the oven is on. Using the **STOP TIME** key allows you to determine when the oven will stop cooking by entering the clock time. Using either key achieves the same result.
9. Press **START · CONTINUE**.
10. If you entered a **START TIME**, the oven will start at the start time entered.
11. If you entered a **COOK TIME** or **STOP TIME** the oven will cook until the time entered and then, go into hold mode.



IMPORTANT

The time required to preheat the oven must be included in the cook time. For cooking temperatures 350°F and below, add 20 minutes to the cook time. Increase the cook time as the temperature increases above 350°F.

About Hold Mode

- When you set the oven to stop cooking using the **COOK TIME** or **STOP TIME** keys, it will go into hold mode ("Hld" appears on the display) when it reaches the end of the cook time you have set. The oven will keep the temperature at 150°F for two hours.
- Press **CANCEL · SECURE** to turn the oven all the way off.
- To prevent sickness, do not allow foods to remain in the oven after it is off (after hold mode turns off).

Operating the Oven

Other Things to Know About Delayed Timed Cooking

When the oven is in delay timed mode:

- Push the **CLOCK** key to view the clock (current time).
- Push the **START TIME** key to view the current start time setting.
- Push the **STOP TIME** key to view the current cook time setting.
- Push the **COOK TIME** key to view the current cook time setting.

Sabbath Mode

The Sabbath mode on your oven complies with Jewish laws for use on the Sabbath and Holy Days. This feature allows the oven to perform two types of cooking, bake and Pure Convection.

When the oven is set to Sabbath mode, it disables the following features:

- The oven light
- All keys, except **CANCEL · SECURE**, **START · CONTINUE** and the **0** and **2** keys on the number keypad.



NOTE

- **"Sab"** appears on the display when Sabbath mode is in operation.
- As with all other cooking modes, when setting the control panel for Sabbath operation all keys must be pressed within six seconds of each other. Otherwise the control panel will automatically clear.
- The cooktop controls are NOT disabled when the oven is in Sabbath mode.
- Sabbath mode will not work with the meat probe connected (the meat probe symbol will flash).
- Delay-timed cooking cannot be used in Sabbath mode.
- In the event of a power outage, the oven will return to Sabbath mode at the temperature it was last set to when power is restored.
- If one or both timers are running, the oven cancels timer operation when Sabbath mode is selected. The 12 hour timer is also disabled in Sabbath mode.
- You may want to use a rack thermometer to keep track of the oven temperature.

Setting Up the Sabbath Feature

1. Press the **#** key.
2. Press the **BAKE** or **PURE CONV** key.
3. Press the **0** or **2** keys repeatedly if you want to change the pre-selected cooking temperature shown on the display.
4. Press (only) the **START · CONTINUE** key. The oven will go into Sabbath mode and cook using the mode selected in step 2.

Things to Know About Sabbath Mode

- The **CANCEL · SECURE** key on your oven remains active so that you can turn off the Sabbath feature or turn off the oven.
- When the oven is cooking, pressing the **2** key on the number keypad, then **START · CONTINUE**, tells the oven to raise the temperature by 25°F (15°C). Pressing the **0** key on the number keypad, then **START · CONTINUE**, tells the oven to lower the temperature by 25°F (15°C). In compliance with Jewish law, the heating element will be adjusted randomly when these keys are pressed and no changes will be seen on the display.

Please visit www.star-k.org for further information about Sabbath compliance and usage of this product.

Operating the Oven

Using the Meat Probe

When you cook foods like roasts and poultry, the internal temperature is the best way to tell when the food is properly cooked. Your oven's meat probe is an easy way to take the guesswork out of roasting. You can use it to cook food to the exact temperature you desire. The probe can be set from 100°F to 200°F.

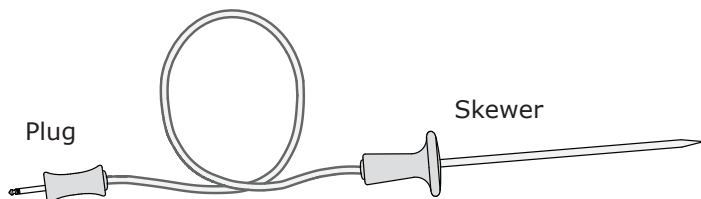

WARNING

- To avoid the possibility of burns, use hot pads to handle, connect, and unplug the meat probe when the oven is hot.
- Use the handles to insert and remove the meat probe's skewer and to connect it to the oven. Pushing or pulling on either end of the cable could damage the meat probe. To avoid breaking the meat probe, make sure the food is completely defrosted before inserting the skewer.
- To prevent damage, never leave the meat probe inside the oven when it is not being used, especially when broiling or during the self clean cycle.
- Using a meat probe other than the one provided with your oven may result in damage to the probe and/or the oven.

NOTE

- The meat probe does not work with broil, convection broil or Sabbath modes. If you plug in the meat probe when using the above modes, the meat probe symbol will flash indicating an error.
- If the meat probe is accidentally disconnected after the **PROBE** key is pressed, the meat probe symbol will flash and the error message "OPn" will appear on the display.

Meat Probe Instructions

1. Prepare the meat for cooking prior to setting the oven. Insert the meat probe skewer into the center of the meat. Make sure that the skewer is not inside any fatty portions of the meat and does not touch any bones. The point should rest in the thickest part of the meat. When you are cooking fowl, the tip of the skewer should rest toward the center of the bird.
2. Before placing the meat in the oven and with the door closed, push the **BAKE, CONV BAKE, PURE CONV** or **CONV ROAST** key. The preset temperature will appear on the display. If you want to cook using a different oven temperature, enter it on the number keypad.
3. Press **START • CONTINUE**.

4. Allow the oven to preheat. Excessive browning may occur if the meat is placed in the oven during preheat mode (when "**PRE-**" appears on the display).
5. Once the oven has preheated ("**PRE-**" disappears), put the meat in the oven using potholders. Insert the meat probe plug into the connector inside the oven.
6. Push the **PROBE** key. The preset probe temperature (160°F), as well as the probe symbol, will appear on the display. If you want to cook using a different probe temperature, enter it on the keypad. Use the **USDA Minimum Safe Cooking Temperature Chart** on the next page as a guideline for the type of meat you are cooking.
7. Press **START • CONTINUE**. If you do not press **START • CONTINUE**, the probe mode will not start.



When the meat probe is in use, the oven will automatically control the cooking time. The temperature on the display during cooking is the temperature measured inside the meat. The oven will continue to cook until the meat temperature reaches the temperature you have entered. When the meat is done, the oven will go into hold mode. The temperature will reduce to 150°F for two hours to keep the meat warm and safe for serving. To prevent sickness, do not allow foods to remain in the oven after it has turned off. Press **CANCEL • SECURE** to cancel hold mode and turn the oven completely off.

To change the meat probe temperature during cooking:

1. Press **PROBE**. The current probe temperature setting will appear on the display.
2. Enter the new temperature. The oven will automatically change to the new probe temperature. If you do not enter a temperature, the oven will continue to cook at the current setting.

To change the cooking mode during meat probe cooking:

1. Press the **CANCEL • SECURE** key.
2. Press the **BAKE, CONV BAKE, PURE CONV** or **CONV ROAST** key. If you want to cook using a temperature different than the oven's preset temperature, enter it on the number keypad.
3. Press **START • CONTINUE**.

To cancel meat probe operation while the oven is cooking:

Press the **PROBE** key twice. Disconnect the meat probe from the connector and remove it from the oven. The oven will return to any previous settings that were entered before the **PROBE** key was pressed.

Operating the Oven

Important Details About Meat Probe Use

- You must select the specific cooking mode (**BAKE**, **CONV BAKE**, **PURE CONV** or **CONV ROAST**) before you press the **PROBE** key.
- When you press the **PROBE** key the preheat cycle is disabled and the amount of time required to heat the oven is extended. For best results, select the cooking mode and allow the oven to preheat prior to pressing the **PROBE** key and putting the meat in the oven.
- The meat probe function will automatically cancel after 30 seconds if the meat probe is not connected. The meat probe symbol will flash on the display.
- The meat probe feature takes precedence over the delay timed cooking feature. The oven will continue to cook the meat until it reaches the selected meat probe temperature regardless of the **STOP TIME** or **COOK TIME** setting, then go into hold mode.

USDA Minimum Safe Internal Cooking Temperatures for Various Foods

GROUND MEAT AND MEAT MIXTURES	
Beef, pork veal, lamb	160°F
Turkey, chicken	165°F
FRESH BEEF, VEAL, AND LAMB	
Medium rare	145°F
Medium	165°F
Well Done	170°F
POULTRY	
Chicken/turkey, whole (temp taken in thigh)	180°F
Poultry breasts, roast	170°F
Poultry thighs, wings, legs	180°F
Duck and goose	180°F
Stuffing	165°F
FRESH PORK	
Medium	160°F
Well done	170°F
HAM	
Fresh (raw)	160°F
Pre-cooked (reheat)	140°F



NOTE

The minimum safe internal cooking temperatures are subject to change. There are changes in bacteria and the temperatures required to eradicate them. For the most current information, contact the USDA.

USDA Meat and Poultry Hotline:

Phone: (800) 535-4355
www.fsis.usda.gov

Dehydrating/Defrosting

Your range can be used to dehydrate or defrost foods at low heat settings in the Pure Convection mode.



WARNING

To avoid food poisoning, cook meats immediately after defrosting them.

To dehydrate or defrost foods:

- Adjust the racks to the appropriate level.
- Place the food on the center of the oven rack. If you are dehydrating, prepare food as recommended, then place it on a drying rack.
- Press the **PURE CONV** key.
- To defrost meats, enter the temperature, up to 150°F, on the number keypad. To dehydrate, start with the temperature setting below. When dehydrating, you may need to experiment with higher temperatures.
- Press **START • CONTINUE**.

Food Type	Dehydrating Temperature
Fruit	100°F
Vegetables	125°F
Meat	150°F

Dacor recommends that you use one of the timers to time the process.

Dehydrating Tips

Equipment Recommended

- Half sheet pan or jelly roll pan with ½" rim all the way around
- Baking rack that fits inside the half sheet pan
- Cheesecloth
- 4 quart sauce pot with lid
- Steamer basket that fits inside 4 quart saucepan. One that is perforated and opens up will work well.
- Slotted spoon
- Paper towels
- A sharp knife

When you dehydrate:

- Wash and remove excess moisture from all fruits and vegetables before dehydrating.
- Cut fruits and vegetables into uniform pieces.
- You can add honey, spices, lime juice or orange juice to give the fruit a different flavor.
- It is best to dehydrate on a baking rack with a pan underneath to catch any juices. If using a rack when dehydrating small fruit, put cheesecloth over the rack to allow for maximum air circulation and to prevent the fruit from sticking to the rack.
- Place the food onto the center of the oven rack.

Operating the Oven

Dehydrating/Defrosting (cont.)

Solving Discoloration Problems

To prevent darkening during dehydration and storage, you should steam blanch apples, apricots, peaches, nectarines, pears or foods that will oxidize.

To steam blanch:

1. Add one inch of water to a four quart sauce pot. Insert the steam basket and place the fruit in it.
2. Cover the pot and steam for one to two minutes.
3. Remove with a slotted spoon and dab with a paper towel to remove excess moisture before dehydrating.
4. Apples, pears, pineapples and some other fruits will brown or darken during dehydration. To prevent discoloration, dip fruits in pineapple juice or lemon juice after steam blanching.

Creating a Candied Effect

To give fruit a candied effect and to help retain color, blanch them in a simple syrup. You can candy the fruits mentioned above as well as figs and plums. The basic ratio for a simple syrup is one cup of sugar to one cup of water. Add these ingredients to a four quart stock pot and bring to a boil. Stir until all the sugar dissolves. Remove the saucepan from the cooktop and allow it to cool. Dip fruit into the simple syrup after it has cooled.

Preventing Tough Skins When Dehydrating

You should water blanch items with tough skins such as grapes, prunes, dark plums, cherries, figs and some types of berries. Water blanching these types of fruit will crack the skins so that moisture can escape and dehydration can be done more effectively.

To water blanch:

1. Bring two quarts of water to boil in a four quart sauce pot.
2. Drop the fruit in the water for one to two minutes, or until the skin begins to crack.
3. Remove the fruit with a slotted spoon and dab dry with a paper towel before dehydrating. The pit can be left inside or removed half way through the dehydrating process.

Defrosting Tips

- Food that takes an exceptional amount of time to defrost will not defrost well in a convection oven.
- You should not defrost anything that would normally take over two hours to thaw. The food will begin to spoil because the defrost temperature is not high enough to cook the food.
- If you have a partially defrosted turkey, rib roast or other large cut of meat, you may continue to defrost it in your convection oven. If wing tips and legs begin to dry out when you defrost poultry, you may wrap the tips with aluminum foil.
- If you are defrosting a small cut of meat, lay it on a flat cookie sheet with a one inch rim to catch juices as the meat thaws.

- Thick, frozen casseroles such as lasagna will not defrost well in your oven. Instead, defrost according to the food manufacturer's suggestions. You may also defrost casseroles in the refrigerator overnight. You should leave the food in its original container and keep it covered.
- You can bake some foods from frozen. Some examples are: pizza, frozen pastries, croissants, cookies, etc. Before baking frozen food, preheat the oven.

Proofing

You can use your range to proof yeasted doughs at a low and draft-free temperature using the bake mode.

1. Press the **BAKE** key.
2. Enter the temperature of 100°F on the keypad.
3. Press **START • CONTINUE**.
4. Place the dough in a greased bowl inside of the oven. Cover it with either a damp cloth or plastic wrap coated with a nonstick spray.
5. Turn on the oven light.
6. Set the timer for the amount of rise time in the recipe.

Adjusting the Oven Temperature

Even though your oven is adjusted at the factory to cook at the temperature shown on the display, it may cook faster or slower than your old oven.

WARNING

Do not adjust the probe or self clean offset temperatures. The offset for the probe and self clean offsets must remain at 0 for proper and/or safe operation.

IMPORTANT: Do not measure the temperature inside the oven with a thermometer. Opening the door will cause an incorrect reading. Also, the temperature inside the oven will vary as the elements cycle on and off.

If you are not satisfied with the results from your oven, you can adjust the temperature offset as follows:

1. With the oven off, press and hold the **0** and **#** keys on the number keypad at the same time. After about three seconds "**PASS**" will appear on the display.
2. Immediately enter **6428** on the number keypad, then **START**. "**SLCT**" (select) will appear on the display.
3. Press the key for the cooking mode you want to change the offset for (**CONV BAKE**, **CONV BROIL**, **PURE CONV**, **CONV ROAST**, **BAKE** or **BROIL**).
4. Enter an offset temperature value from 1 to 35°F (1 to 18 for ovens set to Celsius). Press the **#** key after entering the numeric value if you want the offset to be a negative (-) value. Press **#** again to toggle the (-) setting off. "**Edit**" appears on the display when you start to enter the offset value.
5. Press **START • CONTINUE** to save the setting.
6. Repeat steps 3 to 5 to offset other cooking modes.
7. Press **CANCEL • SECURE** to exit offset mode.

Cooking Tips

Food Placement

NOTE: The rack positions mentioned below are counting from the bottom up.

- For best results when baking on two racks, use rack positions #2 and #4 or #1 and #3 with the oven set to Pure Convection or convection bake mode. For best results when baking on three racks, use rack positions #1, #3 and #5 with the oven set to Pure Convection mode.
- Turn pans on the racks so that the long sides run left to right, as you face them.
- Your Dacor GliderRack oven racks are good for cooking heavy food items. You can pull them out further than standard racks, making it easier to check the food, stir or add ingredients.
- Heavier roasting pans and dishes will cook better on rack position #1.
- When using the optional Dacor baking stone, use rack position #1 for best results.

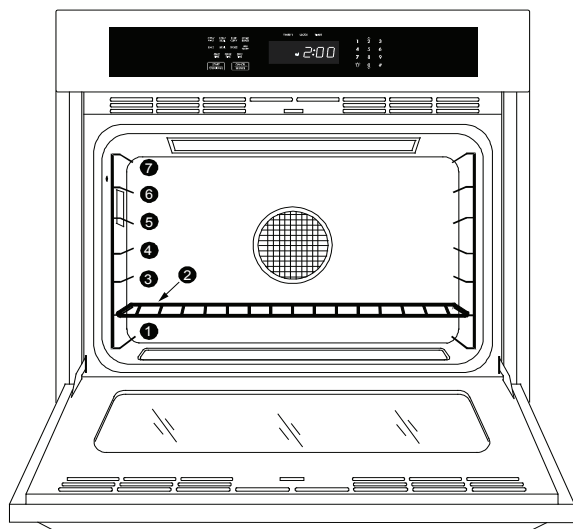

Oven Rack Positions

The Best Use of Bake Ware

- You should bake cakes, quick breads, muffins and cookies in shiny, reflective pans for light, golden crusts. Avoid old, darkened, warped, dented, stainless steel and tin-coated pans. They heat unevenly and will not give good baking results.
- Use medium gauge aluminum sheets with low sides when preparing cookies, biscuits and cream puffs. Dacor cookie sheets, with their low profiles, will give you the best results.
- Bake most frozen foods in their original foil containers, placed flat on a cookie sheet. Follow the package recommendations. When using glass bake ware, reduce the recipe temperature by 25°F, except when baking pies or yeast breads. Follow the standard recipe baking time for pies and yeast breads.
- Use the pan size and type recommended by the recipe for best results.

- For roasting, Dacor's optional "V" shaped rack and broil/roast pan works best to allow air circulation around the food. Dacor's roasting pan works particularly well and two of them will fit side by side in a 30-inch oven. The kit also comes with a grill that fits inside the pan to cook flat cuts of meat.

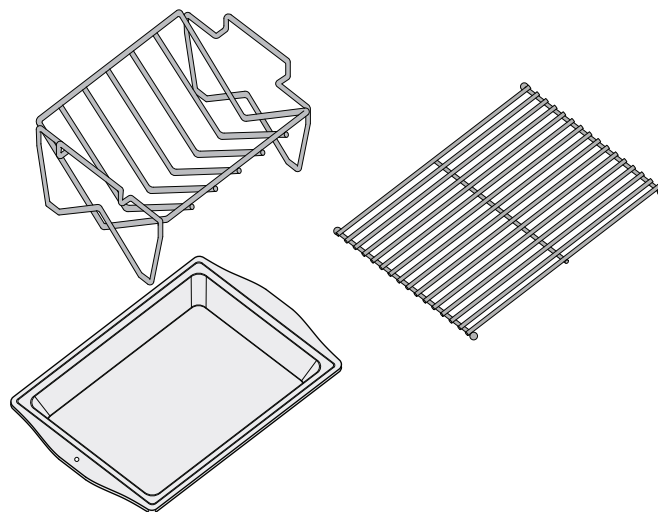

High Altitude Cooking

Due to the lower atmospheric pressure at higher altitudes, foods tend to take longer to cook. Therefore, recipe adjustments should be made in some cases. In general, no recipe adjustment is necessary for yeast-risen baked goods, although allowing the dough or batter to rise twice before the final pan rising develops a better flavor. Try making the adjustments below for successful recipes. Take note of the changes that work best and mark your recipes accordingly. You may also consult a cookbook on high altitude cooking for specific recommendations.

Altitude (feet)	Baking Powder for each teaspoon decrease by:	Sugar for each teaspoon decrease by:	Liquid, for each cup add:
3000	5-10%	10-25%	5-10%
5000	10%	10%	20%
7000	25%	20%	20-25%

Care and Cleaning

WARNING

- Clean only the parts of the range listed in this manual. Clean them only in the manner specified.
- To avoid dangerous fumes or damage to your range's surfaces and accessories, use only the types of cleaning solutions specified in this manual. Some cleaners can produce noxious fumes if applied to a hot surface.
- Clean the cooktop with caution. If a wet sponge or cloth is used to wipe up spills on a hot cooktop, be careful to avoid steam burns.
- To prevent damage, do not use abrasive or corrosive cleaners or applicators such as steel wool or scouring pads, on any part of the range unless instructed to do so. Use only a sponge, soft cloth, fibrous or plastic brush or nylon cleaning pad for cleaning the surfaces of your range.
- Do not use a steam cleaner to clean the range. Steam could penetrate the electrical components and cause a short circuit.
- Do not try to remove heavy spills with a sharp object such as a knife or metal spatula. Sharp objects may scratch your range's surfaces.
- Always wipe up excess grease and other food spills with a damp cloth prior to using the self clean cycle. Doing so will minimize smoke and increase efficiency. See the proper cleaning instructions on this page.
- Do not touch the outside surfaces of the oven during the self clean cycle. They will be hot.
- The racks, the convection filter, the meat probe or any other items left in the oven during self cleaning will become damaged or damage the oven.
- Use caution when cleaning the door gasket. Rubbing or displacing it may damage the tight door seal required for proper cooking and self cleaning.
- During self cleaning, do not try to force the door open after it is locked to prevent damage.
- Ensure that the anti-tip bracket is engaged after the range is moved out for cleaning. Use a flashlight to look underneath the range and verify that the anti-tip bracket covers the rear leg when the range is moved back into place.

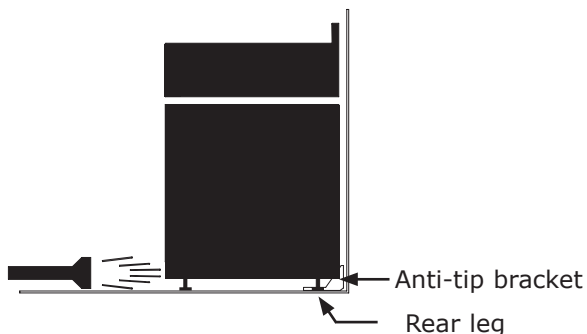

Your Oven's Self Clean Feature

About the Self Clean Cycle

- The oven will run better and produce better baked goods when it is clean. During self cleaning, the oven is heated to very high temperatures which burn off any deposits on the surfaces of the oven. Self cleaning eliminates the need for manual scrubbing of interior surfaces. The self clean process takes about three hours.
- It is normal for the oven to emit smoke during the first few self clean cycles. It is also normal for the oven to emit popping sounds during self cleaning. These sounds are caused by the expansion and contraction of metal surfaces when the oven heats up and cools down.
- Self clean mode will not function if the meat probe is connected.
- Cooktop operation is not recommended when the self-clean feature is in use.

How to Use the Self Clean Feature

1. Before self cleaning the oven, remove the racks, the convection filter, all cookware (pots, pans, forks, etc.), the meat probe, foil and any other loose objects from the oven chamber. See page 23 for instructions on how to remove and clean the filter.
2. Clean soil from the porcelain surfaces of the door outside of the door gasket. Rinse surfaces well with a solution of vinegar and water, then wipe dry. Heavily soiled areas may be cleaned with a non-scratching scouring pad.
3. Clean the door gasket by dabbing it with a solution of water and mild soap.
4. Turn on kitchen fans or vents to help remove odors during the self clean cycle.
5. Make sure the oven door is shut.
6. Press the **SELF CLEAN** key, then press **START • CONTINUE**.

The control panel automatically locks the oven door during self cleaning. The latch prevents the door from being opened since the high interior oven temperatures can easily cause injury. If the door is not shut, an error message will appear on the display. To correct the problem, press **CANCEL • SECURE** and wait approximately one minute, then close the door. When the door is properly closed, start the self clean process again.

The display shows the self clean cycle status:

- The clean symbol indicates that self clean is in process.
- The lock symbol indicates that the door is latched.
- **"ON"** indicates that the heating elements are on.

If you want to stop the self clean cycle, press the **CANCEL • SECURE** key. The oven door will remain locked until it is safe enough to open. The lock symbol will disappear from the display when the door lock is released. You will still need to exercise caution when the door lock is released because the inside of the oven may still be hot.



Care and Cleaning

After the self clean cycle is complete:

- The door latch will release when the inside has cooled down. The clean icon, lock icon and "ON" will disappear from the display. Exercise caution because the oven will still be hot (about 400°F) at the time the door lock is released.
- Reinstall the convection filter and oven racks before using your oven.
- You may notice a powder ash residue in the bottom of the oven after self cleaning. This is normal. Use a damp cloth or sponge to wipe up the residue after the oven cools down.

Self Cleaning Tips

- If any soil remains in the oven after the self clean cycle is done, you may repeat the cycle if you want.
- Self clean the oven regularly to prevent excessive soil build-up. Doing so will make the self clean cycle work better and reduce smoke and odors.

Setting the Oven to Self Clean at a Later Time

1. Prepare the oven for self cleaning as instructed on page 20. Observe all safety precautions and remove all items listed from inside the oven. Clean the door gasket and around the door as instructed.
2. Close the oven door.
3. Press the **SELF CLEAN** key.
4. Press the **START TIME** key.
5. Enter the desired start time. For example, press **1-2-3-0** for 12:30. You may enter a time up to 22 hours and 59 minutes ahead of the present time.
6. Press **START · CONTINUE**.
7. When you press **START**, "Delay" will appear on the display and the oven door will lock. The oven will start to self clean at the time you have selected.

While the oven is set to clean at a later time:

- If you want the display to return to the clock, you may push the **CLOCK** key.
- If the clock is displayed, you may push the **START TIME** key to check the self clean start time.
- When self clean starts, "Delay" will disappear and "ON" will appear on the display.

To cancel the time delayed self clean cycle:

- Press **CANCEL · SECURE**.
- If the self clean process has not started, allow about a minute for the door to unlock before attempting to use the oven.
- If the oven is in the middle of the self clean process, the door will unlock when the oven has cooled down enough to open safely. The oven will still be hot (about 400 °F).

Cleaning the Glass Cooktop Surface

WARNING

- Unless otherwise specified, make sure that all cooking zones are cool enough to safely touch before cleaning.
- Always clean the cooktop cautiously. If using a damp sponge or cloth, wait until the cooktop has cooled to prevent steam burns.
- To avoid dangerous fumes and damage to the cooktop, use only the cleaners specified. Use them only as instructed. Do not use abrasive cleaners or scrubbers. They may cause permanent damage.
- When removing heavy spills, use only the included razor blade scraper or a plastic spatula. Do not remove heavy spills with sharp objects like a knife or metal spatula. Using objects other than those specified may scratch the surfaces.

Cleaners To Avoid

These types of cleaners can discolor, scratch, stain, mark or etch the glass or trim.

- Glass cleaners containing chlorine bleach or ammonia.
- Caustic cleaners, such as oven cleaners.
- Abrasive cleaners (i.e.: metal scouring pads, Scotch Brite, sponges, S.O.S. pads)
- Powder or liquid cleaners containing chlorine bleach or abrasives/cleaners.
- Flammable cleaners.

Special Cleaning Methods

The following applies to the glass surface only:

- **Sugar, syrup, tomato spills** - REMOVE THESE TYPES OF SPILLS IMMEDIATELY, WHILE THE COOKTOP SURFACE IS HOT. USE A PLASTIC SPATULA OR THE INCLUDED RAZOR BLADE SCRAPER ONLY. THIS TYPE OF CLEAN UP IS THE ONLY ONE THAT IS DONE WHEN THE COOKTOP SURFACE IS HOT! After scraping, allow the cooking surface to cool, then use a dry towel or sponge to wipe up residue.
 1. Remove utensils/pans from the cooktop and turn off the controls. Angle the scraper slightly and push spills or residue off the heated surface. Do not scratch or gouge (see diagram).
 2. Let the surface cool and remove any residue. Apply Dacor Cooktop Cleaning Crème (see following page).
- **Burned on food**
 1. Soften using a moist cloth or paper towel over the soil for 20 to 30 minutes.
 2. Wipe clean, dry and apply Dacor Cooktop Cleaning Crème (see following page).

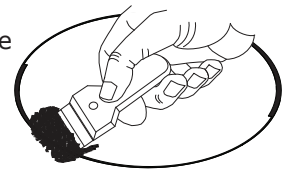

continued...

Care and Cleaning

Cleaning the Cooktop Surface (cont.)

- **Metal marks** – Utensils/pans will occasionally leave marks. If Cleaning Crème does not remove marks use a mild cleanser (i.e.: Bon Ami) to remove.

Rinse and dry surface and apply Dacor Cooktop Cleaning Crème. **NOTE:** Magnetic stainless steel and porcelain coated steel/iron pans are less likely to leave marks than other types of cookware. Uncoated cast iron pans are more likely to cause marking on the glass. Always avoid sliding cookware across the glass.

- **Water spots**

1. Apply undiluted white vinegar, rinse and dry.
2. Apply Dacor Cooktop Cleaning Crème.

- **Scratches**

Scratches cannot be removed. Avoid scratches by using clean pans and removing gritty food spillages quickly. Keep the cooktop clean and apply Dacor Cooktop Cleaning Crème often. Surface scratches will not affect cooking capability.

How to use Dacor Cooktop Cleaning Creme

- Regular use of Dacor Cooktop Cleaning Crème on the glass surface will protect the surface and make it easier to remove food soil and water spots.
- To clean the cooktop, be sure it is cool, then apply about a 1/4 teaspoon of Dacor Cooktop Cleaning Creme*, to the ceramic glass surface with a lightly dampened clean cloth. Use a second clean cloth to remove any remaining cleaner residue. Wipe the cooktop surface with a dry cloth to completely eliminate any remaining moisture.

* See the **Parts and Accessories** section for reorder information.

Cleaning the Exterior Surfaces

Oven Control Panel

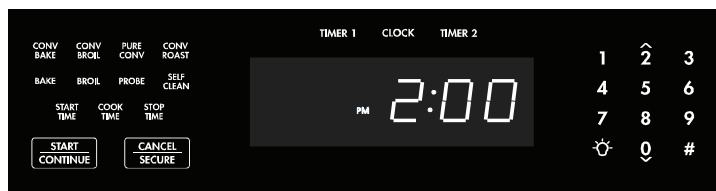

CAUTION

Do not use abrasive cleaners or scrubbers on the control panel. They will permanently damage the finish.

- To avoid accidentally turning the oven on while cleaning the control panel, activate the lock-out feature. Press the **CANCEL • SECURE** key for six seconds. The lock-out feature disables the keys. When the control panel is locked, the word **"OFF"** appears on the display.
- When you want to re-activate the control panel, press **CANCEL • SECURE** for six seconds.

- Clean the control panel with the soft side of a sponge dampened with a mild solution of detergent and warm water. Dry the control panel completely with a soft, lint-free cloth.

Stainless Steel Surfaces

CAUTION

Always wipe stainless steel (silver colored) surfaces with the grain. To prevent scratching, do not use abrasive cleaners or scrubbers on stainless steel surfaces.

Clean stainless steel surfaces with a mild solution of detergent and warm water. Rinse and dry with a soft, lint-free cloth. You may also use Dacor Stainless Steel Cleaner. Use it according to the directions on the package.

Cleaning the Oven Interior

WARNING

To avoid electrical shock or burns, turn off the oven and be sure that it is cool before cleaning.

Your oven's self clean feature eliminates the need for manual scrubbing of interior surfaces. The steps below are for cleaning surfaces and items that are not cleaned by the self clean process. See page 20.

Cleaning the Oven Door Glass Surfaces (Interior and Exterior)

- Use a mild glass cleaner to remove finger prints on glass surfaces. You may also clean the other glass surfaces with Dacor Cooktop Cleaning Creme. Use it according to the directions on the package.
- You may scrub the oven light lens with the rough side of a sponge and warm, soapy water. Be careful not to scratch the lens.

Door Gasket (Seal)

WARNING

Take care when cleaning the door gasket. Rubbing or displacing it may damage the tight door seal required for proper cooking and self cleaning.

Clean the door gasket by dabbing it with a solution of water and mild soap. Do not scrub it or it will become damaged.

Oven Racks

To clean the oven racks, apply a solution of detergent and hot water. When you need to clean heavy soil, use a scouring pad such as steel wool with plenty of water. You may also use a solution of one cup of ammonia to two gallons of water.

Care and Cleaning

Convection Filter

WARNING

For your safety and proper oven performance, re-install the filter before using the oven to cook. If you don't, the spinning fan blades inside will be exposed.

The convection filter is located in the back of the oven chamber. Clean the filter regularly. If you allow it to become clogged, the oven's convection cooking modes will not work properly. You also need to remove the filter during the self clean cycle.

Removing your oven's convection filter:

When the oven is cool, put your fingers around the edges of the filter and gently push up.

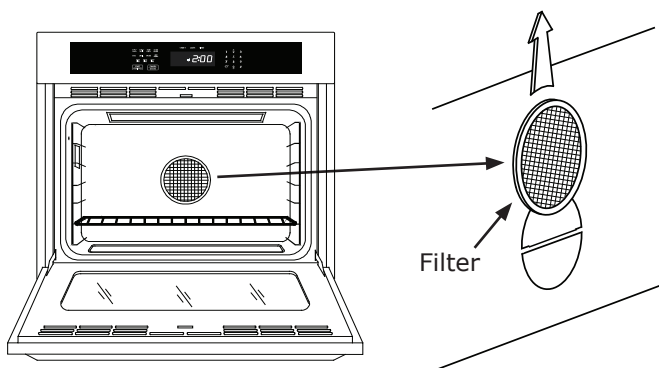

To clean the filter:

Soak it in hot, soapy water. Rinse well. You may also place it in a dishwasher on the top rack. Dry the filter before re-installing it.

Installing your oven's convection filter:

Carefully hook the metal clips on the back of the filter over the metal bar across the fan hole. Make sure it is centered over the hole. Be careful not to scratch the porcelain surfaces with the back of the filter.

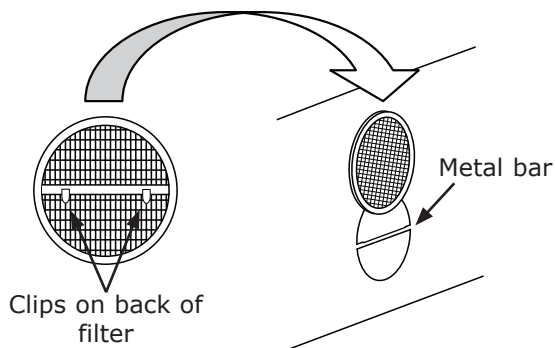

Meat Probe

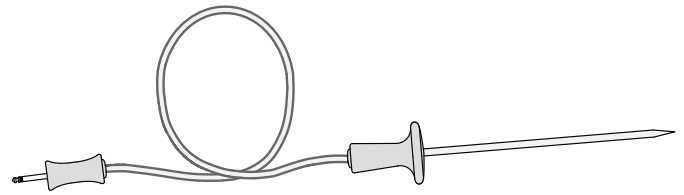

WARNING

To prevent damage, do not immerse the meat probe in water.

The meat probe is constructed of silicone handles, a wire, a plug and a stainless steel skewer. To clean the skewer, use a scouring pad and hot, soapy water. When you clean the handles, wipe them with a soft sponge soaked with a solution of detergent and warm water.

Optional Broil Pan

The broil pan has a porcelain enamel finish. When you clean it, use a solution of detergent and hot water. If the broil pan is heavily soiled, use a scouring pad with plenty of water. Rinse it well after cleaning.

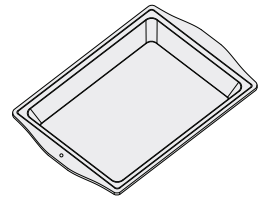

Optional Roast/Broil Pan with "V" Shaped Rack

The roast/broil pan has a porcelain enamel finish. When you clean it, use a solution of detergent and hot water. If the roast/broil pan is heavily soiled, use a scouring pad and plenty of water.

Rinse it well after cleaning.

The optional "V" Shaped rack and the grill are finished with an Excalibur™ nonstick coating. When you clean them, use a mild solution of detergent and warm water. Use the soft side of a sponge to scrub them and dry them with a lint-free cloth.

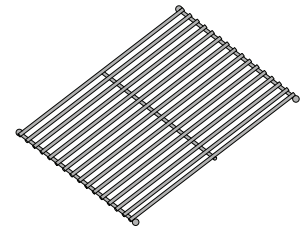
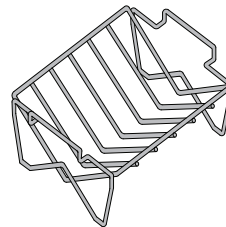

continued...

Care and Cleaning

Cleaning the Oven Interior (cont.)

Optional Cookie Sheets

Clean the optional aluminum cookie sheets with a solution of detergent and warm water. Since aluminum can scratch, you need to use the soft side of a sponge. A way for you to keep cookie sheets cleaner is to use parchment paper over the cooking surface during baking. The parchment paper will also prevent food from sticking.

Optional Baking Stone

Wash the optional baking stone with hot water and scrub it clean before you use it for the first time. Do not use any soap or detergents to wash the it. The stone is porous and soap will get trapped inside. The trapped soap will affect the flavor of the food cooked on it. Do not be alarmed if the stone gets stains on it after it is used for a while. Stains do not affect the stone's ability to bake properly.

When you need to remove large food particles from the baking stone, use warm water and a scrub brush. If there is a lot of oil build-up, it may smoke and create odors. If you need to remove the oily build up, use a scouring pad or brush to remove it. You may also use a paste of baking soda and water to scrub off small stains.

Replacing the Light Bulb(s)



WARNING

- To prevent electrical shock and/or personal injury, make certain that the oven and light bulb are cool and that power to the range has been turned off at the circuit breaker panel or fuse box before replacing the light bulb.
 - Always make sure the lens cover is in place when using the oven. The lens cover protects the bulb from breakage.
 - Replacing the lens cover without lining up the cutout with the light socket will damage the light fixture.
 - Do not use a screwdriver to remove the lens.
- Light bulb replacement is considered a homeowner maintenance operation. If the light does not work, before replacing it, please consult the **Problem Solution Guide** on page 25.
 - Replace the light bulb only with Dacor part number 107112. See page 27 for ordering information.



IMPORTANT

Do not touch the replacement halogen light bulb with your fingers. Halogen bulbs are sensitive to the oils from your hand. The oils from your hand will stick to the bulb and may cause it to burn out faster than normal.

To replace a light bulb, follow these steps:

1. Turn off power to the range at the circuit breaker panel or fuse box.
2. Hold your hand under the lens for support and gently pry it loose using a spatula or table knife. Pull the lens cover straight out.
3. Grasp the old bulb and pull it straight out of the socket.
4. Using a glove, insert the new bulb into the socket.
5. As you reinstall the lens cover, line up the cutout on the inside rim with the light socket. Gently press it into its original position.
6. Turn the power to the range back on. Reset the clock (see page 8).

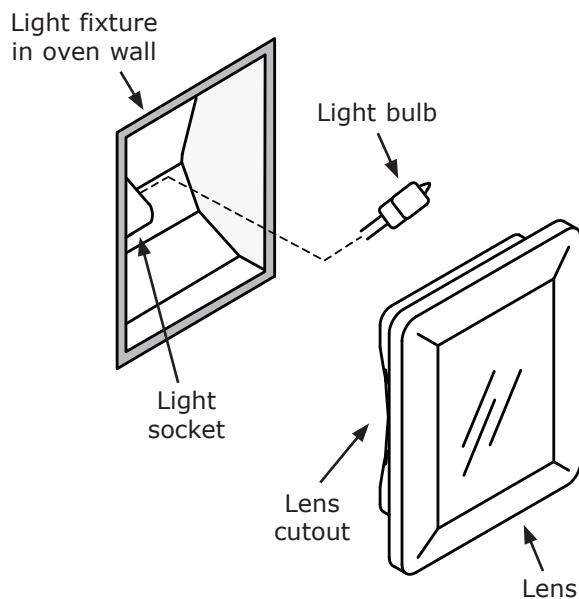

Before You Call for Service

Problem Solution Guide - Cooktop

Problem	May Be Caused By	What to Do
Nothing works.	Range not connected to electrical power.	Have an electrician connect range to properly wired electrical connection.
	Power is off.	Turn power on at circuit breaker panel or fuse box. Check for tripped circuit breaker or blown fuse.
	Power outage.	Contact power company.
Cooktop turns on and/or changes settings unexpectedly.	Fluids, food or cleaning solutions covering cooktop control panel.	Spills/cleaning solutions on control panel can cause unwanted control operation. Dry area with clean cloth, reset control(s) to desired setting.
	Power surge from power source.	A power surge from the power source can cause the cooktop to shut down. Reset controls to resume operation.
	No food or fluid in cooking utensil, can cause cooktop to shut down (safety feature).	Do not put empty cookware on cooktop. Do not allow pans to boil dry.
Cooking zone (induction element) cycles on and off more often than usual.	Utensils not centered on cooking zone.	Re-center cooking utensil.
	The bottom of the cooking utensil is not flat or is convex or concave.	Use flat bottomed utensil.
	The utensil/pan is too small in diameter for the cooking zone being used.	Use a smaller cooking zone or larger utensil.
	Material of utensil is poor heat conductor.	Try a different cooking utensil.
Utensil/cooktop vibrates or buzzes.	Improper utensil used.	Make sure utensil meets requirements on page 7.
	Cooktop wet or greasy.	Make sure cooktop is clean and dry before use.
Food/cookware does not heat.	No power.	See nothing works, above.
	Non-magnetic utensil used.	Induction cooktops do not work unless utensil is magnetic. Try another type of utensil.
Food takes a long time to heat.	Cookware being used is only slightly magnetic.	Try another type of utensil.
	Power management feature.	See page 6 for cookware placement suggestions.
	Supply voltage too low.	Have a licensed electrician check supply voltage.

Problem Solution Guide - Oven

NOTE: See **Common Problems When Using Bake Mode** on page 11 for problems with baking.

Problem	May Be Caused By	What to Do
Nothing works.	Range not connected to electrical power.	Have an electrician connect range to properly wired electrical connection.
	Power is off.	Turn power on at circuit breaker panel or fuse box. Check for tripped circuit breaker or blown fuse.
	Control panel locked.	Press CANCEL - SECURE key for six seconds to reactivate control panel.
	Power outage.	Contact power company.

continued...

Before You Call for Service

Problem Solution Guide - Oven (cont.)

Problem	May Be Caused By	What to Do
Oven will not heat.	Oven setting not correct.	Press CANCEL · SECURE . Follow instructions in Operating the Oven section.
	Oven set for delay timed cooking.	Oven will turn on automatically at preset time. Press CANCEL · SECURE to return to normal operation.
	Attempting to broil with meat probe connected.	Broil and convection broil settings will not work when meat probe is connected. Disconnect meat probe.
Foods over or under cook.	Incorrect cooking time or temperature.	Follow instructions in Operating the Oven section.
Oven shuts off by itself after it has been on for 12 hours.	12 hour timer is on. Unit is set to turn off automatically after 12 hours of continuous use.	Turn off 12 hour timer. See page 10.
Time on display not correct.	Time of day not set.	Set time. See Setting Up Your Range .
	Power failure or power was turned off.	Reset time. See Setting Up Your Range .
Time flashes on display.	Power failure or power was turned off.	Reset time. See Setting Up Your Range .
Cannot set clock.	Oven in use. Clock cannot be set while oven is in use.	Turn off oven to set clock.
Oven does not self clean.	Door not shut tightly.	Check for obstructions. Close door tightly.
	Oven set for delay timed cleaning.	Oven will start to self clean at preset time. Press CANCEL · SECURE to return to normal operation.
	Oven not set properly.	Follow instructions in Care and Cleaning section.
	Meat probe connected.	Oven will not start self clean cycle when meat probe is connected. Disconnect and remove meat probe.
Oven light does not work (burners light and oven works OK).	Oven in self clean mode.	Light does not work when oven is in self clean mode.
	Oven in Sabbath mode.	Light does not work when oven is in Sabbath mode. See page 15.
	Light bulb burned out.	Replace light bulb. See Care and Cleaning section.
Oven light will not turn off.	Light key is set to on.	Press light key to turn light off.
Cooling fan continues to run after oven is turned off.	Normal operation.	The cooling fan may run for a while after the oven is turned off, until the internal parts have cooled.
Sabbath mode does not work.	Meat probe connected.	Oven will not start Sabbath mode when meat probe is connected. Disconnect and remove meat probe.
Oven door will not open.	Oven is set to self clean.	Check display. If lock symbol appears on display oven door cannot be opened. Wait for oven to complete self clean process or press CANCEL · SECURE . Door will unlock once oven has cooled.
Error code appears and stays on display, for example "U55."	An error code having a letter with a number following it that appears and stays on the display indicates a problem that cannot be resolved by the customer.	Call for service.

Parts and Accessories

Description	Dacor Part Number
Halogen light bulb (120 Volt 20 Watt)	107112
Dacor Stainless Steel Cleaner	A302
Dacor Cooktop Cleaning Cream	A300
Meat probe	72723
Wok ring	AWR4
Standard broil pan and broil pan grill	AER30BP
Large capacity roast/broil pan with "V" shaped rack	AORPVR
3 inch backguard kit	ADRB30E03
6 inch backguard kit	ADRB30E06
9 inch backguard kit	ADRB30E09
30 Inch standard type oven rack	106992
GlideRack type oven rack	701464*, ARG030H**
Pizza baking stone	ABS16
Cookie sheets*** (three per carton)	ACSRO303

* Use this number for ordering a replacement under warranty.

** Use this number for ordering additional racks, not covered under warranty.

*** Dacor full sized cookie sheets maximize oven rack baking capabilities by utilizing the total usable rack space.

To order parts and accessories, contact your Dacor dealer or visit www.everythingdacor.com.

Warranty and Service

Getting Help

Before you request service:

1. Review the **Before You Call For Service** section of this manual (page 25).
2. Use the helpful tips found in our **Problem Solution Guide**.
3. Become familiar with the warranty terms and conditions of your product on the following page.
4. If none of these tips or suggestions resolves your problem, call our Customer Service center at the number below.

Dacor's Customer Service center is available 6:00 A.M. – 5:00 P.M. Pacific Time

For warranty repairs or questions and for Dacor Distinctive Service (DDS) in the US and Canada
Phone: (800) 793-0093, extension 2822

For non-warranty repairs or questions in the US and Canada
Phone: (800) 793-0093, extension 2813

Contact us through our web site at:

www.dacor.com/contact-us

Warranty and Service

Warranty

What Is Covered

CERTIFICATE OF WARRANTIES: DACOR RANGES

WITHIN THE FIFTY STATES OF THE U.S.A., THE DISTRICT OF COLUMBIA AND CANADA*:

FULL ONE-YEAR WARRANTY

The warranty applies only to the Dacor appliance sold to the first use purchaser, starting from the date of original retail purchase or closing date for new construction, whichever period is longer. Warranty is valid on products purchased brand new from a Dacor Authorized Dealer or other seller authorized by Dacor.

If your Dacor product fails to function within one year of the original date of purchase, due to a defect in material or workmanship, Dacor will remedy it without charge to you.

All cosmetic damage (such as scratches on stainless steel, paint/porcelain blemishes, etc.) to the product or included accessories must be reported to Dacor within 60 days of the original purchase date to qualify for warranty coverage.

Consumable parts such as filters and light bulbs are not covered and are the responsibility of the purchaser.

LIMITATIONS OF COVERAGE

Service will be provided by a Dacor designated service company during regular business hours. Please note service providers are independent entities and are not agents of Dacor.

Dealer display and model home display products with a production date greater than 5 years, products sold "As Is," and products installed for non-residential use, which include but are not limited to religious organizations, fire stations, bed and breakfast and spas carry a one year parts warranty only. All delivery, installation, labor costs and other service fees are the responsibility of the purchaser. Warranty will be null and void on product that has altered, defaced or missing serial numbers and tags.

The owner must provide proof of purchase or closing statement for new construction upon request. All Dacor products must be accessible for service.

*Warranty is null and void if non-ETL or non-CUL approved product is transported from the U.S.A.

OUTSIDE THE FIFTY STATES OF THE U.S.A., THE DISTRICT OF COLUMBIA AND CANADA:

LIMITED FIRST YEAR WARRANTY

If your Dacor product fails to function within one year of the original date of purchase due to a defect in material or workmanship, Dacor will furnish a new part, F.O.B. factory to replace the defective part.

All delivery, installation, labor costs and other service fees are the responsibility of the purchaser.

What Is Not Covered

- Slight color variations may be noticed because of differences in painted parts, kitchen lighting, product placement and other factors; this warranty does not apply to color variation.
- Service calls to educate the customer on proper use and care of the product.
- Service fees for travel to islands and remote areas, which include but are not limited to, ferries, toll roads or other travel expenses.
- Consequential or incidental damage, including but not limited to food or medicine loss, time away from work or restaurant meals.
- Failure of the product when used for commercial, business, rental or any application other than for residential consumer use.
- Failure of the product caused by improper product installation.
- Replacement of house fuses, fuse boxes or resetting of circuit breakers.
- Damage to the product caused by accident, fire, flood, power interruption, power surges or other acts of God.
- Liability or responsibility for damage to surrounding property including cabinetry, floors, ceilings and other structures or objects around the product.
- Breakage, discoloration or damage to glass, metal surfaces, plastic components, trim, paint or other cosmetic finish caused by improper usage, care, abuse or neglect.

Out of Warranty

Should you experience a service issue beyond the standard warranty period, please contact us. Dacor reviews each issue and customer concern to provide the best possible solution based on the circumstances.

THE REMEDIES PROVIDED IN THE ABOVE EXPRESS WARRANTIES ARE THE SOLE AND EXCLUSIVE REMEDIES. THEREFORE, NO OTHER EXPRESS WARRANTIES ARE MADE, AND OUTSIDE THE FIFTY STATES OF THE UNITED STATES, THE DISTRICT OF COLUMBIA AND CANADA, ALL IMPLIED WARRANTIES, INCLUDING BUT NOT LIMITED TO, ANY IMPLIED WARRANTY OF MERCHANTABILITY OR FITNESS FOR A PARTICULAR USE OR PURPOSE, ARE LIMITED IN DURATION TO ONE YEAR FROM THE DATE OF ORIGINAL PURCHASE. IN NO EVENT SHALL DACOR BE LIABLE FOR INCIDENTAL EXPENSE OR CONSEQUENTIAL DAMAGES. IN THE EVENT DACOR PREVAILS IN ANY LAWSUIT, DACOR SHALL BE ENTITLED TO REIMBURSEMENT OF ALL COSTS AND EXPENSES, INCLUDING ATTORNEY'S FEES, FROM THE DACOR CUSTOMER. NO WARRANTIES, EXPRESS OR IMPLIED, ARE MADE TO ANY BUYER FOR RESALE.

Some states do not allow limitations on how long an implied warranty lasts, or do not allow the exclusion or limitation of inconsequential damages, therefore the above limitations or exclusions may not apply to you. This warranty gives you specific legal rights, and you may also have other rights that vary from state to state.

fold here



NO POSTAGE
NECESSARY
IF MAILED
IN THE
UNITED STATES

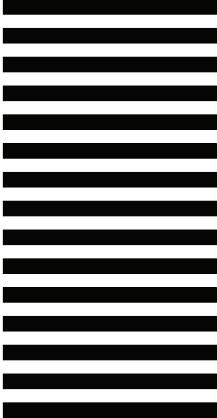

BUSINESS REPLY MAIL
FIRST-CLASS MAIL PERMIT NO 1600 CITY OF INDUSTRY CA

POSTAGE WILL BE PAID BY ADDRESSEE

**DACOR
ATTN WARRANTY PROCESSING DEPT
PO BOX 90070
CITY OF INDUSTRY CA 91715-9907**





Please visit www.dacor.com to activate your warranty online.

WARRANTY INFORMATION



IMPORTANT:

Your warranty will not be activated until you activate it online or return this form to Dacor. If you have purchased more than one Dacor product, please return all forms in one envelope or activate the warranty for each product online.

Please rest assured that under no conditions will Dacor sell your name or any of the information on this form for mailing list purposes. We are very grateful that you have chosen Dacor products for your home and do not consider the sale of such information to be a proper way of expressing our gratitude!

Owner's Name: _____
Last (Please Print or Type) First Middle

Street: _____

City: _____ State: _____ Zip: _____

Purchase Date: _____ Email: _____ Telephone: _____

Dealer: _____

City: _____ State: _____ Zip: _____

Your willingness to take a few seconds to fill in the section below will be sincerely appreciated. Thank you.

1. How were you **first** exposed to Dacor products? (Please check one only.)

- A. T.V. Cooking Show
- B. Magazine
- C. Appliance Dealer Showroom
- D. Kitchen Dealer Showroom
- E. Home Show
- F. Builder
- G. Architect/Designer
- H. Another Dacor Owner
- I. Model Home
- J. Other _____

2. Where did you buy your Dacor appliances?

- A. Appliance Dealer
- B. Kitchen Dealer
- C. Builder Supplier
- D. Builder
- E. Other _____

3. For what purpose was the product purchased?

- A. Replacement **only**
- B. Part of a Remodel
- C. New Home
- D. Other _____

4. What is your household income?

- A. Under \$75,000
- B. \$75,000 – \$100,000
- C. \$100,000 – \$150,000
- D. \$150,000 – \$200,000
- E. \$200,000 – \$250,000
- F. Over \$250,000

5. What other brands of appliances do you have in your kitchen?

- A. Cooktop _____
- B. Oven _____
- C. Dishwasher _____
- D. Refrigerator _____

6. Would you buy or recommend another Dacor product?

- Yes
- No

Comments: _____

Thank you very much for your assistance. The information you have provided will be extremely valuable in helping us plan for the future and giving you the support you deserve.

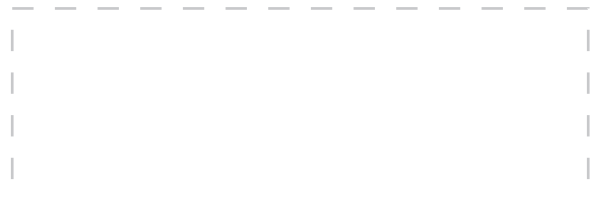

cut here

cut here

Free Manuals Download Website

<http://myh66.com>

<http://usermanuals.us>

<http://www.somanuals.com>

<http://www.4manuals.cc>

<http://www.manual-lib.com>

<http://www.404manual.com>

<http://www.luxmanual.com>

<http://aubethermostatmanual.com>

Golf course search by state

<http://golfingnear.com>

Email search by domain

<http://emailbydomain.com>

Auto manuals search

<http://auto.somanuals.com>

TV manuals search

<http://tv.somanuals.com>