

DAEWOO

OWNER'S MANUAL SPLIT AIRCONDITIONING SYSTEM

MODEL #:

DSB-122L/DSB-122LH

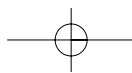
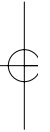
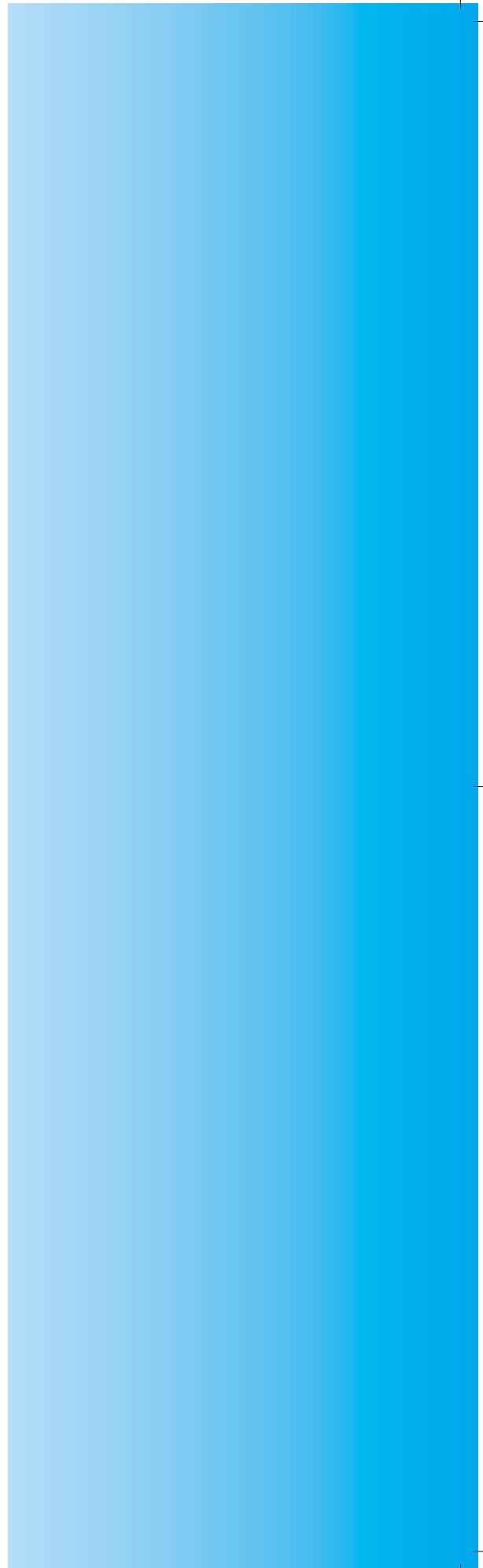

SAFETY INSTRUCTIONS

PLEASE READ THE FOLLOWING SAFETY INSTRUCTIONS BEFORE INSTALLING AND OPERATING THE UNIT:

This air conditioner meets strict safety and operating standards. The installer of this unit must install or service this unit so it operates safely and efficiently.

IMPORTANT NOTES

- Adhere to all safety instructions and warnings throughout this manual.
- Read this manual carefully before installing or operating this unit to become familiar with its features and obtain the performance that will bring you continued enjoyment for many years.
- Follow each installation or repair step exactly as shown in the manual.
- Observe all local, state and national electric codes. Contact your local government for more information on electrical codes.

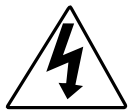

The lightning flash with arrowhead symbol, within an equilateral triangle is intended to alert the user to the presence of uninsulated dangerous voltage within the product's enclosure that may be of sufficient magnitude to constitute a risk of electric shock to persons.



The exclamation point within an equilateral triangle is intended to alert the user to the presence of important operating and maintenance (servicing) instructions in the literature accompanying the appliance.

Contact Installer if Necessary:

The installation instructions are for an experienced installer. If you are not an experienced installer, contact a local installer for help. If you require help with service, contact your certified dealer or Daewoo Electronics for additional instructions.

If Unit is Installed Improperly:

The manufacturer shall in no way be responsible for improper installation or maintenance service, including failure to follow the instructions in this manual.

WARNING:

- ELECTRICAL SHOCK CAN CAUSE SEVERE PERSONAL INJURY OR DEATH. ONLY A QUALIFIED, EXPERIENCED ELECTRICIAN/INSTALLER SHOULD ATTEMPT TO WIRE THIS SYSTEM.
- THE APPLIANCE IS NOT INTENDED FOR USE BY CHILDREN OR INFIRM PERSONS WITHOUT SUPERVISION
- YOUNG CHILDREN SHOULD BE SUPERVISED TO ENSURE THAT DO NOT PLAY WITH THE APPLIANCE

Precautions When Wiring:

- Do not plug in the unit until all connections (tubing, drain hose, mounting, etc.) have been made and double-checked.
- High voltages are present in this unit and are very dangerous. Please refer to these instructions and diagrams when wiring. Improper connections or inadequate grounding can cause accidental injury.
- This unit must be grounded in accordance with local electrical codes.
- Connect wires and pipes securely and tightly as loose connections/wiring may cause overheating at connections and a possible fire hazard.

Precautions When Transporting:

- When transporting the unit, be very careful and get help as the units are very heavy. Be careful of sharp edges on the units also.

Precautions When Installing:

- **When installing in a ceiling or wall**, make sure the ceiling/wall is strong enough to hold the unit's weight. A frame may be necessary for added support.
- **When installing in a room**, make sure the tubes are well insulated to protect the walls and furniture from sweating of the tubes.
- **When installing in moist or uneven locations**, make sure to use a raised level concrete pad or concrete blocks to provide a level, solid foundation for the outdoor unit; this prevents water damage and vibration.
- **When installing in an area of high winds**, make sure to securely anchor the outdoor unit down with bolts and a metal frame.

When Connecting Refrigerant Tubing:

- Keep all tubing as short as possible.
- Use the flare method for connecting tubing.
- Apply refrigerant lubricant to the matching surfaces of the flare and union tubes before connecting them, then tighten, making sure not to overtighten.
- Check the tubes carefully for leaks before starting the test run.

When Servicing:

- Make sure the power is off and the unit is unplugged before opening the unit to troubleshoot or repair electrical parts and wiring.
- Keep your fingers and clothing away from any moving parts.
- Clean up the site after you finish, making sure no metal scraps and wiring are left in the unit.
- The air conditioner shall be installed in accordance with the national wiring regulation.

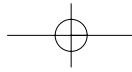

CONTENTS

It is recommended that you read the Installation and Operating instructions fully before installing and/or operating this unit.

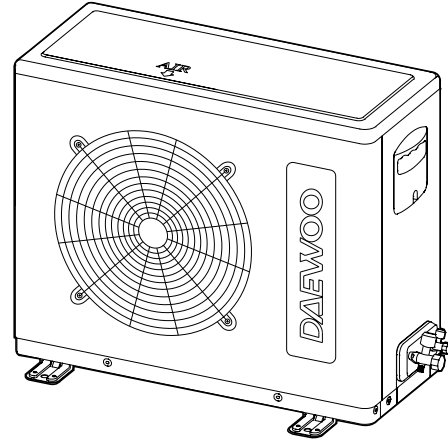
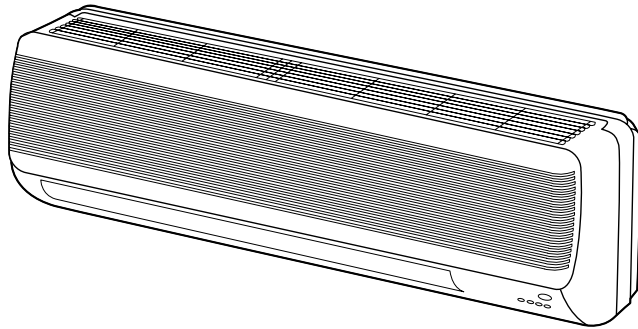

Safety Instructions	1
Contents.....	2
Basic Accessories	3
Optional Accessories.....	4
Location of Controls.....	5
Indoor Unit.....	5
Outdoor Unit	5
Remote Controller	7
Remote Display	7
Operation	9
Connecting the AC Cord	9
How to Store The Remote Controller.....	9
Setting the Unit for Remote Operation.....	9
How to Install Batteries	10
Celsius to Fahrenheit Conversion Chart.....	10
To Set Auto Mode	11
To Set Quick Mode	11
To Set Cool Mode	11
To Set Fan Only Mode.....	12
To Set Dehumidifier Mode	12
To Set Heat Mode(DSB-122LH Only)	13
To Select The Fan Direction	13
To Set On Timer Mode	14
To Set Off Timer Mode.....	14
To Set Unit to Sleep Mode.....	15
To Set Turbo/Mild Mode	15
Emergency Operation	15
Changing/Cleaning the Air Filters.....	16
Cleaning the Indoor Cover	16
Care and Maintenanc	17
Troubleshooting Guide	18
Specifications.....	19

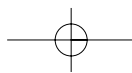

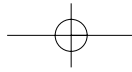

BASIC ACCESSORIES

This Installation section explains how and where to connect this new air conditioner. Please read make sure all accessories are included as shown below and read manual thoroughly. This Installation section is provided to assist the person knowledgeable in air conditioner installation and should not be installed by anybody who is not thoroughly familiar with this type of installation. Please contact a professional installer if necessary.

ACCESSORIES SUPPLIED WITH THE UNIT:

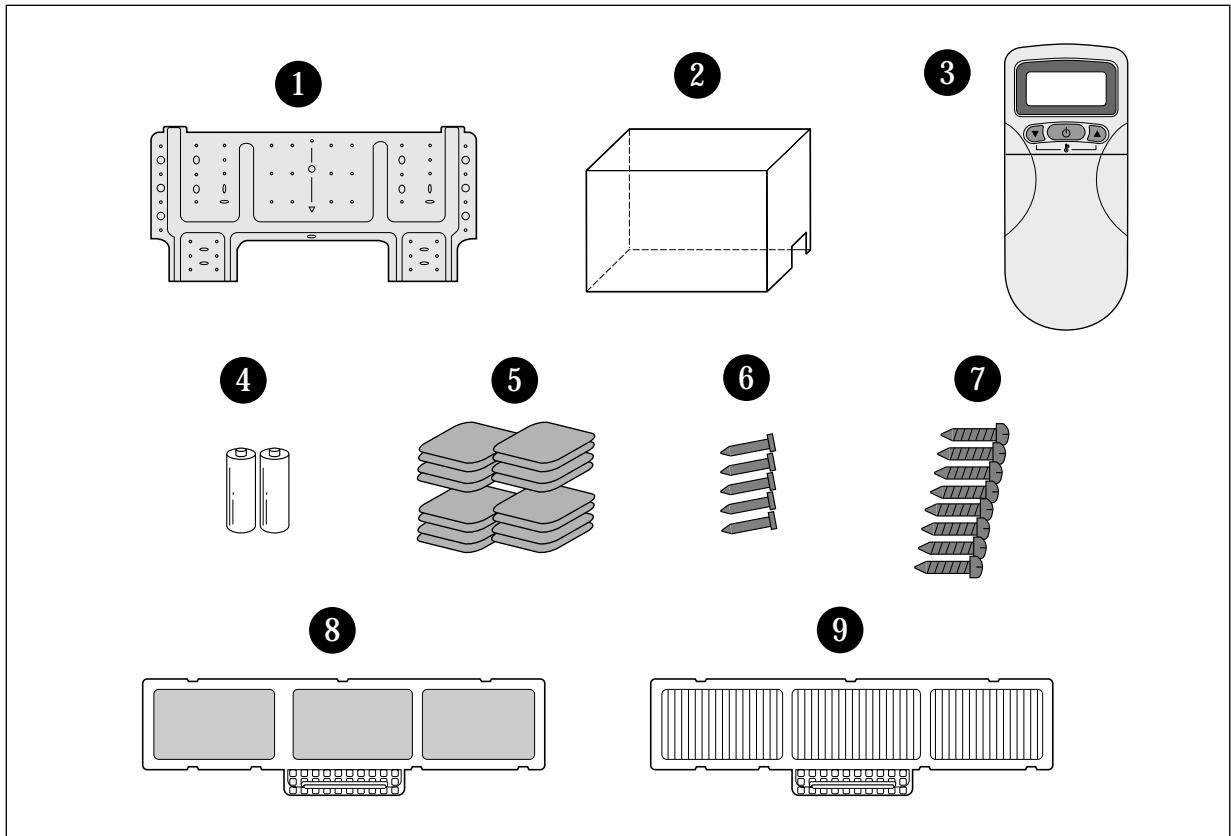

No.	Description	Qty.	No.	Description	Qty.
1	Wall Bracket	1	6	Concrete Nails	5
2	Outdoor Unit Cover	1	7	Wall Bracket Screws	8
3	Remote Controller	1	8	Deodorizing Filter	1
4	Battery	2	9	Electrostatic Filter	1
5	Foot Cushion	4			

COPPER TUBING:

Copper tubing supplied is available at most dealers or A/C shops. Make sure the new copper tubing has the exact same specifications and diameter as the original copper tubing and is as short as possible.

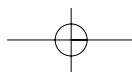

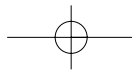

OPTIONAL ACCESSORIES

ACCESSORIES NOT SUPPLIED WITH THE UNIT:

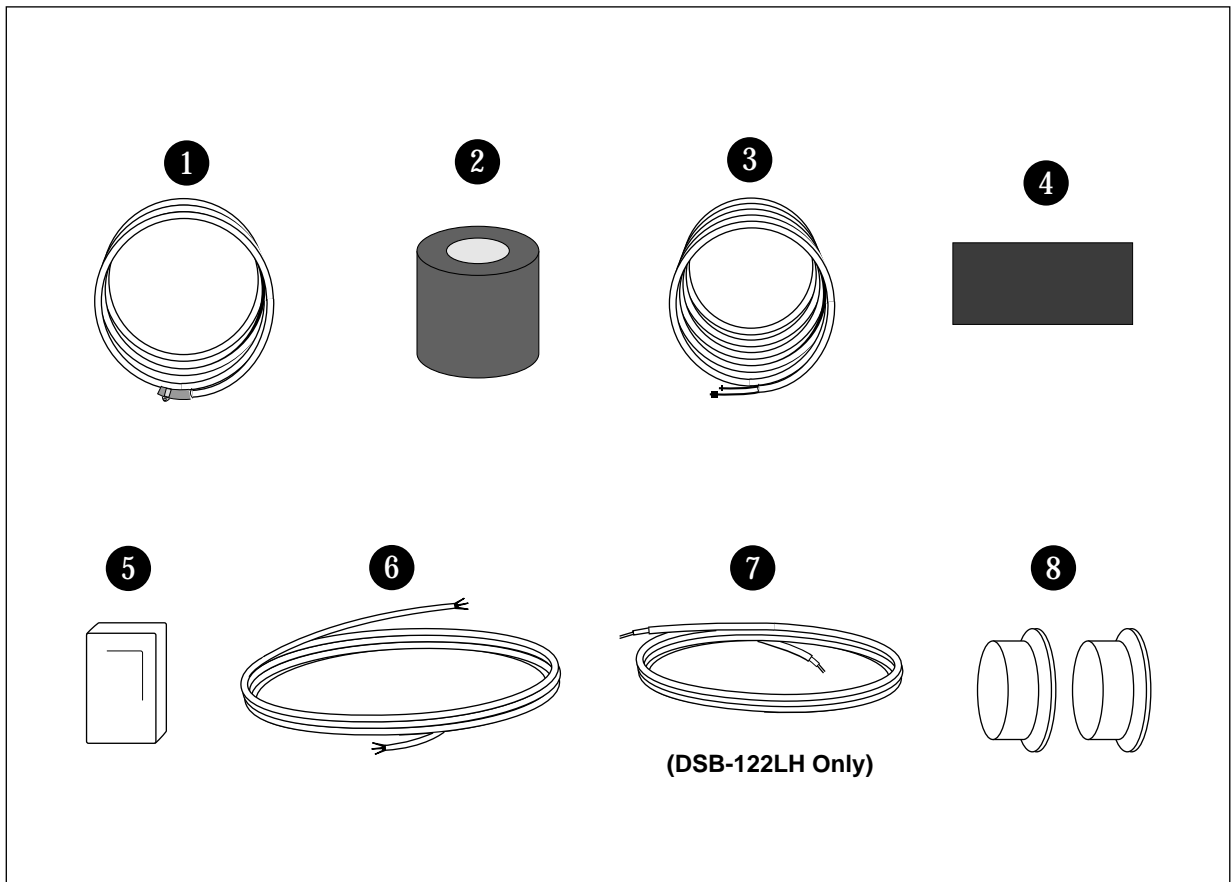

No.	Description	Part No.	Qty	Material	Size
1	Drain Hose Extension	3103200200	1	PVC	ID19.6 X 2m PVC Pipe
2	Tape	2TQ1008000	1	PVC	80W X 0.1T X 3.5m
3	Copper Tubing Extension	3100002600	1		1/2", 1/4" Copper Tube
4	Insulator Plate	3103301000	1	F-US	225 X 120 X 8T
5	Putty	2221040001	1		80g
6	Connection Cord	3102797200	1		(1.5mm ² X 6m X 3P)
7	Signal line Cord	3102796360	1		(1.5mm ² X 6m X 2P)
8	Cap Wall	3100900600	2	P.P.	
	Complete Optional Accessories (1, 2, 3, 4, 5, 6, 7, 8)	3100019000	1		

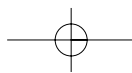

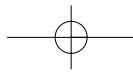

LOCATION OF CONTROLS

INDOOR UNIT

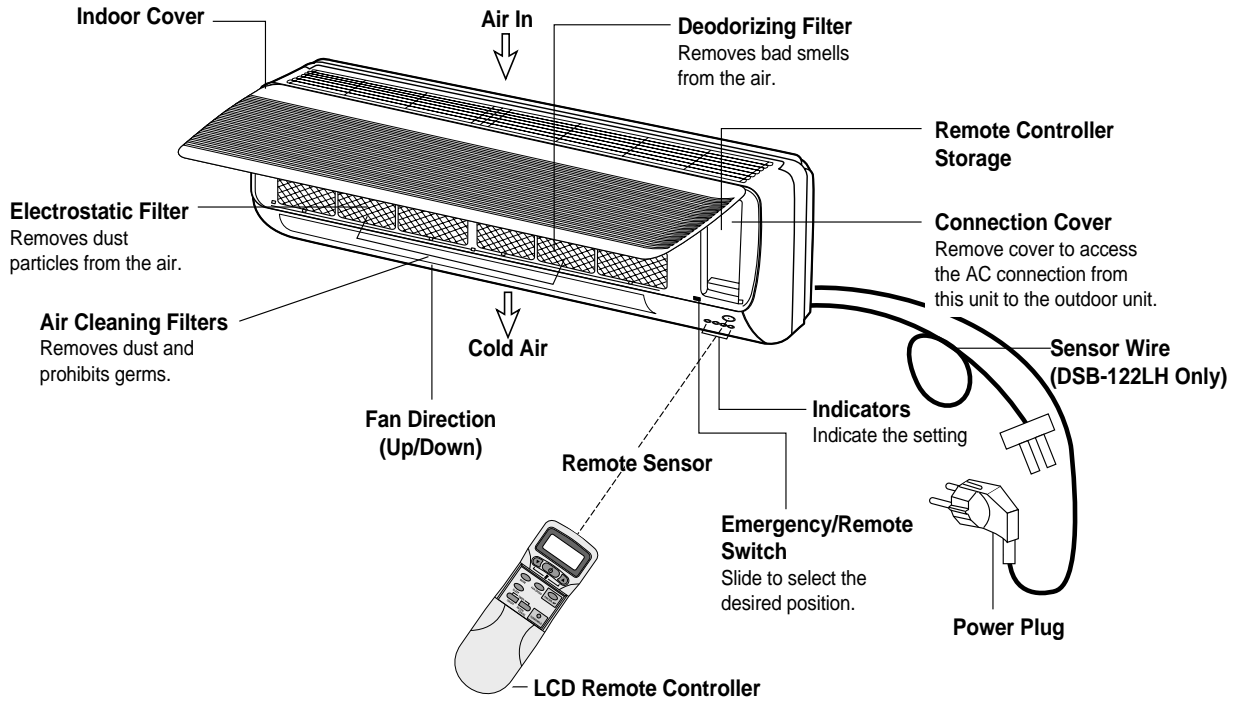

OUTDOOR UNIT

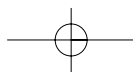
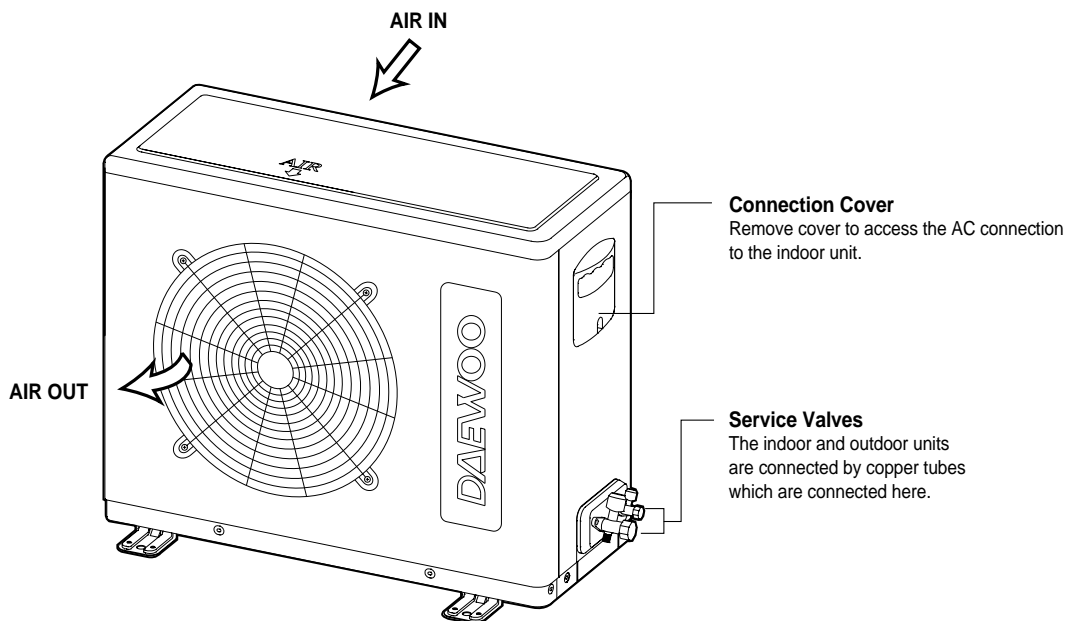

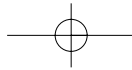

INDOOR UNIT

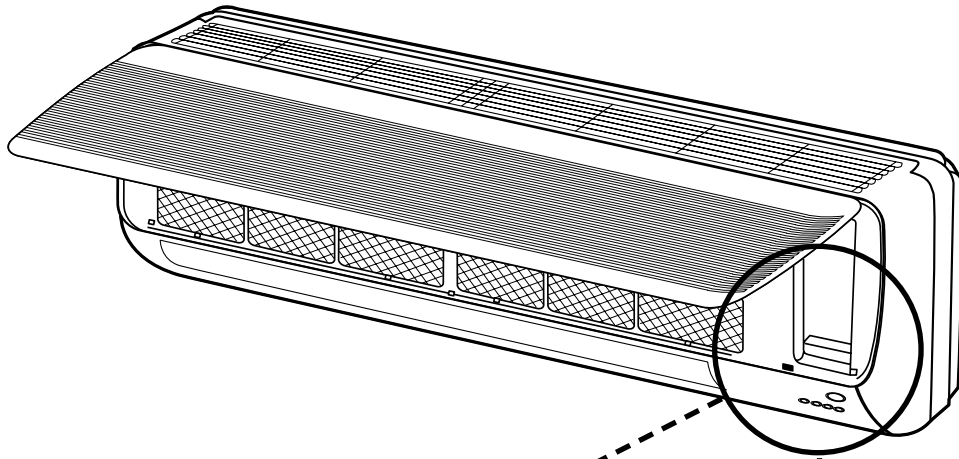

Indoor Unit Display

Remote Control Signal Receiver

This place is the part to receive the signal if it receive the signal, you can hear the signal "beep".

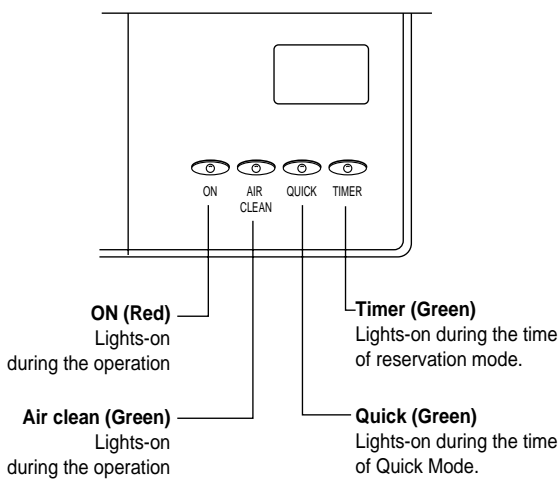

Switch Panel

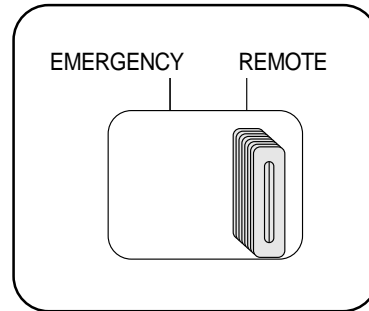

■ When the remote controller is lost or out-of-order, push the emergency button (EMERGENCY) to operate by hand.

Open the front panel on emergency operating.

Remocon switch is usually used with remote controller.

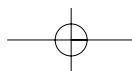

DSB-122L

REMOTE CONTROLLER

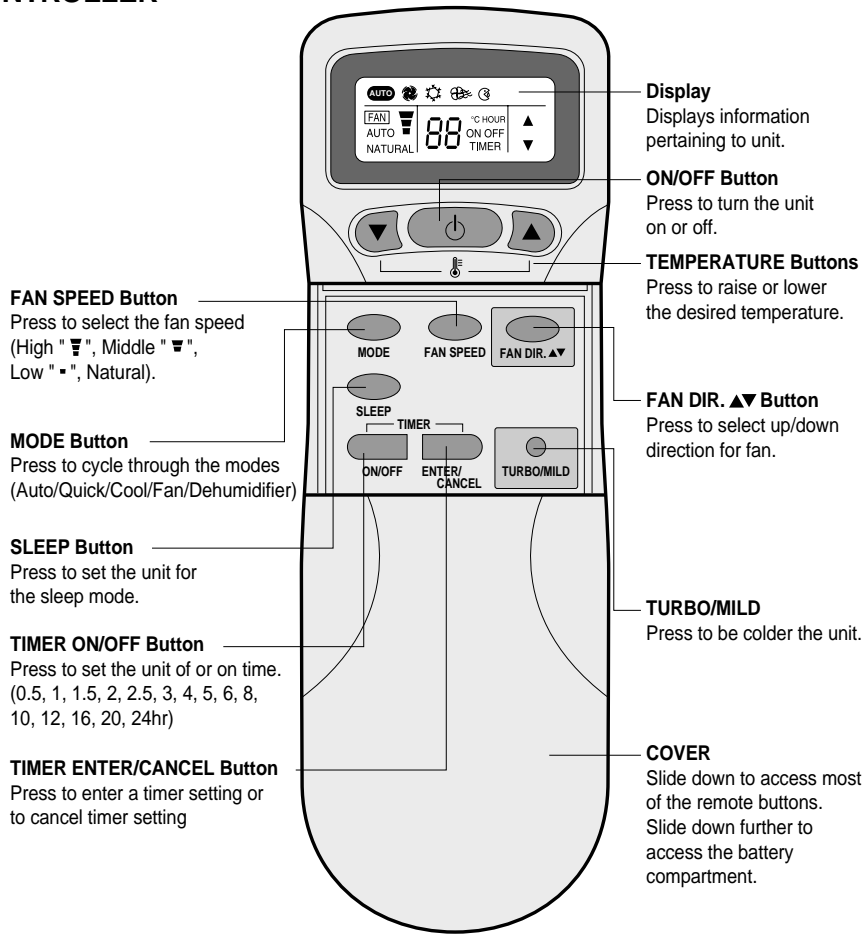

REMOTE DISPLAY

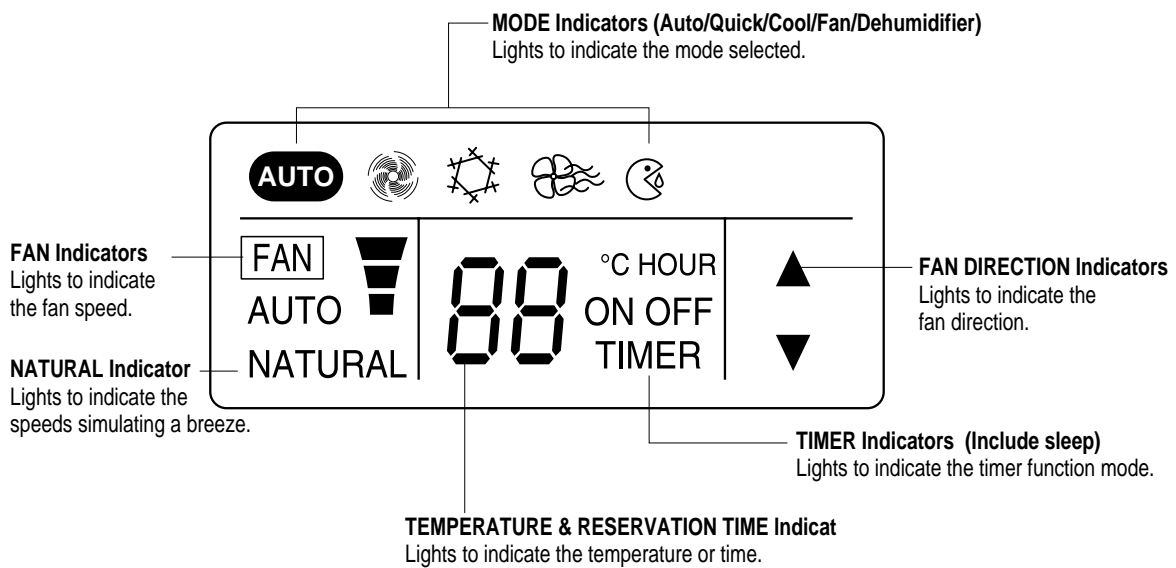

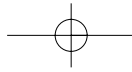

DSB-122LH

REMOTE CONTROLLER

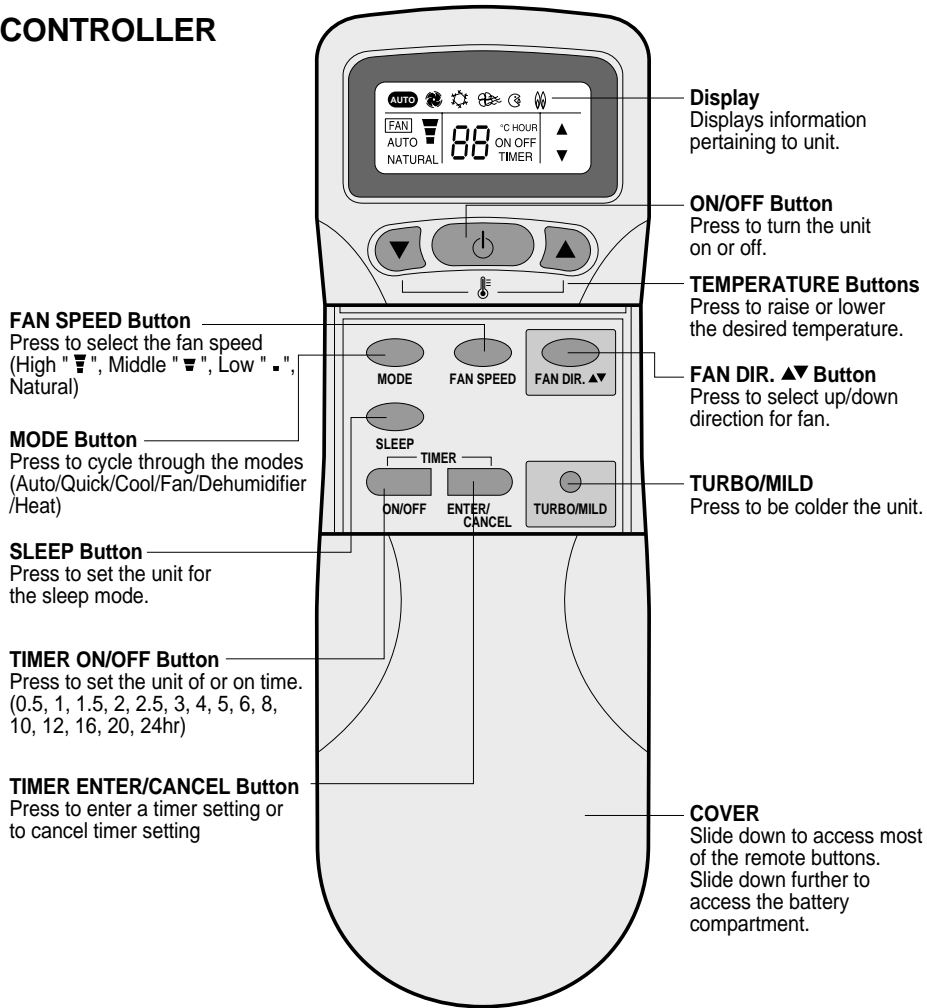

REMOTE DISPLAY

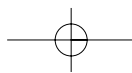
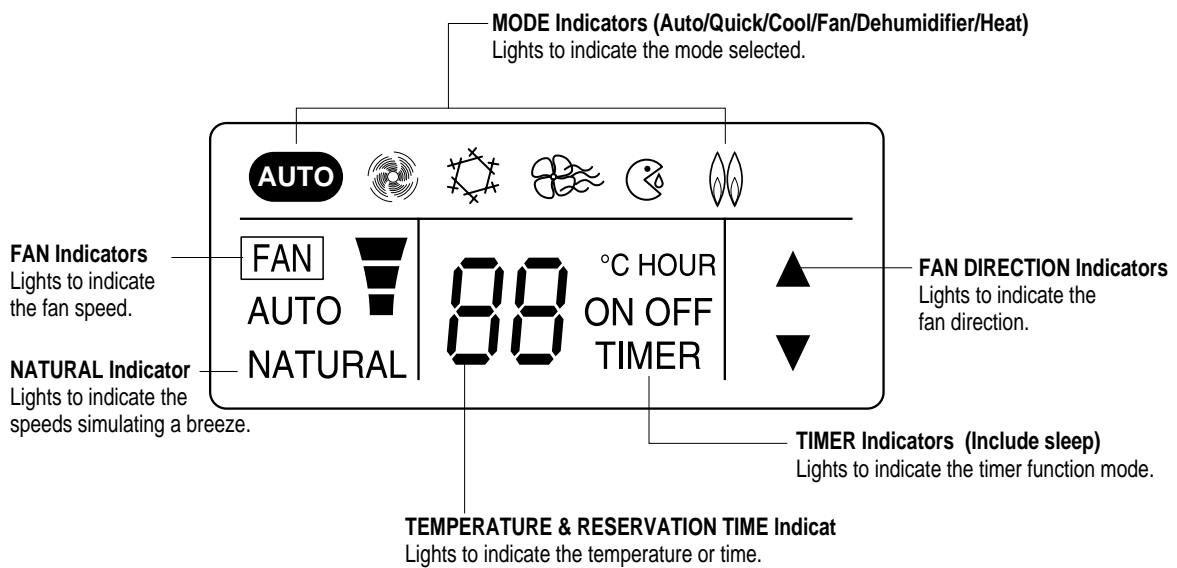

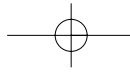

OPERATION

CONNECTING THE AC CORD

The outdoor unit is connected to the indoor unit through the AC connecting wire or connection cord. To connect the indoor unit to AC, follow the procedures below:

1. Insert the attached AC plug into a pronged 220V AC outlet.

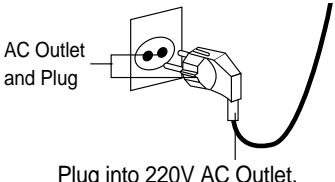

NOTES:

- Never connect the AC line cord plug to other than the specified voltage (220V).
- Use the attached power cord only.
- The new air conditioner system should be on its own 220V circuit. Contact your local electrical installer for installation.

HOW TO STORE THE REMOTE CONTROLLER

To store the remote controller, follow the procedures below:

1. Remove the left and right side to open the indoor cover upward.

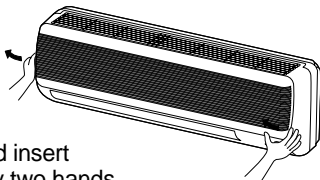

- Please remove and insert the indoor cover by two hands.

2. Store the remote controller.

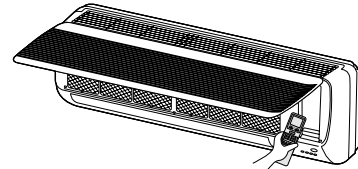

(Remove it when using)

3. Press the left and right side to close the indoor cover.

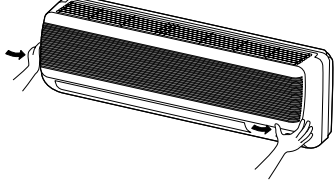

SETTING THE UNIT FOR REMOTE OPERATION

After the unit is fully connected and plugged in, it can be turned on. To turn the unit on and set it for remote operation, follow the procedures below:

1. Open the indoor unit's cover and make sure the EMERGENCY/REMOTE switch is set to the REMOTE position; this will allow the unit to operate with the remote controller.

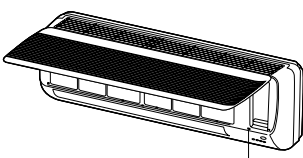

EMERGENCY/REMOTE Switch

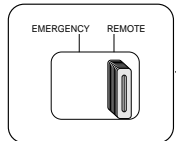

2. Press the ON/OFF button on the remote controller to turn on the unit. The On LED will light on the indoor unit and "ON" will light in the remote display. To select the various modes and settings, read the following pages.



THREE MINUTE COMPRESSOR DELAY

- After turning the indoor unit on and setting it for air conditioner operation, the compressor (outdoor unit) will not come on for three minutes. This is a feature that will protect the compressor from damage due to quick start and stops.

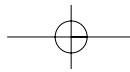

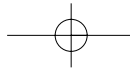

HOW TO INSTALL BATTERIES

To install the batteries, follow the procedures below:

<p>1. Slide down the cover to access most of the remote buttons. Slide down further to access the battery compartment.</p>	<p>2. Insert two "AAA" size Alkaline batteries following the polarity diagram below.</p>
--	--

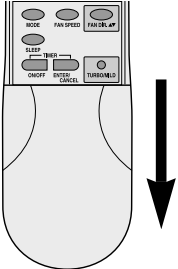
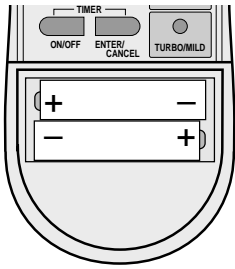
BATTERY PRECAUTIONS

The precautions below should be followed when using batteries in this device:

1. Use only the size and type of batteries specified.
2. Be sure to follow the correct polarity when installing the batteries as indicated in the battery compartment. Reversed batteries may cause damage to the device.
3. Do not mix different types of batteries together (e.g. Alkaline and Carbon-zinc) or old batteries with fresh ones.
4. If the device is not to be used for a long period of time, remove the batteries to prevent damage or injury from possible battery leakage.
5. Do not try to recharge batteries not intended to be recharged; they can overheat and rupture. (Follow battery manufacturer's directions).

CELSIUS TO FAHRENHEIT CONVERSION CHART

CELSIUS	FAHRENHEIT	CELSIUS	FAHRENHEIT
18	64.4	26	78.8
19	66.2	27	80.6
20	68	28	82.4
21	69.8	29	84.2
22	71.6	30	86
23	73.4	31	87.8
24	75.2	32	89.6
25	77		

NOTES:

- When operating the remote controller, make sure there are no obstructions between the remote controller and the remote sensor.
- After a while the display goes blank to conserve battery power. To check the settings, press the ON/OFF button once.

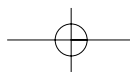

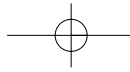

TO SET AUTO MODE

This unit will automatically operate the unit according to its surroundings while in the Auto mode. All you have to set is the desired temperature and it will control the fan, coolness and dehumidifier. Follow procedures below:

1. Press the ON/OFF button on the remote control to turn the unit on; the On LED will light on the indoor unit and "ON" will light in the remote display.

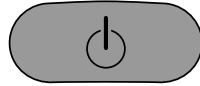

2. Make sure the AUTO indicator **AUTO** appears in the remote display. Using the TEMP. or buttons, set the desired temperature. The desired temperature can be changed up or down 1 degree from the actual room temperature. For temperature setting: 24~28°C

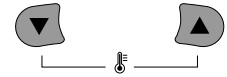

3. Then the unit will automatically operate.

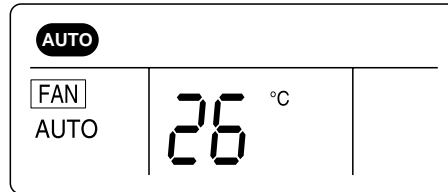
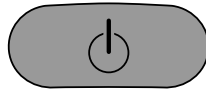

TO SET QUICK MODE

To set this unit to cool at the highest power, follow the procedures below:

1. Press the ON/OFF button on the remote control to turn the unit on; the On LED will light on the indoor unit and "ON" will light in the remote display.

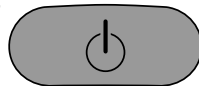

2. Press the MODE button until the Quick indicator appears in the display.

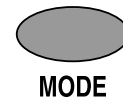

3. The unit will then start cooling the room at the highest power.

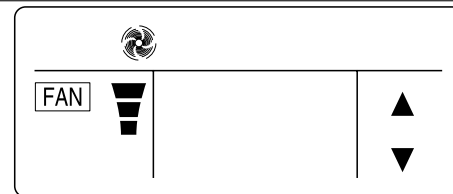

TO SET COOL MODE

To set the unit to cool the room to a desired temperature, follow the procedures below:

1. Press the ON/OFF button on the remote control to turn the unit on; the On LED will light on the indoor unit and "ON" will light in the remote display.

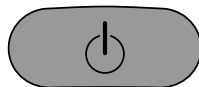

2. Press the MODE button until the Cool indicator appears in the display.

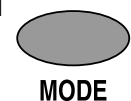

3. Using the TEMP. or buttons, set the desired temperature. The desired temperature can be changed up to 32°C and down to 18°C.



4. To select the fan speed, press the FAN SPEED button until the desired speed appears in the display (see below).

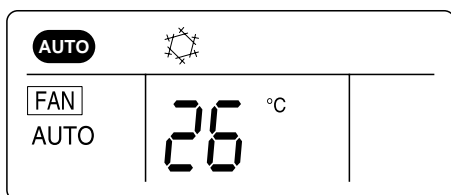

FAN SPEEDS

- "AUTO" The fan will automatically select the fan speed.
- "" The fan will operate on low speed.
- "" The fan will operate on medium speed.
- "" The fan will operate on high speed.
- "NATURAL" The fan will randomly cycle through the speeds simulating a cool breeze.

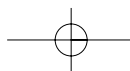

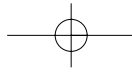



TO SET FAN ONLY MODE

To operate only the fan so the unit will circulate the air, proceed as follows:

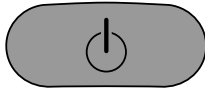
1. Press the ON/OFF button on the remote control to turn the unit on; the On LED will light on the indoor unit and "ON" will light in the remote display.



2. Press the MODE button until the Fan indicator  appears in the display. No allowance setting temperature



MODE

3. To select a fan speed, press the FAN SPEED button until the desired speed appears in the display (see below).



FAN SPEED

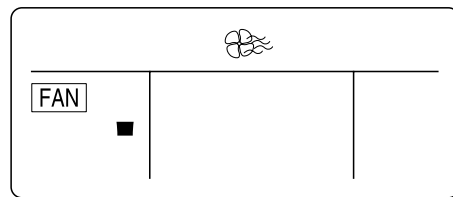

FAN SPEEDS

- "■" The fan will operate on low speed.
- "▣" The fan will operate on medium speed.
- "▤" The fan will operate on high speed.
- "NATURAL" The fan will randomly cycle through the speeds simulating a breeze.

NOTE:

- If "NATURAL" is selected, the "NATURAL" indicator on the indoor unit will light.

TO SET DEHUMIDIFIER MODE

Select this mode when there is high humidity. To select, follow the procedures below.

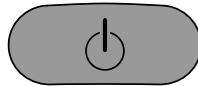

1. Press the ON/OFF button on the remote control to turn the unit on; the On LED will light on the indoor unit and "ON" will light in the remote display.



2. Press the MODE button until the Dehumidifier indicator  appears in the display.



MODE

3. Using the TEMP.  or  buttons, set the desired temperature. The desired temperature can be changed up to 32°C and down to 18°C.

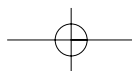
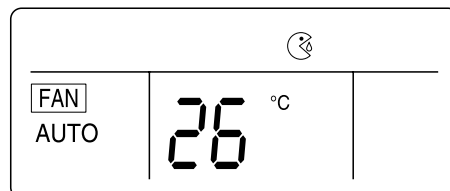

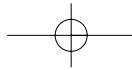

TO SET HEAT MODE (DSB-122LH ONLY)

To set the unit to heat the room to a desired temperature, follow the procedures below:

1. Press the ON/OFF button on the remote control to turn the unit on; the On LED will light on the indoor unit and "ON" will light in the remote display.

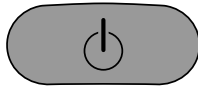

2. Press the MODE button until the Heat indicator appears in the display. In the heat mode, the fan direction or is further downward than that in the cool mode for the good circulation.

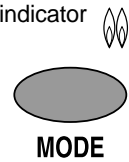

3. Using the TEMP. or buttons, set the desired temperature. The desired temperature can be changed up to 32°C and down to 18°C.



4. To select the fan speed, press the FAN SPEED button until the desired speed appears in the display (see below).



NOTE:

When the heating operation is started, hot air delivery might be delayed due to warm up period.

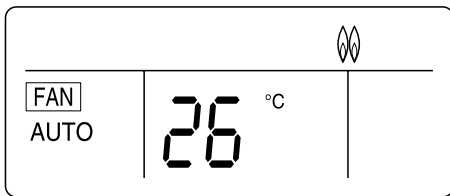

FAN SPEEDS

- "AUTO" The fan will automatically select the fan speed.
- " " The fan will operate on low speed.
- " " The fan will operate on medium speed.
- " " The fan will operate on high speed.
- "NATURAL" The fan will randomly cycle through the speeds simulating a cool breeze.

TO SELECT THE FAN DIRECTION

Regardless of the mode the unit is set for, the fan direction can be changed so it moves up and down, left and right or both. Follow procedures below to set fan direction.

1. Press the ON/OFF button on the remote control to turn the unit on; the On LED will light on the indoor unit and "ON" will light in the remote display.

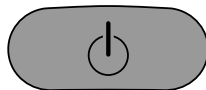

2. Press the MODE button to select the desired mode.

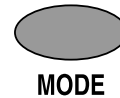

3. Press the FAN DIR. button to select the fan direction. See chart below for detailed information on each of the three settings.

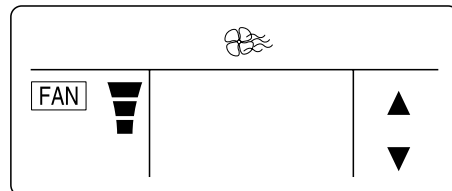

FAN DIR. ▲▼ First Press		The air will flow up and down.
Second Press		Normal air direction.

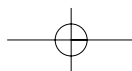

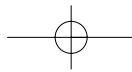

TO SET ON TIMER MODE

This unit can be set to automatically turn on after a predetermined amount of hours (up to 24) in the order of 0.5, 1, 1.5, 2, 2.5, 3, 3.5, 4, 5, 6, 8, 10, 12, 16, 20, 24.

1. Press the ON/OFF button of timer on the remote control to set the on timer mode, "HOUR" and "ON" on the remote display will be displayed and "TIMER" will be flicked. When you increase to press "ON/OFF" you will get desired time. Then, if pressing "ENTER/CANCEL" button, ON TIMER Mode will be started. If you want to stop ON TIMER Mode, please press "ENTER/CANCEL" again.

2. While the unit is off, press the TIMER ON button; the display will light waiting input for the timer, but the actual unit will not turn on.

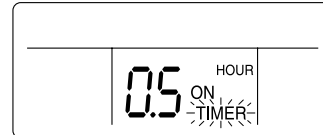
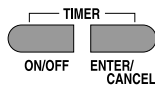

3. Repeatedly press the TIMER ON button until the desired hour that you want the unit to turn on appears on the display. For example, if it is 1:00 P.M. and you want the unit to turn on at 4:00 P.M., select 3 hours.

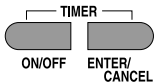

4. Press the ENTER button to input the setting into memory; the unit will beep, the TIMER indicator will light on the unit and the TIMER indicator on the remote will light to indicate the unit is in the timer mode.

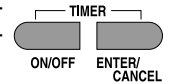

5. Place the remote controller so it is facing the unit. When the desired hour is reached, the unit will turn on to the selected mode.

NOTE : Press the ENTER button within 5 seconds of selecting the desired time. If more than 5 seconds elapse, steps 3 and 4 must be repeated.



TO SET OFF TIMER MODE

This unit can be set to automatically turn off after a predetermined amount of hours (up to 12) in the order of 0.5, 1, 1.5, 2, 2.5, 3, 3.5, 4, 4.5, 5, 5.5, 6, 6.5, 7, 7.5, 8, 8.5, 9, 9.5, 10, 11, 12.

1. Press the ON/OFF button of timer on the remote control to set the off timer mode, "HOUR" and "OFF" on the remote display will be displayed and "TIMER" will be flicked. When you increase to press "ON/OFF" you will get desired time. Then, if pressing "ENTER/CANCEL" button, OFF TIMER Mode will be started. If you want to stop OFF TIMER Mode, please press "ENTER/CANCEL" again.

2. Press the TIMER OFF button once to enter the Timer screen.

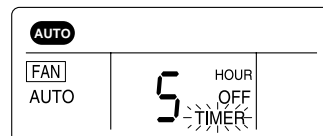
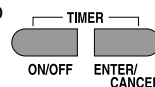

3. Repeatedly press the TIMER OFF button until the desired hour that you want the unit to shut off appears on the display. For example, if it is 8:00 P.M. and you want the unit to turn off at 10:00 P.M., select 2 hours.

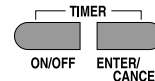

4. Press the ENTER button to input the setting into memory; the unit will beep, the TIMER indicator will light on the unit and the TIMER indicator on the remote will light to indicate the unit is in the timer mode.

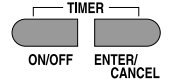

5. Place the remote controller so it is facing the unit. When the desired hour is reached, the unit will turn off.

NOTE: Press the ENTER button within 5 seconds of selecting the desired time. If more than 5 seconds elapse, steps 3 and 4 must be repeated.

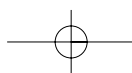
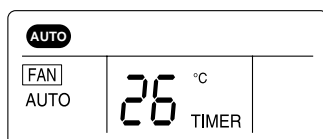

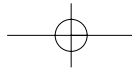

TO SET UNIT TO SLEEP MODE

When you are going to sleep, select this feature and the unit will cool off the room to the desired temperature and then increase that temperature throughout the night.

1. Press the ON/OFF button on the remote control to turn the unit on; the On LED will light on the indoor unit and "ON" will light in the remote display.



2. Press the MODE button to select the desired mode. Then, set the desired temperature using the TEMP. or MODE buttons.

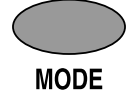

3. Press the SLEEP button on the remote controller. The unit will then be in the sleep mode and will cool the room to the desired temperature. After a while the unit will increase the temperature again. This process will then repeat.



TO CANCEL SLEEP MODE:

To cancel sleep mode, press the SLEEP button again; the SLEEP indicator will disappear in the display.

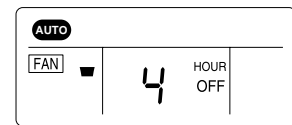

TO SET TURBO/MILD MODE

1. The unit is fixed "MILD" mode on production.
2. Press the "TURBO/MILD" button for powerful cooling.
3. When press the "TURBO/MILD" button one more time, it will be back to "MILD" mode.



EMERGENCY OPERATION

If the remote control is lost, broken or has no batteries, follow the procedures below:

1. Open the indoor unit's cover and make sure the EMERGENCY/REMOTE switch is set to the EMERGENCY position.

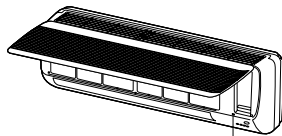

EMERGENCY/REMOTE Switch

2. The unit will then turn on and depending on the room temperature, it will select the cool or dehumidifier, fan speed and fan direction automatically.

3. To turn the unit off, slide the EMERGENCY/ REMOTE switch to the REMOTE position.

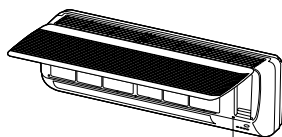

EMERGENCY/REMOTE Switch

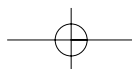

CHANGING/CLEANING THE AIR FILTERS

To change or clean the two black air filters, follow the procedures below:

1. Open the indoor unit's cover and remove both black air filters by bending them slightly backward and the lifting out.

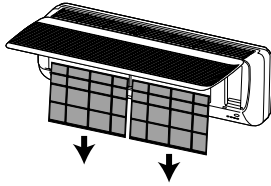

2. Remove the two small filters (Deodorizing and Electrostatic) from the indoor unit.

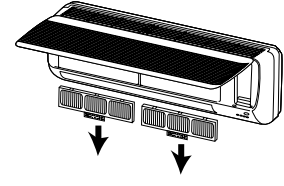

3. Examine the filters and determine if they need to be cleaned or replaced. To clean filters, use a vacuum and clean off dust. Use water and mild soap also if necessary.

4. Insert cleaned or new small filters (Deodorizing and Electrostatic) back into the unit.

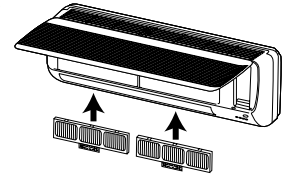

5. Insert cleaned or new black filters back into the unit.

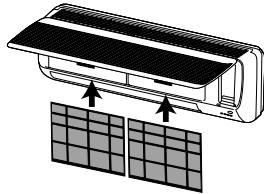

NOTES:

- The filters should be changed every 6 months. If in a climate with cold winters, once a year is adequate.
- After getting rid of vinyl in the filter (Deodorizing and Electrostatic), use it.

CLEANING THE INDOOR COVER

To clean the indoor cover, follow the procedures below:

1. Remove the left and right side to open the indoor cover upward by two hands.

NOTE: Please remove and insert the indoor cover by two hands.

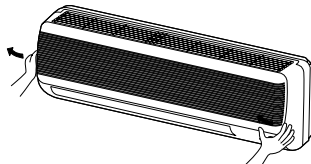

2. Pushing forward the indoor cover.

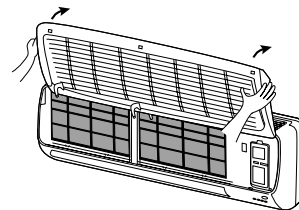

3. Remove the indoor cover.

(Remove it when cleaning.)

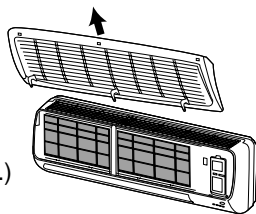

4. Cleaning the indoor cover.

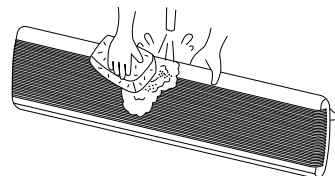

NOTES:

- Wipe the indoor cover with soft sponge or soft cloth.
- When cleaning up it in the state of opening the indoor cover, wipe it with soft cloth.
- After drying it completely in the shade, assemble it.
- If you do not so, it may cause a trouble.
- Reassemble the indoor cover is reverse process of assemble

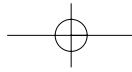

CARE AND MAINTENANCE



warning

- Make sure the AC cord is unplugged and the unit is off before cleaning.
- Do not use water on the unit to clean it. This is a shock hazard and the unit can be damaged.

Clean the casing and front of the indoor unit with a vacuum brush or wipe with a clean damp cloth.

- **NEVER USE** Solvents, harsh chemicals or hot water to clean the unit.
- Some metal edges on the unit are sharp. Be careful when cleaning or handling.
- Internal parts in the outdoor unit may need cleaning or routine maintenance from time to time. Consult your local service center for more details.

AFTER THE SEASON:

- Operate the fan, then dry the indoor unit.
- Shut off the indoor unit and then unplug it from the wall.
- Clean the air filters.
- Cover the outdoor unit with the supplied cover; this is very important to protect this unit.

BEFORE THE SEASON:

- Make sure the air filters are clean.
- Make sure the inlet and outlet on the indoor and outdoor units are not blocked by obstructions.
- Make sure the unit is grounded. Consult a serviceman for help.

PRECAUTIONS:

- Do not use this unit for animal or plant storage.
- In a lightning or thunder storm, immediately unplug it from the wall.

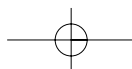

TROUBLESHOOTING GUIDE

Before requesting service, please refer to the chart below for possible solutions:

SYMPTOMS	POSSIBLE CAUSE	POSSIBLE SOLUTIONS
No power	Power failure.	Restore the power
	Line voltage too low.	Contact electrician to install new outlet.
	Unit is unplugged or not completely plugged in.	Insert plug all the way.
	Unit is off.	Turn unit on.
	Batteries in remote are weak or dead.	Replace remote's batteries.
	EMERGENCY/REMOTE switch is not set to REMOTE.	Slide EMERGENCY/REMOTE to REMOTE.
The compressor does not turn on. (no cool air)	When the unit is first plugged in and turned on, the compressor will delay turn on for 3 minutes.	Wait 3 minutes for the unit to operate.
	If the unit is turned off and then immediately back on, the compressor will delay for 3 minutes.	Wait 3 minutes for the unit to operate.
	The air filter(s) is dirty or clogged.	Clean or replace filter(s).
	Unit is located near a heat source (heater, stove, etc.)	When locating unit for the first time, make sure it is in a desirable location.
	A door or window is open.	Shut door or window.
	There is an obstacle in front of intake or indoor unit.	Remove obstacle.
	Thermostat is set too high.	Set thermostat lower.
Strange sounds occur.	During operation, especially after turning it on or off, refrigerant flows inside the unit.	This is normal.
Strange smells occur.	The fan is bringing out the smells of the carpet, walls, etc.	The smell should go away shortly.
No remote operation.	Batteries are weak, dead or inserted improperly.	Replace batteries.
	Remote is out of range.	Move closer to unit.
	Remote not aimed at sensor.	Aim remote at sensor.
	There is an obstruction between unit and remote.	Remove obstruction.

SPECIFICATIONS

MODEL		DSB-122L	DSB-122LH
Function		Cooling	Cooling / Heating (Heat pump)
Power Supply		AC 220-240V, 50Hz	
Cooling Capacity (Heating Mode)		3,024 Kcal/h	3,150 Kcal/h (3,402 Kcal/h)
Operating Current (Heating Mode)		5.7A	7.0 A (6.3 A)
Power Consumption (Heating Mode)		1,250W	1,500 W (1,410 W)
Indoor Unit Dimensions		W 925 x H 285 x D 194 mm	
Outdoor Unit Dimensions		W 666 x H 552 x D 264 mm	
Net Weight	Indoor	9.7 kg	
	Outdoor	34 kg	
Connection the piping	Type	Flare	
	Gas	1/2" (12.7 mm)	
	Liquid	1/4" (6.35 mm)	
Air Cleaning		Anti-bacteria Filter, Electrostatic Filter, Deodorizing Filter	
Operating Condition	Indoor side (Heating Mode)	min 21°C ~ max 32°C (min 15°C ~ max 27°C)	
	Outdoor side (Heating Mode)	min 21°C~max 52°C	min 21°C ~ max 43°C (min -5°C ~ max 24°C)

Design and specification are subject to change without notice for product improvement.

S/N.: 3103907000

Free Manuals Download Website

<http://myh66.com>

<http://usermanuals.us>

<http://www.somanuals.com>

<http://www.4manuals.cc>

<http://www.manual-lib.com>

<http://www.404manual.com>

<http://www.luxmanual.com>

<http://aubethermostatmanual.com>

Golf course search by state

<http://golfingnear.com>

Email search by domain

<http://emailbydomain.com>

Auto manuals search

<http://auto.somanuals.com>

TV manuals search

<http://tv.somanuals.com>