

# KW 85

- *Use and maintenance manual* . . . . .pag. 4
- *Mode d'emploi et d'entretien* . . . . .pag. 15
- *Instrucciones de uso* . . . . .pag. 28
- *Manual de instruções* . . . . .pag. 41
- *Istruzioni per l'uso* . . . . .pag. 54

KENWOOD

# Important safeguards

- Use this appliance only as described in this instruction manual.  
As with any electrical appliance, the instructions aim to cover as many eventualities as possible. Caution and common sense should be used when operating and installing this air conditioner.
- This appliance has been manufactured to cool and dehumidify domestic environments and should not be used for other purposes.
- It is dangerous to alter or modify the unit's characteristics in any way.
- The appliance must be installed in line with the relevant national legislation.
- Should repairs be necessary, contact the nearest authorized **De'Longhi Repair Service Center**. **Unauthorized De'longhi** servicing can be dangerous.
- This appliance is to be used by adults only; keep away from children.
- In the case that the power cord becomes damaged, this must be replaced only by specialized personnel authorized by the manufacturer.
- Always ensure the appliance is grounded. If you have any doubts check with a qualified electrician.
- Avoid using extension cords with the unit.
- Before cleaning or maintenance operations, always unplug the unit from the outlet.
- Do not pull on or place strain on the power cord when moving the appliance.
- The appliance should not be installed where the atmosphere may contain combustible gases, oil or sulphur, or near heat sources.
- Do not rest hot or heavy objects on the appliance.
- Clean the filters at least once a week.
- Avoid using heaters near the unit.
- The unit should be transported in a vertical position. If this is not possible secure the unit at an angle, do not lie it horizontally.
- Before transporting the unit, drain the condensation collecting-tray and tank. After transportation, wait at least 1 hour before switching on the unit.
- The packaging materials can be recycled. You are therefore recommended to place them in the special containers for differentiated waste collection.

**SAVE THESE INSTRUCTIONS**



# Introduction

The portable air conditioner is a compact unit for regulating air temperature and humidity. Its extremely flexible characteristics make it easy to use at any time and in any room. It can be operated in multiple modes including cooling, dehumidifying and ventilating. The appliance has been designed for domestic use and may be used in the home, office, etc.

It must be connected to an outlet with an impedance of less than 0.197 Ohms.

If necessary, consult your electricity supply company for information on impedance values.

## TIPS FOR ENERGY SAVING

- Keep blinds and/or curtains and windows closed during the sunniest hours of the day (cooling function).
- Keep the filter clean. In normal conditions, the filter should be cleaned about every 2 weeks. The filter eliminates part of the pollutant particles or dust transported in the air. Air quality thus depends on the frequency with which the filter is cleaned.

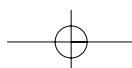
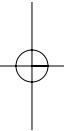
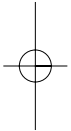

## Description

# Control panel

All functions of the unit can be controlled from the control panel or the remote control unit (certain models only).

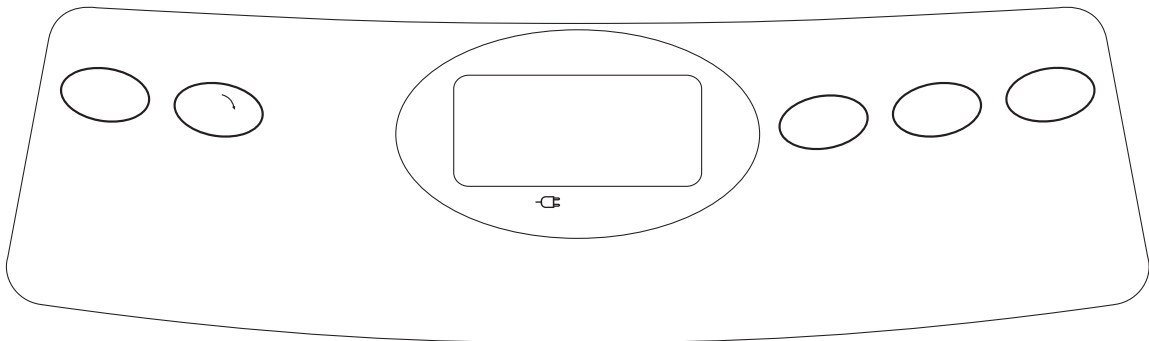

# Description

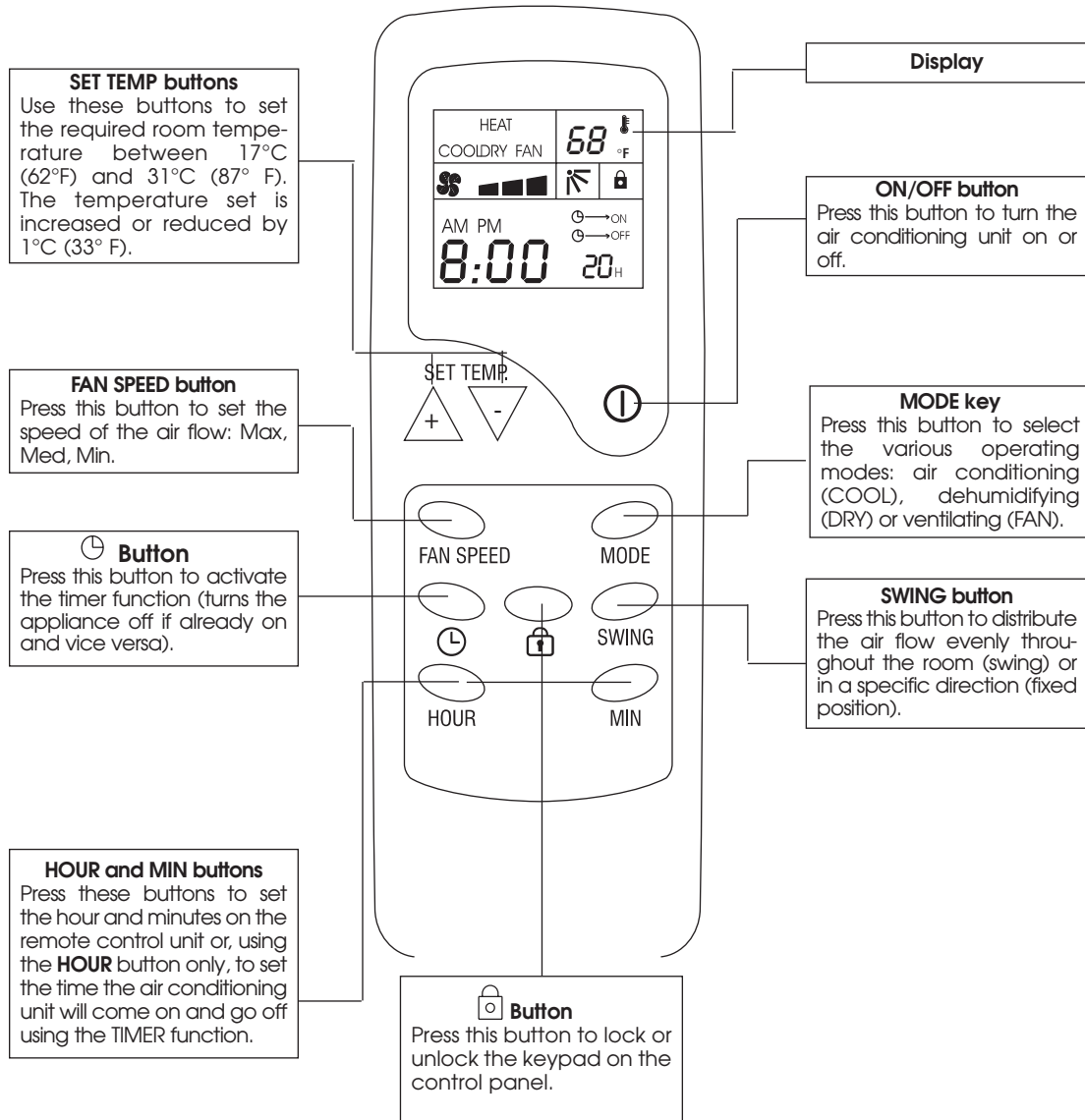

# Operation

## SETTING THE REMOTE CONTROL CLOCK

Remove the cover of the battery compartment on the back of the remote control unit. After inserting two 1.5 V alkaline batteries in the compartment, the clock is automatically set at 12:00. If you want to set the time to 10:30, proceed as follows:

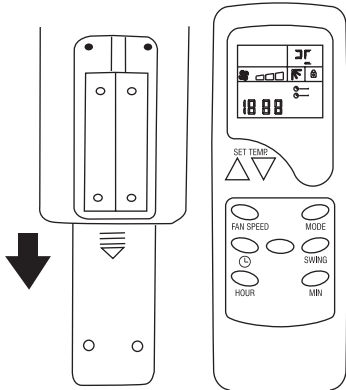

1

Press the **CLK** button (in the battery compartment) with a pointed object such as a pencil. The time indicator on the display flashes and the correct time can be set.

2

Press the **HOUR** button on the remote control unit to set the hours (set to 10 am).

3

Press the **MIN** button on the remote control unit to set the minutes (set to 30).

4

Press the **CLK** button again to confirm the operation, then replace the battery compartment cover.

## OPERATING RANGE

The operating range of the air conditioning unit goes from a minimum of +17°C (62°F) to a maximum of +35°C (95°F), with a choice of temperatures in cooling mode of from +17°C (62°F) to +31°C (87°F).

In dehumidifying mode, the operating range goes from +20°C (68°F) to +31°C (87°F). The temperature cannot be selected in advance.

## POWER SUPPLY

- Plug the air conditioning unit into a suitable outlet. Do not connect to multiple sockets.
- Once plugged into the outlet, wait about two seconds until you hear a beep, then press the "ⓘ" button to turn the appliance on.

## OPERATING IN AIR CONDITIONING MODE

1. Make sure the condensation tank is correctly in place.
2. Press the "**MODE**" button repeatedly until the air conditioning mode is selected. "COOL" appears on the display.  
While the unit is operating in air conditioning mode, always place the exhaust hose through an open window to eject the hot air from the room.

3. Press the "**SET TEMP**" button to set a suitable room temperature between +17°C (62°F) and +31°C (87°F).
4. Press the "**FAN SPEED**" button to select a suitable fan speed: Max, Med, Min.

## OPERATING IN DEHUMIDIFYING MODE

1. Keep the windows and door closed to make dehumidification of the room more efficient.
2. Make sure the condensation tank is correctly in place.
3. Repeatedly press the "**MODE**" button to select the dehumidifying mode. "DRY" appears on the display.
4. Neither the fan speed nor temperature can be regulated.
5. Do not use the exhaust hose to expel the air outside. The hot air given out at the back of the appliance should not be expelled from the room.

# Operation

## TIMER FUNCTION

When the air conditioning unit is off (but plugged into the outlet), to turn it on at the required time press the "TIMER ON/OFF" button ("☉→ON" will appear on the display), then press the "TIMER HOUR" button until the number of hours to elapse before the appliance comes on appears on the display. Vice versa, when the air conditioning unit is on, to turn it off at the required time press the "TIMER ON/OFF" button ("☉→OFF" will appear on the display), then press the "TIMER HOUR" button until the number of hours to elapse before the appliance goes off appears on the display. The timer can be set from one to 12 hours.

## AUTOMATIC SWING FUNCTION

Press the "SWING" button once. The fins will swing, distributing the air flow in the room. Press the button again, the flow will be steady in one direction.

## CHILD SAFETY

Pressing the "+" and "-" buttons on the control panel together for more than two seconds locks the keypad.

The "🔒" symbol appears on the LCD display. The same keypad lock function can be activated on the remote control unit by pressing the "🔒" button.

To unlock, repeat the operation.

## BEFORE USING THE APPLIANCE

1. If the appliance has been in a horizontal position during storage or transport, you are recommended to wait at least three hours before turning it on.
2. Always position the air conditioning unit on a stable surface.
3. Attach the air exhaust hose to the air conditioning unit.
4. Plug the air conditioning unit into a suitably rated outlet.
5. Set the various functions of the air conditioning unit according to your requirements.
6. The cooling system will shut down when room temperature drops below the set temperature. The fan will, however, continue to operate at the set speed. If the room temperature rises above the temperature set, the cooling system comes on again automatically.



# Installation

## CHOOSING THE INSTALLATION SITE

Position the air conditioning unit on a flat surface where the air outlet grilles cannot be obstructed. Position the appliance at least 50 cm (19.7") away from walls or obstacles.

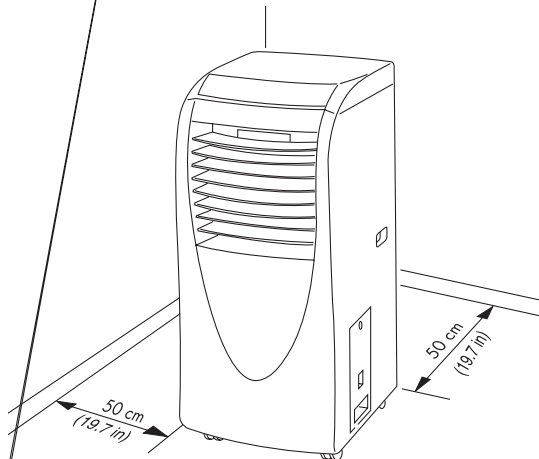

## CABLE WINDER

Before installing the air exhaust hose, mount the two cable winder brackets using the screws supplied as shown in the figure.

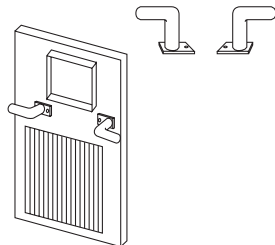

## AIR EXHAUST ACCESSORIES

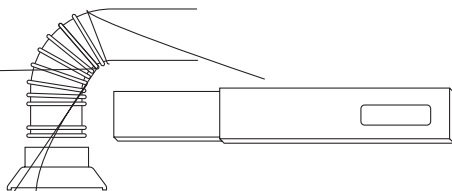

## INSTALLING THE AIR EXHAUST HOSE

1. Open out the end of the hose and screw the two adapters on counterclockwise (see figure).
2. Fit the square adapter on the air exhaust hose to the air exhaust outlet on the appliance.
3. Connect the other end (flange) to the nearest window.

Important: the air exhaust hose must be between 500 mm (19.7") and 2000 mm (78.7") long. You are recommended to keep the air exhaust hose as short as possible.

During installation, keep the hose as horizontal as possible without distorting it. Do not connect the terminal to other exhaust ducts (flue

or chimney) as this could lead to malfunction.

Correct wall installation: the hole must be at a height of between 40 cm (15.7") and 130 cm (51.18") from the floor.

# Installation

If the flange hose must be curved to expel the air, you should follow the measurements given in the figure:

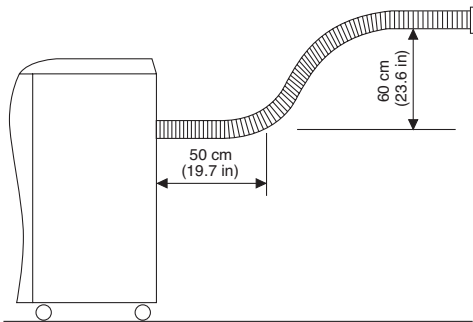
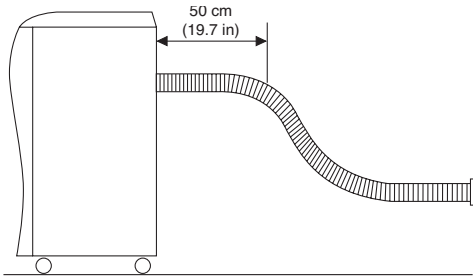

Incorrect installation diagram (the bend in the hose is excessive and could easily lead to malfunction)

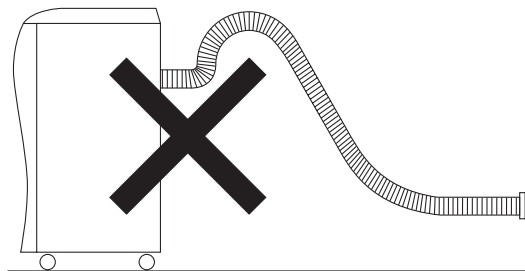

## MOUNTING THE ADJUSTABLE WINDOW CLOSURE CROSSPIECE (only on some models)

The appliance is provided with an adjustable bracket.

If you have a sliding window, position the crosspiece in the window frame, extend it completely then close the window onto the crosspiece. Fit the window flange onto the end of the air exhaust hose, position it on the hole in the crosspiece, then fit the other end of the hose onto the back of the air conditioning unit.

This considerably reduces heat dispersion due to contact between the room and the outside environment.

The crosspiece is 40 mm (1.5") wide and between 675 mm (26.7") and 1230 mm (48.4") long.

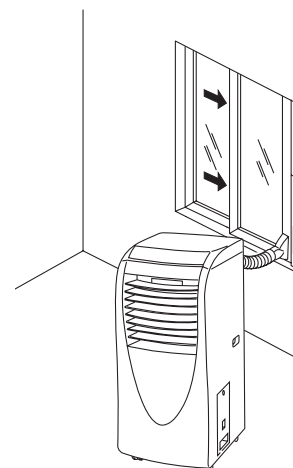
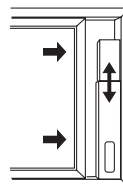
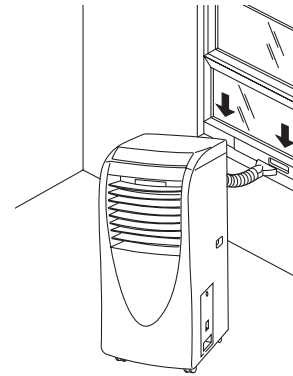
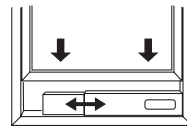

# Installation

## CONDENSATION DRAINAGE

When the air conditioning unit is operating in air conditioning or dehumidifying mode, the condensation is collected in a special tank. When the tank is full, the "tank full" indicator light on the control panel flashes.

Remove the condensation tank, empty and replace on the unit as shown in the following figures.

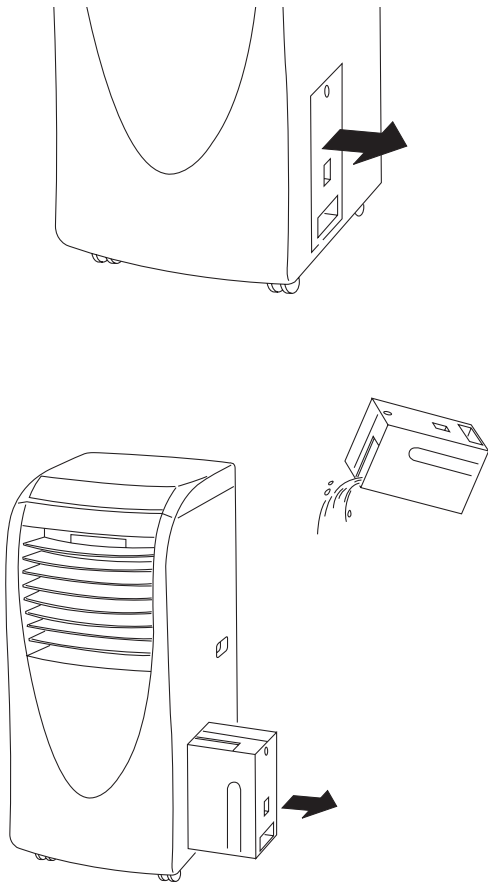

- Do not remove the cap of the tube in the water tank compartment (present in certain models only) while the unit is operating with condensation collecting in the tank as this could lead to leaks of water.

## CONTINUOUS CONDENSATION DRAINAGE

To drain condensation continuously without the air conditioning unit shutting down, proceed as follows (models designed for continuous condensation drainage only):

- Pass the tube in the tank compartment through the hole in the tank (see figure).
- Remove the cap from the tube and connect it to an external pipe (not provided) able to drain the condensation continuously.

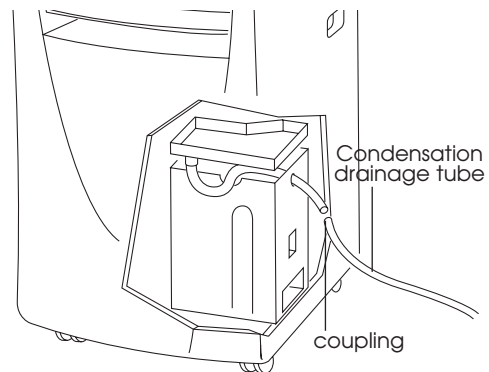

## Attention

- While the air conditioning unit is operating in air conditioning or dehumidifying mode, do not extract the condensation tank before it is full, otherwise a buzzer will sound indicating that the compressor has stopped. The unit will switch to FAN mode.
- To remove the tank before it is completely full, the unit must be stopped by turning it off or operating it in FAN mode only, waiting about three minutes to avoid the condensation dripping outside the tank, then removing the tank.

# Maintenance

## MAINTENANCE

- Turn the appliance off and unplug from the outlet before cleaning.
- Make sure the unit is disconnected from all voltage before proceeding with maintenance. This avoids the risk of electric shock.
- Never use chemical solvents (such as benzene and alcohol) to clean the surface of the unit. This could scratch or damage the surface or even distort the external part.
- Use water with delicate detergents or a soft cloth only to clean or dry plastic parts.
- To clean the condensation tank, remove and completely empty it of water. Clean with neutral detergents, rinse and dry thoroughly. Then replace in the original position.

## AIR FILTER

If the air filter is blocked by dirt or dust, the flow of air diminishes, reducing the performance of the appliance and leading to malfunction. The air filter must be cleaned and/or washed at least once every two weeks.

1. Open the air filter holder grille by pulling it towards the outside.
2. Remove the filter from the filter holder grille.
3. Wash the air filter by immersing it delicately in warm water (no more than 40° C) (104°F) with neutral detergent, rinse and dry completely in the shade.
4. Replace the dry filter in the grill, fastening it with the pins on the inside surface of the grille.
5. Replace the grille on the unit.

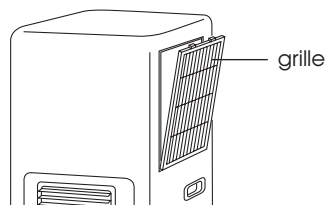

## END OF SEASON PROCEDURE

1. Turn the appliance off and disconnect from the outlet by unplugging from the outlet.
2. In models with a continuous condensation drain tube only, before emptying the condensation from the tank, remove the cap from the plastic tube to enable water in the tube to flow into the tank, then operate the unit in fan mode for half a day to ensure that the inside of the unit is completely dry.

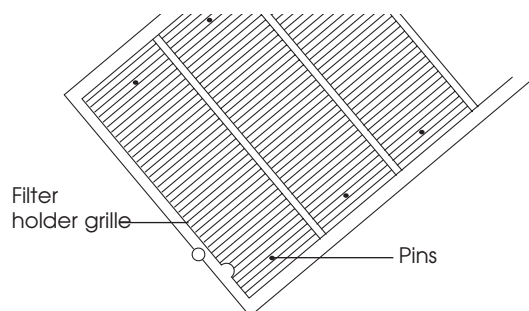

3. Empty the condensation water from the tank, clean and dry
4. Wind the power cable around the cable winder, then cover the appliance with a cover or bag and store in a dry place.

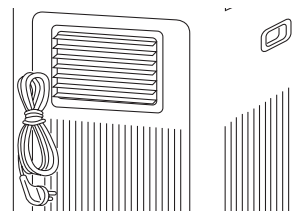
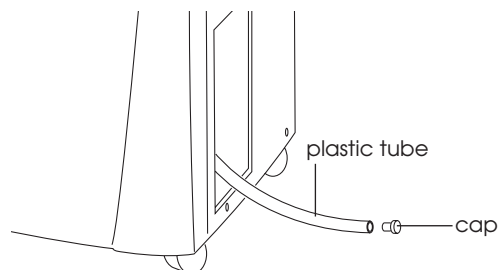

# Troubleshooting

Before contacting an authorized technical service center, check the following:

Problem	Check	Solution
The appliance does not work.	<ul style="list-style-type: none"> <li>• If there is a power outage</li> <li>• If the plug is not correctly inserted in the outlet</li> <li>• If the outlet switch or the switch on the air conditioning unit is off.</li> <li>• If the condensation tank indicator light is on.</li> <li>• If the condensation tank is positioned correctly</li> </ul>	<ul style="list-style-type: none"> <li>• Check it no longer occurs</li> <li>• Plug into the outlet</li> <li>• Check the outlet switch or turn the air conditioning unit switch on</li> <li>• Empty the water in the tank</li> <li>• Position the condensation tank correctly</li> </ul>
The appliance does not cool satisfactorily	<ul style="list-style-type: none"> <li>• If the air intake and outlet grilles are blocked</li> <li>• If there are other sources of heat in the room</li> <li>• If the air filter is very dirty</li> <li>• If the temperature set (SET TEMP) is not correct</li> <li>• If the internal fan speed is on slow</li> </ul>	<ul style="list-style-type: none"> <li>• clean and free from obstructions</li> <li>• move the heat source</li> <li>• clean the air filter</li> <li>• set the temperature</li> <li>• set the fan speed correctly</li> </ul>
There is excessive noise and vibration	<ul style="list-style-type: none"> <li>• It is caused by the refrigerant fluid running through the tubes</li> <li>• Is it sloping?</li> </ul>	<ul style="list-style-type: none"> <li>• This is normal</li> <li>• Place the appliance in a horizontal position</li> </ul>
The unit shuts down or starts up frequently	<ul style="list-style-type: none"> <li>• Is the air expelled through the exhaust hose correctly or does the hose follow a correct path?</li> <li>• Other exhausts have been connected together on the same hose</li> </ul>	<ul style="list-style-type: none"> <li>• Try and keep the air exhaust hose in as horizontal a position as possible to facilitate evacuation of the air.</li> <li>• Do not use other exhaust hoses, always use the hose supplied to expel the air.</li> </ul>

## Limited Warranty

De'Longhi is the distributor of Kenwood home appliances.  
This warranty applies to all home appliances with De'Longhi or Kenwood brand names.

FOR CONTIGUOUS UNITED STATES ONLY

### Limited Warranty

We warrant each De'Longhi AIR CONDITIONER to be free from defects in material and workmanship. From the purchase date, our obligation under this warranty is to provide one (1) year free parts and labor on the entire AIR CONDITIONER, with an additional four (4) years free on any part of the sealed system consisting of the compressor, evaporator, condenser and factory connected refrigerant tubing. Labor and all other parts during the additional four (4) year warranty are to be paid by the owner. All AIR CONDITIONERS in need of repair are to be shipped to an authorized De'Longhi service center at the owner's expense, and De'Longhi will then incur the return shipping costs. After the first five (5) years of ownership, all expenses (all parts, labor and shipping) are to be paid by the owner of the unit. This warranty shall apply only if the AIR CONDITIONER is used in accordance with the factory directions that accompany it, and on an Alternating Current (AC) circuit. This warranty is in lieu of all other warranties and representations, expressed or implied, and all other obligations or liabilities on our part. We do not authorize any other person or company to assume for us any liability in connection with the sale or use of our AIR CONDITIONER. This warranty shall not apply to any AIR CONDITIONER that has been repaired or altered outside our factory nor shall it apply to any AIR CONDITIONER that has been subjected to misuse, negligence or accidents.

If repairs become necessary, see contact information below:

#### **U.S. Residents:**

Please contact our toll free hotline at 1-800-322-3848 or log onto our website at [www.delonghi.com](http://www.delonghi.com).

For all accessories, spare parts or replacement parts, please contact our parts division at 1-800-865-6330.

#### **CANADA Residents:**

Please contact our toll free hotline at 1-888-335-6644 or log onto our website at [www.delonghi.com](http://www.delonghi.com).

#### **Other countries:**

Please visit: [www.delonghi.com](http://www.delonghi.com).

## Free Manuals Download Website

<http://myh66.com>

<http://usermanuals.us>

<http://www.somanuals.com>

<http://www.4manuals.cc>

<http://www.manual-lib.com>

<http://www.404manual.com>

<http://www.luxmanual.com>

<http://aubethermostatmanual.com>

Golf course search by state

<http://golfingnear.com>

Email search by domain

<http://emailbydomain.com>

Auto manuals search

<http://auto.somanuals.com>

TV manuals search

<http://tv.somanuals.com>