

OWNERS' MANUAL

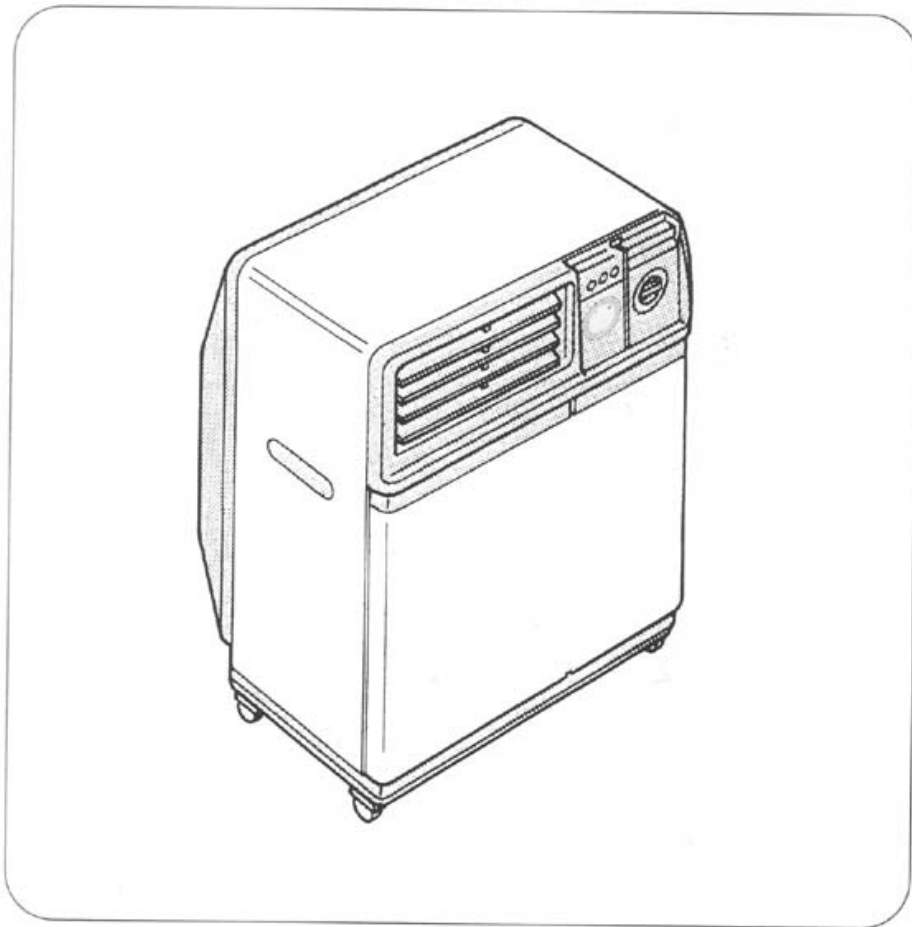

PAC 02 U Portable Windowless Air-Conditioner



IMPORTANT: NOTE MAINTENANCE NEEDS ON PAGE 11



IMPORTANT INFORMATION

When using electrical appliances, basic safety precautions should always be followed, including the following:

- Read all instructions.
- To protect against fire, electrical shock and personal injury, do not immerse cord, plug or appliance in water or other liquid.
- Close supervision is necessary when any appliance is used by or near children.
- Do not operate with a damaged cord or plug, or after the appliance malfunctions, or has been damaged in any manner. Return the appliance to the nearest authorized service facility for examination, repair or adjustment.
- The use of accessory attachments or spare parts not recommended by the appliance manufacturer may result in fire, electrical shock or personal injury.
- Do not use outdoors.
- Do not use the appliance for other than the intended use.
- Do not place any strain on the power cord. Avoid twisting and/or tangling.
- Ensure that outlet vent of exhaust hose is kept clear and obstruction free.
- Ensure that ventilation holes on the rear of the machine and front louvers are not blocked.
- The Pinguino should not be installed where the atmosphere could contain combustible gases.
- Avoid using Pinguino in oily or sulphurous atmospheres or near sources of heat.
- Wait at least 3 minutes before restarting, after the air-conditioner has been switched off or the thermostat setting changed.
- Before moving the air-conditioner, empty water from collecting tray . After transportation, wait at least 1 hour before switching on appliance
- Do not place hot or heavy objects on the appliance.
- Clean air filter every week (see instructions at page 12).
- **Important:** If you need to use an extension cord, please be sure to use a **heavy duty** extension cord (minimum 14 gauge).

SAVE THESE INSTRUCTIONS

Dear user,

We thank you for purchasing the Pinguino air-conditioner and congratulate you on your wise choice.

For optimal results please read this manual carefully before installing or operating.

We know that the Pinguino will maintain your environment pleasingly comfortable at all times.

With best wishes

De Longhi S.p.A.

If you have any questions about the operation or service of your Pinguino, please call our toll-free service number 1-800-322-3848.

SPECIFICATIONS			
Power supply voltage	V	see rating label	
Frequency	Hz	60	
Cooling capacity: (*)		see rating label	
Fan speeds	W	2	
Max. air flow capacity		360 cu.m/h	
Dehumidification quotient (*)		see rating label	
Dimensions:	width	in. (mm)	22 ¹ / ₃₁ (560)
	height	in. (mm)	30 (735)
	depth	in. (mm)	15 ⁹ / ₁₆ (390)
Net weight	lb. (kg)	97 (44)	
*Data according to pending standard testing procedures subject to review by the U.S. Dept. of Energy.			

115 V VERSION IS UL APPROVED

A HE (High efficiency) system with low energy consumption has been installed on this appliance. Such system needs about 4 minutes, once the appliance has been started, to produce cold air.





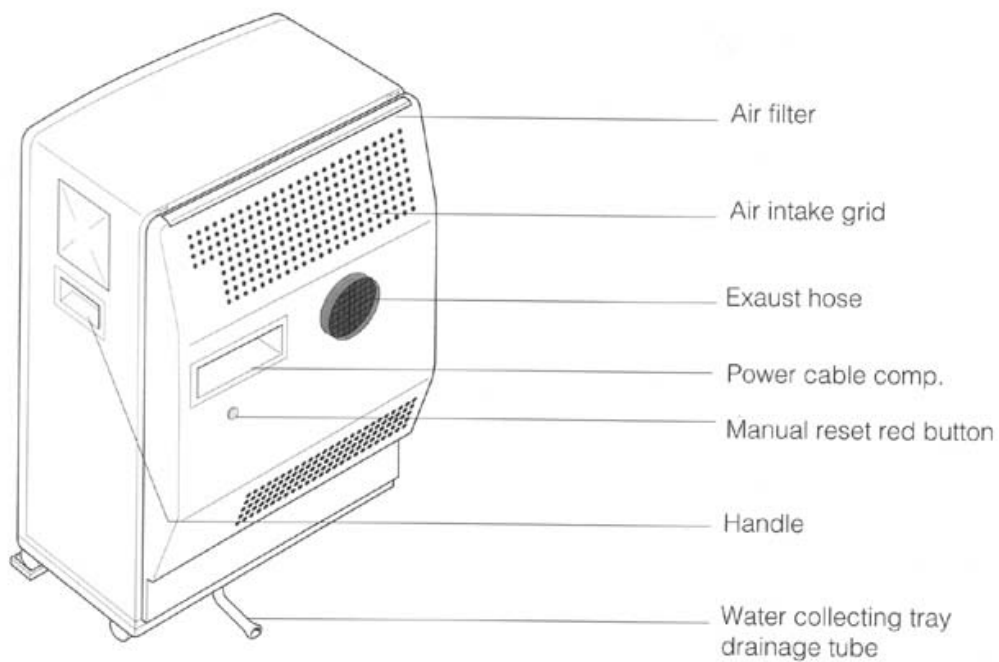
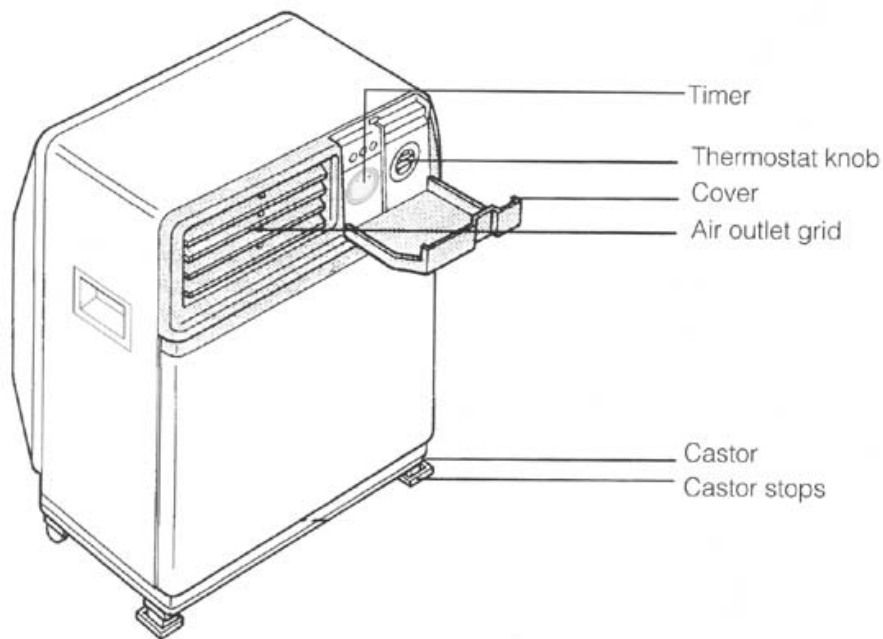

OPTIMUM OPERATING RANGE

ROOM TEMPERATURE	70°F-90°F (21°C - 32°C)
ROOM HUMIDITY FACTOR	≤ 80%

ILLUSTRATED MAIN FEATURES LIST



ILLUSTRATED ACCESSORY LIST

	DESCRIPTION	SUPPLIED
	Exhaust hose	1
	Stopper + flange	2
	Caster stop	2
	Window nozzle	1
	Suction pad	2
	Adjustable window bracket	2

ACCESSORY CHECK

Check that all parts listed in Table above are included.

PERMANENT INSTALLATION

The Pinguino accessories include two sets of flanges and stoppers, to be mounted in different locations (two different rooms).

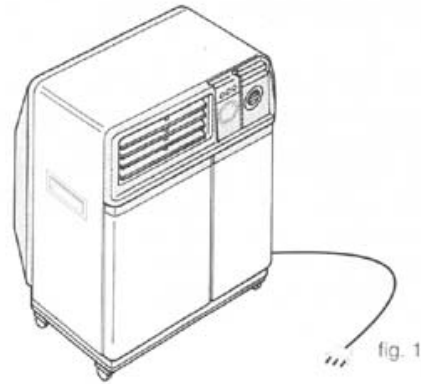

Permanent installation outlet holes must be in an exterior wall and opening diameter should not exceed 3¹/₂.

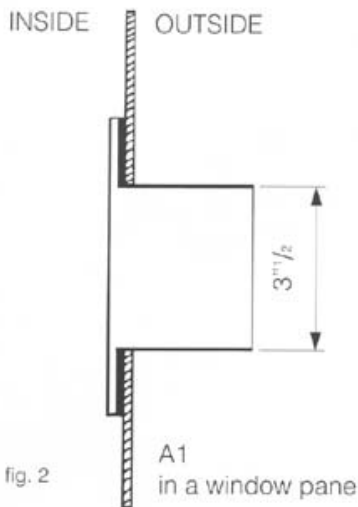

fig. 2

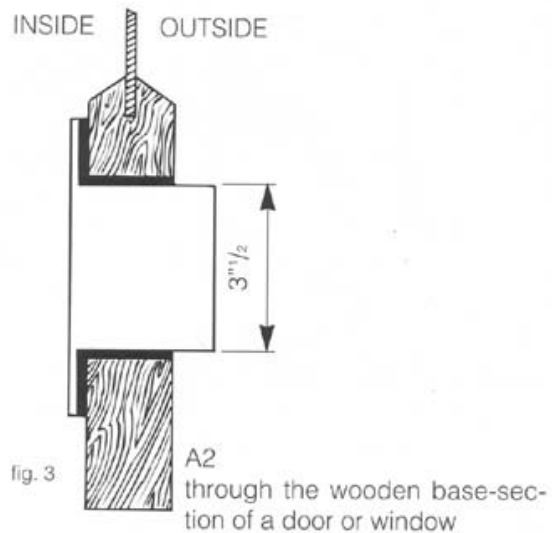

fig. 3

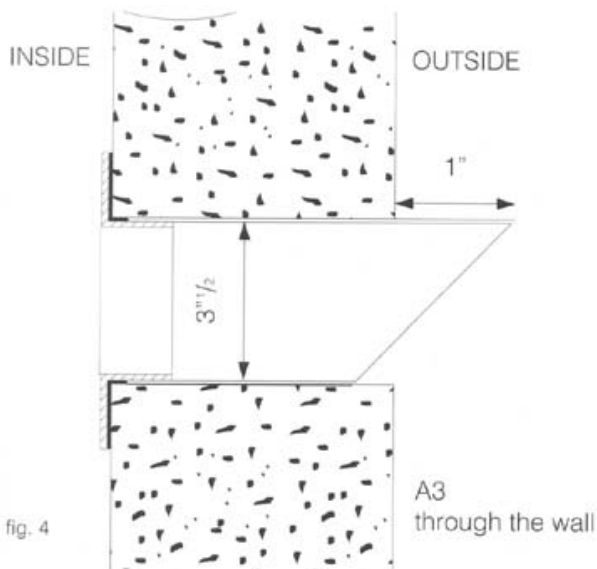

fig. 4

In case of permanent installation, air discharged from rear hose has been extracted from the room where the appliance is installed.

Check that the room (especially if small) is not "air-tight"; a drop in pressure would cause irregular functioning, which could consequently activate reset switch. Air entering through door and window cracks is normally sufficient. If deemed, necessary leave a door ajar (approx. 1 cm is enough).

TEMPORARY INSTALLATION

Note: In both cases (permanent and temporary installations) make sure that the Pinguino is positioned on level ground. If necessary use the two caster stops for the front casters

A temporary installation makes it easy to use Pinguino in any room, provided there is a window or a door: it allows you to use the Pinguino immediately.

Suction pad may be used to keep window or door closed.

In any case, for maximum cooling efficiency the window should be closed as much as possible.

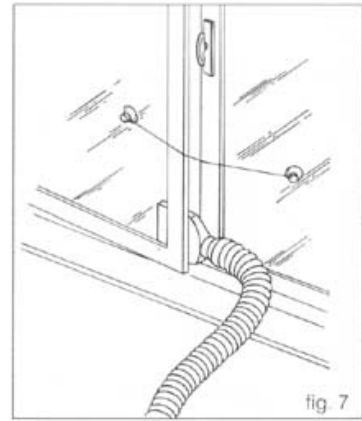
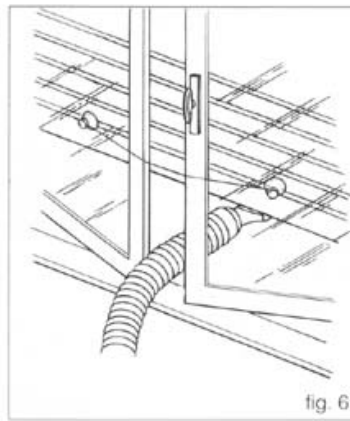

SET UP INSTRUCTION

For permanent installation place the Pinguino near the outlet opening in wall or window (where it is meant to be used). The diagram below shows the correct way to install the exhaust hose.



ELECTRICAL CONNECTION

Check that the power supply voltage correspond to the voltage shown in the rating label.

Important: if you need to use an extension cord, please be sure to use a **heavy duty** extension cord (minimum 14 gauge).

Before connecting the Pinguino to power supply, make sure that all switches on the front control panel are in the OFF position.
Remove power cord found in storage compartment at rear of the air-conditioner and plug into wall socket.

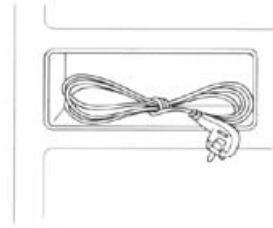

fig. 9

FINAL CHECK

In order to obtain the maximum performance from your air-conditioner make sure that:

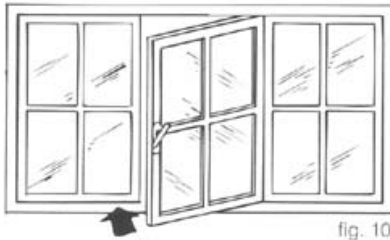

fig. 10

- Doors and windows of room to be air-conditioned are closed (with the exception of temporary installation where a partially opened window is necessary).

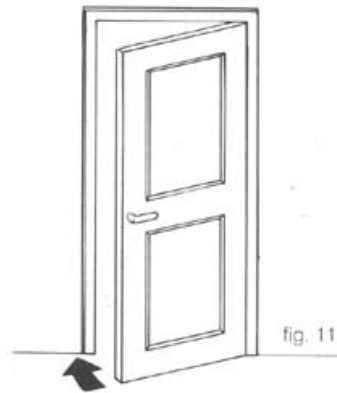

fig. 11

Close the doors

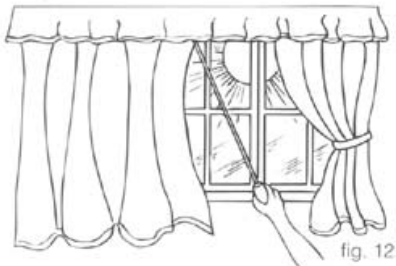

fig. 12



fig. 13

- Shade the room as far as possible from direct sunlight by drawing curtains and/or lowering blinds or shutters, for economical and efficient air-cooling.
- Ensure that intake and outlet vents are not blocked.
- Make sure there are no sources of heat in the room.

CONTROL PANEL

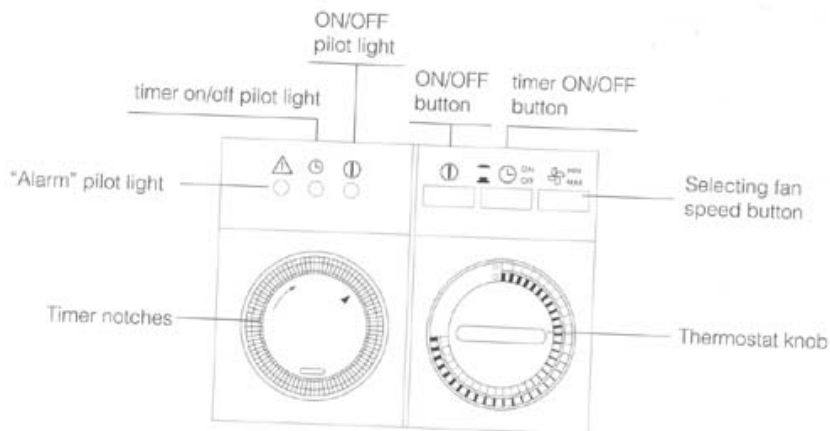

SETTING THE TIMER

The programmer/timer, like all clocks, must be set to the exact time. If for example it is 4.00 p.m., turn the dial in a clockwise direction (following the direction of the arrow) until the number 4 is lined up with the arrow pointer (the arrows indicates 4:00 p.m. approximately).



Note: Never turn the dial in an anti-clockwise direction!

The timer is in effect, an electric clock and works only if the plug is connected to the power supply. Whenever the plug is disconnected or there is a power failure, the programmer stops (the clock is then "slow") and must be re-set.

The unit can be used in either **programmed** or **non-programmed** mode.

AIR-CONDITIONING

1. Press the ON-OFF button ① to start the appliance.
2. Set thermostat knob at max. cold.
3. Choose desired temperature. For universal consumer convenience, the temperature is shown by spaced marks rather than in degrees. It is recommended that the thermostat be placed on max. cold until room temperature has reached the desired level of comfort, then slowly turn the thermostat knob clockwise until the thermostat shuts off the compressor while ventilation continues. In so doing, you will have programmed your appliance on to this exact level of comfort which the thermostat will automatically maintain. After an initial period of use, consumers will be able to judge immediately the required setting for reaching the temperature desired in a room.

SWITCHING OFF

1. To turn the the appliance off, press ON/OFF button ①

PROGRAMMED MODE

- 1) Press the timer ON/OFF button.
- 2) Set the operating times by pushing out the notches on the dial corresponding to the period required (each notch represents 15 mins.).
- 3) Check that the timer indicates the correct time (see instructions on setting).

The unit will now switch on and off each

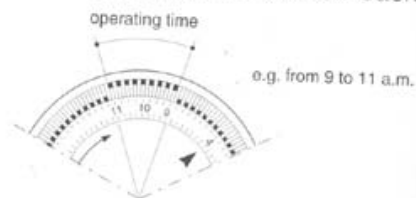

day at the selected times.

Note: To override the programmed operating times, simply release the ON/OFF key.

NON-PROGRAMMED MODE

- 1) TIMER ON/OFF button must be released

With the appliance on cooling, air humidity in the room is automatically reduced and condensate eliminated through the exhaust hose.

MAINTENANCE

PRECAUTIONS

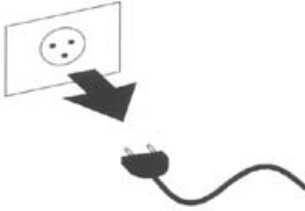

fig. 14

During cleaning and normal maintenance operations remember to disconnect plug.



fig. 15

Under no circumstances should appliance be washed with running water. Damage could be caused to the electrical circuit.

CLEANING OF EXTERNAL HOUSING



fig. 16

Clean with a damp cloth and dry thoroughly with a clean dry cloth.



fig. 17

Use only mild soap and water.
Do not use chemical cleaners.

CONTROLS AT THE BEGINNING OF THE SEASON



Carefully follow installation procedure.

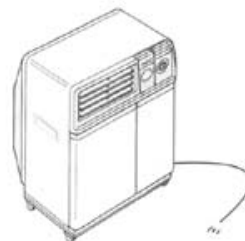

Check for any defects in power cord and plug.

fig. 18

AIR FILTER CLEANING

Maintenance of air filter

A clogged air filter reduces the quantity of circulating air and the efficiency of the appliance. Clean filter every week using a vacuum cleaner.

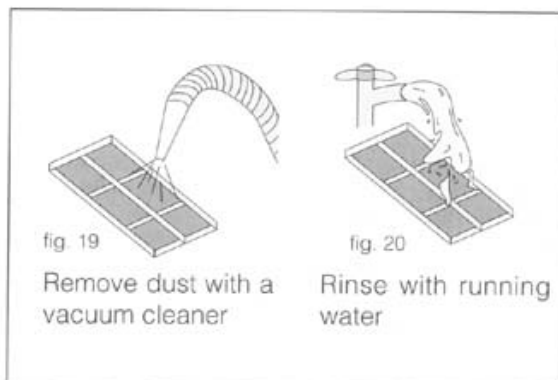

Removal and replacement of air filter

Gently pull filter upwards.
Push down to replace.



fig. 21

Cleaning procedure

To remove dust deposited on filter, use a vacuum cleaner. If it is very dirty, soak in lukewarm water and rinse thoroughly. The temperature of the water must be kept below 104°F (40°C). After washing, leave filter to dry before replacing.

END OF SEASON OPERATIONS



fig. 22

- 5) Cover appliance with a polyethylene bag to prevent dust from entering. You can use the polyethylene bag included into the packaging.



fig. 23

- 1) Disconnect plug.
- 2) Remove plug from drainage tube, to empty water collecting tray.
- 3) Remove exhaust hose.
- 4) Clean filter and dry well before replacing.

TROUBLESHOOTING

PROBLEMS	CAUSE	SOLUTION
The Pinguino does not work:	<ul style="list-style-type: none">- power failure- plug is disconnected- ON/OFF switch is off- Timer button is in ON position	<ul style="list-style-type: none">- insert plug- switch on- release the TIMER key
The appliance functions for only brief periods because reset switch activates	<ul style="list-style-type: none">- exhaust hose blocked- exhaust hose twisted or bent- ventilation holes on the rear of the machine or front louvers blocked- condenser fan has jammed- safety ball cock has activated	<ul style="list-style-type: none">- Check for obstruction of air outlet vent- eliminate irregularities- remove obstacles to allow proper airflow- Call Service Centre- Drain off condensate water through drainage tube
ON/OFF switch keeps activating		<ul style="list-style-type: none">- Turn off and call Service Centre
The Pinguino produces cold air but room does not maintain comfortable temperature:	<ul style="list-style-type: none">- window open- air exhaust hose has become disconnected- thermostat set too low- air filter blocked- source of heat in room (heater, lamp, etc.) or room is overcrowded with people	<ul style="list-style-type: none">- close window- re-insert exhaust hose- set thermostat to higher number- clean filter- remove source of heat

SERVICING

In case of malfunction turn off and disconnect the Pinguino from power outlet and contact our Service Centre for qualified assistance, toll-free number 1-800-322-3848. (Should troubleshooting checklist fail to remedy malfunction, manufacturer does advise customers against unqualified servicing).

DeLonghi

LIMITED WARRANTY

We warrant each DE'LONGHI AIR-CONDITIONER to be free from defects in material and workmanship. Our obligation under this warranty is to provide one year parts and labor free from purchase date, with an additional four (3) years on any part of the sealed system consisting of the compressor, evaporator, condenser and factory connected refrigerant tubing. This warranty shall apply only if the AIR-CONDITIONER is used in accordance with the factory directions which accompany it, and on Alternating Current (AC) circuit. This warranty is in lieu of all other warranties and representations, expressed or implied, and all other obligations or liabilities on our part. We do not authorize any other person or company to assume for us any liability in connection with the sale or use of our AIR-CONDITIONER. This warranty shall not apply to assume for us any liability in connection with the sale or use of our AIR-CONDITIONER. This warranty shall not apply to any AIR-CONDITIONER which shall have been repaired or altered outside our factory nor shall it apply to any AIR-CONDITIONER which has been subjected to misuse, negligence or accidents. If repairs become necessary or spare parts are needed, please write to:

SERVICE
PH. N° 1-800-322-3848

DE'LONGHI AMERICA INC.
625 WASHINGTON AVENUE
CARLSTADT, NJ 07072

Free Manuals Download Website

<http://myh66.com>

<http://usermanuals.us>

<http://www.somanuals.com>

<http://www.4manuals.cc>

<http://www.manual-lib.com>

<http://www.404manual.com>

<http://www.luxmanual.com>

<http://aubethermostatmanual.com>

Golf course search by state

<http://golfingnear.com>

Email search by domain

<http://emailbydomain.com>

Auto manuals search

<http://auto.somanuals.com>

TV manuals search

<http://tv.somanuals.com>