

Pinguino

PAC260

Use and maintenance manualpage 2

Mode d'emploi et d'entretienpage 16

Instrucciones de usopágina 29

Istruzioni per l'usopagina 43

Belonghi

Important Safeguards

When using electrical appliances, basic safety precautions should always be followed, including the following:

- Read all instructions.
- To protect against fire, electrical shock and personal injury, do not immerse cord, plug or appliance in water or other liquid.
- Close supervision is necessary when any appliance is used by or near children.
- Do not operate with a damaged cord or plug, or after the appliance malfunctions, or has been damaged in any manner. Return the appliance to the nearest authorized service facility for examination, repair or adjustment.
- The use of accessory attachments or spare parts not recommended by the appliance manufacturer may result in fire, electrical shock or personal injury.
- Do not use outdoors.
- Do not use the appliance for other than the intended use.
- Do not place any strain on the power cord. Avoid twisting and/or tangling.
- Ensure that outlet vent of exhaust hose is kept free of debris and obstruction.
- Ensure that ventilation holes on the rear of the machine and front louvers are not blocked.
- The Pinguino should not be installed where the atmosphere could contain combustible gases.
- Avoid using Pinguino in oily or sulphurous atmospheres or near sources of heat.
- Wait at least 3 minutes before restarting, after the air conditioner has been switched off or the thermostat setting changed.
- Before moving the air conditioner, empty water from collection tray (see instructions for drainage at page 13).
- Do not place hot or heavy objects on the appliance.
- Clean air filter every week (see instructions at page 13).
- **Important:** If you need to use an extension cord, please be sure to use a **heavy duty** extension cord (minimum 14 gauge).

SAVE THESE INSTRUCTIONS

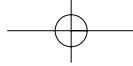

Dear user,

We thank you for purchasing the Pinguino air conditioner and congratulate you on your wise choice.

For optimal results please read this manual carefully before installing or operating.

We know that the Pinguino will maintain pleasingly comfortable environment at all times.

With best wishes,

De Longhi S.p.A.

If you have any questions about the operation or service of your Pinguino, please call our toll-free service number 1-800-322-3848.

or visit our internet site:

www.delonghiusa.com

for general overlook of De'Longhi group visit:

www.delonghi.com

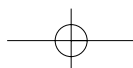

Specifications

Power supply voltage	V	see rating label
Frequency	Hz	60
Cooling capacity: (*)		see rating label
Fan speeds		2
Dehumidification quotient (*)		see rating label
Dimensions:	width in. (mm) height in. (mm) depth in. (mm)	22 ^{1/31} (560) 30 (735) 15 ^{9/16} (390)
Net weight	lb. (kg)	97 (44)
*Data according to pending standard testing procedures subject to review by the U.S. Dept. of Energy.		

A HE (High efficiency) system with low energy consumption has been installed on this appliance. This system needs about 4 minutes, once the appliance has been started, to produce cold air.

OPTIMUM OPERATING RANGE



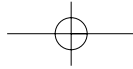

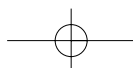
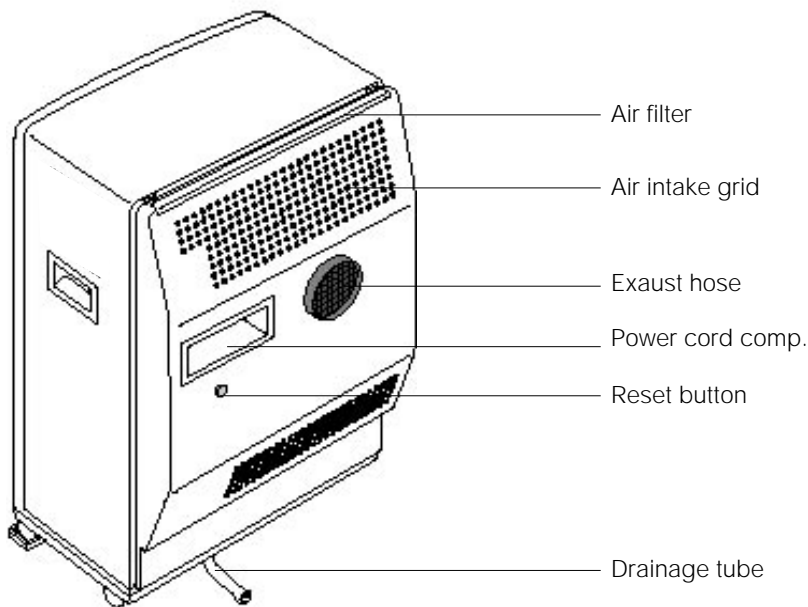
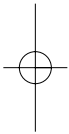
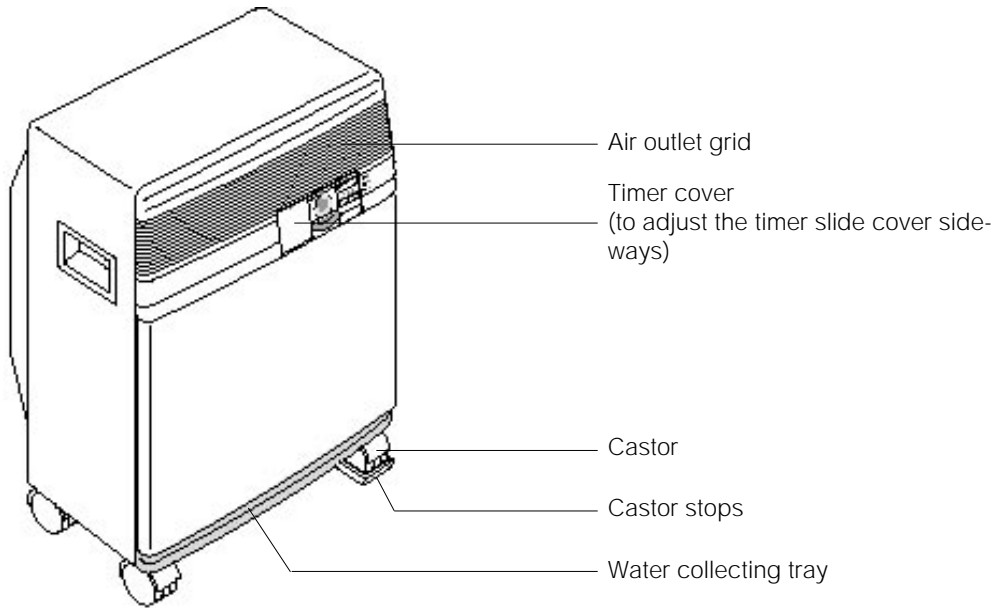

ROOM TEMPERATURE		70°F - 90°F
ROOM HUMIDITY FACTOR		50% - 80% RH
POWER SUPPLY	FREQUENCY	60 HZ
	VOLTAGE	115V



Illustrated main features list

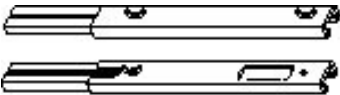

Accessories

	DESCRIPTION	SUPPLIED
	Exhaust hose	1
	Stopper + flange	1
	Caster stop	2
	Window nozzle	1
	Adjustable window and door bracket	1
	Suction disc	2

ACCESSORY CHECK

Check that all parts listed in table are included.

Setting up

PERMANENT INSTALLATION

The Pinguino accessories include two sets of flanges and stoppers, to be mounted in different locations (two different rooms). Once installed, these vents (flanges) are the only items needed for using Pinguino.

Permanent installation outlet holes must be in an exterior wall and opening diameter should not exceed 3ⁿ/₂.

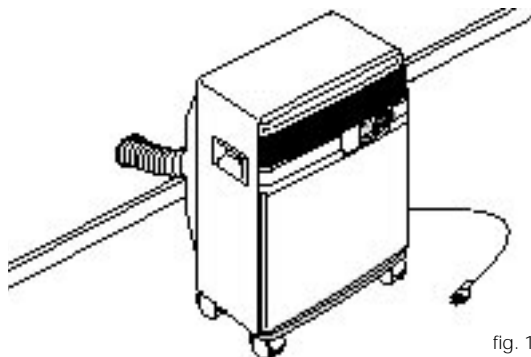

fig. 1

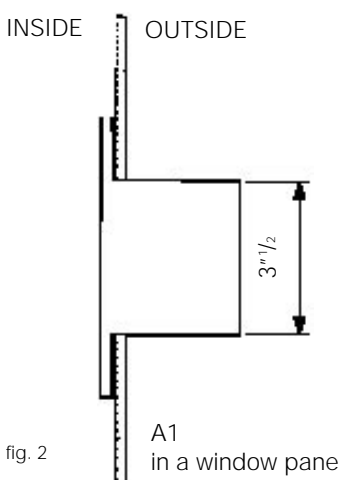

fig. 2

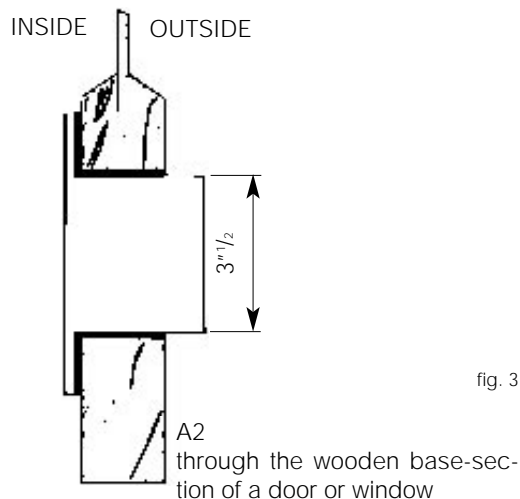

fig. 3

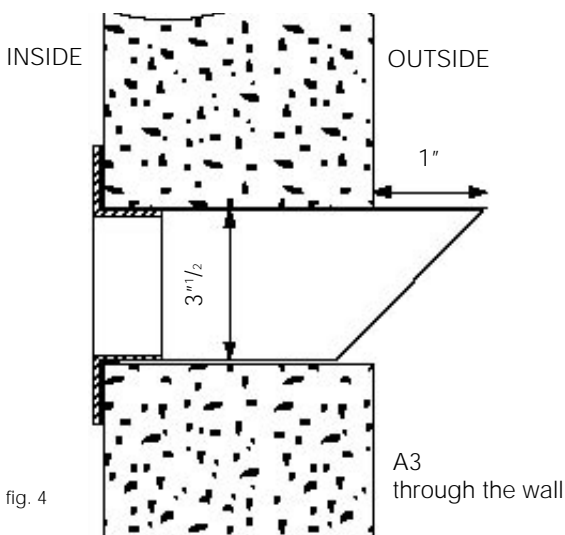

fig. 4

In case of fixed installation, air discharged from rear hose has been extracted from the room where the appliance is installed. Check that the room (especially if small) is not "air-tight"; a drop in pressure would cause irregular functioning, which could consequently activate reset switch. Air entering through door and window cracks is normally sufficient. If deemed, necessary leave a door ajar (approx. 1 cm is enough).

Setting up

TEMPORARY INSTALLATION

Note: In both cases (permanent and temporary installations) make sure that the Pinguino is positioned on level ground. If necessary use the two caster stops for the front casters

This installation makes it easy to use Pinguino in any room, provided there is a window or a door: it allows you to use the Pinguino immediately.

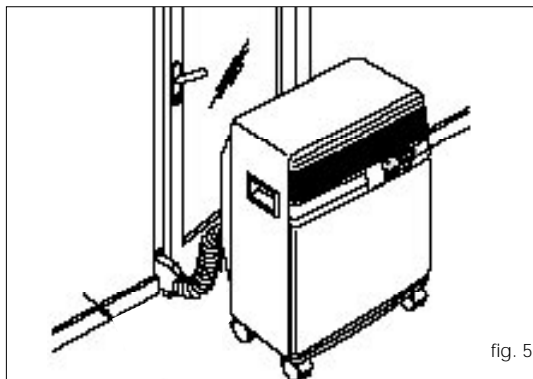

Suction discs may be used to keep window or door closed.

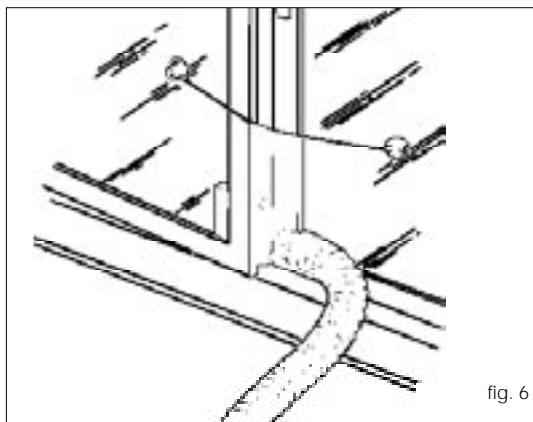

Pinguino is equipped with an adjustable window bracket. If you have a sash window, place the bracket on the window sill, extend the bracket fully within the window frame and lower the window onto the bracket. Insert the nozzle of the exhaust hose into the slot, then connect the hose to the air conditioner (fig.7). Thanks to the wing nut, it's possible to use the window bracket also for sliding windows. Position the hole of the bracket so to allow a correct installation of the exhaust hose.

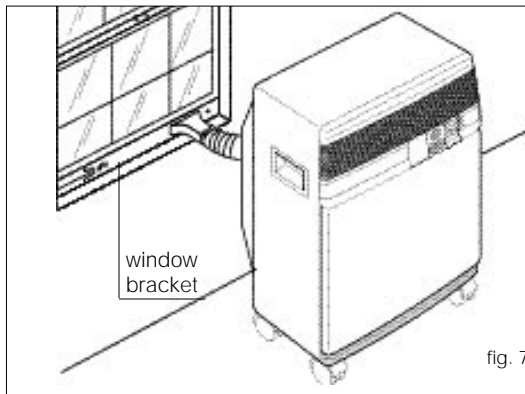

If you have a sash door, use the additional set provided in order to extend the accessory to the desired length; joining the two parts (fig. 8), adjust the total length according to your needs then, fix the bracket with the relevant nuts, close the door and connect the hose (fig. 9).

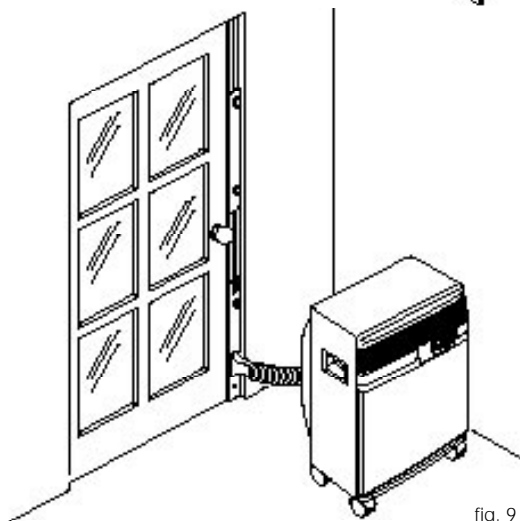
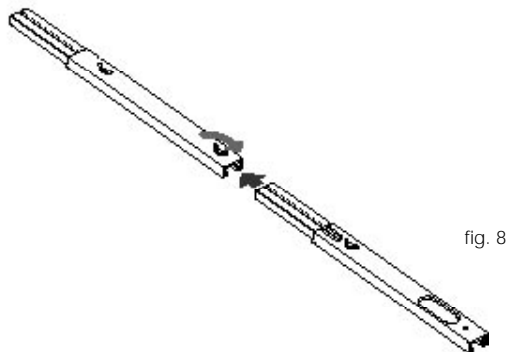

Setting up and recommendations

SET UP INSTRUCTION

For permanent installation place the Pinguino near the outlet opening in wall or window (where it is meant to be used). The diagram below shows the correct way to install the exhaust hose.

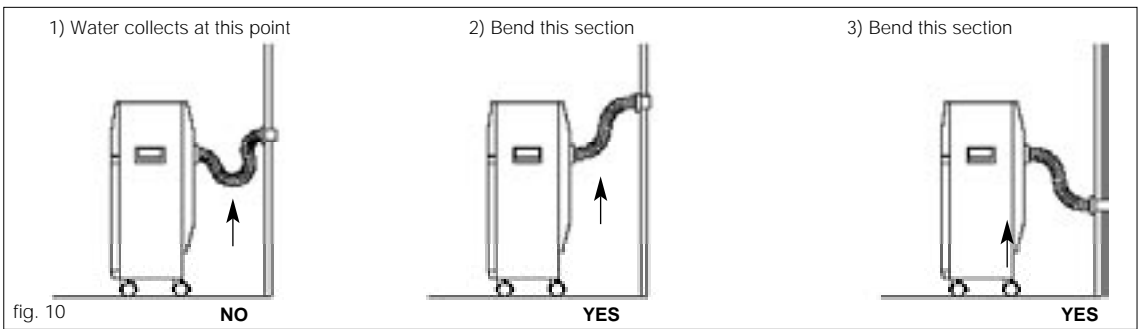

ELECTRICAL CONNECTION

Check that the power supply voltage is 115 V ~ 60 Hz.

Important: if you need to use an extension cord, please be sure to use a **heavy duty** extension cord (minimum 14 gauge).

Before connecting the Pinguino to power supply, make sure that all switches on the front control panel are in the OFF position.

Connect power cord found in storage compartment at rear of the Pinguino.

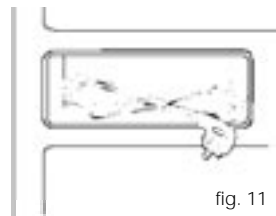

fig. 11

FINAL CHECK

In order to obtain the maximum performance from your air-conditioner make sure that:



fig. 12

- Doors and windows of room to be air-conditioned are closed (with the exception of temporary installation where a partially opened window is necessary).



fig. 13

Close the door.



fig. 14

- Shade the room as far as possible from direct sunlight by drawing curtains and/or lowering blinds or shutters, for economical and efficient air-cooling.

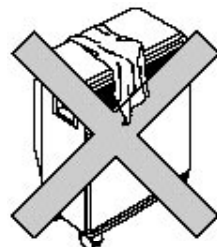
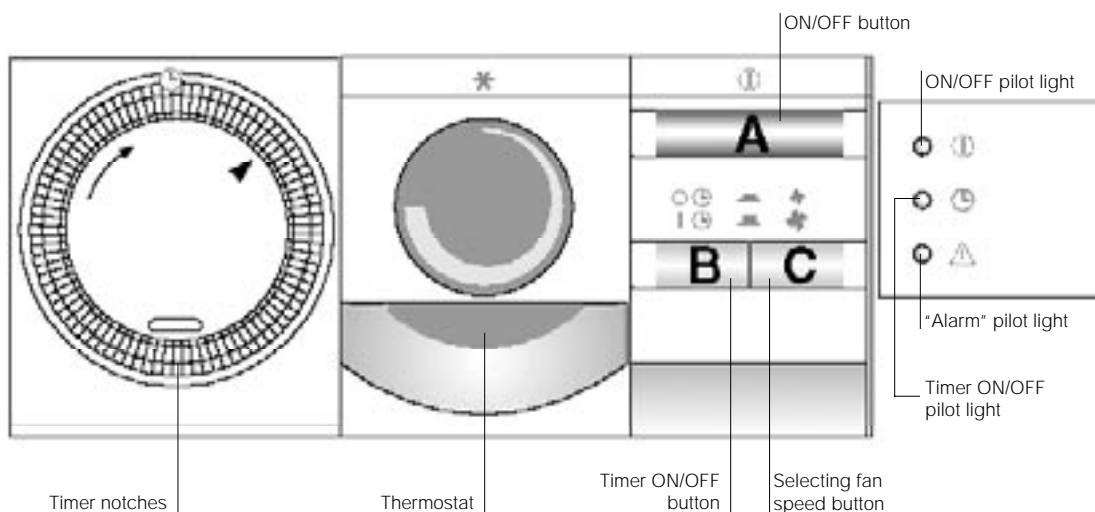

fig. 15

- Ensure that intake and outlet vents (fig. 2 and 3) are not blocked.
- Make sure there are no sources of heat in the room.

Control panel



SETTING THE TIMER

The programmer/timer, like all clocks, must be set to the exact time. If for example it is 4.00 p.m., turn the dial in a clockwise direction (following the direction of the arrow) until the number 4 is lined up with the arrow pointer (the arrows indicates 4:00 p.m. approximately).

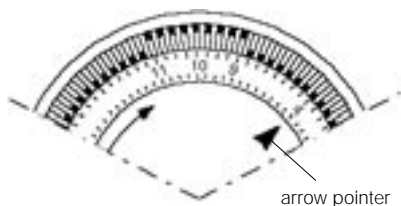

- 1) Release B timer button
- 2) Set the operating times by pushing out the notches on the dial corresponding to the period required (each notch represents 15 mins.).
- 3) Check that the timer indicates the correct time (see instructions on setting).

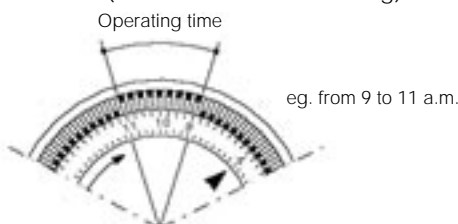

Note: Never turn the dial in an anti-clockwise direction!

The timer is in effect, an electric clock and works only if the plug is connected to the power supply. Whenever the plug is disconnected or there is a power failure, the programmer stops (the clock is then "slow") and must be re-set.

The unit can be used in either **programmed** or **non-programmed** mode.

PROGRAMMED MODE

Note: For technical reasons, the temperature is not expressed in degrees but by a line increasing in thickness. We therefore recommend that when starting up the appliance, the thermostat be turned to maximum (thick green line = maximum cold). When the desired temperature has been reached, turn the thermostat slowly away from the maximum cooling position until the appliance switches off. Leave the thermostat in this position. The air-conditioner is now programmed to maintain the exact temperature at all times.

- 4) Select the desired function as shown in the chart overleaf.
The unit will now switch on and off each day at the selected times.

Note: To override the programmed operating times, simply press the ON/OFF key.

NON-PROGRAMMED MODE

- 1) B TIMER button must be pressed
- 2) Select the desired function as shown in the chart on the following page.

After switching the appliance off, wait at least 3 min. before switching on again.

How to start up the conditioner

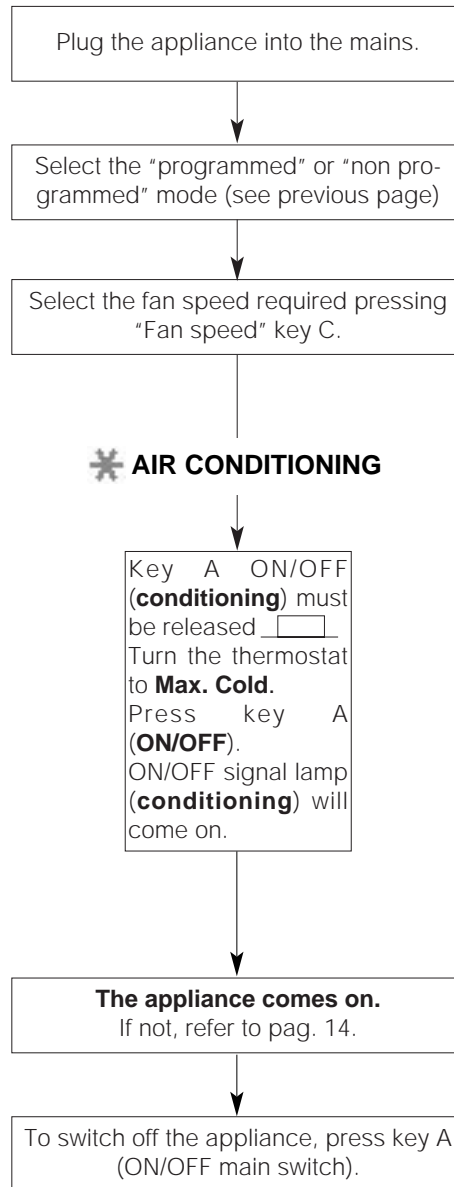

Cleaning and maintenance

PRECAUTIONS

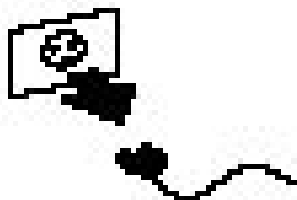

fig. 14

During cleaning and normal maintenance operations remember to disconnect plug.

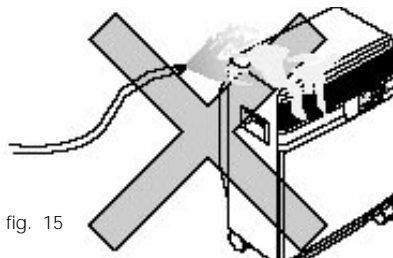

fig. 15

Under no circumstances should appliance be washed with running water. Damage could be caused to the electrical circuit.

CLEANING OF EXTERNAL HOUSING

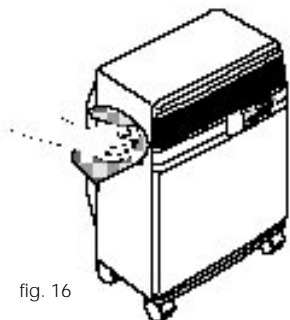

fig. 16

Clean with a damp cloth and dry thoroughly with a clean dry cloth.

Use only mild soap and water.
Do not use chemical cleaners.

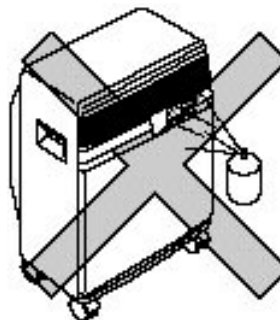
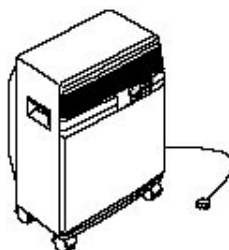

fig. 17

CONTROLS AT THE BEGINNING OF THE SEASON



Carefully follow installation procedure.



Check for any defects in power cord and plug.

fig. 18

Cleaning and maintenance

AIR FILTER CLEANING

Maintenance of air filter

A clogged air filter reduces the quantity of circulating air and the efficiency of the appliance. Clean filter every week using a vacuum cleaner.

Removal and replacement of air filter

Gently pull filter upwards.
Push down to replace.

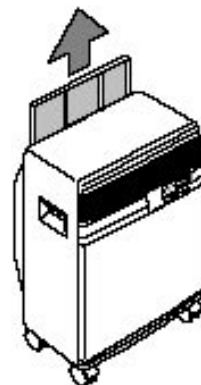
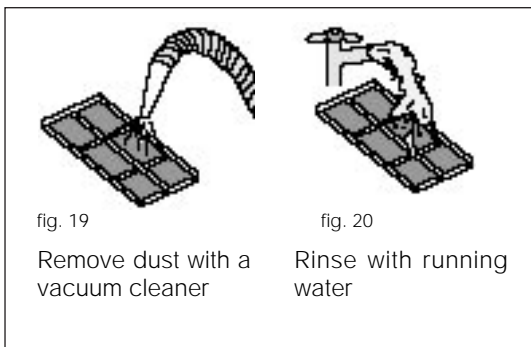

fig. 21

Cleaning procedure

To remove dust deposited on filter, use a vacuum cleaner. If it is very dirty, soak in lukewarm water and rinse thoroughly. The temperature of the water must be kept below 104°F. After washing, leave filter to dry before replacing.

END OF SEASON OPERATIONS

- 5) Cover appliance with a polyethylene bag to prevent dust from entering.



fig. 22

- 1) Disconnect plug.
- 2) Remove plug from drainage tube to empty water collecting tray.
- 3) Remove exhaust hose.
- 4) Clean filter and dry well before replacing.

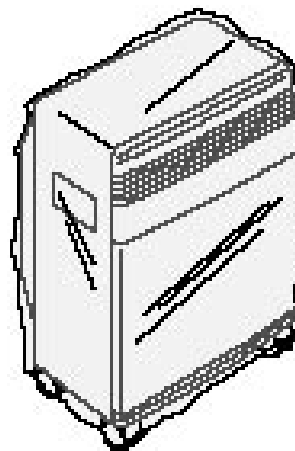
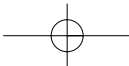

fig. 23



Troubleshooting

SYMPTOMS	CAUSE	SOLUTION
<p>The Pinguino does not function:</p>	<ul style="list-style-type: none"> - power failure - plug is disconnected - ON/OFF switch is off - Timer key is in STOP position 	<ul style="list-style-type: none"> - insert plug - switch on - release the TIMER key
<p>The Pinguino does not function</p> <ul style="list-style-type: none"> - function fault warning light is on (pag. 10 - "Alarm" light) <p>After correcting problem, press reset button (see pag. 5)</p>	<ul style="list-style-type: none"> - exhaust hose blocked - exhaust hose twisted or bent - ventilation holes on the rear of the machine or front louvers blocked 	<ul style="list-style-type: none"> - Check for obstruction of air outlet vent - eliminate irregularities - remove obstacles to allow proper airflow
<p>The Pinguino produces cold air but room does not maintain comfortable temperature:</p>	<ul style="list-style-type: none"> - window open - air exhaust hose has become disconnected - thermostat set too low - air filter blocked 	<ul style="list-style-type: none"> - close window - re-insert exhaust hose - set thermostat to higher number - clean filter

SERVICING

In case of malfunction turn off and disconnect the Pinguino from power outlet and contact our Service Centre for qualified assistance, toll-free number 1-800-322-3848.

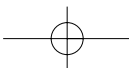
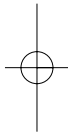
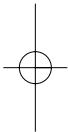

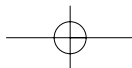



LIMITED WARRANTY

We warrant each DE'LONGHI AIR-CONDITIONER to be free from defects in material and workmanship. Our obligation under this warranty is to provide one year parts and labor free from purchase date, with an additional four (4) years on any part of the sealed system consisting of the compressor, evaporator, condenser and factory connected refrigerant tubing. This warranty shall apply only if the AIR-CONDITIONER is used in accordance with the factory directions which accompany it, and on Alternatign Current (AC) circuit. This warranty is in lieu of all other warranties and representations, expressed or implied, and all other obligations or liabilities on our part. We do not authorize any other person or company to assume for us any liability in connection with the sale or use of our AIR-CONDITIONER. This warranty shall not apply to assume for us any liability in connection with the sale or use of our AIR-CONDITIONER. This warranty shall not apply to any AIR-CONDITIONER which shall have been repaired or altered outside our factory nor shall it apply to any AIR-CONDITIONER which has been subjected to misuse, negligence or accidents.

If repairs become necessary or spare parts are needed, please write to:

<p>De'Longhi America Inc. Park 80 West Plaza One 4th floor Saddle Brook, NJ 07663 or call Service Tel. No. 1-800-322-3848</p>	<p>De' Longhi CANADA 1040 Ronsa Court MISSISSAUGA, ONTARIO L4W 3Y4 CANADA or call Service Tel. No. 1-888-335-6644</p>
--	--

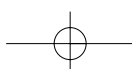
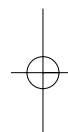
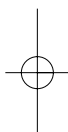

Free Manuals Download Website

<http://myh66.com>

<http://usermanuals.us>

<http://www.somanuals.com>

<http://www.4manuals.cc>

<http://www.manual-lib.com>

<http://www.404manual.com>

<http://www.luxmanual.com>

<http://aubethermostatmanual.com>

Golf course search by state

<http://golfingnear.com>

Email search by domain

<http://emailbydomain.com>

Auto manuals search

<http://auto.somanuals.com>

TV manuals search

<http://tv.somanuals.com>