



De'Longhi America, Inc.
250 Pehle Avenue, Suite 405
Saddle Brook, NJ 07663
1-800-322-3848

De'Longhi Canada, Inc.
6150 McLaughlin Road
Mississauga, Ontario
L5R 4E1 Canada
1-888-335-6644

Fiducia Italiana S.A de C.V
Erasmus Castellanos Quinto
calle B manzana II #29 - Col. Educación
C.P. 04400
Deleg. Coyoacán – MEXICO D.F.
Lada sin costo: 1800 711 8805

www.delonghi.com



**IMPORTANT INSTRUCTIONS
SAVE THESE INSTRUCTIONS**

**MODE D'EMPLOI IMPORTANT
CONSERVEZ LES PRESENTES INSTRUCTIONS**

**INSTRUCCIONES IMPORTANTES
REPASE Y GUARDE ESTAS INSTRUCCIONES
LEA CUIDADOSAMENTE ESTE INSTRUCTIVO ANTES DE UTILIZAR EL APARATO**

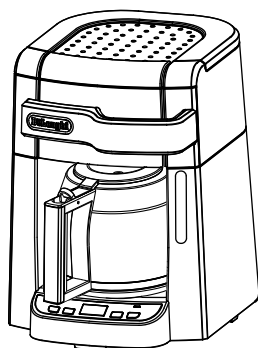

**COFFEE MAKER TYPE DCF2112T/DCF2212T/DCF2210TTC
CAFETERIE MODÈLE DCF2112T/DCF2212T/DCF2210TTC
CAFETERA ELECTRICA MODELO DCF2112T/DCF2212T/DCF2210TTC**

Register this product on-line and receive a free trial issue of Cook's Illustrated. Visit www.delonghiregistration.com.
Visit www.delonghi.com for a list of service centers near you. (U.S. and Canada only)

Enregistrez ce produit en ligne et recevez un numéro gratuit de Cook's Illustrated. Visitez www.delonghiregistration.com.
Visitez www.delonghi.com pour y voir une liste des centres de réparation proches de chez vous. (E.-U. et Canada).

Registre este producto en línea y reciba un ejemplar gratis de Cook's Illustrated. Visite www.delonghiregistration.com.
Visite www.delonghi.com para ver la lista de centros de servicios cercanos a usted. (Estados Unidos y Canada)

**ELECTRIC CHARACTERISTICS: CARACTÉRISTIQUES ÉLECTRIQUES: CARACTERISTICAS ELECTRICAS
120 V~ 60 Hz 1 000 W**

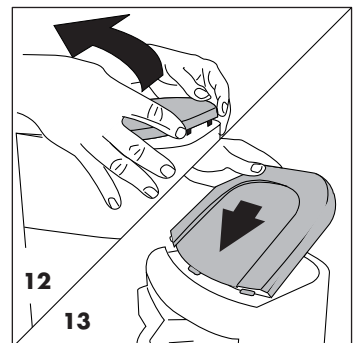
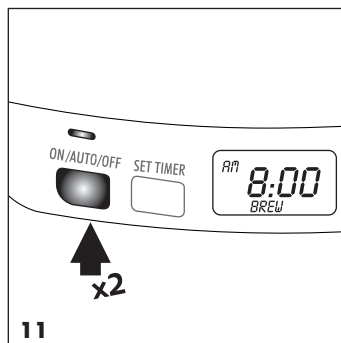
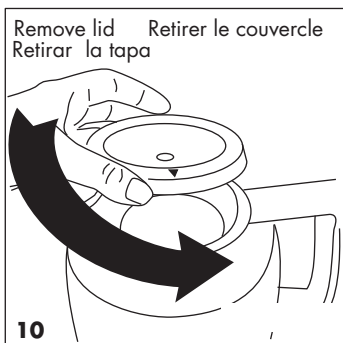
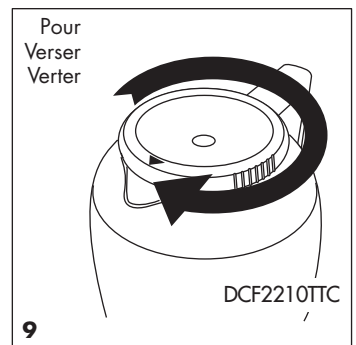
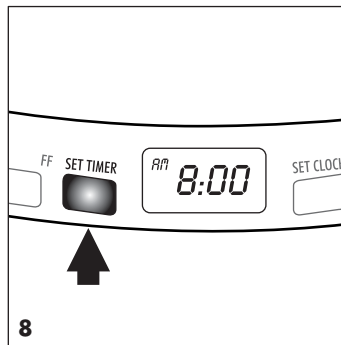
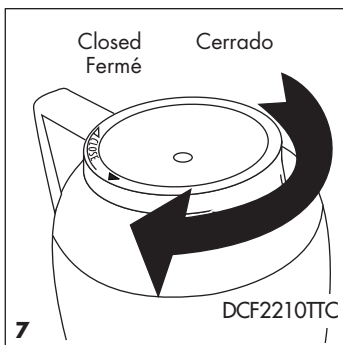
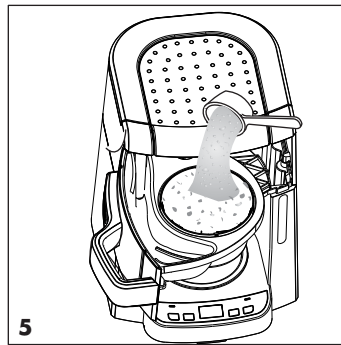
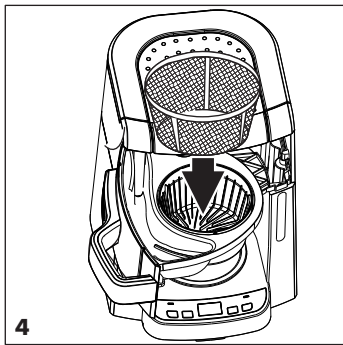
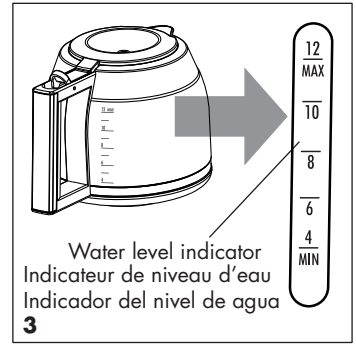
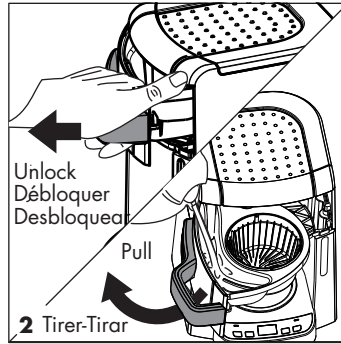
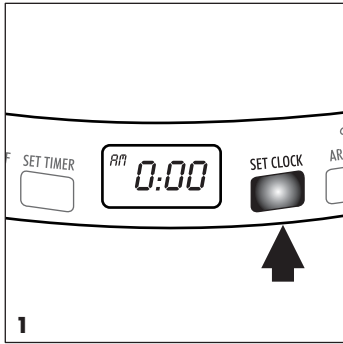

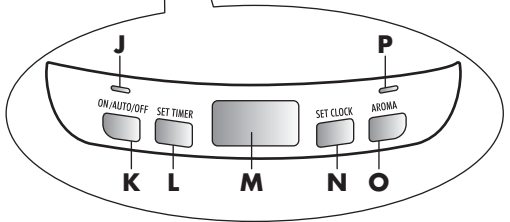
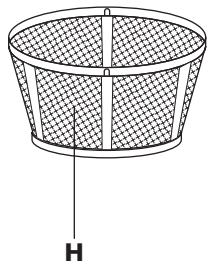
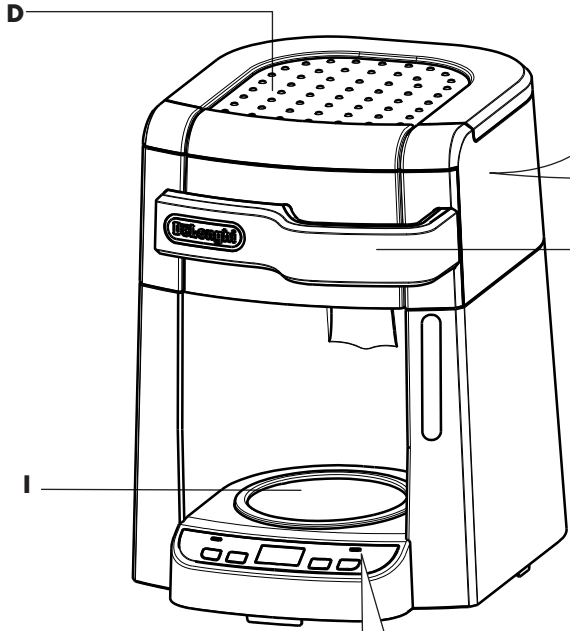
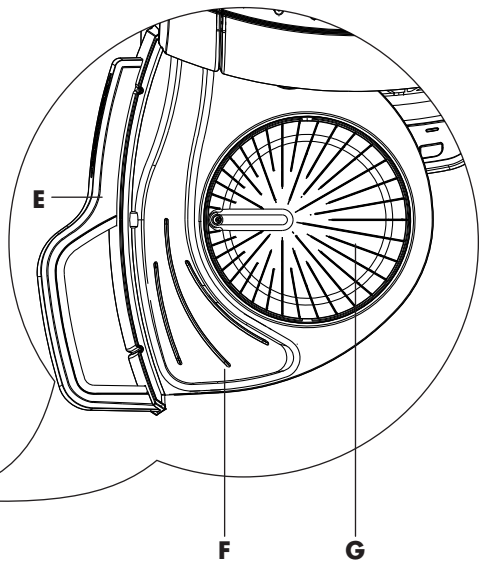
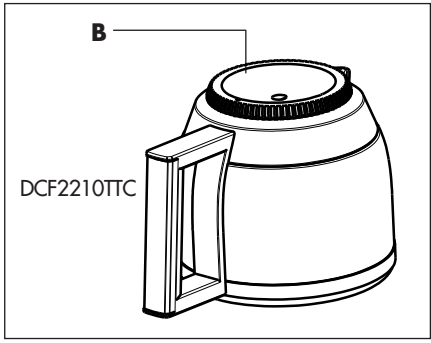
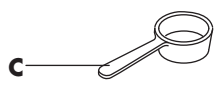
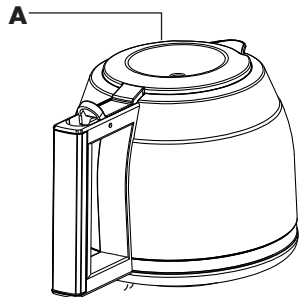

Free Manuals Download Website

<http://myh66.com>

<http://usermanuals.us>

<http://www.somanuals.com>

<http://www.4manuals.cc>

<http://www.manual-lib.com>

<http://www.404manual.com>

<http://www.luxmanual.com>

<http://aubethermostatmanual.com>

Golf course search by state

<http://golfingnear.com>

Email search by domain

<http://emailbydomain.com>

Auto manuals search

<http://auto.somanuals.com>

TV manuals search

<http://tv.somanuals.com>