



www.delonghi.com

Instructions for use. Keep these instructions.

Mode d'emploi. Conservez cette notice.

Instrucciones para el uso. Repase y guarde estas instrucciones. Lea cuidadosamente este instructivo antes de usar su aparato.

COFFEE MAKER MACHINE À CAFÉ CAFETERA

DCF6212TTC/DCF6214T/DCF6114T



Register this product on-line and receive a free trial issue of Cook's Illustrated. Visit www.delonghiregistration.com. Visit www.delonghi.com for a list of service centers near you.

Enregistrez ce produit en ligne et recevez un numéro gratuit de Cook's Illustrated. Visitez www.delonghiregistration.com. Visitez www.delonghi.com pour voir une liste des centres de réparation proches de chez vous.

Registre este producto en línea y reciba un ejemplar gratis de Cook's Illustrated. Visite www.delonghiregistration.com. Visite www.delonghi.com para ver la lista de centros de servicios cercanos a usted.

ELECTRONIC CHARACTERISTICS: CARACTÉRISTIQUES ÉLECTRIQUES: CARACTERISTICAS ELECTRICAS:
120 V- 60 Hz 1 000 W

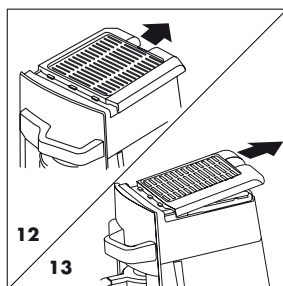
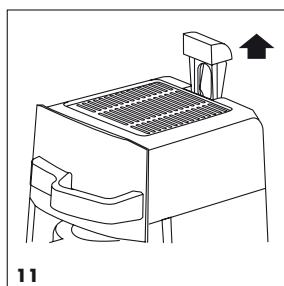
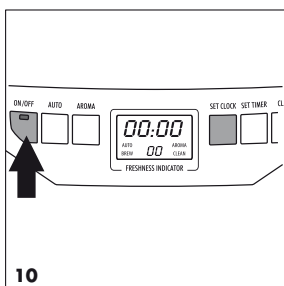
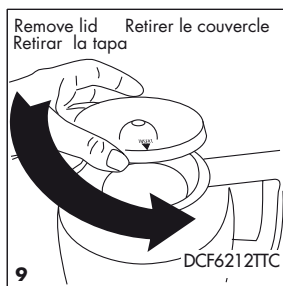
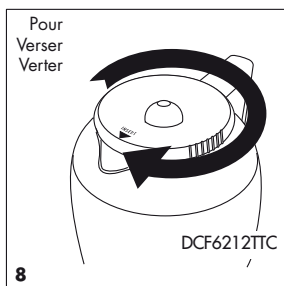
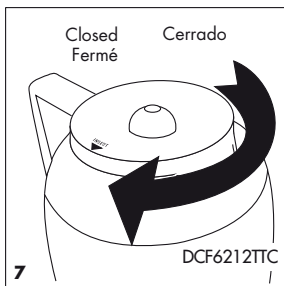
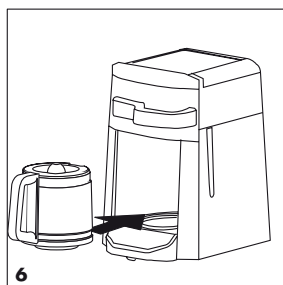
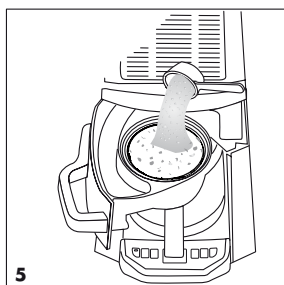
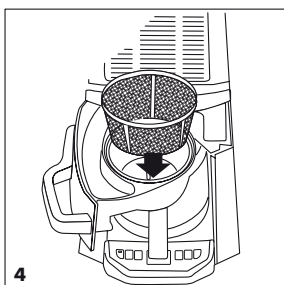
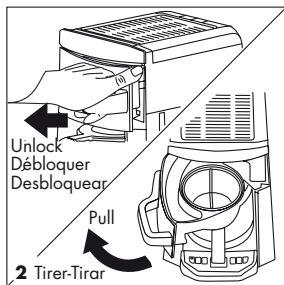
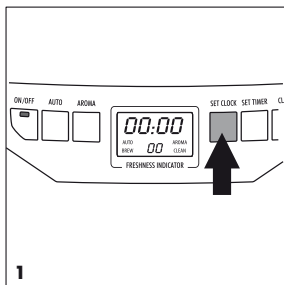

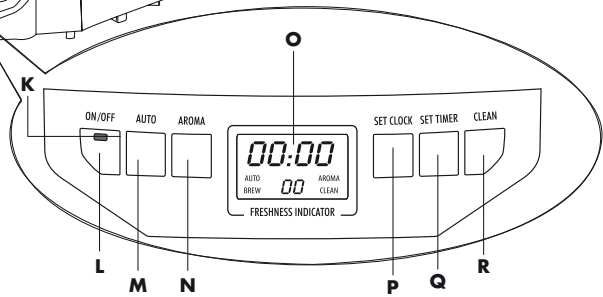
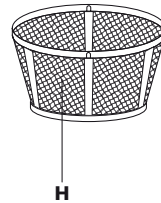
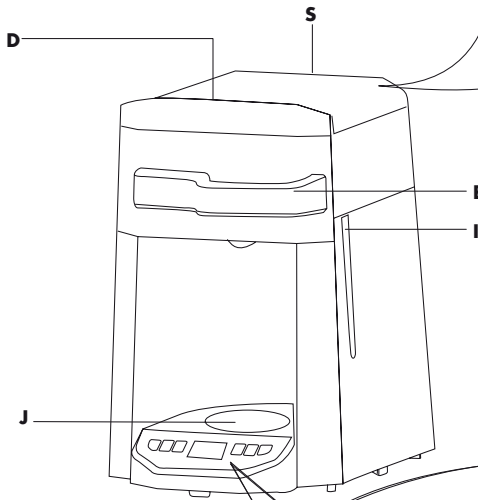
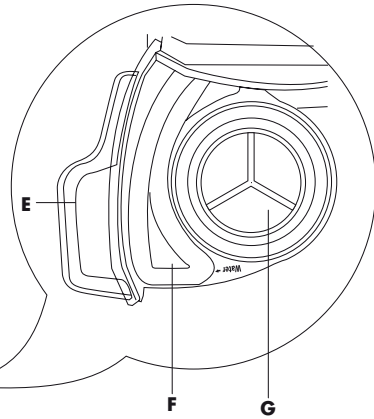
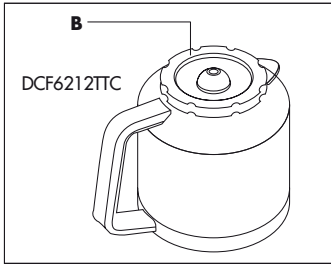
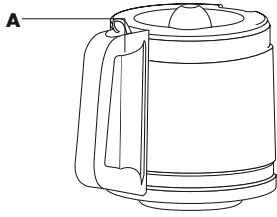

Free Manuals Download Website

<http://myh66.com>

<http://usermanuals.us>

<http://www.somanuals.com>

<http://www.4manuals.cc>

<http://www.manual-lib.com>

<http://www.404manual.com>

<http://www.luxmanual.com>

<http://aubethermostatmanual.com>

Golf course search by state

<http://golfingnear.com>

Email search by domain

<http://emailbydomain.com>

Auto manuals search

<http://auto.somanuals.com>

TV manuals search

<http://tv.somanuals.com>