



www.delonghi.com

Instructions for use. Keep these instructions
Mode d'emploi. Conservez cette notice
Instrucciones para el uso . Repase y guarde estas
instrucciones. Lea cuidadosamente este instructivo antes
de usar su aparato

**COFFEE MAKER
MACHINE À CAFÉ
CAFETERA**

EC5/6



Register this product on-line and receive a free trial issue of
Cook's Illustrated. Visit www.delonghiregistration.com.
Visit www.delonghi.com for a list of service centers near you.

Enregistrez ce produit en ligne et recevez un numéro gratuit de
Cook's Illustrated. Visitez www.delonghiregistration.com.
Visitez www.delonghi.com pour y voir une liste des centres de
réparation proches de chez vous.

Registre este producto en línea y reciba un ejemplar gratis de
Cook's Illustrated. Visite www.delonghiregistration.com.
Visite www.delonghi.com para ver la lista de centros de
servicios cercanos a usted.

**ELECTRONIC CHARACTERISTICS: CARACTÉRISTIQUES ÉLECTRIQUES: CARACTERISTICAS ELECTRICAS:
120V 60Hz - 800 W**



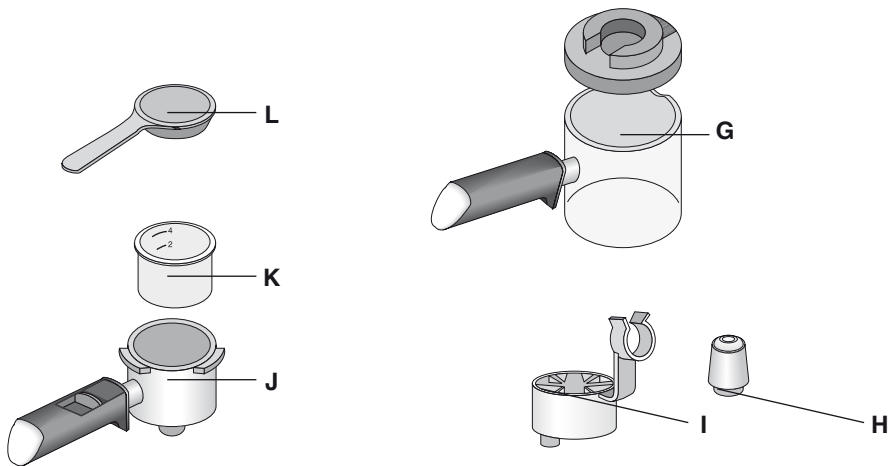
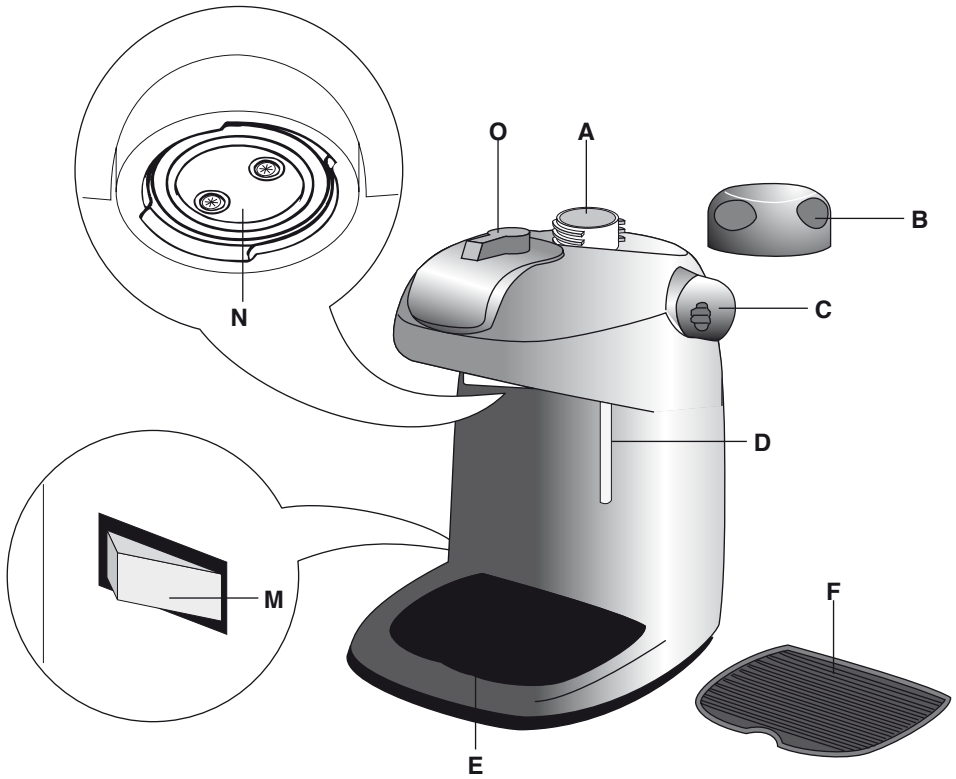

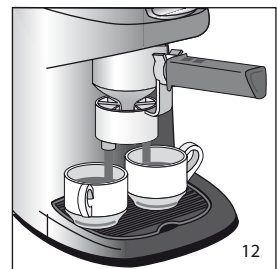
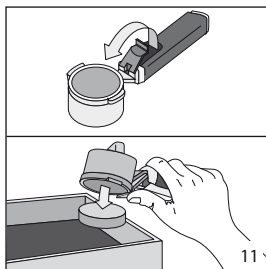
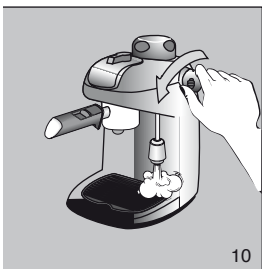
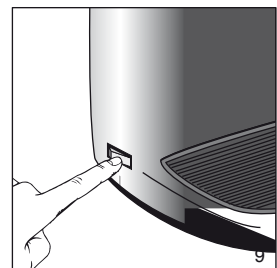
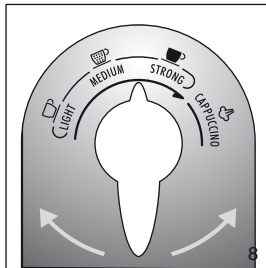
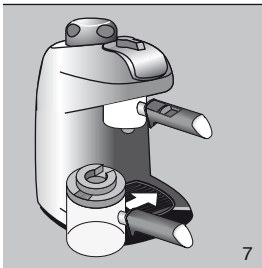
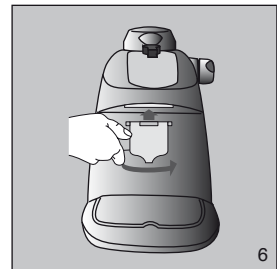
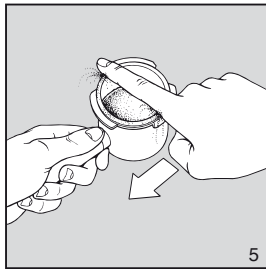
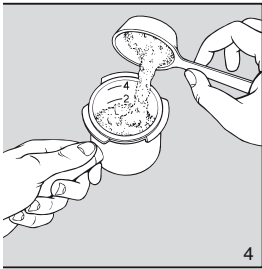
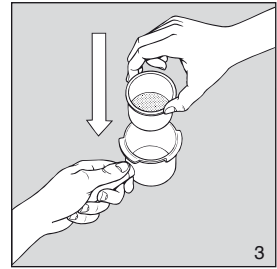
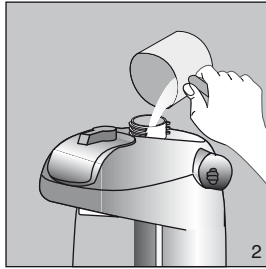
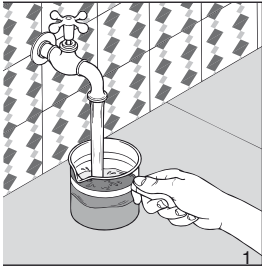

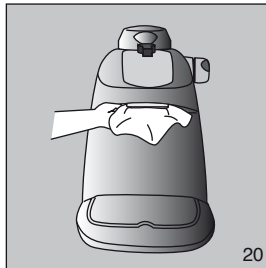
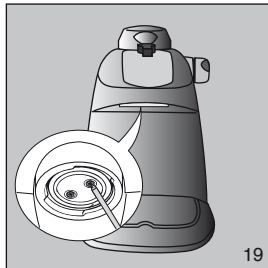
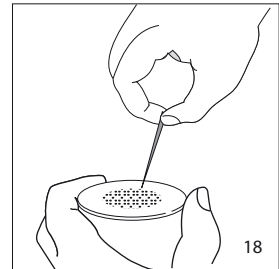
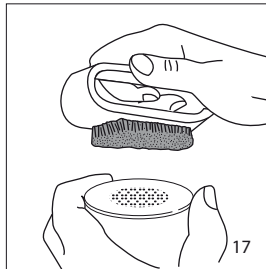
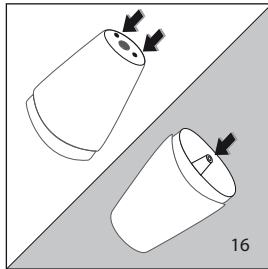
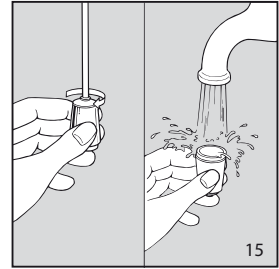
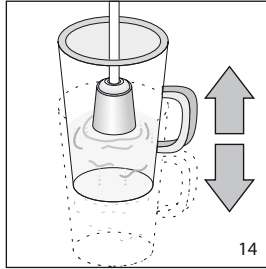
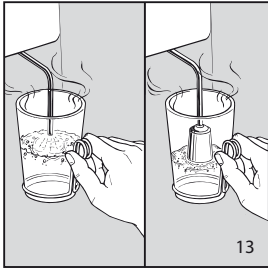

Free Manuals Download Website

<http://myh66.com>

<http://usermanuals.us>

<http://www.somanuals.com>

<http://www.4manuals.cc>

<http://www.manual-lib.com>

<http://www.404manual.com>

<http://www.luxmanual.com>

<http://aubethermostatmanual.com>

Golf course search by state

<http://golfingnear.com>

Email search by domain

<http://emailbydomain.com>

Auto manuals search

<http://auto.somanuals.com>

TV manuals search

<http://tv.somanuals.com>