

Instructions for use. Keep these instructions
Mode d'emploi. Conservez cette notice
Instrucciones para el uso. Repase y guarde
estas instrucciones. Lea cuidadosamente este
instructivo antes de usar su aparato

**FULLY AUTOMATIC COFFEE CENTER
MACHINE À CAFÈ AUTOMATIQUE
CAFETERA SUPERAUTOMATICA
ECAM23210B/SB**



Register this product on-line and receive a free trial
issue of Cook's Illustrated.
Visit www.delonghiregistration.com.
Visit www.delonghiusa.com for a list of service centers
near you. (U.S. and Canada Only)

Registre este producto en línea y reciba un ejemplar
gratis de Cook's Illustrated. Visite www.delonghiregistration.com. Visite www.delonghiusa.com para ver la
lista de centros de servicios cercanos a usted. (Solamente
en los Estados Unidos y Canada)

Enregistrez ce produit en ligne et recevez un
numéro gratuit de Cook's Illustrated. Visitez www.delonghiregistration.com. Visitez www.delonghiusa.com
pour y voir une liste des centres de réparation proches de
chez vous. (É.-U. et Canada uniquement)

Electronic Characteristics: Caractéristiques électriques: Características electricas: Caratteristiche elettriche:
120 V ~60Hz 1 350W

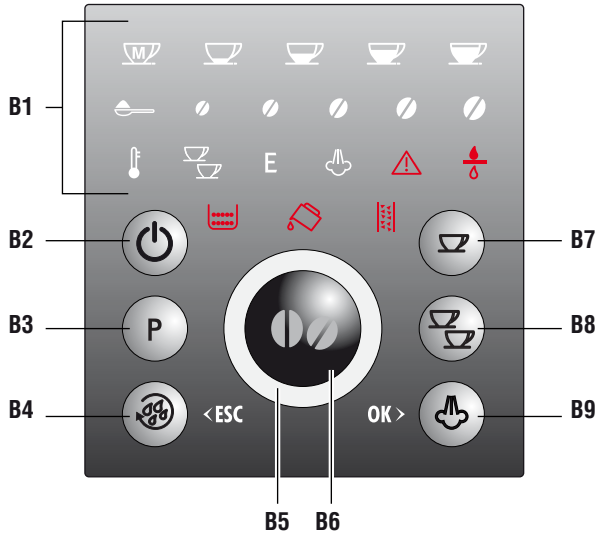
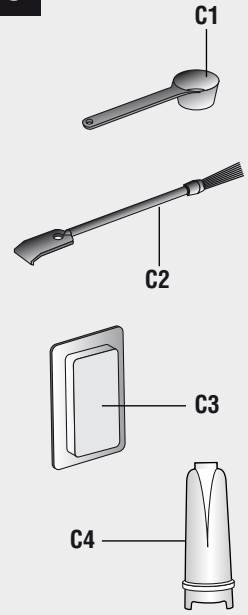
B**C**

A

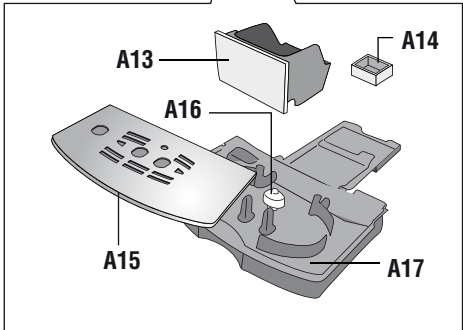
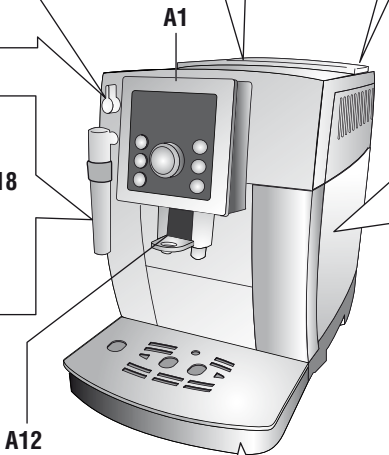
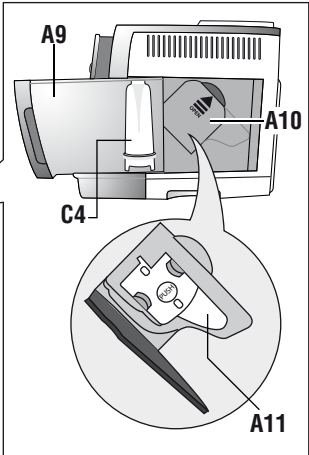
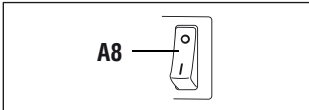
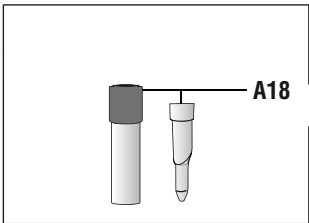
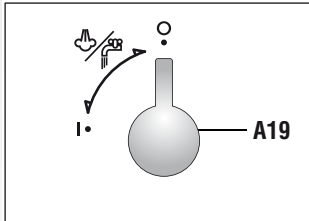
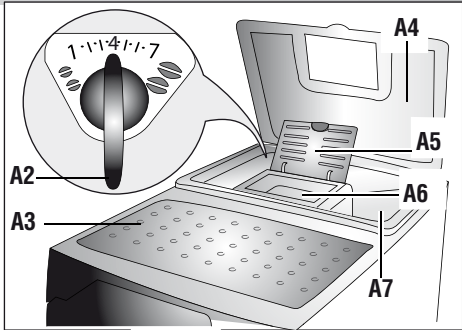

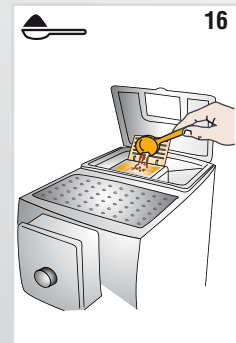
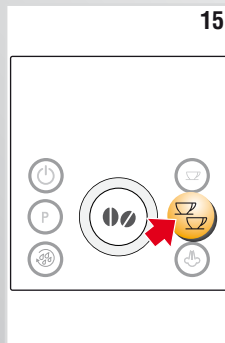
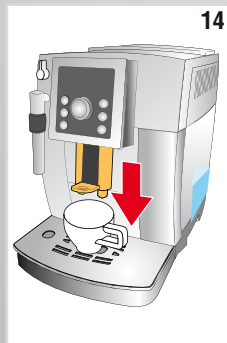
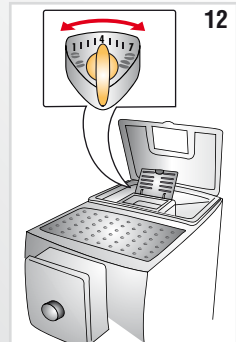
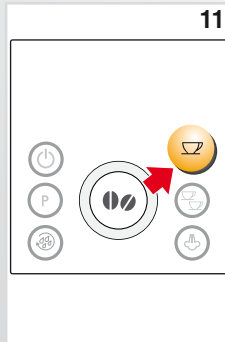
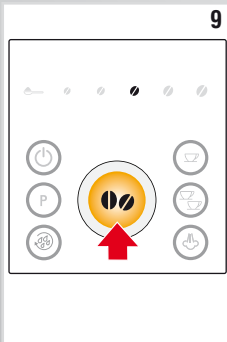
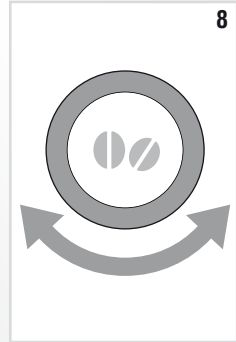
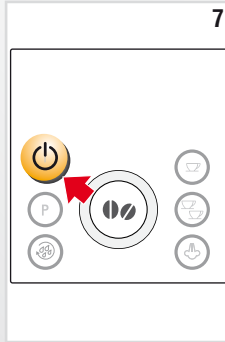
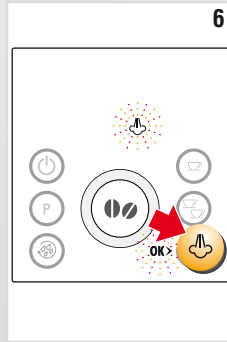
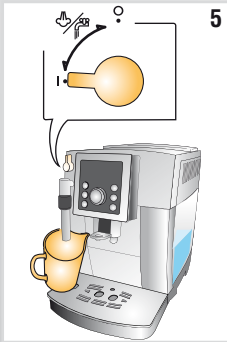
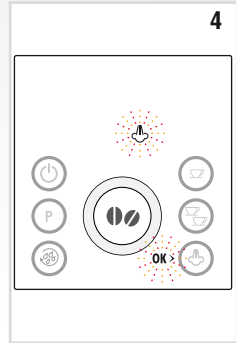
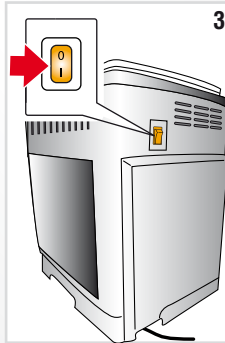
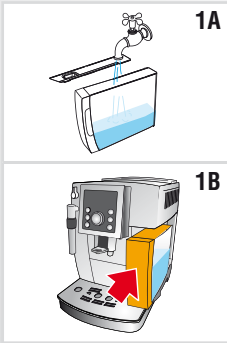

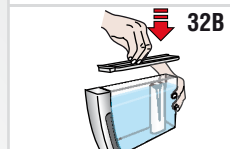
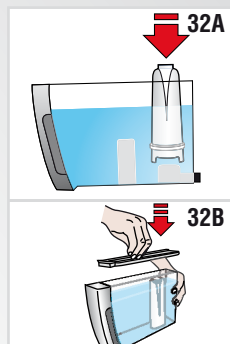
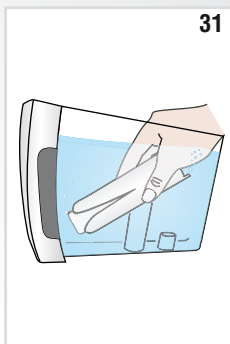
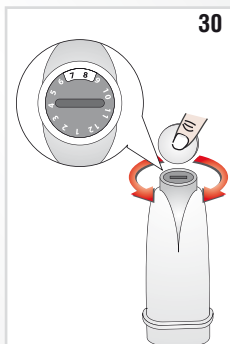
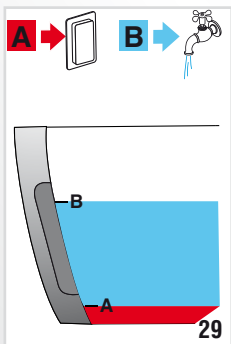
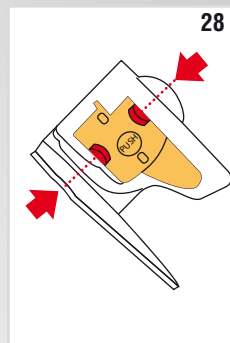
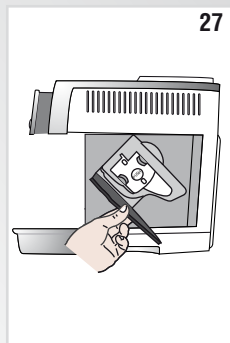
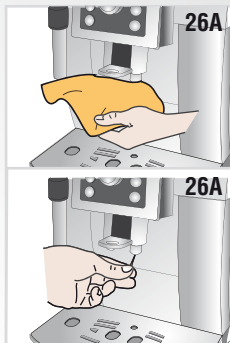
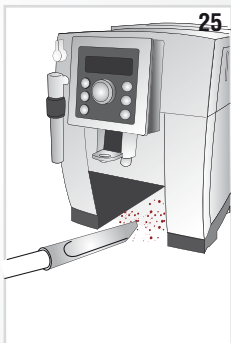
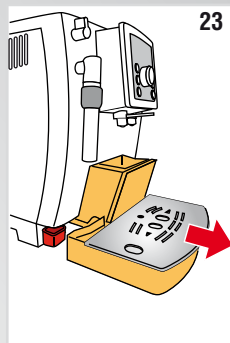
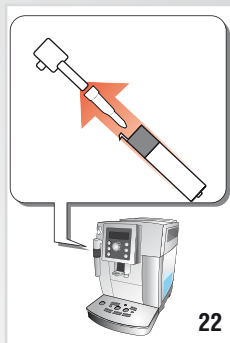
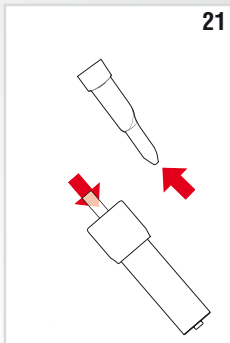
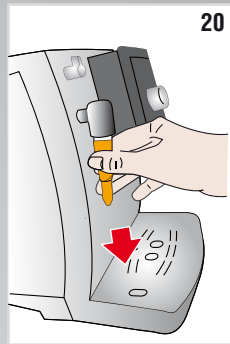
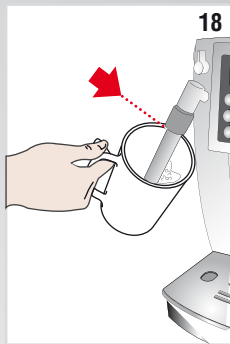
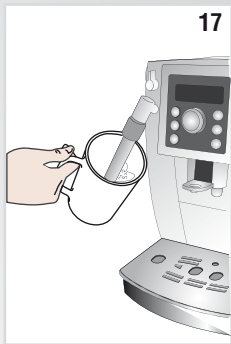

CONTENTS	
IMPORTANT SAFEGUARDS	7
SAVE THESE INSTRUCTIONS	7
SHORT CORD INSTRUCTIONS	7
INTRODUCTION	8
Letters in brackets	8
Troubleshooting and repairs	8
Description of the appliance	8
Description of the control panel	8
Description of the accessories	9
Description of lights	9
PRELIMINARY CHECKS	9
Checking the appliance	9
Connecting the appliance	9
Using the appliance for the first time	9
TURNING THE APPLIANCE ON	10
TURNING THE APPLIANCE OFF	10
MENU SETTINGS	10
Descalc	10
Auto-off	11
Setting the temperature	11
Energy Saving	11
Setting water hardness	11
Install filter	11
Replacing the filter	11
Default values (reset)	11
Statistics function	11
MAKING COFFEE	12
Selecting the coffee taste	12
Selecting the quantity of coffee in the cup	12
Customizing the "my coffee" quantity	12
Adjusting the coffee mill	12
Tips for a hotter coffee	13
Making coffee using coffee beans	13
Making coffee using pre-ground coffee	13
MAKING CAPUCCINO	13
Cleaning the cappuccino maker after use.	14
HEATING WATER	14
CLEANING	14
Cleaning the coffee maker	14
Cleaning the coffee grounds container	15
Cleaning the drip tray and condensate tray	15
Cleaning the inside of the coffee maker	15
Cleaning the water tank	15
Cleaning the coffee spouts	15
Cleaning the pre-ground coffee funnel	15
Cleaning the infuser	15
DESCALE	16
SETTING WATER HARDNESS	17
Measuring water hardness	17
Set water hardness	17
WATER SOFTENER FILTER	17
Installing the filter	17
Replacing the filter	18
Removing the filter	18
TECHNICAL SPECIFICATION	18
EXPLANATION OF LIGHTS	19
TROUBLESHOOTING	21
LIMITED WARRANTY	22

IMPORTANT SAFEGUARDS

When using electrical appliances, basic safety precautions should always be followed, including the following.

- Read all instructions carefully.
- Make sure the voltage of your electrical system corresponds to the voltage shown on the bottom of the machine.
- Do not touch hot surfaces. Use handles or knobs.
- To protect against fire, electrical shock and personal injury, do not immerse cord, plug or appliance in water or other liquid.
- Keep the appliance out of the reach of children and do not leave appliance unattended while in operation.
- Unplug from the outlet when not in use and before cleaning.
- Do not operate with a damaged cord or plug, or after the appliance malfunctions, or has been damaged in any manner. Return the appliance to the nearest authorized service facility for examination, repair or adjustment.
- The use of accessory attachments not recommended by the manufacturer may result in fire, electrical shock, or personal injury.
- Do not use outdoors.
- Make sure the power cord does not hang over the edge of the table or counter-top to avoid getting accidentally caught or entangled.
- Do not place the appliance or its electrical parts on or near electric stoves, cooking surfaces, or gas burners.
- Plug cord into the wall outlet. To disconnect, first turn machine "off", then remove plug from wall outlet.
- Do not use the appliance for other than the intended use. This appliance is to be utilized for domestic use only. The manufacturer declines all responsibility for any damage caused by improper, incorrect, or irresponsible use.

WARNING: To reduce the risk of fire or electric shock, do not remove the cover or the exterior of the unit. Don't attempt to repair or modify the machine, doing so will void the warranty. Repair should be done by authorized service personnel only!

SAVE THESE INSTRUCTIONS

THIS APPLIANCE IS FOR HOUSEHOLD USE ONLY

SHORT CORD INSTRUCTIONS

A short power cord is provided to reduce risks resulting from becoming entangled in or tripping over a longer cord.

- Longer, detachable power supply cords or extension cords are available and may be used if care is exercised in their use.
- If an extension cord is used, the marked electrical rating should be at least as great as the electrical rating of the appliance. If the appliance is provided with 3- wire, grounding type cord, the extension should be a GROUNDING TYPE 3 - WIRE CORD. The longer cord should be arranged so that it will not drape over the counter-top or table top where it can be pulled on by children or tripped over.
- Your product is equipped with a polarized alternating current line plug (a plug having one blade wider than the other). This plug will fit into the power outlet only one way. This is a safety feature. If you are unable to insert the plug fully into the outlet, try reversing the plug. If the plug should still fail to fit, contact your electrician to replace your obsolete outlet. Do not defeat the safety purpose of the polarized plug.

INTRODUCTION

Thank you for choosing the ECAM 23.210 automatic coffee and cappuccino maker.

We hope you enjoy using your new appliance.

Take a few minutes to read these instructions.

This will avoid all risks and damage to the machine.

Symbols used in these instructions

Important warnings are identified by these symbols. These warnings must absolutely be respected.



Danger!

Failure to observe the warning could result in possibly life threatening injury from electric shock.



Important!

Failure to observe the warning could result in injury or damage to the appliance.



Danger of burns!

Failure to observe the warning could result in scalds or burns.



Please note:

This symbol identifies important advice or information for the user.

Letters in brackets

The letters in brackets refer to the legend in the Description of the Appliance on page 3.

Troubleshooting and repairs

In the event of problems, first try and resolve them following the information given in the section "Explanation of lights" on page 19 and "Troubleshooting" on page 21.

If this does not resolve the problem or you require further information, you should consult Customer Services by calling the number given on the annexed "Customer Service" sheet.

If your country is not among those listed on the sheet, call the number given in the guarantee.

If repairs are required, contact De'Longhi Customer Services only.

The addresses are given in the guarantee certificate provided with the appliance.

DESCRIPTION

Description of the appliance

(page 3 - **A**)

- A1. Control panel
- A2. Grinding adjustment knob
- A3. Cup shelf
- A4. Beans container lid
- A5. Pre-ground coffee funnel lid
- A6. Pre-ground coffee funnel
- A7. Beans container
- A8. Main switch
- A9. Water tank
- A10. Infuser door
- A11. Infuser
- A12. Coffee spout (adjustable height)
- A13. Coffee grounds container
- A14. Condensate tray
- A15. Cup tray
- A16. Drip tray water level indicator
- A17. Drip tray
- A18. Cappuccino maker
- A19. Steam/hot water knob

Description of the control panel

(page 2 - **B**)

A number of buttons on the panel have a double function. This is indicated in brackets in the description.









- B1. Lights
- B2. button: turns the appliance on and off.
- B3. **P** button to access the menu
- B4. button: to perform a rinse cycle.
(When in the settings MENU, it acts as the "ESC" button to exit from the selected function and go back to the main menu).
- B5. Selection knob: turn to select the required quantity of coffee. (When in the settings MENU, turn to select the required function).
- B6. coffee strength button: to select the coffee taste
- B7. button: to make 1 cup of coffee with the settings displayed
- B8. button: to make 2 cups of coffee with the settings displayed
- B9. button: to deliver steam to make hot drinks with milk.
(When you access the MENU: Press "OK" button to confirm the selection made)

Description of the accessories

(page 2 - )

- C1. Measure
- C2. Cleaning brush
- C3. Descaler bottle
- C4. Water softener filter (certain models only)

Description of lights

-  Light flashing: the machine is heating up or a rinse cycle is underway.
-  The appliance is delivering two cups of coffee.
- E** “Energy Saving” mode is active.
-  Light on steadily: the “steam” function has been selected;
Light flashing: you must turn the steam knob.
-  An alarm is displayed on the control panel (see the section: “Explanation of lights”).
-  Light flashing: the water softener filter must be replaced.
-  Light on steadily: the grounds container is missing and must be inserted in the appliance;
Light flashing: the grounds container is full and must be emptied.
-  Light on steadily: the water tank is missing;
Light flashing: there is not enough water in the tank.
-  Light flashing: the appliance must be descaled (see the section “Descaling”).
- <ESC** Indicates the button to press to exit the programming menu or selected function.
- OK >** Indicates the button to press to confirm the function selected in the programming menu.

PRELIMINARY CHECKS

Checking the appliance

After removing the packaging, make sure the product is complete and undamaged and that all accessories are present.

Do not use the appliance if it is visibly damaged. Contact De’Longhi Customer Services.

Installing the appliance

 *Important!*

When installing the appliance, respect the following safety warnings:

- The appliance gives off heat.
After positioning the appliance on the worktop, leave a space of at least 1,18 in/ 3 cm between the surfaces of the appliance and the side and rear walls and at least 5,9 in/ 15 cm above the coffee maker.
- Water penetrating the coffee maker could cause damage.
Do not place the appliance near taps or sinks.
- The appliance could be damaged if the water it contains freezes.
Do not install the appliance in a room where the temperature could drop below freezing point.
- Arrange the power cable in such a way that it cannot be damaged by sharp edges or contact with hot surfaces (e.g. electric hot plates).

Connecting the appliance

 *Important!*

Check that the mains power supply voltage corresponds to the value indicated on the rating plate on the bottom of the appliance.

If the power socket does not match the plug on the appliance, have the socket replaced with a suitable type by a qualified professional.



Using the appliance for the first time

 *Please note!*

- Coffee has been used to factory test the appliance and it is therefore completely normal for there to be traces of coffee in the mill.
The machine is, however, guaranteed to be new.

- You should customize water hardness as soon as possible following the instructions in the section “Setting water hardness” on page 17.

Follow the instructions:

- Remove the water tank, fill to the MAX line with fresh water (fig. 1A) then put back in the appliance (fig. 1B).
- Place a container with a minimum capacity of 3.4oz (100ml) under the cappuccino maker (fig. 2).
- Plug the appliance into the mains socket and place the main switch on the back of the appliance in the I position (fig. 3).
- The  light flashes on the control panel (fig. 4).
- Turn the steam knob to the “I” position (fig. 5) and press the  button to confirm (fig. 6). The appliance delivers water from the cappuccino maker then goes off.
- Turn the steam knob to the “0” position. The coffee maker is now ready for normal use.

 *Please note!*

- When using the appliance for the first time, you need to make 4-5 cups of coffee or 4-5 cappuccinos before the appliance starts to give satisfactory results.
- To enjoy your coffee even more and improve the performance of your appliance, we recommend installing a water softener filter as described in the section “WATER SOFTENER FILTER”.

If your model is not provided with a filter, you can request one from De’Longhi Customer Services.

TURNING THE APPLIANCE ON

 *Please note!*

Before turning the appliance on, make sure the main switch on the back of the appliance is in the I position (fig. 3).



Each time the appliance is turned on, it performs an automatic preheat and rinse cycle which cannot be interrupted.

The appliance is ready for use only after completion of this cycle.

 *Danger of burns!*

During rinsing, a little hot water comes out of the coffee spouts and is collected in the drip tray underneath.

Avoid contact with splashes of water.

- To turn the appliance on, press the  button (fig. 7). The  light flashes while the appliance is heating up and performing an automatic rinse cycle. By circulating hot water, the appliance heats both the boiler and the internal circuits.

The appliance is at temperature when the  light goes off and the lights corresponding to the selected coffee taste and quantity come on.

TURNING THE APPLIANCE OFF

Each time the appliance is turned off, it performs an automatic rinse cycle which cannot be interrupted.

 *Danger of burns!*

During rinsing, a little hot water flows from the coffee spouts. Avoid contact with splashes of water.

To turn the appliance off, press the  button (fig. 7). The appliance performs a rinse cycle, then goes off.

 *Please note!*

If the appliance is not used for an extended period, place the main switch in the 0 position (fig. 3).

 *Important!*

To avoid damaging the appliance, never place the main switch (fig. 3) in the 0 position while the appliance is on.

MENU SETTINGS

When you access the programming menu by pressing the **P** button, the following menu settings are available: Descale, Auto-off, Set temperature, Energy Saving, Water hardness, Install filter, Replace filter, Default values, Statistics.

Descale



For instructions on descaling, see page 16.

Auto-off

Please note

The appliance is set to turn off automatically if not used for 2 hours.

The time can be changed so that the appliance switches off after 15 or 30 minutes, or after 1, 2 or 3 hours.

1. Press the **P** button to enter the menu;
2. Turn the selection knob (fig. 8) until the  light comes on;
3. Press the  button to select the function;
4. Turn the selection knob until the lights corresponding to the number of hours before the appliance goes off automatically come on:

15 minutes     

30 minutes     

1 hour     



2 hours     

3 hours     

5. Press the  button to confirm;
 6. Press the  button to exit the menu.
- Auto-off is programmed.

Setting the temperature

To modify the temperature (low, medium, high) of the water used to make the coffee, proceed as follows:

1. Press the **P** button to enter the menu;
2. Turn the selection knob until the  light comes on;
3. Press the  button;
4. Turn the selection knob until the lights corresponding to the required temperature come on:

LOW     

MEDIUM     





HIGH     

5. Press the  button to confirm;
6. Press the  button to exit the menu.

Energy Saving

Use this function to enable or disable energy saving mode. When activated, it reduces energy consumption while the machine is on in compliance with current European regulations.

1. Press the **P** button to enter the menu;
2. Turn the selection knob until the light **E** comes on.

3. Press the  button. The **OK** light flashes.
 4. Press the  button to activate, or  to deactivate, the energy saving mode;
 5. Press the  button to exit the menu.
- When the function is active, the **E** light remains on.

Please note!

A few seconds may elapse between energy saving mode and delivery of the first coffee as the appliance must heat up again.

Setting water hardness

For instructions on setting water hardness, see page 17.

Install filter



For instructions on how to install the filter, see the section “Installing the filter” on page 17.

Replacing the filter

For instructions on how to replace the filter, see the section “Water softener filter” on page 17.





Default values (reset)

This resets all menu settings and programmed quantities back to the default values.

1. Press the **P** button to enter the menu;
2. Turn the selection knob until the  lights come on;
3. Press the  button. The **OK** light flashes;
5. Press the  button to confirm and exit.

Statistics function

This displays statistics relating to the machine. To display, proceed as follows:

1. Press the **P** button to enter the menu;
 2. Turn the selection knob until the  light comes on;
 3. Press the  button;
 4. When the selection knob is turned and the corresponding light flashes, the following information is displayed:
-  how many coffees have been made;
 -  how many times the machine has been descaled;
 -  the total number of litres of water delivered;

-  how many times the water softener filter has been replaced.
5. The quantities are indicated by the flashing beans as follows:



Example: you want to know how many coffees have been made. Enter the menu and select the  light. Count the flashes of the beans - 137 coffees have been made.

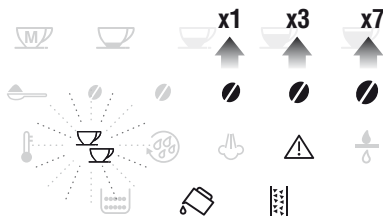

6. Press the  button twice to exit the menu.

MAKING COFFEE

Selecting the coffee taste

The appliance is set by default to make coffee with a standard taste.

You can also choose one of these tastes:



To change the taste, press the  button (fig. 9) repeatedly until the required taste appears.

Selecting the quantity of coffee in the cup

The appliance is set by default to make a standard quantity of coffee.





To select the quantity of coffee, turn the selection knob (fig. 8) until the light corresponding to the required quantity of coffee comes on:



Customizing the “my coffee” quantity

The appliance is set by default to automatically deliver 1oz/ 30ml of “my coffee”.

To modify the quantity, proceed as follows:

1. Place a cup under the coffee spouts (fig. 10).
2. Turn the selection knob (fig. 8) until the  light comes on.
3. Press the 1 cup button  (fig. 11) until the  light starts flashing and the appliance starts delivering coffee, then release the button.
4. As soon as the coffee in the cup reaches the required level, press the 1 cup button  (fig. 11) again.

The quantity of coffee in the cup has now been programmed.

Adjusting the coffee mill

The coffee mill is preset in the factory to make coffee correctly and should not require adjusting initially. However, if after making the first few coffees you find that the coffee is too thin and not creamy enough or that delivery is too slow (a drop at a time), this can be corrected by adjusting the grinding adjustment knob (fig. 12).

 *Please note!*

The grinding adjustment knob must only be turned when the coffee mill is in operation.

If the coffee is delivered too slowly or not at all, turn one click clockwise towards “7”.

For fuller bodied creamier coffee, turn one click counter-clockwise towards “1” (do not turn more than one click at a time otherwise the coffee could be delivered a drop at a time). These adjustments will only be evident after at least 2 cups of coffee have been delivered.

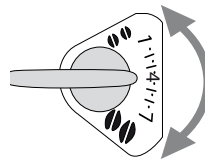

If this adjustment does not obtain the desired result, turn the knob another click.

Tips for a hotter coffee



For a hotter coffee, before delivery you are recommended to:

- rinse the appliance through by pressing the  button. Hot water flows out of the coffee spouts and heats the internal circuit of the machine so that the coffee delivered will be hotter.
- warm the cups with hot water (using the hot water function);
- select the “high” coffee temperature in the menu.

Making coffee using coffee beans





Important!

Do not use caramelized or candied coffee beans as they could stick to the coffee mill and make it unusable.

1. Fill the container with coffee beans (fig. 13).
2. Place under the coffee spouts:
 - 1 cup if you want one coffee (fig. 10);
 - 2 cups if you want 2 coffees.
3. Lower the spouts as near as possible to the cup. This makes a creamier coffee (fig. 14).
4. Press the button corresponding to the number of coffees required (1 cup  or 2 cups , figs. 11 and 15).
5. Preparation begins and the lights corresponding to the taste and quantity of coffee selected are displayed.

Once the coffee has been made, the appliance prepares for use again.

Please note:

- While the coffee maker is making coffee, delivery can be interrupted at any moment by pressing one of the two coffee buttons ( or )
- At the end of delivery, to increase the quantity of coffee in the cup, just press (within 3 seconds) one of the coffee buttons ( or )

Please note:

For hotter coffee, see the section “**Tips for a hotter coffee**”.

Important!

- If the coffee is delivered a drop at a time, too thin and not creamy enough or too cold, read the tips in the “Troubleshooting” section on page 21.
- Lights may be displayed on the control panel during use. Their meaning is given in the section “Explanation of the lights” on page 19.

Making coffee using pre-ground coffee



Important!

- Never add pre-ground coffee when the machine is off or it could spread through the inside of the machine and dirty it. This could damage the appliance.
- Never use more than 1 level measure or it could dirty the inside of the coffee maker or block the funnel.



Please note:

If you use pre-ground coffee, you can only make one cup of coffee at a time.

1. Press the  button repeatedly (fig. 9) until the  symbol appears.
2. Put one level measure of pre-ground coffee into the funnel (fig. 16).
3. Place a cup under the coffee spouts.
4. Press the 1 cup coffee button  (fig. 11).
5. Preparation begins.

MAKING CAPUCCINO

Important! Danger of burns

During preparation, steam is given off. Take care to avoid scalds.



1. When making cappuccino, prepare the coffee in a large cup;
2. Fill a container with about 3.4oz/ 100 grams of milk for each cappuccino to be made. In choosing the size of the container, bear in mind that the milk doubles or triples in volume.

Please note!

For a richer denser froth, use skimmed or partially skimmed milk at refrigerator temper-

perature (about 41°F/5°C).

To avoid milk with poor froth or large bubbles, always clean the cappuccino maker as described in the section “Cleaning the cappuccino maker after use”.

3. Press the  button. The  light flashes.
4. After a few seconds, the  light flashes telling you to turn the steam knob. Immerse the cappuccino maker in the milk container (fig. 17). Take care not to immerse the raised line on the cappuccino maker (shown by the arrow in fig. 18).
5. Turn the steam knob to the I position (fig. 4). Steam is delivered from the cappuccino maker, giving the milk a creamy frothy appearance and making it more voluminous.
6. To obtain a creamier froth, rotate the container with slow upward movements. You should not deliver steam for more than 3 minutes at a time.



Important! Danger of burns

Stop steam delivery before removing the container with the frothed milk to avoid burns caused by splashes of boiling milk.

7. Add the milk froth to the coffee prepared previously. The cappuccino is ready. Sweeten to taste and, if desired, sprinkle the froth with a little cocoa powder.

Cleaning the cappuccino maker after use.

Clean the cappuccino maker each time you use it to avoid the build-up of milk residues or blockages.



Important! Danger of burns

When cleaning the cappuccino maker, a little hot water comes out.

Avoid contact with splashes of water.

1. Discharge a little water for a few seconds by rotating the steam knob to the I position. Then turn the steam knob to the 0 position to stop the flow of hot water.
2. Wait a few minute for the cappuccino maker to cool down. Turn the cappuccino maker outwards and remove it by pulling it downwards (fig. 19).
3. Remove the nozzle downwards (fig. 20).

4. Make sure the two holes shown by the arrow in fig. 21 are not blocked. If necessary, clean with a pin.
5. Wash all parts of the cappuccino maker thoroughly with a sponge and warm water.
6. Replace the nozzle and put the cappuccino maker back on the nozzle (fig. 22), turning it and pushing it upwards until it is attached.

HEATING WATER



Important! Danger of burns.

Never leave the machine unsupervised while delivering hot water. Stop delivery of hot water as described below when the cup is full.

The cappuccino maker becomes hot while water is being delivered and must be held by the handle only. The hot water spout becomes hot while water is being delivered and must be handled by the handle only.

1. Place a container under the cappuccino maker as close as possible to avoid splashes.
2. Turn the steam knob to the I position. Delivery begins.
3. Stop by turning the steam knob to the 0 position.



Please note!

If “Energy Saving” mode is active, you may have to wait a few seconds before the hot water is delivered.

CLEANING

Cleaning the coffee maker

The following parts of the machine must be cleaned regularly:

- coffee grounds container (A13),
- drip tray (A17) and condensate tray (A14),
- water tank (A9),
- coffee spouts (A12),
- pre-ground coffee funnel (A6),
- inside of the machine, accessible after opening the infuser door (A10),
- infuser (A11).



Important!

- Do not use solvents, abrasive detergents or alcohol to clean the coffee maker. With De’Longhi superautomatic coffee makers, you need not use chemical products to

clean the machine.

The descaler recommended by De'Longhi is made from natural and completely biodegradable substances.

- None of the components can be washed in a dishwasher.
- Do not use metal objects to remove encrustations or coffee deposits as they could scratch metal or plastic surfaces.

Cleaning the coffee grounds container

When the  light flashes, the coffee grounds container must be emptied and cleaned.

Unless you clean the grounds container, the light will continue to flash and the appliance cannot be used to make coffee.

To clean (with the machine on):

- Remove the drip tray (fig. 23), empty and clean.
- Empty the grounds container and clean thoroughly to remove all residues left on the bottom.
- Check the condensate tray (red) and empty if necessary.

Important!

When removing the drip tray, the grounds container must be emptied, even if it contains few grounds.

If this is not done, when you make the next coffees, the grounds container may fill up more than expected and clog the machine.

Cleaning the drip tray and condensate tray

Important!

If the drip tray is not emptied regularly, the water could overflow from the edge and seep inside or around the coffee maker.

This could damage the machine, the surface it rests on or the surrounding area.

The drip tray is fitted with a level indicator (red) showing the level of water it contains (fig. 24).

Before the indicator protrudes from the cup tray, the drip tray must be emptied and cleaned.

To remove the drip tray:

1. Remove the drip tray and the grounds container (fig. 23);
2. Empty the drip tray and grounds container and wash them;

3. Check the condensate tray and empty if necessary.
4. Replace the drip tray and grounds container.

Cleaning the inside of the coffee maker

Danger of electric shock!

Before cleaning internal parts, the machine must be turned off (see "Turning off") and unplugged from the mains power supply.

Never immerse the coffee maker in water.

1. Check regularly (about once a week) that the inside of the appliance (accessible after removing the drip tray) is not dirty.
If necessary, remove coffee deposits with the brush and a sponge.
2. Remove the residues with a vacuum cleaner (fig. 25).

Cleaning the water tank

1. Clean the water tank (A9) regularly (about once a month and whenever you replace the water softener filter (if provided) with a damp cloth and a little mild washing up liquid.
2. Remove the filter (if present) and rinse with running water.
3. Replace the filter (if provided), fill the tank with fresh water and replace the tank.

Cleaning the coffee spouts

1. Clean the coffee spouts with a sponge or cloth (fig. 26A).
2. Check the holes in the coffee spout are not blocked.
If necessary, remove coffee deposits with a toothpick (fig. 26B).

Cleaning the pre-ground coffee funnel

Check regularly (about once a month) that the pre-ground coffee funnel is not blocked.

If necessary, remove coffee deposits with the brush supplied.

Cleaning the infuser

The infuser (A11) must be cleaned at least once a month.

⚠ Important!

The infuser may not be extracted when the machine is on.

1. Make sure the machine is correctly turned off (see "Turning the appliance off" on page 10).
2. Remove the water tank.
3. Open the infuser door (fig. 27) on the right side.
4. Press the two red release buttons inwards and at the same time pull the infuser outwards (fig. 28).

⚠ Important!

RINSE WITH WATER ONLY

NO DISHWASHING LIQUID - NO DISHWASHER

Clean the infuser without using dishwashing liquid as it could be damaged.

5. Soak the infuser in water for about 5 minutes, then rinse under the tap.
6. Use the brush to remove any coffee residues left in the infuser housing, visible through the infuser door.
7. After cleaning, replace the infuser by sliding it onto the internal support, then push the PUSH symbol fully in until it clicks into place.

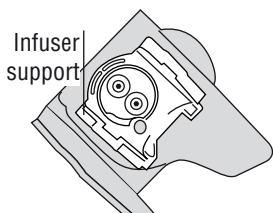

i Please note!

If the infuser is difficult to insert, before insertion, adapt it to the right size by pressing the two levers shown in the figure.

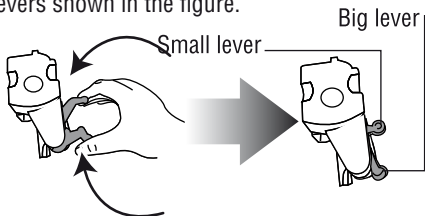

7. Once inserted, make sure the two red buttons have snapped out.
8. Close the infuser door.

9. Replace the water tank.

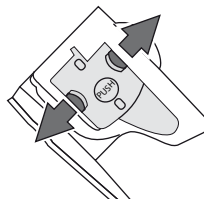

DESCALE

Descal the appliance when the  light on the control panel flashes.

⚠ Important!

Descaler contains acids which may irritate the skin and eyes.



It is vital to respect the manufacturer's safety warnings given on the descaler pack and the warnings relating to the procedure to follow in the event of contact with the skin and eyes.

i Please note!

Use De'Longhi descaler only.

Under no circumstances should you use sulphamic or acetic based descalers. Their use invalidates the guarantee.







Failure to descale the appliance as described also invalidates the guarantee.

1. Turn the machine on.
2. Press the **P** button to enter the menu.
3. Turn the selection knob until the  light is displayed.
4. Select by pressing the  button. The OK light flashes. Press the  button again to confirm.
5. Completely empty the water tank (A9) and remove the water softener filter (if present).
6. Pour the descaler into the tank up to the level A (corresponding to a 3.4oz/ 100ml pack) marked on the back of the tank (fig. 29A), then add water (3.4oz./ 100ml) up to level B (fig. 29B).
7. Place an empty container with a minimum capacity of 50oz/ 1,5l under the cappuccino maker (A19) (fig. 5).

⚠ Important! Danger of burns

Hot water containing acid flows from the cappuccino maker.

Avoid contact with splashes of water.

9. Press the  button to confirm introduction of the solution. The  light flashes telling you to turn the steam knob.
10. Turn the steam knob to the I position
The descaling program starts and the descaler liquid comes out of the cappuccino maker.
The descale program automatically performs a series of rinses and pauses to remove lime-scale deposits from inside the machine.
- After about 30 minutes, the water tank is empty. The OK and  lights come on and the  light flashes.
11. Empty the container used to collect the descaler solution and replace it under the cappuccino maker.
12. Remove the water tank, empty, rinse under running water, fill with clean water and replace. The  light goes off.
13. Hot water comes out of the cappuccino maker.
14. When the water tank is completely empty,  is displayed.
15. Turn the knob to the 0 position, insert the filter (if present), fill the water tank and the appliance is ready for use.

SETTING WATER HARDNESS







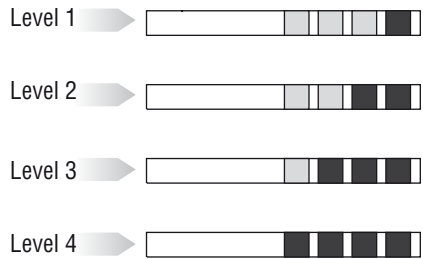

















The  light is displayed after a period of time established according to the water hardness set. The machine is factory set for a hardness value of 4. The machine can also be programmed according to the hardness of the mains water in the various regions so that the machine needs to be descaled less often.

Measuring water hardness

1. Remove the "TOTAL HARDNESS TEST" indicator paper attached to this manual from its pack.
2. Immerse the paper completely in a glass of water for one second.
3. Remove the paper from the water and shake lightly.
After about a minute, 1, 2, 3, or 4 red squares form, depending on the hardness of the water. Each square corresponds to one level.



Set water hardness

1. Press the **P** button to enter the menu.
2. Turn the selector knob until the  light is selected.
3. Confirm the selection by pressing the  button.
4. Turn the selection knob and set the level shown by the indicator paper (see previous paragraph).
LEVEL 1     
LEVEL 2     
LEVEL 3     
LEVEL 4     
5. Press the  button to confirm the setting.
6. Press the  button to exit the menu.
The machine is now reprogrammed with the new water hardness setting.

WATER SOFTENER FILTER

Certain models are fitted with a water softener filter. If this is not the case with your model, you are recommended to purchase one from De'Longhi Customer Services.

To use the filter correctly, follow the instructions below.

Installing the filter

1. Remove the filter from the packaging.
2. Turn the date indicator disk (see fig. 30) until the next 2 months of use are displayed.







 **Please note:**

The filter lasts about two months if the appliance is used normally. If the coffee maker is left unused with the filter installed, it will last a maximum of three weeks.

3. Remove the tank from the appliance and fill with water.
4. Insert the filter in the water tank and immerse it completely, sloping it to enable the air

- bubbles to escape (fig. 31).
5. Insert the filter in the filter housing (fig. 32A) and press as far as it will go.
 6. Close the tank with the lid (fig. 32B), then replace the tank in the machine.





When you install the filter, you must notify the appliance of its presence.



7. Press the **P** button to enter the menu;
8. Turn the selection knob until the  and  lights come on.
9. Press the  **OK** button.
10. Press the  button to confirm the selection.
11. Place a container (min. capacity: 100 ml) under the cappuccino maker.
12. Turn the steam knob and press the  button.
13. At the end of delivery, the  light flashes. Close the knob and the appliance returns automatically to the “ready for coffee” state.

The new filter is active and you can now use the coffee maker.

Replacing the filter





When the  light flashes, after two months (see date indicator) or when the appliance has not been used for 3 weeks, you should replace the filter:

1. Remove the old filter;
2. Remove the new filter from the packaging.
3. Turn the date indicator disk (see fig. 30) until the next 2 months of use are displayed (the filter lasts about two months);
4. Refill the tank;
5. Insert the filter in the water tank and immerse it completely, sloping it to enable the air bubbles to escape (fig. 31);
6. Place the filter in the filter housing (fig. 32A) and press as far as it will go. Close the tank with the lid (fig. 32B), then replace the tank in the machine;
7. Place a container (min. capacity: 100 ml) under the cappuccino maker.
8. Press the **P** button to enter the menu;
9. Turn the selection knob until the  and  lights come on.
10. Press the  button. The **OK** light flashes.
11. Press the  button to confirm the selection.

12. Turn the steam knob and press the  button.
13. At the end of delivery, the  light flashes. Close the knob and the appliance returns automatically to the “ready for coffee” state. The new filter is now active and you can use the coffee maker.

Removing the filter

If you want to continue using the appliance without a filter, you must remove it and notify the appliance of its removal as follows:

1. Extract the tank and exhausted filter;
2. Press the **P** button to enter the menu;
3. Turn the selection knob (fig. 8) until the  and  lights come on;
4. Press the  button. The **OK** light flashes;
5. Press the  button to confirm use of the appliance without the filter;
6. Press the  button to exit the menu.







TECHNICAL SPECIFICATION

Voltage:	120V~ 60Hz
Absorbed power:	1350W
Pressure:	15 bars
Water tank capacity:	50.7 fl. oz. max.
Size LxHxD:	2,38x3,4x4,3 in.
Cable length:	11 ft.
Weight:	20,22 lb.
Coffee beans container capacity:	5,3 oz. max.

EXPLANATION OF LIGHTS

LIGHT	POSSIBLE CAUSE	REMEDY
	Insufficient water in the tank.	Fill the tank with water and insert it correctly, pushing it as far as it will go until it clicks into place.
	The tank is not correctly in place.	Insert the tank correctly and press as far as it will go.
	The grounds container (A13) is full.	Empty the grounds container and drip tray, clean and replace. Important: when removing the drip tray, the grounds container MUST be emptied, even if it contains few grounds. If this is not done, when you make the next coffee, the grounds container may fill up more coffee than expected and clog the machine.
	After cleaning, the grounds container has not been replaced.	Remove the drip tray and insert the grounds container.
	The grinding is too fine and the coffee is delivered too slowly or not at all.	Repeat coffee delivery and turn the grinding adjustment knob (fig. 10) one click clockwise towards "7" while the coffee mill is in operation. If after making at least 2 coffees delivery is still too slow, repeat the correction procedure, turning the grinding adjustment knob another click until delivery is correct (see the section: Adjusting the coffee mill on page 29). If the problem persists, turn the steam knob to the I position and deliver water from the cappuccino maker.



LIGHT	POSSIBLE CAUSE	REMEDY
	<p>The "pre-ground coffee" function has been selected without placing any pre-ground coffee in the funnel.</p>	<p>Place pre-ground coffee in the funnel or deselect the "pre-ground" function.</p>
	<p>The machine must be descaled.</p>	<p>The descaling procedure described in the section "Descaling" needs to be performed as soon as possible.</p>
	<p>Too much coffee has been used.</p>	<p>Select a milder taste or reduce the quantity of pre-ground coffee then make the coffee again.</p>
	<p>The coffee beans have run out.</p>	<p>Fill the beans container</p>
	<p>The pre-ground coffee funnel is clogged.</p>	<p>Empty the funnel with the help of a brush as described in the section "Cleaning the pre-ground coffee funnel".</p>
	<p>The infuser has not been replaced after cleaning.</p>	<p>Insert the infuser as described in the section "Cleaning the infuser".</p>
	<p>The inside of the appliance is very dirty.</p>	<p>Clean the inside of the appliance thoroughly, as described in the section "Cleaning and maintenance". If the message is still displayed after cleaning, contact customer service.</p>
	<p>The filter needs to be replaced.</p>	<p>Replace the filter (see the section "Replacing the water softener filter").</p>

TROUBLESHOOTING

Below is a list of some of the possible malfunctions.

If the problem cannot be resolved as described, contact Customer Service.

PROBLEM	POSSIBLE CAUSE	REMEDY
The coffee is not hot	The cups were not preheated.	Warm the cups by rinsing them with hot water (Please note you can use the hot water function).
	The infuser has cooled down because 2-3 minutes have elapsed since the last coffee was made.	Before making the coffee, warm the infuser by pressing the  button.
	Low coffee temperature is set.	In the menu, set a high coffee temperature.
The coffee is thin or not creamy enough.	The coffee is ground too coarsely.	Turn the grinding adjustment knob one click counter-clockwise towards "1" while the coffee mill is in operation (fig. 10). Continue one click at a time until coffee delivery is satisfactory. The effect is only visible after delivering two coffees (see "Adjusting coffee mill", page 12).
	The coffee is unsuitable.	Use pre-ground or coffee beans for espresso coffee makers
The coffee is delivered too slowly or a drop at a time.	The coffee is ground too finely.	Turn the grinding adjustment knob one click clockwise towards "7" while the coffee mill is in operation (fig. 10). Continue one click at a time until coffee delivery is satisfactory. The effect is only visible after delivering 2 coffees (see the section: "Adjusting the coffee mill" on page 12).
Coffee does not come out of one of the spouts.	The spouts are blocked.	Clean the spouts with a toothpick.
The frothed milk has large bubbles	The milk is not cold enough or is not semi-skimmed.	You should ideally use skimmed or semi-skimmed milk at refrigerator temperature (about 41°F/ 5°C). If the result is still disappointing, try another brand of milk.
The milk is not frothed	Cappuccino maker is dirty	Clean as described in the section "Cleaning the cappuccino maker after use" on page 31.
Steam delivery stops	A safety device stops steam delivery after 3 minutes.	Wait, then activate the steam function again.
The appliance does not come on.	It is not plugged into the mains socket.	Plug into the mains socket.
	The main switch is in 0 position.	Place the main switch in the I position (fig. 1).

LIMITED WARRANTY

This warranty applies to all products with De'Longhi or Kenwood brand names.

What does the warranty cover?

We warrant each appliance to be free from defects in material and workmanship. Our obligation under this warranty is limited to repair at our factory or authorized service center of any defective parts or part thereof, other than parts damaged in transit. In the event of a products replacement or return, the unit must be returned transportation prepaid. The repaired or new model will be returned at the company expense.

This warranty shall apply only if the appliance is used in accordance with the factory directions, which accompany it, and on an Alternating current (AC) circuit.

How long does the coverage last?

This warranty runs for two years (2) from the purchase date found on your receipt and applies only to the original purchaser for use.

What is not covered by the warranty?

The warranty does not cover defects or damage of the appliance, which result from repairs or alterations to the appliance outside our factory or authorized service centers, nor shall it apply to any appliance, which has been subject to abuse, misuse, negligence or accidents. Also, consequential and incidental damage resulting from the use of this product or arising out of any breach of contract or breach of this warranty are not recoverable under this warranty. Some states do not allow the exclusion or limitation of incidental or consequential damage, so the above limitation may not apply to you.

How do you get service?

If repairs become necessary, see contact information below:

U.S. Residents: Please contact our toll free hotline at 01-866-528-8323 (01-866-Latte-Best) or log onto our website at www.delonghi.com.

Residents of Canada: Please contact our toll free hotline at 01-888-335-6644 or log onto our website at www.delonghi.com.

Residents of Mexico: Please contact our toll free number 01-800-711-8805 for assistance or log onto our website at www.delonghi.com.

The above warranty is in lieu of all other express warranties and representations. All implied warranties are limited to the applicable warranty period set forth above. This limitation does not apply if you enter into an extended warranty with De'Longhi. Some states/countries do not allow limitations on how long an implied warranty lasts, so the above exclusions may not apply to you. De'Longhi does not authorize any other person or company to assume for it any liability in connection with the sale or use of its appliance.

How does country law apply?

This warranty gives you specific legal rights, and you may also have other rights, which vary from state to state/country to country.

Free Manuals Download Website

<http://myh66.com>

<http://usermanuals.us>

<http://www.somanuals.com>

<http://www.4manuals.cc>

<http://www.manual-lib.com>

<http://www.404manual.com>

<http://www.luxmanual.com>

<http://aubethermostatmanual.com>

Golf course search by state

<http://golfingnear.com>

Email search by domain

<http://emailbydomain.com>

Auto manuals search

<http://auto.somanuals.com>

TV manuals search

<http://tv.somanuals.com>