



INSTALLATION and SERVICE INSTRUCTIONS  
USE and CARE INSTRUCTIONS

**DOMINO**  
INDUCTION HOB  
model **DE302IB**



distributed by  
**DèLonghi**  
Pty Ltd

***Dear Customer,***

*Thank you for having purchased and given your preference to our product.*

*The safety precautions and recommendations reported below are for your own safety and that of others. They will also provide a means by which to make full use of the features offered by your appliance.*

*Please keep this booklet in a safe place. It may be useful in future, either to yourself or to others in the event that doubts should arise relating to its operation.*

***This appliance must be used only for the task it has explicitly been designed for, that is for cooking foodstuffs. Any other form of usage is to be considered as inappropriate and therefore dangerous.***

***The manufacturer declines all responsibility in the event of damage caused by improper, incorrect or illogical use of the appliance or by faulty installation.***

## PRODUCT LABEL

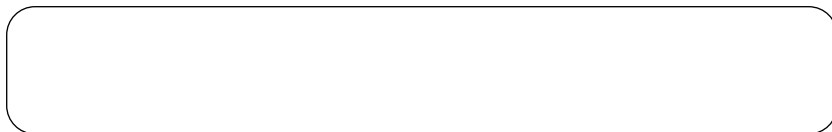

---

This cooktop has been designed and constructed in accordance with the following codes and specifications:

- AS/NZS 60335.1      General Requirements for Domestic electrical appliances
- AS/NSZ 60335.2.6    Particular Requirements for Domestic electrical cooking appliances
- AS/NZS CISPR 14.1    Electromagnetic Compatibility Requirements.

## **BEFORE USING FOR THE FIRST TIME**

- Read the instructions carefully before installing and using the appliance.
- After unpacking the appliance, make sure it is not damaged. In case of doubt, do not use the appliance and contact your supplier or a qualified engineer.
- Remove all packaging and do not leave the packing material (plastic bags, polystyrene, bands etc) in easy reach of children as they may cause serious injury. The packaging materials are recyclable.
- The appliance should be installed and all the electrical connections made by a qualified engineer in compliance with local regulations in force and following the manufacturer's instructions.
- Do not attempt to modify the technical properties of the appliance, as it may become dangerous to use.

## IMPORTANT SAFEGUARDS & RECOMMENDATIONS

- Do not carry out any cleaning or maintenance without first disconnecting the appliance from the electrical supply.
- During and after use of the hob, certain parts will become hot. Do not touch hot parts.
- After use always ensure that the controls are in the **OFF** position.
- Household appliances are not intended to be played with by children.
- Keep children away from the hob during use.
- Children, or persons with a disability which limits their ability to use the appliance, should have a responsible person to instruct them in its use. The instructor should be satisfied that they can use the appliance without danger to themselves or their surroundings.
- **WARNING**  
When correctly installed, your product meets all safety requirements laid down for this type of product category. However special care should be taken around the underneath of the appliance as this area is not designed or intended to be touched and may contain sharp or rough edges, that may cause injury.
- **Fire Risk!** Do not leave inflammable materials on the Hob top.
- Make sure that electrical cords connecting other appliances in the proximity cannot come in to contact with the Hob top.
- Do not allow heavy or sharp objects to drop on the glass ceramic hob.
- Do not scratch the hob with sharp objects. Don't use the hob as a work surface.
- Before disposing of an unwanted appliance, it is recommended that it is made inoperative and that all potentially hazardous parts are made harmless.
- **Important:** This appliance has been designed for domestic use only. The appliance is NOT suitable for use within a semi-commercial, commercial or communal environment.
- **If the supply cord is damaged, it must be replaced by the manufacturer or its service agent or a similarly qualified person in order to avoid a hazard.**
- Do not operate your appliance by means of an external timer or separate remote-control system.
- Do not place or leave empty pans on the glass ceramic hob.
- Metallic objects such as knives, forks, spoons and lids should not be placed on the hob surface since they can get hot.
- Do not use metallic kitchen utensils (e.g. ladles). It is preferable to use plastic or wood kitchen utensils.
- Please use pans of recommended size (see minimum pan diameter recommended). It is not advisable to use pans smaller than the cooking zone. The pans have to be placed in the centre of the cooking zone.
- Do not use defective pans or pans with a curved bottom.
- Please use suitable pans marked for induction cooking.
- Please keep your distance from the electromagnetic fields by standing 5-10 cm from the cooking zones. When possible use the rear cooking zone.
- Magnetic objects (e.g. credit cards, floppy disks, memory cards) and electronic instruments (e.g. computers) should not be placed near the induction hob.
- **IMPORTANT WARNING: The induction hob complies with the applicable Standards for domestic cooking appliances. Therefore it should not interfere with other electronic units. Persons with cardiac pacemakers or any other electrical implants must check with their doctor if they can use an induction cooking system (and check any possible interferences with the implants).**
- **Attention: Detach the appliance from the mains if the ceramic glass is cracked and contact the After-Sales Service.**

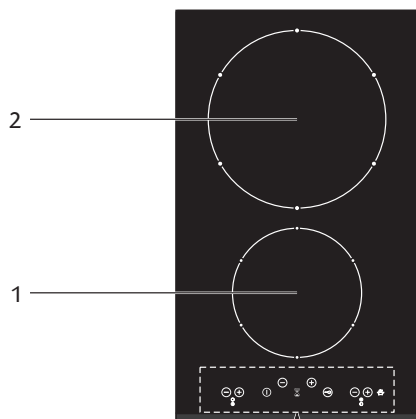
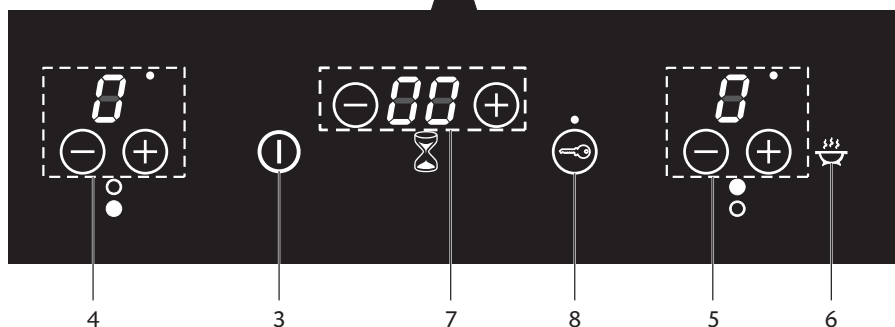

Fig. 1.1



## Electrical insulation Class I

### COOKING ZONES

1. Induction cooking zone Ø 140 mm - 1400 W
2. Induction cooking zone Ø 210 mm - 2200 W (3000 W with Booster function)

### TOUCH-CONTROL DESCRIPTION

3. ON/OFF key
4. Front zone (1) keys (increasing and decreasing power)
5. Rear zone (2) keys (increasing and decreasing power)
6. Booster function (rear zone only) (2)
7. Automatic cooking timer keys
8. Child lock selection

**Notes:**

- Each selection (by pressing one of the keys) is indicated by an acoustic signal (beep).
- User interface initial calibration: this feature is for the keyboard calibration, to adapt the sensibility of the keys to the final mechanical, environmental and user conditions.

Any time the cooktop is connected to the electrical supply or after a power failure (that generates a reset in the user interface), the first time the Key-Lock  is touched the sensibility of the keyboard is readjusted.

The first touch of the Key-Lock  must be done in certain condition: do not use gloves, use a clear finger.

It is also important to consider that the calibration process requires a low level of ambient light in the area of the touch keys. If the environmental light conditions are excessive (e.g. halogen hood light/s on), the user interface calibration is suspended and the cooking zones displays show “F” and “L” alternating - error message “FL”) until the correct light conditions will be recovered.

In this case the direct environmental light/s must be switched off before calibrating the cooktop; then, after completing the process, the light/s can be switched on again.

- The touch control is switched off automatically (and a warning beep sounds every 10 seconds):
  - if one or more keys are touched for more than 10 seconds;
  - if an object is positioned on the touch control area;
  - in the case of spillage of liquids on the control keys.
- When the touch control reaches an ambient temperature above a preset temperature the heating elements are automatically switched off (the displays show “F” and “c” alternating - error message “Fc”). In this case let the cooktop cool down before using again.

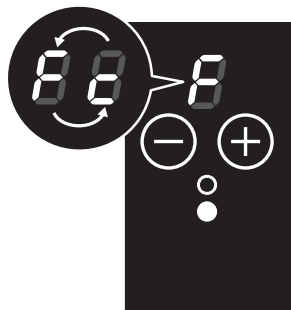
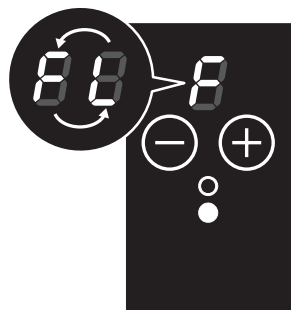
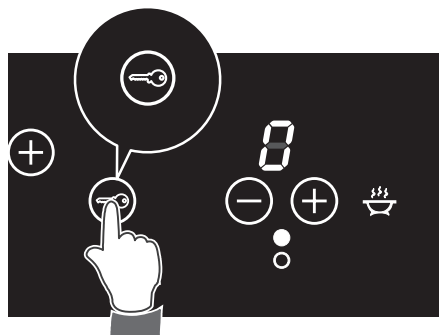

## THERMAL PROTECTION

The induction cooktop is fitted with safety devices to protect the electronic system and each cooking zone from overheating.

### OVERHEATING OF COOKING ZONE

- **Cooking zone OFF:** the cooking zone display shows “H” and “E” alternating or just “E” blinking.
  - **Cooking zone ON:** the cooking zone display alternates between set power level and “E”.
- No power is delivered to the cooking zone.

**Let the cooking zone cool down before using.**

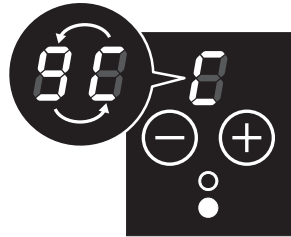
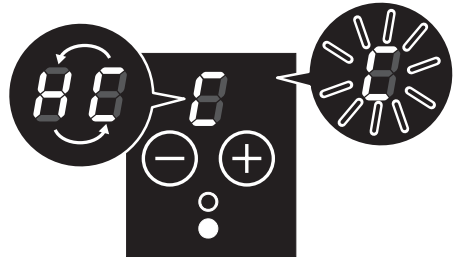

### OVERHEATING OF INDUCTION GENERATOR

- **Cooking zone OFF:** the cooking zone display shows “H” and “c” alternating or just “c” blinking.
  - **Cooking zone ON:** the cooking zone display alternates between set power level and “c”.
- No power is delivered to the cooking zone.

**Let the cooking zone cool down before using.**

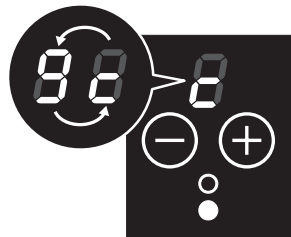
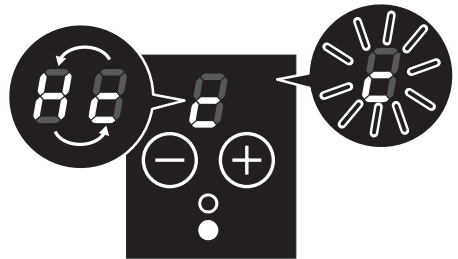

The ceramic cooktop is fitted with induction cooking zones. These zones, shown by painted disks on the ceramic surface, are controlled by a touch control system.

## INDUCTION COOKING SYSTEM

When your induction hob is switched on and a cooking zone has been selected, the electronic circuits produce induced currents that instantaneously heat the bottom of the pan which then transfers this heat to the food.

Cooking takes place with hardly any energy loss between the induction hob and the food. Your induction hob operates only if a correct pan with the right features is placed on a cooking zone. Please refer to "Cookware for Induction Cooking".

## COOKWARE FOR INDUCTION COOKING

The induction cooking system OPERATES ONLY if using correct cookware suitable for induction cooking.

The bottom of the pan has to be ferromagnetic to generate the electromagnetic field necessary for the heating process (meaning a magnet has to stick to the bottom of the pan).

Pans made from the following materials are not suitable:

- glass, wood, porcelain, ceramic, stoneware;
- pure stainless steel, aluminium or copper without magnetic bottom.

To check if a pan is suitable or not:

- Test the bottom of the pan with a magnet: if the magnet sticks, the pan is suitable.
- If a magnet is not available pour a small amount of water inside the pan and place the pan on a cooking zone. Switch on the cooking zone: if the set power level flashes on the cooking zone display, the pan is not suitable (then after 1 minute, the power level automatically returns to "0").

**Important note:** the cooking zones will not operate if the pan diameter is too small. To correctly use the cooking zones follow the indications given in the following table.

Induction Cooking Zone	Minimum Pan Diameter Recommended (referred to the bottom of the pan)
Front zone, Ø 145 mm	80 mm
Rear zone, Ø 210 mm	130 mm

**Pay attention:** The pan shall always be centred over the middle of the cooking zone. It is possible to use oversized pans but its bottom shall not touch the other cooking zone. Always use pans with thick, completely flat bottom. Do not use pans with concave or convex bottom; these could cause overheating of the cooking zone.

**Note:** Some types of pans could cause noise when used on an induction cooking zone. The noise does not mean any failure on the appliance and does not influence the cooking operation.



## HOW TO TURN THE TOUCH CONTROL ON AND OFF

### Switching ON

Press the key  and keep it pressed until the touch control is lighted.

The displays of the cooking zones read “0”.

#### Notes:

- If the safety key-lock protection is active, the touch control can be turned **ON** only after having deactivated this protection.
- Auto switch-off: If a cooking zone is not turned **ON** within 10 seconds, the touch control will automatically switch off.

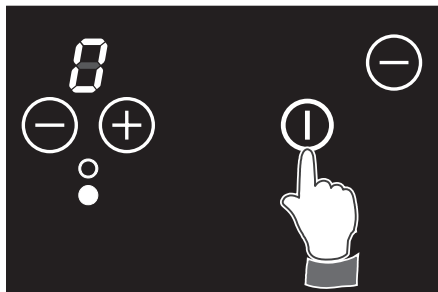

### Switching OFF

The touch control may be switched **OFF** at any time by pressing the key .

If any cooking zones are turned **ON**, they will be turned **OFF**.

## POWER IGNITION AND ADJUSTMENT OF A COOKING ZONE

To turn **ON** a cooking zone the touch control must be switched **ON** (see section “How To Turn the Touch Control ON and OFF”).

Press the key  $\oplus$  and keep it pressed until the desired power level, ranging between 1 and 9 is set.

As an alternative, press the key  $\ominus$ .

The choice starts from level 9 (maximum level) down to 1 (minimum level).

To reset the power level press the key  $\ominus$  and keep it pressed until power level zero (0) or alternatively press the keys  $\oplus$  and  $\ominus$  at the same time.

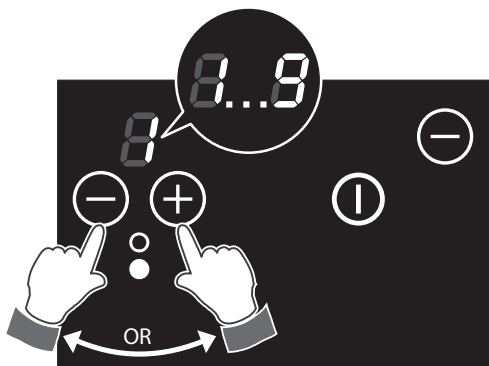

## AFTERHEAT IN COOKING ZONE/S

When switching off a cooking zone (power level 0), if the temperature of the zone is too warm to be touched the display will show alternately “H” and “0”. Whenever the touch control is switched off, the residual heat is shown by a static “H”.

Avoid touching the hob surface over the cooking area. Please pay special attention to children.

It is still possible to start cooking again; just set the required power level.

“H” is turned **OFF** when the cooking zone temperature drops below a preset temperature.

Cooking zone power level	Front zone Watt power	Rear zone Watt power
1	75 W	100 W
2	150 W	200 W
3	300 W	300 W
4	400 W	500 W
5	500 W	700 W
6	600 W	900 W
7	800 W	1100 W
8	1000 W	1600 W
9	1400 W	2200 W

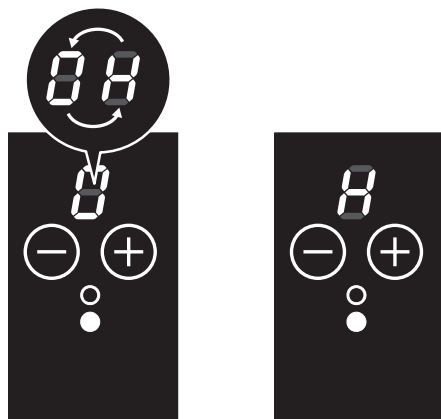

## BOOSTER FUNCTION REAR COOKING ZONE ONLY

This function allows the cooking zone to operate at the **Booster** maximum power (above the nominal power) for maximum 10 minutes; it could be used, for example, to rapidly heat up large amount of water.



**This function is available for the rear cooking zone only.**

To activate the **Booster** function, the touch control must be switched ON (see section "How to Turn the Touch Control ON and OFF").

With the zone at any power level (0...9), just touch the key  until the rear zone display shows "P".

At the end of the **Booster** program (10 minutes) the rear zone is automatically set to the power level "9".

With the zone at the **Booster** level:

- if touching again the key  - a beep sounds, the heat up program is cancelled and the power level set to "9";
- if touching the key  - an error beep sounds but none change is performed;
- if touching the key  - a beep sounds, the heat up program is cancelled and the power level set to "9".

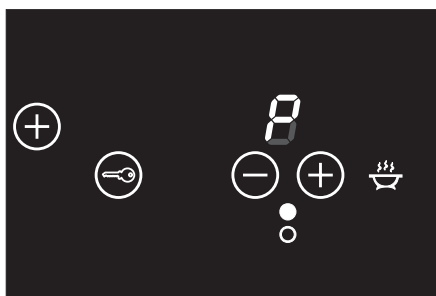
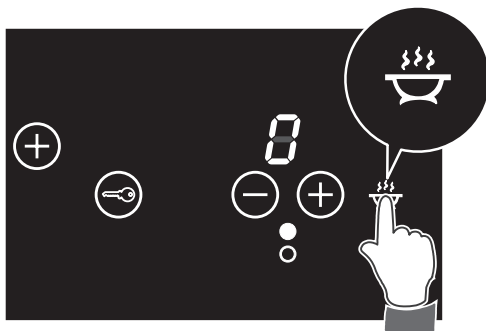

## INDUCTION HEATERS POWER MANAGEMENT

The maximum power of the cooktop is limited to 3600 W.

This means that the electronic interface automatically manages the power levels of the heaters in order to not exceed the maximum power limit (see also table on the previous page).

- Both the zones can be used, at the same time, from power levels "7" to "9";
- With the front zone set to power level "7", "8" or "9", if setting the **Booster** program on the rear zone the power level of the front zone is automatically reduced to "6".
- With the **Booster** program set on the rear zone, if setting the power level "7", "8" or "9" on the front zone the power level of the rear zone is automatically reduced to "9".

## SAFETY KEY-LOCK TO PROTECT CHILDREN

This function locks the touch-control keys against unwanted activation.

To activate the key-lock press the key ; the indicator light above the key symbol will light up.

- Cooking zone/s operating (power level already set) - with the key-lock protection active it is only possible to switch off the cooktop.
- Cooktop off - with the key-lock protection active it is not possible to use the cooktop. To use the cooktop deactivate this protection.

To deactivate the key-lock protection just press the key ; the indicator light above the key symbol will go out.

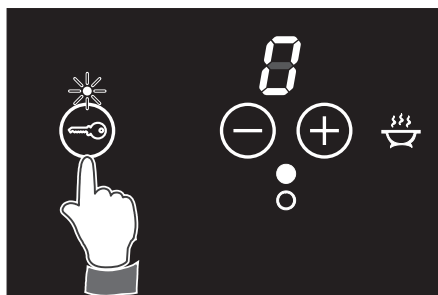

## PROGRAM FOR AUTOMATIC SWITCHING OFF OF ONE COOKING ZONE

This function permits to set a timer from 1 to 99 minutes for automatic turning OFF of one cooking zone only.

**Note:** It is not possible to set this program for both the cooking zones.

With the touch control switched **ON**:

- Press the timer keys (+) or (-); a beep sounds and the timer display shows "00". The displays of the cooking zones show "E" (timer).
- Within 10 seconds, select the cooking zone to be programmed by using the cooking zone keys (+) or (-); a beep sounds and the led next to the heater display start blinking.
- Set the desired power level by using the cooking zone keys (+) or (-); the led next to the heater display is stably lit (not blinking).
- Within 10 seconds, set the timer by using the timer keys (+) or (-) to increase or reduce the value (when touching the keys, the led next to the heater display is blinking). If the selected time is "00", the timer is switched off automatically after 10 seconds.
- The countdown starts 10 seconds after the last selection. The time can be changed at any time by using the timer keys; the countdown stops and then the timer changes the stop time.

Now the program for automatic switching off is complete.

At the end of the countdown the cooking zone will switch off automatically, an acoustic signal (beep) will sound (for one minute only), "00" will flash on the timer display and the led next to the heater display will blink.

Press any button of the touch control to reset the timer.

**Note:** The program for automatic switch off can be cancelled at any time by resetting the timer to "00".

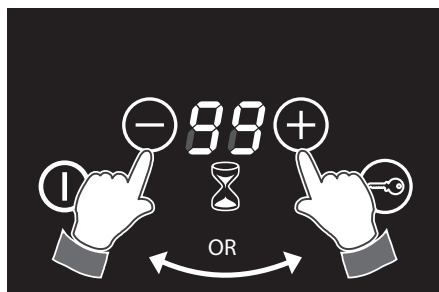
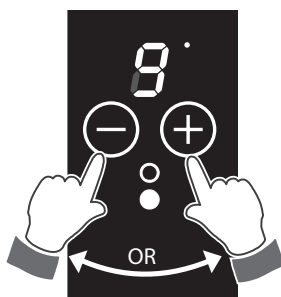
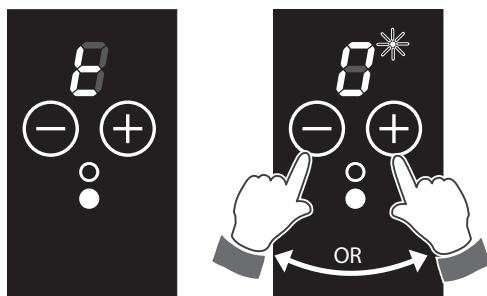
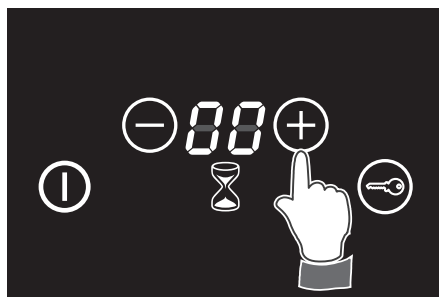

## OPERATION TIME LIMIT OF COOKING ZONES

Each cooking zone is automatically switched **OFF** after a maximum preset time if no operation is performed.

The maximum preset time limit depends on the set power level, as illustrated in this schedule.

Each operation on the cooking hob by using the keys ⊕, ⊖ will reset the maximum operation time at its initial value.

Cooking zone power level	Operation time limit
1	10 hours
2	5 hours
3	5 hours
4	4 hours
5	3 hours
6	2 hours
7	2 hours
8	2 hours
9	1 hour
P Booster (rear zone only)	10 minutes

## ERROR CODE ON THE DISPLAY/S

If an error message appears on the display/s (the display/s show/s “ F ” and another character alternating - e.g. “ F ” and “ R ”, “ F ” and “ 0 ”, .....):

1. Disconnect the cooktop from the mains.
2. Reconnect the cooktop and turn it on.
3. Wait for about two minutes and if the problem does not appear the cooktop can be used.
4. If the problem does not disappear repeat step from 1 to 3.
5. If the problem continues, disconnect the cooktop from the mains and contact your Authorised Service Centre.

**Important:** In the case of error message “ F ” and “ L ” or “ F ” and “ C ” see notes at page 6.

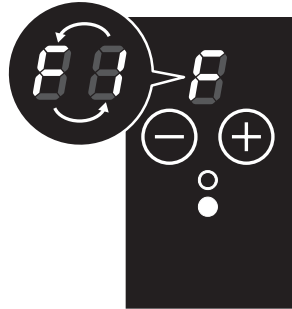
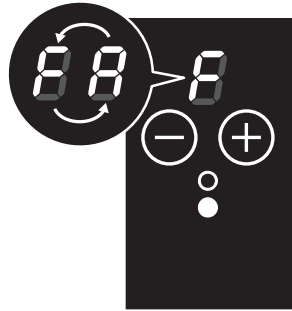

## DISPLAY/S OFF OR NOT CORRECTLY OPERATING

**If a display or the displays are only partially lit or not lit.**

1. Switch off the cooktop and disconnect it from the mains.
2. Reconnect the cooktop and turn it on.
3. Wait for about two minutes and if the problem does not appear the cooktop can be used.
4. If the problem does not disappear repeat step from 1 to 3.
5. If the problem continues, disconnect the cooktop from the mains and contact your Authorised Service Centre.

## CLEANING THE CERAMIC HOB

**Before you begin cleaning make sure that the hob is switched off.**

- Remove spillages and other types of incrustations.
- Dust or food particles can be removed with a damp cloth.
- If you use a detergent, please make sure that it is not abrasive or scouring. Abrasive or scouring powders can damage the glass surface of the hob.
- All traces of the cleaner must be removed with a damp cloth.
- Dust, fat and liquids from food that has boiled over must be removed as soon as possible.
- If they are allowed to harden they become increasingly difficult to remove.  
**This is especially true in the case of sugar/syrup mixtures which could permanently pit the surface of the hob if left to burn on it.**
- If any of these products has melted on the ceramic surface, you should remove it immediately (when the surface is still hot) by using a scraper to avoid any permanent damage to the surface of the hob (available under part no. 103138).
- Do not put articles on the hob which can melt: i.e plastic, aluminium foil, sugar, sugar syrup mixtures etc.
- Avoid using a knife or other sharp utensil as these may damage the ceramic surface.
- Do not use steel wool or an abrasive sponge which could scratch the surface permanently.
- Do not use cleaning products with a chlorine or acidic base.

## SIDE STAINLESS STEEL TRIMS

- Stainless steel parts must be rinsed with water and dried with a soft and clean cloth.
- For persistent dirt, use specific non-abrasive products available commercially or a little hot vinegar.

**Do not use harsh abrasive cleaners or sharp metal scrapers to clean the glass since they can scratch the surface, which may result in shattering of the glass.**

**Do not use a steam cleaner because the moisture can get into the appliance thus make it unsafe.**

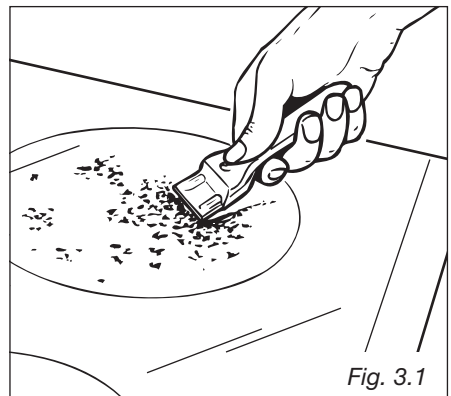



# **ADVICE FOR THE INSTALLER**

**CAUTION:**

- This appliance shall only be serviced by authorized personnel.
- This appliance is to be installed only by an authorised person according to the current local regulations and in observation of the manufacturer's instructions.
- Incorrect installation, for which the manufacturer accepts no responsibility, may cause personal injury or damage.
- Always disconnect the cooktop from mains power supply before carrying out any maintenance operations or repairs.

**WARNING !**

- We would point out that the adhesive which bonds the plastic laminate to the furniture must withstand temperatures not less than 150 °C to avoid delamination.
- The appliance must be housed in heat resistant units.
- The walls of the units must be capable of resisting temperatures of 75 °C above room temperature.

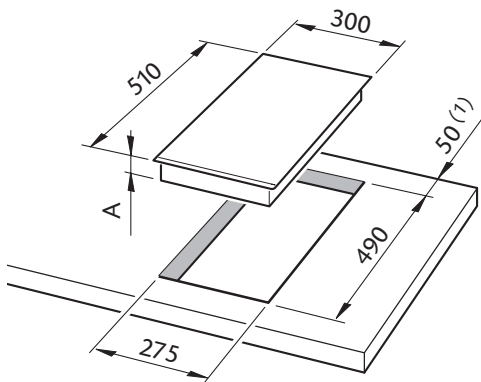

Fig. 4.1

A	50 mm	from the top of countertop to bottom metal cover
	68 mm	from the top of countertop to terminal block

(1): at least 50 mm between the back side of the cut-out and the back of the countertop.

This cooktop can be built into a working surface 30 to 40 mm thick and 600 mm deep.

In order to install the ceramic hob into the kitchen fixture, a hole with the dimensions shown in figure 4.1 has to be made, keeping in consideration the following:

- The cooktop shall not be installed directly above a dishwasher, fridge, freezer, washing machine or clothes dryer, as the humidity may damage the cooktop electronics.
- If the cooktop is installed above an oven, the oven shall be provided with cooling fan. The two appliances should be connected to the electrical supply with independent connections.

**- IMPORTANT WARNING! This cooktop requires adequate supply of fresh, cool air to fully function. The base of the cooktop must have direct unrestricted ventilation to the room where the cooktop is installed. Follow the requirements of figure 4.3.**

- The ceramic hob must be kept no less than 60 mm away from any side wall.

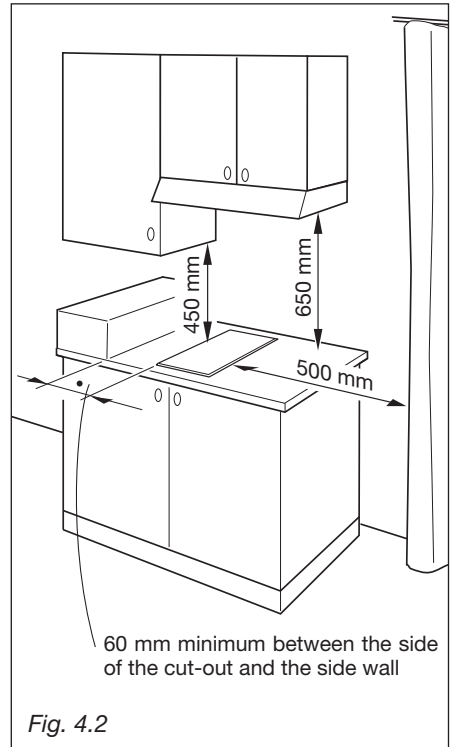

- The rear wall must be at least 50 mm from the ceramic hob.
- There must be a distance of at least 650 mm between the hob and any wall cupboard or extractor hood positioned immediately above (see fig. 4.2).
- The coatings of the walls of the unit or appliances near the cooktop must be heat resistant.
- **Do not install the appliance near inflammable materials (eg. curtains).**

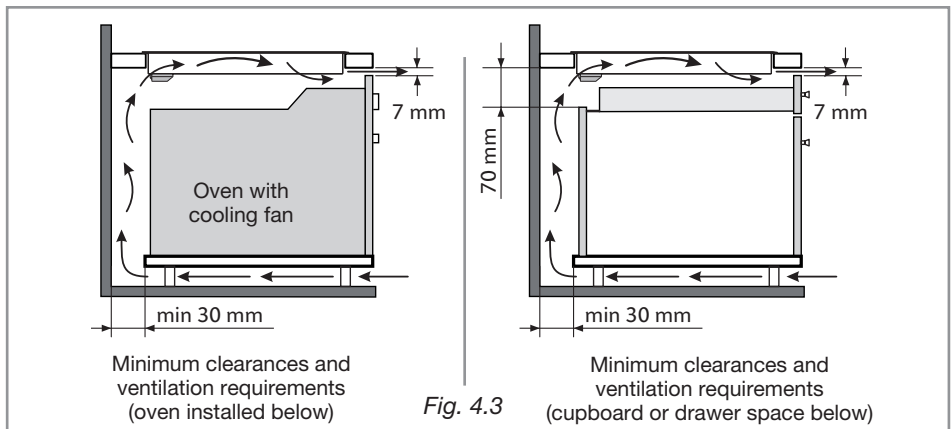



**IMPORTANT:** Installation must be carried out according to the manufacturer's instructions. Incorrect installation may cause harm and damage to people, animals or property, for which the manufacturer accepts no responsibility.

**Before carrying out any work on the electrical section of the appliance, it must be disconnected from the mains.**

**Connection to a good earth wiring system is absolutely essential.**

**The manufacturer accepts no responsibility for any inconvenience caused by failure to comply with this rule.**

## **ELECTRICAL REQUIREMENTS**

- Connection to the electric power supply must be carried out by a qualified technician and following the appropriate safety regulations.
- The appliance must be connected to the mains checking that the voltage corresponds to the value given in the rating plate and that the electrical cable sections can withstand the load specified on the plate.
- If the hob is supplied without plug, fit a standard plug which is suitable for the power absorbed by the appliance and in conformity with the local rules in force.
- The plug must be put into a socket connected to the earth system in compliance with safety rules.
- A suitable isolating switch providing full disconnection from the mains power supply (under overvoltage category III conditions) shall be incorporated in the permanent wiring, mounted and positioned to comply with the local wiring rules and regulations. The isolating switch must be of an approved type and provide a 3 mm air gap contact separation in all poles (or in all active [phase] conductors if the local wiring rules allow for this variation of the requirements).
- The power supply cable must not touch the hot parts and must be positioned so that it does not exceed 50°C above ambient.
- Once the appliance has been installed, the power switch or power plug must always be in a accessible position.

**N.B. For connections to the mains power supply, never use adaptors, reductions or multiple power points as these may overheat and catch fire.**

In the event that installation should require modifications to the mains supply wiring system, it is recommended that a qualified technician be called to carry out substitution. The technician will also have to verify that the cross-section of the electric cables on the power point match the appliance's power rating.

**If the hob surface is cracked disconnect the appliance from the mains and contact the After-Sales Service.**

**Replacing the power cord must be done by a qualified electrician in accordance with the instructions supplied by the manufacturer and in compliance with established electrical regulations.**

## CONNECTING OF THE POWER SUPPLY CABLE

- Unhook the terminal board cover by inserting a screwdriver into the two hooks **A** (fig. 5.1).
- Open the cable gland by unscrewing screw **F** (fig. 5.3), unscrew the terminal screws and remove the cable.
- The new supply cable, of suitable type and section, is connected to the terminal board following the diagram of fig. 5.2.

### FEEDER CABLE SECTION "Type H05RR-F"

230-240 V ~      3 x 1.5 mm<sup>2</sup>      3600 W MAX (15.6 A)

**WARNING:** If the power supply cable is damaged, it must be replaced only by an authorised service agent in order to avoid a hazard.

230-240 V ~

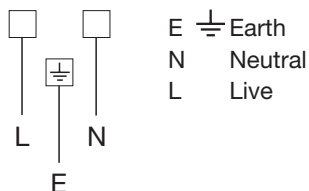
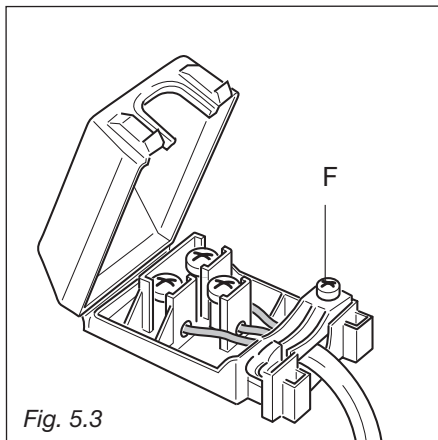
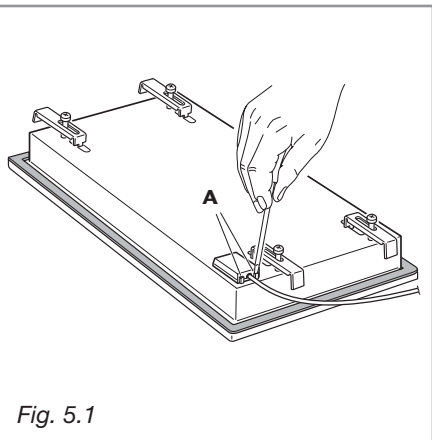

Fig. 5.2



Descriptions and illustrations in this booklet are given as simply indicative. The manufacturer reserves the right, considering the characteristics of the models described here, at any time and without notice, to make eventual necessary modifications for their construction or for commercial needs.



*Living innovation*

cod. 1103762 - B1



## Free Manuals Download Website

<http://myh66.com>

<http://usermanuals.us>

<http://www.somanuals.com>

<http://www.4manuals.cc>

<http://www.manual-lib.com>

<http://www.404manual.com>

<http://www.luxmanual.com>

<http://aubethermostatmanual.com>

Golf course search by state

<http://golfingnear.com>

Email search by domain

<http://emailbydomain.com>

Auto manuals search

<http://auto.somanuals.com>

TV manuals search

<http://tv.somanuals.com>