

DE'LONGHI COOKING

**INSTALLATION and SERVICE INSTRUCTIONS
USE and CARE INSTRUCTIONS**

**DEF905E
CERAMIC COOKER**

distributed by
**DeLonghi Australia Pty Ltd
DeLonghi New Zealand Ltd**



Dear Customer,

Thank you for having purchased and given your preference to our product.

The safety precautions and recommendations reported below are for your own safety and that of others. They will also provide a means by which to make full use of the features offered by your appliance.

Please keep this booklet in a safe place. It may be useful in future, either to yourself or to others in the event that doubts should arise relating to its operation.

This appliance must be used only for the task it has explicitly been designed for, that is for cooking foodstuffs. Any other form of usage is to be considered as inappropriate and therefore dangerous.

The manufacturer declines all responsibility in the event of damage caused by improper, incorrect or illogical use of the appliance or by faulty installation.



This appliance has been designed and constructed in accordance with the following codes and specifications:

- AS/NZS 60335.1 General Requirements for Domestic electrical appliances
- AS/NZS 60335.2.6 Particular Requirements for Domestic electrical cooking appliances
- AS/NZS CISPR 14.1 Electromagnetic Compatibility Requirements.

PRODUCT LABEL



Important:

This appliance is designed and manufactured solely for the cooking of domestic (household) food and is not suitable for any non domestic application and therefore should not be used in a commercial environment.

The appliance guarantee will be void if the appliance is used within a non domestic environment i.e. a semi commercial, commercial or communal environment.

FIRST USE OF THE OVEN

It is advised to follow these instructions:

- Furnish the interior of the oven as described at chapters “USE AND CARE” and “CLEANING AND MAINTENANCE”.
- Switch on the empty oven on max to eliminate grease from the heating elements.
- Let the oven cool down and clean the interior of the oven with a cloth soaked in water and neutral detergent, then dry carefully.

IMPORTANT PRECAUTIONS AND RECOMMENDATIONS FOR USE OF ELECTRICAL APPLIANCES

Use of any electrical appliance implies the necessity to follow a series of fundamental rules. In particular:

- Never touch the appliance with wet hands or feet.
- Do not operate the appliance barefooted.
- The appliance is not intended for use by young children or infirm persons without supervision.
- Young children should be supervised to ensure they do not play with the appliance.

The manufacturer cannot be held responsible for any damages caused by improper, incorrect or illogical use of the appliance.

IMPORTANT PRECAUTIONS AND RECOMMENDATIONS

After having unpacked the appliance, check to ensure that it is not damaged and that the oven door closes correctly. In case of doubt, do not use it and consult your supplier or a professionally qualified technician.

Packing elements (i.e. plastic bags, polystyrene foam, nails, packing straps, etc.) should not be left around within easy reach of children, as these may cause serious injuries.

- Some appliances are supplied with a protective film on steel and aluminium parts. This film must be removed before using the appliance.
- Do not attempt to modify the technical characteristics of the appliance as this may become dangerous to use.
- Do not carry out cleaning or maintenance operations on the appliance without having previously disconnected it from the electric power supply.
- After use, ensure that the knobs are in the off position.
- Keep children away from the appliance when it is in use.
- **WARNING:** Accessible parts will become hot when in use. To avoid burns and scalds, young children should be kept away.
- Young children should be supervised to ensure that they do not play with the appliance.
- Children, or persons with a disability which limits their ability to use the appliance, should have a responsible person to instruct them in its use. The instructor should be satisfied that they can use the appliance without danger to themselves or their surroundings.
- During and after use of the appliance, certain parts will become very hot. Do not touch hot parts. Care should be taken to avoid touching heating elements inside the oven.
- Make sure that electrical cables connecting other appliances in the proximity of the cooker cannot come into contact with the hob or become entrapped in the oven door.
- Do not allow heavy or sharp objects to drop on the glass ceramic hob. If the hob is cracked or otherwise damaged by falling objects etc., disconnect the electrical power cord and call Customer Service.

- Do not scratch the hob with sharp objects. Don't use the hob as a work surface.
- **WARNING:** When correctly installed, your product meets all safety requirements laid down for this type of product category. However special care should be taken around the rear or the underneath of the appliance as these areas are not designed or intended to be touched and may contain sharp or rough edges, that may cause injury.
- Do not line the oven walls with aluminium foil. Do not place baking trays or the drip tray on the base of the oven chamber.
- **Fire risk!** Do not store flammable material in the oven or in the storage compartment.
- Always use oven gloves when removing the shelves and food trays from the oven whilst hot.
- Do not hang towels, dishcloths or other items on the appliance or its handle – as this could be a fire hazard.
- Clean the oven regularly and do not allow fat or oils to build up in the oven base or tray. Remove spillages as soon as they occur.
- Do not stand on the open oven door.
- Always stand back from the appliance when opening the oven door to allow steam and hot air to escape before removing the food.
- **Safe food handling:** Leave food in the oven for as short a time as possible before and after cooking. This is to avoid contamination by organisms which may cause food poisoning. Take particular care during warmer weather.
- The manufacturer declines all liability for injury to persons or damage to property caused by incorrect or improper use of the appliance.
- **WARNING: Taking care NOT to lift the oven by the door handle.**
- **IMPORTANT NOTE: This appliance shall not be used as a space heater, especially if installed in marine craft or caravans.**
- **Do not operate your appliance by means of an external timer or separate remote-control system.**
- **This appliance is for domestic use only.**

INSTALLATION

CAUTION:

- This appliance must be installed in accordance with these installation instructions.
- This appliance shall only be serviced by authorised personnel.
- This appliance is to be installed only by an authorised person in compliance with the current electrical regulations and in observation of the instructions supplied by the manufacturer.
Failure to comply with this condition will render the guarantee invalid.
- Incorrect installation, for which the manufacturer accepts no responsibility, may cause personal injury or damage.
- Always disconnect the appliance from mains power supply before carrying out any maintenance operations or repairs.

LOCATION

- The cooker can be installed in a cabinet (Fig. 1).
- The cooker must be installed no less than 50 mm away from any side wall which exceed the height of the cooktop.
- **The appliance must be housed in heat resistant units.**
- **The walls of the units must be capable of resisting temperatures of 75 °C above room temperature.**
- Do not install the appliance near inflammable materials (eg. curtains).
- If you stand the cooker on a pedestal, make sure you provide safety measures to keep it in place.

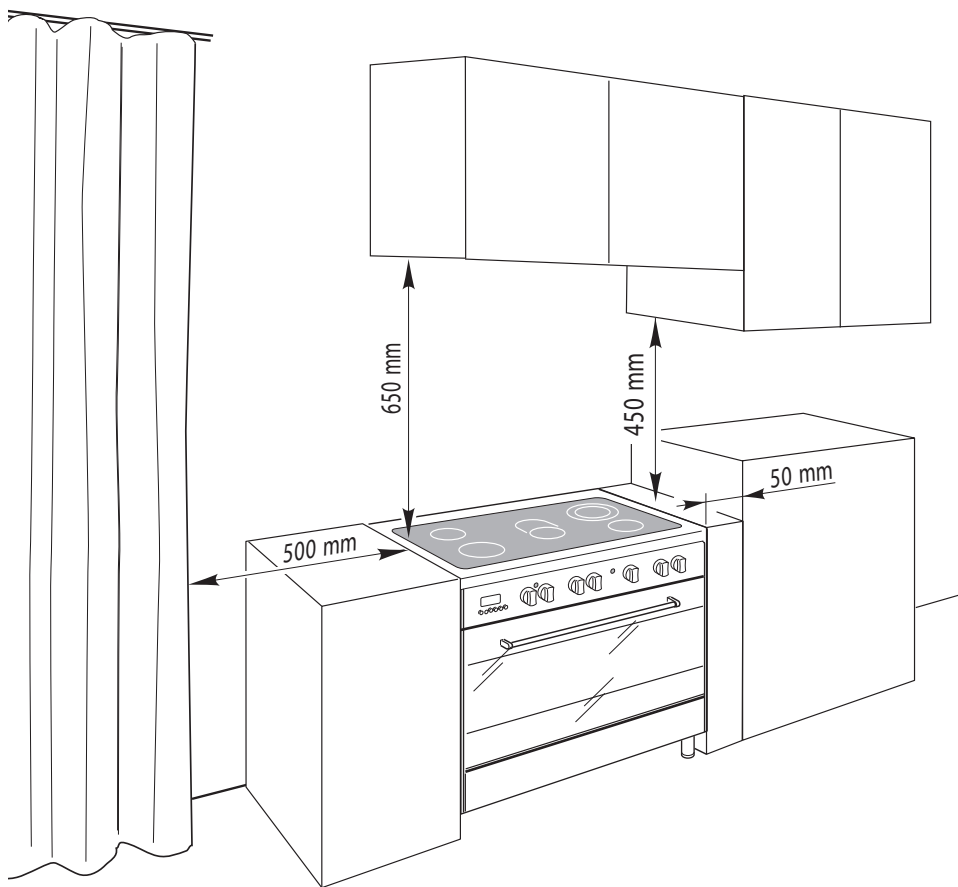

Figure 1

Cooker overall dimensions [mm]

- height: min 900 - max 925
- width: 900
- depth: 600

FITTING THE ADJUSTABLE FEET

The adjustable feet must be fitted to the base of the cooker before use (fig. 2). Rest the rear of the cooker on a piece of the polystyrene packaging exposing the base for the fitting of the feet. Fit the no. 4 (four) legs by screwing them tight into the support base as shown in figure 3.

LEVELLING THE COOKER

The cooker may be levelled by screwing the lower ends of the feet IN or OUT (fig. 4).

Figure 2

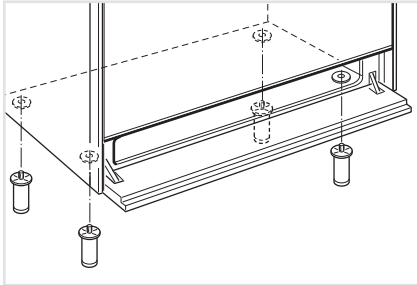

Figure 3

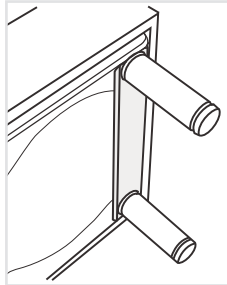
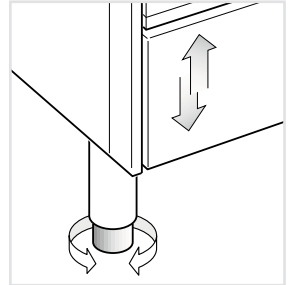

Figure 4



MOVING THE COOKER

WARNING: When raising cooker to upright position always ensure two people carry out this manoeuvre to prevent damage to the adjustable feet (fig. 5).

WARNING - Be careful! Do not lift the cooker by the door handle when raising to the upright position (fig. 6).

WARNING: When moving cooker to its final position DO NOT DRAG (fig. 7). Lift feet clear of floor (fig. 5).

Figure 5

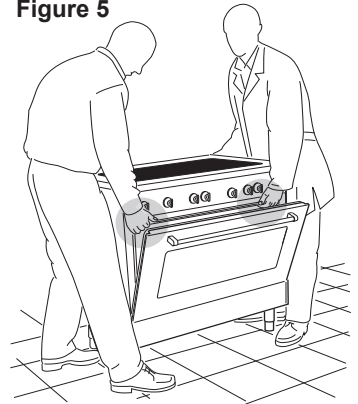

Figure 6

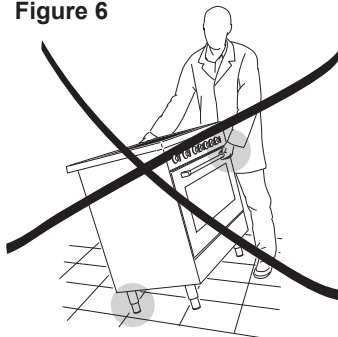
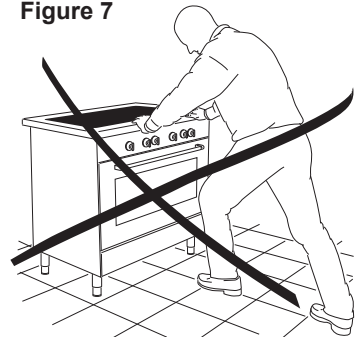

Figure 7



ANTI-TILT BRACKET

Important!

To restrain the appliance and prevent it tipping accidentally, fit a bracket to its rear to fix it securely to the wall. Make sure you also fit the supplied lock pin to the anti-tilt bracket.

To fit the anti-tilt bracket:

1. After you have located where the cooker is to be positioned, mark on the wall the place where the two screws of the anti-tilt bracket have to be fitted. Please follow the indications given in fig. 8.
2. Drill two 8 mm diameter holes in the wall and insert the plastic plugs supplied.

Important!

Before drilling the holes, check that you will not damage any pipes or electrical wires.

3. Loosely attach the anti-tilt bracket with the two screws supplied.
4. Move the cooker to the wall and adjust the height of the anti-tilt bracket so that it can engage in the slot on the cooker's back, as shown in fig. 8.
5. Tighten the screws attaching the anti-tilt bracket.
6. Push the cooker against the wall so that the anti-tilt bracket is fully inserted in the slot on the cooker's back.
7. Access the bracket and fit the lock pin:
 - Open the pivoting panel (fig. 9).
 - Fit the lock pin through the bracket, as shown (fig. 10).
 - Close the pivoting panel.

Figure 8

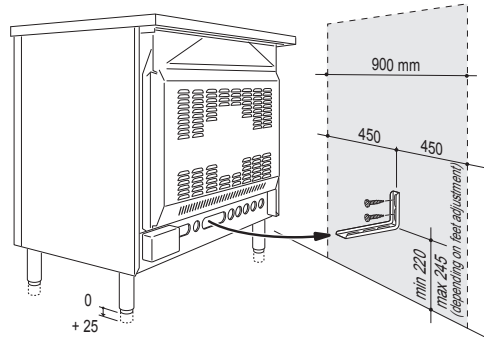

Figure 9

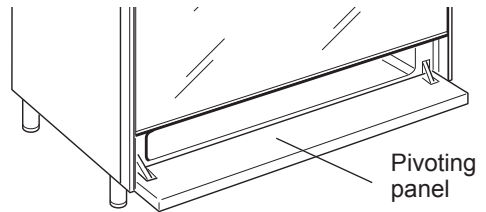
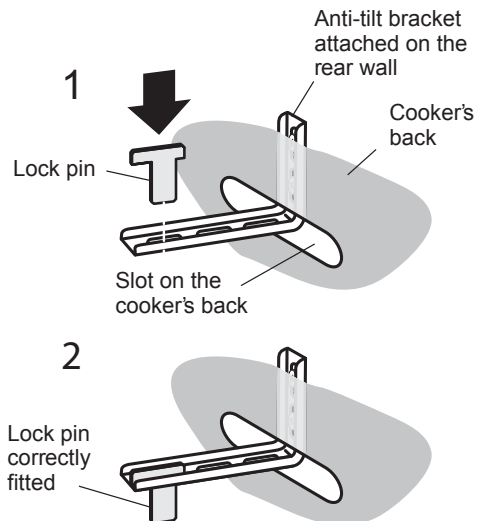

Figure 10



ELECTRICAL REQUIREMENTS

- The appliance must be connected to the mains checking that the voltage corresponds to the value given in the rating plate and that the electrical cable sections can withstand the load specified on the plate.
- A suitable disconnection switch must be incorporated in the permanent wiring, mounted and positioned to comply with the local wiring rules and regulations. The switch must be of an approved type installed in the fixed wiring and provide a 3 mm air gap contact separation in all poles in accordance with the local wiring rules.
In Australia and New Zealand, a switch of the approved type with a 3 mm air gap must be installed in the active (phase) conductor of the fixed wiring.
- The switch must always be accessible.
- The power supply cable must not touch the hot parts and must be positioned so that it does not exceed 75°C above ambient.
- To connect the cooker to the mains electricity supply, do not use adapters, reducers or branching devices as they can cause overheating and burning.
- This cooker must be connected to a suitable double pole control unit adjacent to the cooker. No diversity can be applied to this control unit.
- This cooker must be connected to electrical supply using V105 insulated cable.
In New Zealand, this appliance must be connected to the electrical supply using a cable fitted with an appropriately rated plug. The plug must be compatible with the socket-outlet fitted to the final subcircuit in the fixed wiring that is intended to supply the appliance.
- Once the appliance has been installed, the switch or socket must always be accessible.
- If the supply cord is damaged it must be replaced by the manufacturer or it's Service Agent or a similarly qualified person in order to avoid a hazard.

N.B. The connection of the appliance to earth is mandatory.

If the installation requires alterations to the domestic electrical system call a qualified electrician. He should also check that the domestic electrical system is suitable for the power drawn by the appliance.

Replacing the power cord must be done by a qualified electrician in accordance with the instructions supplied by the manufacturer and in compliance with established electrical regulations.

LOCATING THE AREA FOR ELECTRICAL CONNECTION

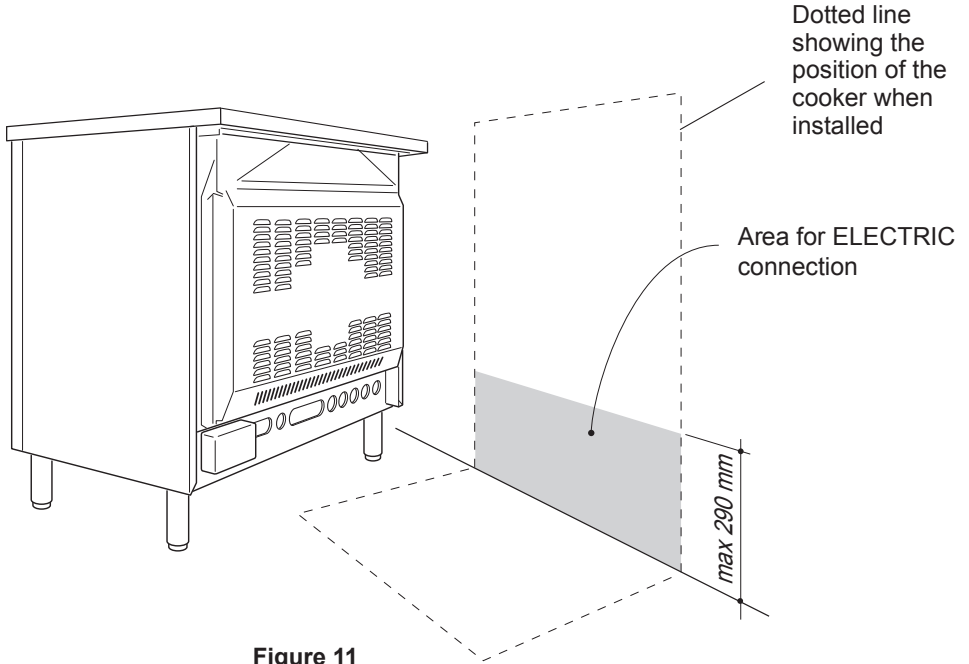

Figure 11

CONNECTION OF THE POWER SUPPLY CABLE

Important! This cooker must be connected to the electricity supply only by an authorised person.

To connect the feeder cable to the cooker it is necessary to:

- Remove the two screws that hold shield “A” behind the cooker (fig. 12).
- Open completely the cable clamp “D”.
- Fitted with a 6-pole terminal block, position the U bolts onto terminal block ‘B’ (fig. 12) according to the diagrams in figs. 13 - 14.
- Feed the supply cable through the cable clamp “D”. The supply cable must be of a suitable size for the current requirements of the appliance; see the section “Feeder cable section”.
- Connect the phase, neutral and earth wires to terminal “B” according to figures 13 and 14.
- Pull the feeder cable and block it with the cable clamp “D”.
- Re-mount shield “A”.

N.B. The earth conductor must be left about 3 cm longer than the others.

VOLTAGE AND POWER CONSUMPTION

230/400 V 3N~ 50 Hz	11800 W (51.30 A) (diversity not applied)
240/415 V 3N~ 50 Hz	12800 W (53.33 A) (diversity not applied)

FEEDER CABLE SECTION

This cooker must be connected to electrical supply using V105 insulated cable.

230 V~, 240 V~	3 x 6 mm ² (*)
230 V 3~, 240 V~	4 x 4 mm ² (*)
400 V 3N~, 415 V 3N~	5 x 2,5 mm ² (*)
400 V 2N~, 415 V 2N~	4 x 4 mm ² (*)

(*) Connection with wall box connection.

- Diversity factor applied.
- A diversity factor may be applied to the total loading of the appliance only by a suitably qualified person.

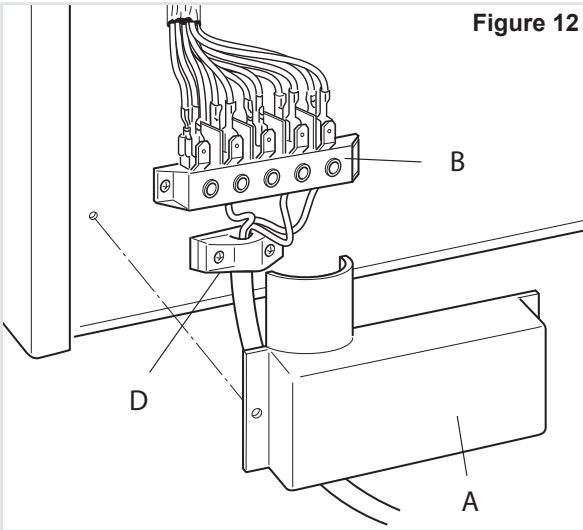
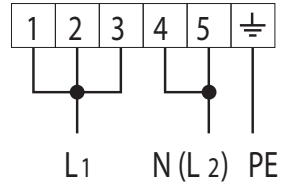

Figure 12

Figure 13

230 V~, 240 V~



230 V 3~, 240 V 3~

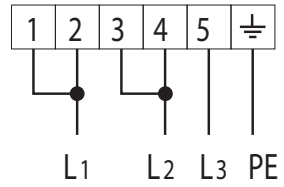

400 V 3N~, 415 V 3N~

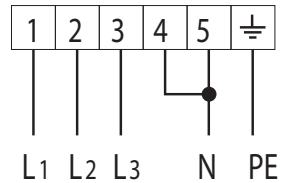

400 V 2N~, 415 V 2N~

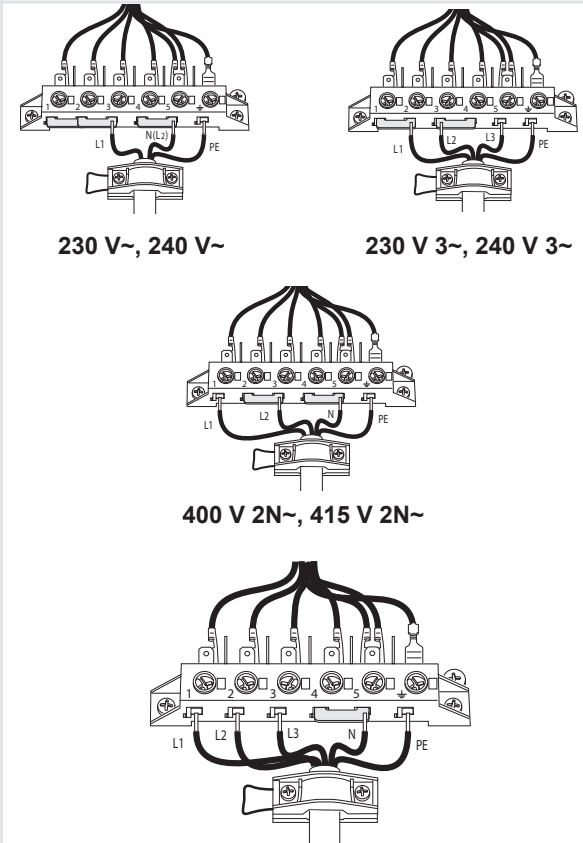
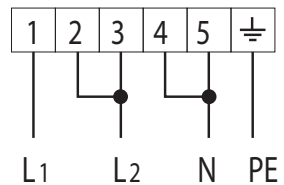

230 V~, 240 V~

230 V 3~, 240 V 3~

400 V 2N~, 415 V 2N~

400 V 3N~, 415 V 3N~

Figure 14

ELECTRIC DIAGRAM

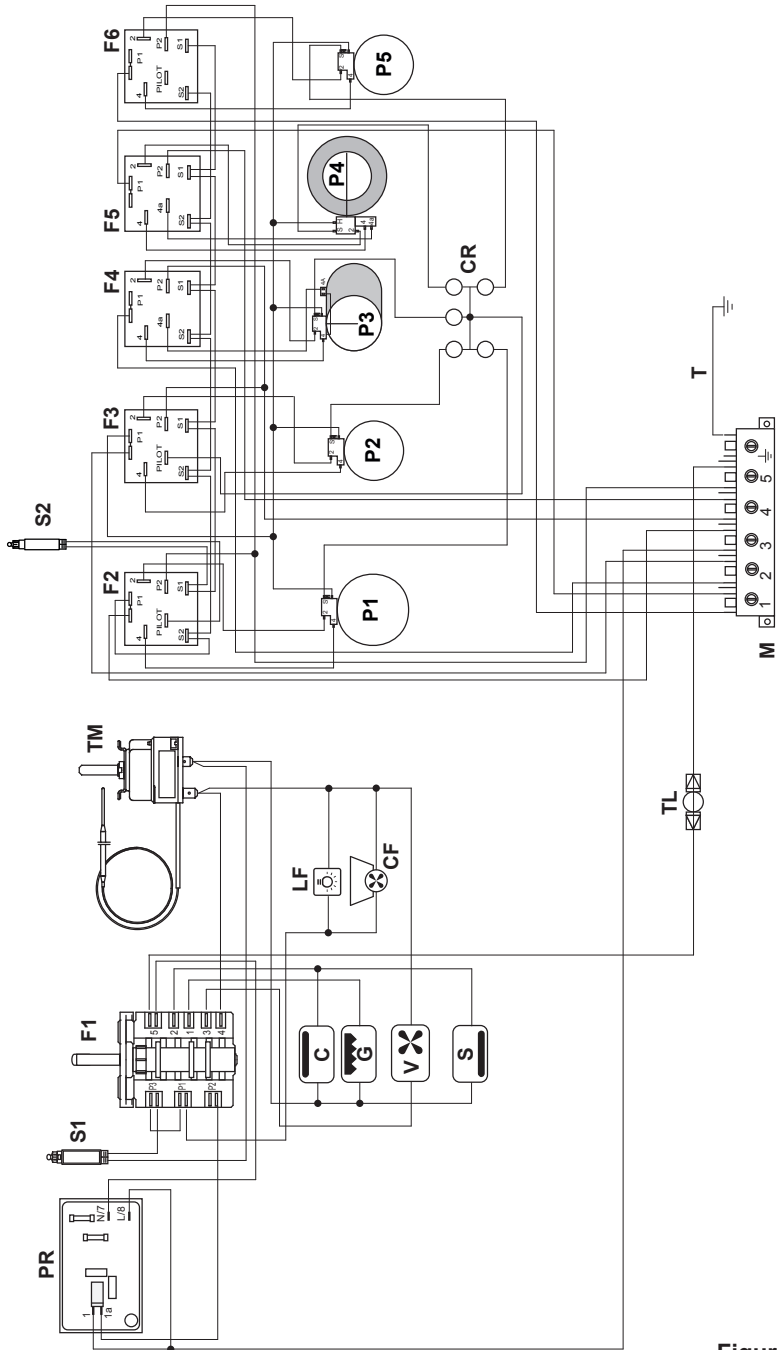

Figure 15

ELECTRIC DIAGRAM KEY

P1/2/5	Hob single zones elements
P3	Hob double zone (oval) element
P4	Hob double zone element
F2/3/6	Energy regulators (single zones)
F4/5	Energy regulators (double zones)
F1	Oven switch
TM	Oven thermostat
LF	Oven lamp
PR	Oven programmer
CF	Cooling fan motor
V	Oven fan motor
C	Oven top element
G	Oven grill element
S	Oven bottom element
TL	Thermal overload
S1	Thermostat pilot lamp
S2	Hob elements pilot lamp
CR	Hob elements residual heat lamps
M	Terminal block
T	Earth connection

USE AND CARE

CAUTION:

- This appliance must be used only for the task it has explicitly been designed for, that is for domestic cooking of foodstuffs. Any other form of usage is to be considered as inappropriate and therefore dangerous.
- Do NOT place combustible materials or products on this appliance at any time.

USING THE OVEN FOR THE FIRST TIME

Operate as follows:

- Slide in the wire racks on the oven walls as in fig. 16.
- Slide in the grease filter on the back of the oven as in fig. 19.
- Slide into the guides, the shelf and the tray (fig. 17).

The rack must be fitted so that the safety notch, which stops it sliding out, faces the inside of the oven; the guard rail shall be at the back.

The oven tray must be correctly placed on its wire shelf support (fig. 18) then inserted into the guides (fig. 17). The oven tray shelf support must be fitted so that the safety notch, which stops it sliding out, faces the inside of the oven



- To eliminate traces of grease in manufacture it is necessary to pre-heat the oven at the maximum temperature:
 - For 60 minutes in the  position and for another 15 minutes in the  position.
- Slide off the wire racks.
- Let the oven cool down, switch off the electrical supply, then clean the inside of the oven with a cloth soaked in water and neutral detergent and dry thoroughly.

Figure 16

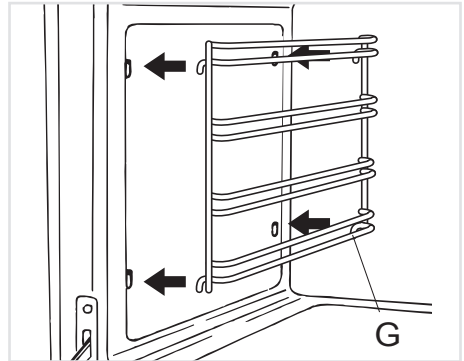

Figure 17

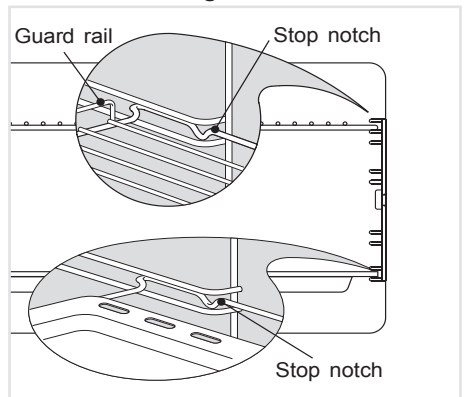
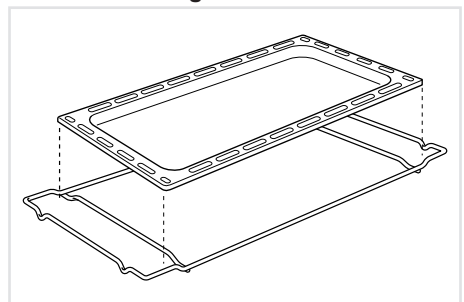

Figure 18



GREASE FILTER

- A special screen is provided at the back of the oven to catch grease particles, mainly when meat is being roasted.
- Clean the filter after any cooking! The grease filter can be removed for cleaning and should be washed regularly in hot soapy water (fig. 19).
- Always dry the filter properly before fitting it back into the oven.

CAUTION: When baking pastry etc. this filter should be removed.

Figure 19

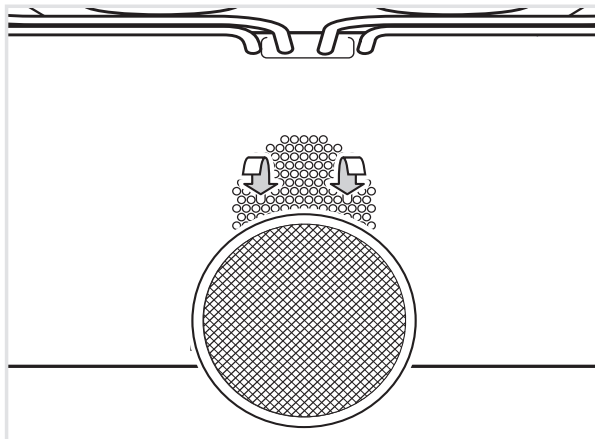

CONTROL PANEL

Figure 20

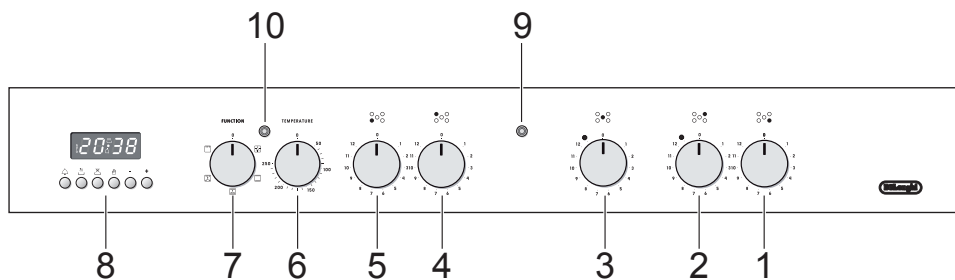

Controls description

1. Front right cooking zone control knob
2. Rear right cooking zone control knob
3. Central cooking zone control knob
4. Rear left cooking zone control knob
5. Front left cooking zone control knob
6. Oven temperature control knob
7. Oven function selector control knob
8. Electronic programmer

Pilot lamps:

9. Cooking zone/s ON indicator light
10. Oven temperature indicator light

Please note:

This appliance incorporates a safety cooling fan which you will hear operating whenever the oven or grill are in use.

This fan is to reduce the external temperature of the appliance and cool the internal components.

VITROCERAMIC HOB

Figure 21

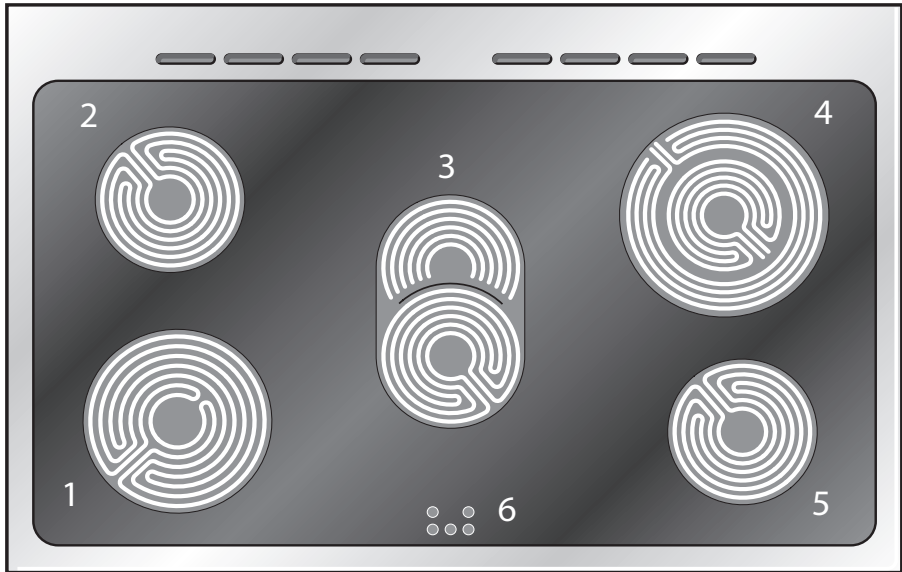

VITROCERAMIC COOKING HOB

- | | | |
|----|---|-------------|
| 1. | “Hi-Light” single zone, Ø 180 mm | 1800 W |
| 2. | “Hi-Light” single zone, Ø 145 mm | 1200 W |
| 3. | “Hi-Light” double zone (oval), Ø 145 x 250 mm | 2000/1100 W |
| 4. | “Hi-Light” double zone, Ø 210/120 mm | 2200/750 W |
| 5. | “Hi-Light” single zone, Ø 145 mm | 1200 W |
| 6. | Cooking zones residual heat indicators | |

Attention:

Detach the appliance from the mains if the ceramic glass is cracked and contact the After-Sales Service.

Metallic objects such as knives, forks, spoons and lids should not be placed on the hob surface since they can get hot.

HOW TO USE THE VITROCERAMIC HOB

The ceramic surface of the hob allows a fast transmission of heat in the vertical direction, from the heating elements underneath the ceramic glass to the pans set on it.

The heat does not spread in a horizontal direction, so that the glass stays “cool” at only a few centimeters from the cooking plate.

The cooking zones are shown by painted disks on the ceramic surface.

Before switching on the cooktop make sure that it is clean.

Important note:

The heating elements incorporate a thermolimiter that switches the element ON/OFF during all settings to protect the ceramic glass from overheating.

The use of incorrect pans and/or wrong pan positioning will cause the temperature limiter to operate more frequently, resulting in a reduction of cooking performance.

The temperature limiter can be seen under the glass dissecting the element. This is not a fault with the appliance.

“HI-LIGHT” SINGLE ZONES (fig. 23)

- The heating element is formed of a coil of resistant material which reaches the working temperature quickly.
- These zones are controlled by a continuous energy regulator switch (fig. 22). The heat intensity can be regulated continuously from “0” to “12” (max).
- Check that the hob is clean and then switch on by turning the control knob.
- When the hob is working, the power on indicator light will be on.

Figure 22

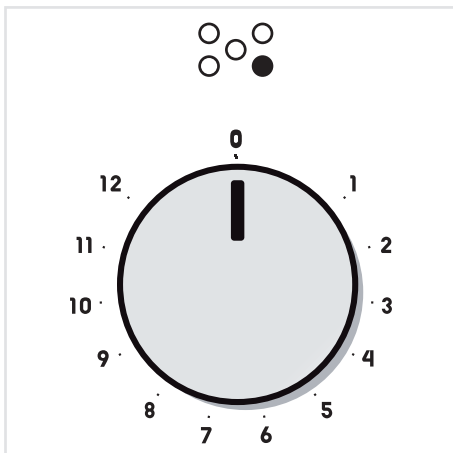
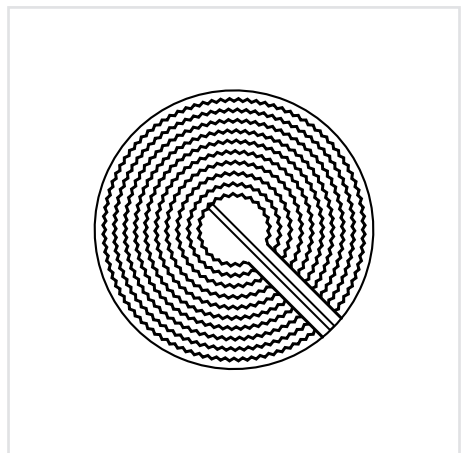



Figure 23



“HI-LIGHT” DOUBLE ZONES (figs. 25, 26)

- The heating element is formed of 2 coils of resistant material which reaches the working temperature quickly.
- This zone is controlled by a continuous energy regulator switch (fig. 24). The heat intensity can be regulated continuously from “0” to “12” (max).
- Check that the hob is clean and then switch on by turning the control knob.
- When the hob is working, the power on indicator light will be on.
- To turn on both zones of the double element, turn the double element knob fully clockwise to the position .
- To reduce the heat of the full double element, turn its knob anticlockwise to setting “12” or lower. Adjust the heat during cooking as necessary.

Note: if you leave the knob at the  position, the full double element will remain at the highest heat setting.

- To return to using only the inner zone of the double element, first turn the knob to the “0” (off) position (you should feel a click) and then clockwise to a setting from “1” to “12”.

Figure 24

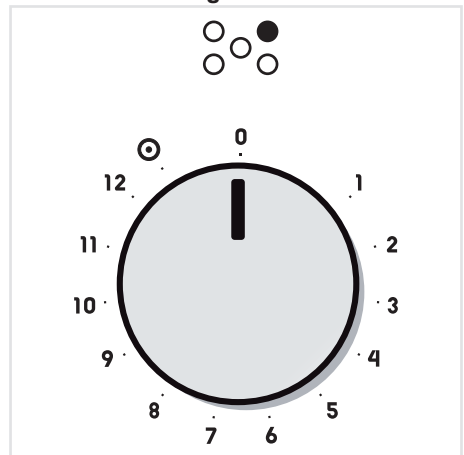

Figure 25

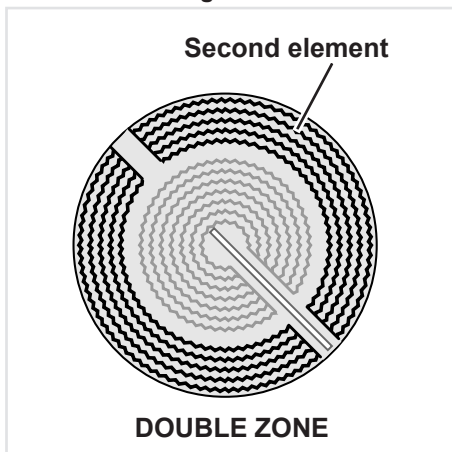
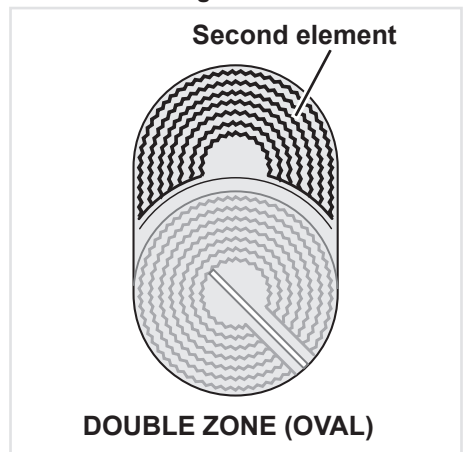

Figure 26



SAFETY HINTS

1. Never put cooking foil or plastic materials on the ceramic surface when the hob is hot.
2. Make sure that the hob is clean before you use it.
3. Always ensure that the base of your saucepan is clean and dry before placing on the hob.
4. The glass-ceramic surface and pans must be clean. Carefully eliminate any food remains (especially containing sugar), dirt etc. with the aid of a cleansing agent.
5. Remember that the plates will remain hot for approximately half an hour after the plate has been switched off.
6. Before you switch the hob on, make sure that you know which knob controls the required hot plate. We advise you to set the pan over the cooking plate before switching it on.
7. Pan handles should never stand out beyond the kitchen worktop, as there is a great danger of knocking the pan over. This will also ensure that children cannot reach them.
8. Do not use pots and pans with rough bases (pay attention to cookware made of cast-iron). Rough bases can damage the glass surface of the hob (scratches).
9. Pots with aluminium bottoms may leave silver streaks or spots on the hob.
10. **DO NOT use the hob if the glass surface is broken or cracked in any way. Please disconnect the appliance from the mains and call the After-Sales Service.**
11. Do not lean over the cooking plate when in use.
12. Do not leave wet or damp lids on the hob.
13. Follow the cleaning instructions carefully.
14. Never use the glass surface for storage.

WARNING:

- **HOB'S BECOME VERY HOT WITH USE, AND RETAIN THEIR HEAT FOR A LONG TIME AFTER COOKING HAS FINISHED. CHILDREN SHOULD BE SUPERVISED AT ALL TIMES AND BE PREVENTED FROM TOUCHING THE HOT SURFACES UNTIL SUCH TIME AS THE APPLIANCE HAS COOLED.**

Figure 27

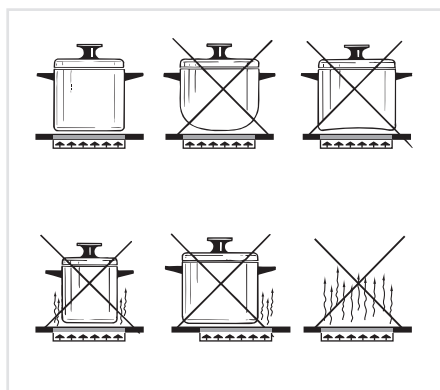
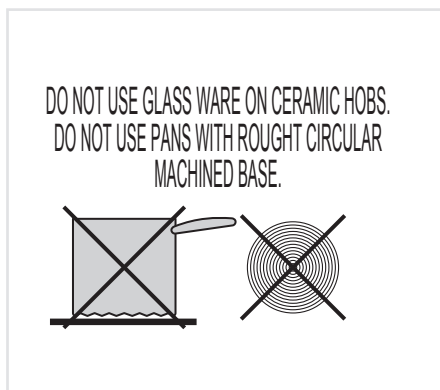

Figure 28



RESIDUAL HEAT INDICATORS

The hob also features no. 6 (six) warning lights which are connected to the corresponding plates.

When the temperature of a cooking plate is above 60°C, the relevant warning light will also light up to warn of heat on the surface of the hob.

This light also stay on after the cooking plate has been switched off to show that the hob surface is still hot.

This residual heat will lasts for a long time after the cooking plate has been switched off.

During this time you should avoid touching the hob surface over the cooking area.

Please pay special attention to ensure that children are not allowed near the hob.

The light will switch off automatically as soon as the surface temperature of the cooking plate falls below 60°C.

Figure 29

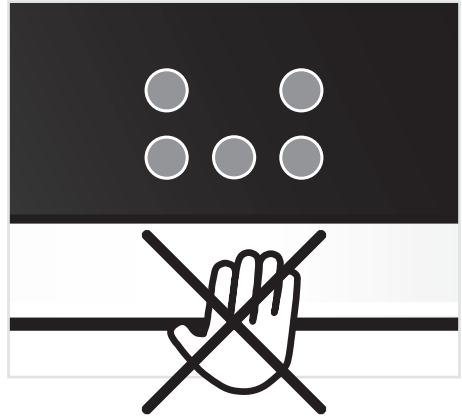

Caution!

**The cooking hob becomes very hot during operation.
Keep children well out of reach.**

COOKING HINTS

- To reduce the cooking time, you can turn the control knob to the max when you switch the plate on.
After a short time you will set the control knob to the required position for the cooking.
- You should use pots and pans with flat bases (pans with the test mark for glass ceramic hobs are available from specialist shops).
The diameter of the pan should match that of the cooking plate (or be slightly bigger) to make the most of the energy.
- Since the cooking surface stays hot for a certain time after the plate has been switched off, you can switch it off 5 or 10 minutes before the end of the cooking.
The residual heat of the hob will complete the cooking.
- To save electricity, use pan lids whenever possible.
- **Never cook the food directly on the glass ceramic cooktop, but in special pans or containers.**
- **Do not scratch the cooktop with cutting or sharp objects. Do not use the glass ceramic surface as a work surface.**

Figure 30

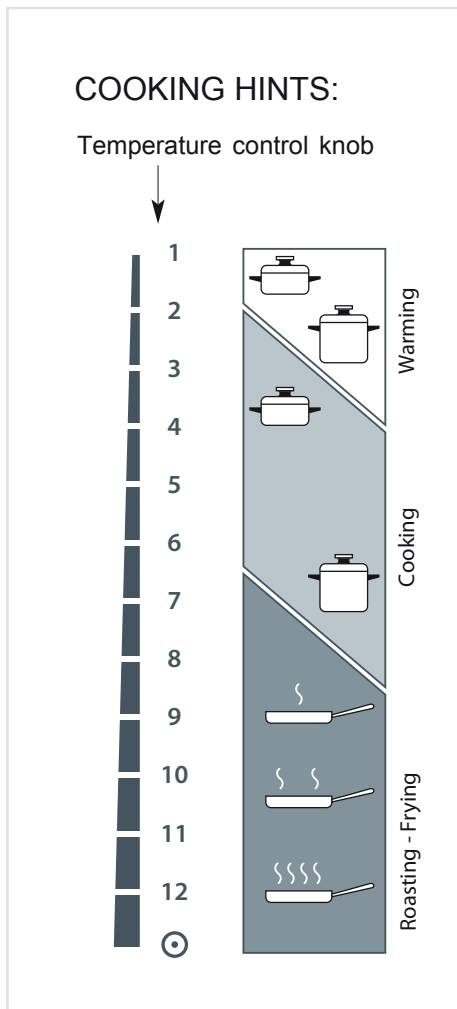

Elements usage table

Knob setting	TYPE OF COOKING
0	Switched OFF
1 2	For melting operations (butter, chocolate).
2 3 4	To maintain food hot and to heat small quantities of liquid (sauces, eggs).
4 5 6	To heat bigger quantities; to whip creams and sauces (vegetables, fruits, soups).
6 7	Slow boiling, i.e.: boiled meats, spaghetti, soups, continuations of steam cooking of roasts, stews, potatoes.
7 8	For every kind of frying, cutlets, uncovered cooking, i.e.: risotto.
8 9 10	Browning of meats, roasted potatoes, fried fish, omelettes, and for boiling large quantities of water.
11 12	Fast frying, grilled steaks, etc.
⊙	Switching on the second element (double zones only)

- Please note that these are only guidelines, you will quickly learn from experience which setting is correct for your needs.

ECONOMIC COOKING

- The ceramic glass retains heat, so you may find that you can switch off the heat 5 minutes before you finish cooking.
- To reduce the cooking time, the plate can be set to the maximum setting at the beginning. It can then be reduced later.

COOKWARE:

It is very important that the pans used on the hobs are made of a suitable material and have the correct base as follows:

- The base should be flat and smooth.
- Any rough part on the pan base could scratch the hob surface.
- Choose pans which are the same size as the hotplates and with bases that are as non reflective as possible. eg. dull and dark.

Only pans recommended for use on ceramic hobs should be used.

Pans made of the following materials can cause problems:

- | | |
|------------------------|---|
| Cast Iron | ■ The base may be rough which will scratch the hob. |
| Toughened Glass | ■ If the pans become too hot, the hob may overheat causing the safety cut out to operate too frequently thus reducing the cooking efficiency. |
| Copper | ■ Can easily distort and will therefore not form a good contact between base and hob which will result in uneven cooking. |

COOKING WITH FAN ASSISTED OVEN

Attention: The oven door becomes very hot during operation. Keep children away.

GENERAL FEATURES

As its name indicates, this is an oven that presents particular features from an operational point of view.

In fact, it is possible to insert 4 different programs to satisfy every cooking need.

The 4 positions, thermostatically controlled, are obtained by 4 heating elements which are:

- Bottom element 2050 W
- Top element 1250 W
- Grill element 2200 W

OPERATING PRINCIPLES

Heating and cooking in the fan assisted oven are obtained in the following ways:

- a. **by normal convection**
The heat is produced by the upper and lower heating elements.
- b. **by semi-forced convection**
The heat produced by the upper and lower heating elements is distributed throughout the oven by the fan.
- c. **by radiation**
The heat is irradiated by the infra red grill element.
- d. **by radiation and ventilation**
The irradiated heat from the infra red grill element is distributed throughout the oven by the fan.
- e. **by ventilation**
The food is defrosted by using the fan only function without heat.

WARNING:

The door is hot, use the handle.

During use the appliance becomes hot. Care should be taken to avoid touching heating elements inside the oven.

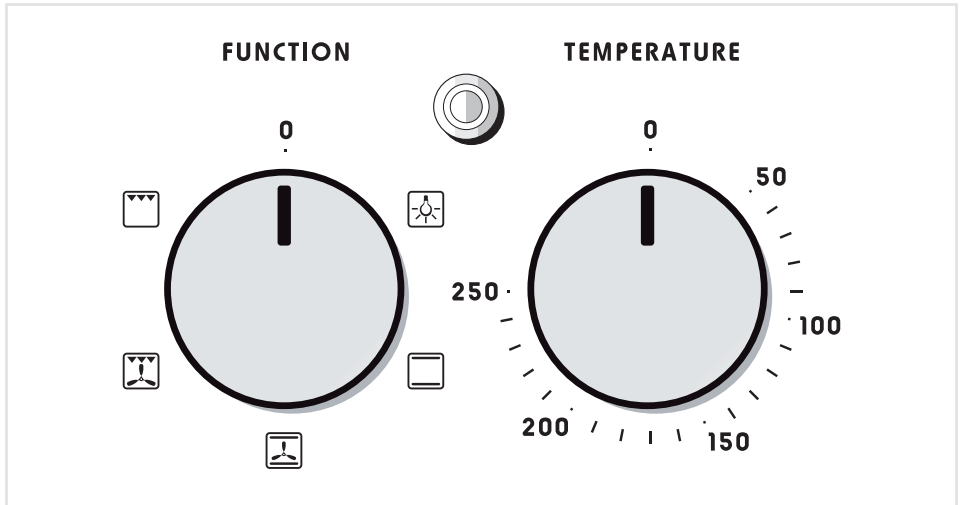

Figure 31

THERMOSTAT KNOB

To turn on the heating elements of the oven, set function selector knob to the required position and the thermostat knob to the desired temperature.

To set the temperature, turn the thermostat control knob indicator mark to the required temperature.

The elements will turn on or off automatically which is determined by the thermostat. The operation of the heating elements is signalled by a light placed above the knob.

FUNCTION SELECTOR KNOB

Rotate the knob clockwise to set the oven for one of the following functions:



OVEN LIGHT

By turning the knob onto this setting we light the oven cavity. The oven remains alight while any of the functions is on.



TRADITIONAL CONVECTION COOKING

The upper and lower heating elements are switched on. The heat is diffused by natural convection and the temperature must be regulated between 50°C and the maximum position with the thermostat knob.

It is necessary to preheat the oven before introducing the foods to be cooked.

Recommended for:

For foods which require the same cooking temperature both internally and externally, i. e. roasts, spare ribs, meringue, etc.



CONVECTION COOKING WITH VENTILATION

The upper and lower heating elements and the fan turn on. The heat coming from the top and bottom is diffused by forced convection. The temperature must be regulated between 50°C and the maximum position with the thermostat knob.

Recommended for:

For foods of large volume and quantity which require the same internal and external degree of cooking; for ie: rolled roasts, turkey, legs, cakes, etc.



DEFROST

With the thermostat knob on “0” only the oven fan is on. The food is thawed by ventilation without heating.

Recommended for:

Quick thawing of frozen foods; one kg requires approximately 1 hour. Thawing times vary according to the quantity and type of food to be thawed.



VENTILATED GRILL COOKING

The infra-red grill and the fan are on. The heat is mainly diffused by radiation and the fan then distributes it throughout the oven.

Use with the oven door closed and the thermostat knob must be regulated **between 50°C and 200°C maximum.**

It is necessary to preheat the oven for about 5 minutes.

For correct use see chapter “GRILLING AND AU GRATIN”.

Always grill with the oven door closed.

Recommended for:

For grill cooking when a fast outside browning is necessary to keep the juices in, i. e. veal steak, steak, hamburger, etc.



GRILLING

The infra-red heating element is switched on.

The heat is diffused by radiation.

Use with the oven door closed and the thermostat knob to **position 225 °C for max 15 minutes, then to position 175 °C.**

For correct use see chapter “USE OF THE GRILL”.

Always grill with the oven door closed.

Recommended for:

Intense grilling, browning, cooking au gratin and toasting etc.

COOKING ADVICE

**The external parts of the appliance become hot during operation.
Keep children well out of reach.**

OVEN COOKING

To cook, before introducing the food, preheat the oven to the desired temperature. When the oven has reached the desired temperature, introduce the food, control the cooking time and turn off the oven 5 minutes before the theoretical time to recuperate the stored heat.

STERILIZATION

Sterilization of foods to be conserved, in full and hermetically sealed jars, is done in the following way:

- Set the switch to position .
- Set the thermostat knob to position 175 °C and preheat the oven.
- Fill the dripping pan with hot water.
- Set the jars onto the dripping pan making sure they do not touch each other and the door and set the thermostat knob to position 130 °C.

When sterilization has begun, that is, when the contents of the jars start to bubble, turn off the oven and let cool.

REGENERATION

Set the switch to position  and the thermostat knob to position 150° C.

Bread becomes fragrant again if wet with a few drops of water and put into the oven for about 10 minutes at the highest temperature.

ROASTING

To obtain classical roasting, it is necessary to remember:

- that it is advisable to maintain a temperature between 180 and 200 °C.
- that the cooking time depends on the quantity and the type of foods.

COOKING DIFFERENT DISHES AT THE SAME TIME

The fan assisted oven set on position  gives simultaneous heterogeneous cooking of different foods.

Different foods such as fish, cake and meat can be cooked together without mixing the smells and flavours.

This is possible since the fats and vapors are oxidized while passing through the electrical element and therefore are not deposited onto the foods.

The only precautions to follow are:

- The cooking temperatures of the different foods must be as close to as possible, with a maximum difference of 20° - 25 °C.
- The introduction of the different dishes in the oven must be done at different times in relation to the cooking times of each one.

The time and energy saved with this type of cooking is obvious.

USE OF THE GRILL

Preheat the oven for about 5 minutes.

Introduce the food to be cooked, positioning the rack as close to the grill as possible. The dripping pan should be placed under the rack to catch the cooking juices and fats.

Grilling with the oven door closed.

Do not grill for longer than 30 minutes at any one time.

ATTENTION: the oven door becomes very hot during operation. Keep children away.

GRILLING AND “AU GRATIN”

Grilling may be done using the grill+fan setting , in this setting the hot air completely surrounds the food that is to be cooked, to give a more even and rapid cooking process.

Set the temperature knob **between 50°C and 200°C maximum**, preheat the oven, then simply place the food on the grid.

Close the door until grilling is complete.

Adding a few dabs of butter before the end of the cooking time gives the golden “au gratin” effect.

Grilling with the oven door closed.

Do not grill for longer than 30 minutes at any one time.

ATTENTION: the oven door becomes very hot during operation. Keep children away.

RECOMMENDED COOKING TEMPERATURE

Food	°C	°F	Gas Mark	Shelf Position*	Cooking Time (approx)
CAKES					
Victoria sandwich	190	375	5	2 or 3	20-25 mins
Small cakes/buns	190	375	5	1 and 2	15-20 mins
Maidera cake	180	350	4	2 or 3	20 mins
Fruit cake	170	325	3	3	1 ^{3/4} hours
Rich fruit cake	150	300	2	3 or 4	2 ^{1/2} hours
Scones	225	425	8 - 9	2	8-10 mins
PASTRY					
Puff	225	425	8 - 9	2	10-20 mins
Short crust	200	400	6	2	20-30 mins
Plate tarts	200 - 210	400 - 410	6	1 or 2	30-35 mins
Quiches and flans	200 - 210	400 - 410	6	1 or 2	40-45 mins
YEAST					
Bread loaf	225	425	7 - 8	2	35-55 mins
Bread rolls	220	425	7	1 or 2	15-20 mins
Pizza dough	230	450	8	2	20 mins
ROAST MEAT					
Beef – Medium	190	375	5	2 or 3	20 mins/lb + 20 mins
Lamb	190	375	5	2 or 3	25-30 mins/b + 25 mins
Pork	190 - 200	375 - 400	5 - 7	2 or 3	30 mins/lb + 30 mins
Veal	190	375	5	2 or 3	30 mins/b + 30 mins
Chicken	190	375	5	2 or 3	30 mins/b + 30 mins
Turkey up to 10lb	180	350	4	2 or 3	18-20 mins/b + 20 mins
Stews/casseroles	150 - 170	300 - 325	2 - 3	2 or 3	1 ^{1/2} 2 hours

N.B. For fan ovens reduce the temperature by 10-20°C. For any dish taking one hour or over to cook, reduce the cooking time by 10 minutes per hour.







* Shelf positions have been counted from the top of the oven to the base. A fan oven creates more even temperature throughout, therefore the shelf positions are not as critical.

DIGITAL ELECTRONIC PROGRAMMER

The electronic programmer is a device which groups together the following functions:

- 24 hours clock with illuminated display.
- Timer (up to 23 hours and 59 minutes).
- Program for automatic oven cooking.
- Program for semi-automatic oven cooking.

Description of the buttons:

-  Timer
-  Cooking time
-  End of cooking time
-  Manual position and cancellation of the inserted cooking programme
-  To increase the numbers on the digital display
-  To decrease the numbers on the digital display and changing the frequency of the audible signal

Description of the illuminated symbols:

AUTO - *flashing* - Programmer in automatic position but not programmed



AUTO - *illuminated* - Programmer in automatic position with program inserted.

 Automatic cooking taking place

 Timer in operation

 and **AUTO** - *flashing* - Program error.
(The time of day lies between the calculated cooking start and end time).

Note:

Select a function by the respective button and, in 5 seconds, set the required time with the  /  buttons ("one-hand" operation).

After a power cut the display resets to zero and cancels the set programs.

Figure 32





Figure 33







ELECTRONIC CLOCK (fig. 33)

The programmer is equipped with an electronic clock with illuminated numbers which indicates hours and minutes.



Upon immediate connection of the oven or after a power cut, three zeros will flash on the programmer display.

To set the correct time of day it is necessary to push the  button and then the  or  button until you have set the correct time (fig. 29).

In another way push simultaneously the   two buttons and at the same time push the  or  button.

Note: If the clock is reset it deletes any previously set programs

NORMAL COOKING WITHOUT THE USE OF THE PROGRAMMER

To manually use the oven, without the aid of the programmer, it is necessary to cancel the flashing **AUTO** by pushing the  button (**AUTO** will be switched off and the symbol  will illuminate - Fig. 34).

Attention: If the **AUTO** is illuminated (which means a cooking program has already been inserted), by pushing the button  you cancel the program and return to manual operation.

If the oven is switched on, you must switch off manually.

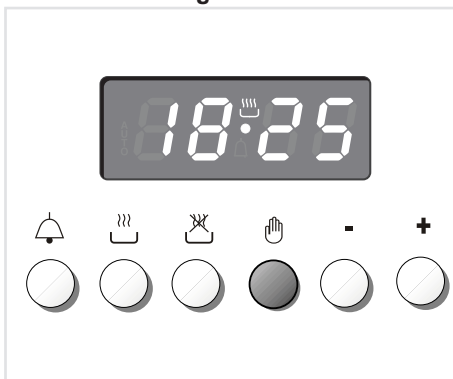

Figure 34





ELECTRONIC TIMER



The timer program consists only of a buzzer which may be set for a maximum period of 23 hours and 59 minutes.

If the **AUTO** symbol is flashing push the  button.

To set the time, push the  button and the  or  until you obtain the desired time in the display (fig. 35).

Having finished the setting, the clock hour will appear on the panel and the  symbol will be illuminated.

The countdown will start immediately and may be seen at any moment on the panel by simply pressing the button .

At the end of the time, the  symbol will disappear and the buzzer will sound and continue for approximately 7 minutes or until a button is pressed (not the  /  buttons). After a short time the display will revert back to the time of day.

SETTING THE FREQUENCY OF THE AUDIBLE SIGNAL

The buzzer has 3 different tones and can be changed by pressing the  button, but only when the time of day is displayed.

Figure 35









AUTOMATIC OVEN COOKING

To cook food automatically in the oven, it is necessary to:

1. Set the length of the cooking period.
2. Set the end of the cooking time.
3. Set the temperature and the oven cooking program.

These operations are done in the following way:

1. Set the length of the cooking period by pushing the  button and the button  to increase, or  to decrease if you have passed the desired time (fig. 36). The **AUTO** and the  symbol will illuminate.
2. Set the end of the cooking time by pressing the  button (the cooking time already added to the clock time will appear), and the  button (fig. 37); if you pass the desired time you may get back by pushing the  button.



After this setting, the  symbol will disappear. If after this setting, the **AUTO** flashes on the display and a buzzer sounds, it means there was an error in the programming, that is that the cooking cycle has been superimposed on the clock. In this case, modify the end of cooking time or the cooking period itself by following again the above mentioned instructions.

Figure 36





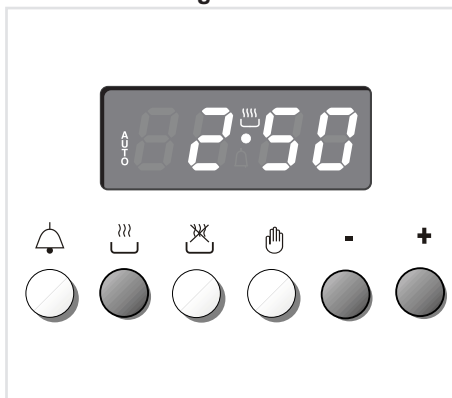

3. Set the temperature and the cooking program by using the switch and thermostat knobs of the oven (see specific chapters).

Now the oven is programmed and everything will work automatically, that is the oven will turn on at the right moment to end the cooking at the established hour. During cooking, the  symbol remains illuminated.

By pushing the  button you can see the time that remains until the end of cooking.

The cooking program may be cancelled at any time by pushing .

At the end of the cooking time the oven will turn off automatically, the  symbol will turn off, **AUTO** will flash and a buzzer will sound, which can be turned off by pushing any of the buttons except the  /  buttons.

Turn the switch and thermostat knobs to zero and put the programmer onto "manual" by pressing the  button.

Attention: After a power cut the clock resets to zero and cancels the set programs. After a power cut, three zeros will flash on the display.



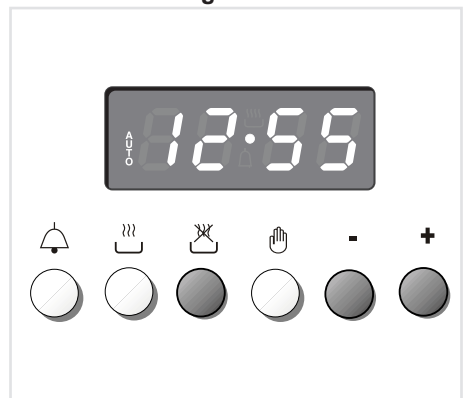



Figure 37



SEMI-AUTOMATIC COOKING

This is used to automatically switch off the oven after the desired cooking time has elapsed.



There are two ways to set your oven:

1. Set the length of the cooking time by pushing the  button and the  button to advance, or  to go backwards if you have passed the desired time (fig. 38).
or
2. Set the end of the cooking time by pushing the  button and the  button to advance, or  to go backwards if you have passed the desired time (fig. 39).



AUTO and the  symbol will be on.

Then set the temperature and the cooking programme using the oven switch and thermostat knobs (see specific chapters).

The oven is switched on and it will be switched off automatically at the end of the desired time.

During cooking, the  symbol remains on and by pressing the button  you can see the time that remains till the end of the cooking.

The cooking program may be cancelled at any time by pushing .

At the end of the cooking time the oven will turn off automatically, the  symbol will turn off, **AUTO** will flash and a buzzer will sound, which can be turned off by pushing any of the buttons except the  /  buttons.

Turn the switch and thermostat knobs to zero and put the programmer onto “manual” by pressing the .

Attention: After a power cut the clock resets to zero and cancels the set programs. After a power cut, three zeros will flash on the display.

Figure 38

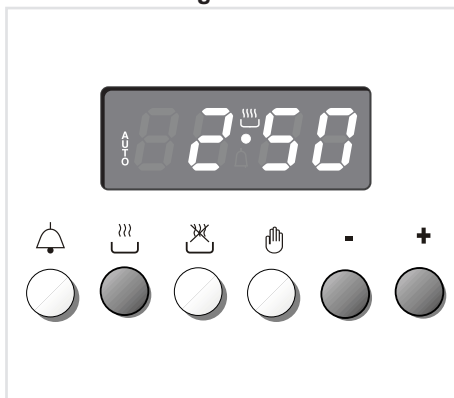
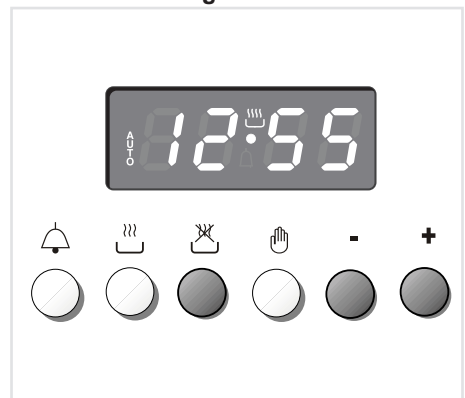

Figure 39



CLEANING AND MAINTENANCE

GENERAL ADVICE

- **Before you begin cleaning, you must ensure that the appliance is switched off and disconnected from the electrical power supply.**
- It is advisable to clean when the appliance is cold and especially when cleaning the enamelled parts.
- Avoid leaving alkaline or acidic substances (lemon juice, vinegar, etc.) on the surfaces.
- Avoid using cleaning products with a chlorine or acidic base.
- **Do not use a steam cleaner because the moisture can get into the appliance thus make it unsafe.**
- **Important: The use of suitable protective clothing/gloves is recommended when handling or cleaning of this appliance.**
- **Do not use harsh abrasive cleaners or sharp metal scrapers to clean the oven door glass since they can scratch the surface, which may result in shattering of the glass.**

WARNING!

When correctly installed, your product meets all safety requirements laid down for this type of product category. However special care should be taken around the rear or the underneath of the appliance as these areas are not designed or intended to be touched and may contain sharp or rough edges, that may cause injury.

ENAMELLED PARTS

All the enamelled parts must be cleaned with a sponge and soapy water or other non-abrasive products.

Dry preferably with a microfibre or soft cloth.

Acidic substances like lemon juice, tomato sauce, vinegar etc. can damage the enamel if left too long.

STAINLESS STEEL, ALUMINIUM PARTS, PAINTED AND SILK-SCREEN PRINTED SURFACES

Clean using an appropriate product.

Always dry thoroughly.

IMPORTANT: these parts must be cleaned very carefully to avoid scratching and abrasion. You are advised to use a soft cloth and neutral soap.

CAUTION: Do not use abrasive substances or non-neutral detergents as these will irreparably damage the surface.

CLEANING THE CERAMIC HOB

- Remove spillages and other types of incrustations.
- Dust or food particles can be removed with a damp cloth.
- If you use a detergent, please make sure that it is not abrasive or scouring. Abrasive or scouring powders can damage the glass surface of the hob.
- All traces of the cleaner must be removed with a damp cloth.
- Dust, fat and liquids from food that has boiled over must be removed as soon as possible.
- If they are allowed to harden they become increasingly difficult to remove.
This is especially true in the case of sugar/syrup mixtures which could permanently pit the surface of the hob if left to burn on it.
- Keep all objects that could be melted by the heat away from the top: plastic objects, aluminium foil, sugar or sugary products.
- If any of these products has melted on the ceramic surface, you should remove it immediately (when the surface is still hot) by using the scraper supplied with the appliance to avoid any permanent damage to the surface of the hob.
- Avoid using a knife or other sharp utensil as these may damage the ceramic surface.
- Do not use steel wool or an abrasive sponge which could scratch the surface permanently.
- **ATTENTION - MOST IMPORTANT!**
If cleaning the glass ceramic hob using a special scraper tool take extra care to avoid damaging the seal at the edges of the glass ceramic surface.

Figure 40

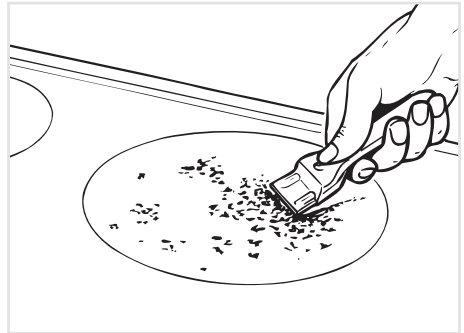

INSIDE OF OVEN

The oven should always be cleaned after use when it has cooled down. The cavity should be cleaned using a mild detergent solution and warm water. Suitable proprietary chemical cleaners may be used after first consulting with the manufacturers recommendations and testing a small sample of the oven cavity. Abrasive cleaning agents or scouring pads/cloths should not be used on the cavity surface.

NOTE: The manufacturers of this appliance will accept no responsibility for damage caused by chemical or abrasive cleaning.



Do not store flammable material in the oven.

Let the oven cool down and pay special attention no to touch the hot heating elements inside the oven cavity.

GRILL HEATING ELEMENT

- The heating element is self-cleaning and does not require maintenance.

GREASE FILTER

Clean the filter after any cooking!

The grease filter can be removed for cleaning and should be washed regularly in hot soapy water (fig. 19 at page 17). Always dry the filter properly before fitting it back into the oven.

OVEN FLOOR

The oven floor "F" (fig. 41) can be easily removed to facilitate cleaning.

Remember to replace the floor correctly afterwards.

Be careful not to confuse the tray "L" with the oven floor "F".

Figure 41

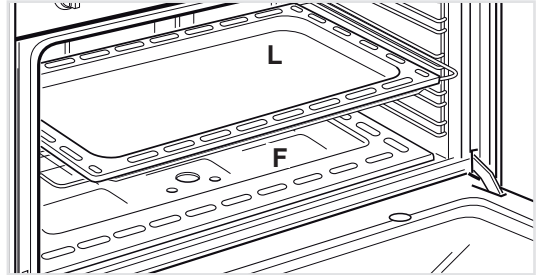

STORAGE COMPARTMENT

The storage compartment is accessible through the pivoting panel (fig. 42).



Do not store flammable material in the storage compartment.

Figure 42

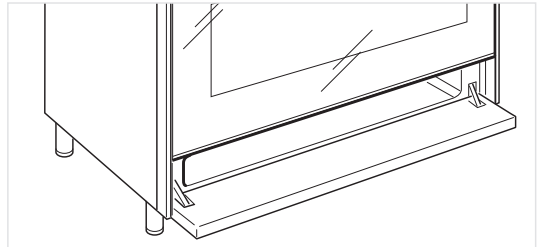

REPLACING THE OVEN LIGHT

WARNING: Ensure the appliance is switched off before replacing the lamp to avoid the possibility of electric shock.

- Let the oven cavity and the heating elements to cool down.
- Switch off the electrical supply.
- Remove the protective cover "A" (fig. 43).
- Replace the lamp "B" with a new one suitable for high temperatures (300°C) having the following specifications 220-240V or 230-240V, 50Hz, type E14 and same power (check watt power as stamped in the bulb itself) of the replaced lamp.
- Refit the protective cover "A".

NOTE: Oven bulb replacement is not covered by your guarantee.

Figure 43

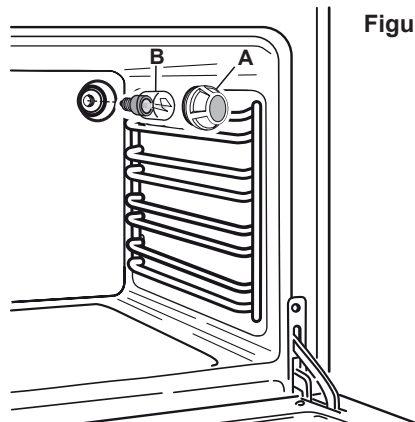

REMOVING AND REPLACING THE INNER DOOR GLASS PANE FOR CLEANING

If you wish to clean the inner glass of the door, make sure you follow the precautions and instructions very carefully.

Replacing the glass pane and the door incorrectly may result in damage to the appliance and may void your warranty.

IMPORTANT!

- Take care, the oven door is heavy. If you have any doubts, do not attempt to remove the door.
 - Make sure the oven and all its parts have cooled down. Do not attempt to handle the parts of a hot oven.
 - The internal glass panel can be easily removed for cleaning by unscrewing the 4 retaining screws (fig. 44).
 - Take extreme care when handling the glass pane. Avoid the edges of the glass bumping against any surface. This may result in the glass shattering.
 - **CAUTION:**
Do not use harsh abrasive cleaners or sharp metal scrapers to clean the oven door glass since they can scratch the surface, which may result in shattering of the glass.
 - If you notice any sign of damage on any of the glass panes (such as chipping, or cracks), do not use the oven. Call your Authorised Service Centre or Customer Care.
 - Make sure you replace the glass pane correctly. Do not use the oven without glass pane correctly in place.
 - If the glass pane feels difficult to remove or replace, do not force it. Call your Authorised Repairer or Customer Care for help.
- Note:** service visits providing assistance with using or maintaining the oven are not covered by your warranty.

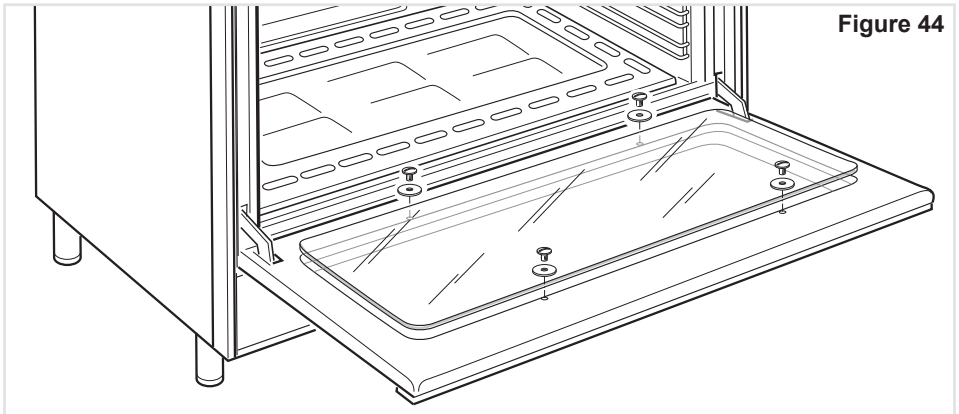

REMOVING THE OVEN DOOR

The oven door can easily be removed as follows:

- Open the door to the full extent (fig. 45a).
- Attach the retaining rings to the hooks on the left and right hinges (fig. 45b).
- Hold the door as shown in fig. 45c.
- Gently close the door and withdraw the lower hinge pins from their location (fig. 45d).
- Withdraw the upper hinge pins from their location (fig. 45e).
- Rest the door on a soft surface.
- To replace the door, repeat the above steps in reverse order.

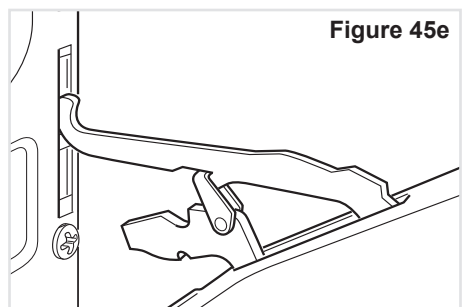
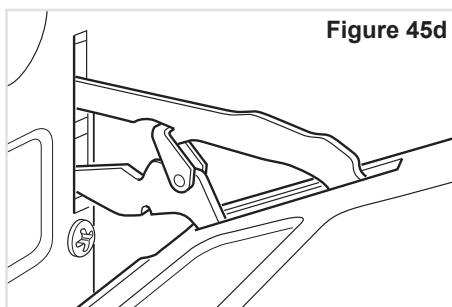
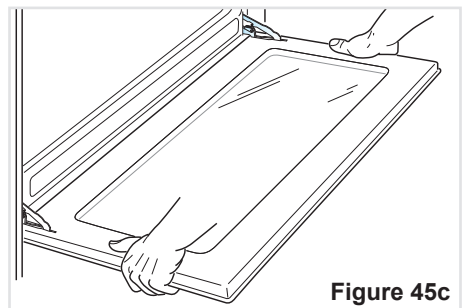
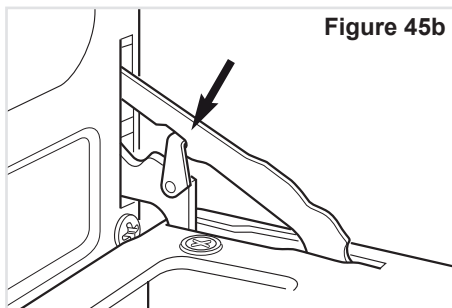
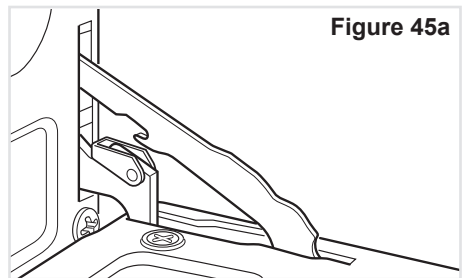

SERVICE AND MAINTENANCE

SERVICING THE APPLIANCE

Service may be obtained by contacting our Customer Service Centre to locate the nearest Authorised Delonghi Service Agent:

Servicing shall be carried out only by authorized personnel.

The appliance shall not be modified.

TROUBLESHOOTING

If you experience a problem with your oven, check the following points before calling our Customer Service Centre for assistance.

1. The power is switched on.
2. The controls are switched on.
3. Oven only: you have set the clock of the electronic programmer (the oven will not work until this has been done).
4. Oven only: none semi-automatic or automatic cooking program has been selected.
5. Both the fuse and the mains fuse are intact.

Should you still require assistance please contact our Customer Service Centre for your nearest Authorised Delonghi Service Agent.

Descriptions and illustrations in this booklet are given as simply indicative.
The manufacturer reserves the right, considering the characteristics of the models described here, at any time and without notice, to make eventual necessary modifications for their construction or for commercial needs.

www.delonghi.com.au
www.delonghi.co.nz

Cod. 1104176 - B1



Free Manuals Download Website

<http://myh66.com>

<http://usermanuals.us>

<http://www.somanuals.com>

<http://www.4manuals.cc>

<http://www.manual-lib.com>

<http://www.404manual.com>

<http://www.luxmanual.com>

<http://aubethermostatmanual.com>

Golf course search by state

<http://golfingnear.com>

Email search by domain

<http://emailbydomain.com>

Auto manuals search

<http://auto.somanuals.com>

TV manuals search

<http://tv.somanuals.com>