

IMPORTA EGUARDS

**DeLonghi**

---

# AUTOMATIC CORDLESS KETTLE

## BUILLOIRE



INSTRUCTION FOR USE

MODE D'EMPLOI

---

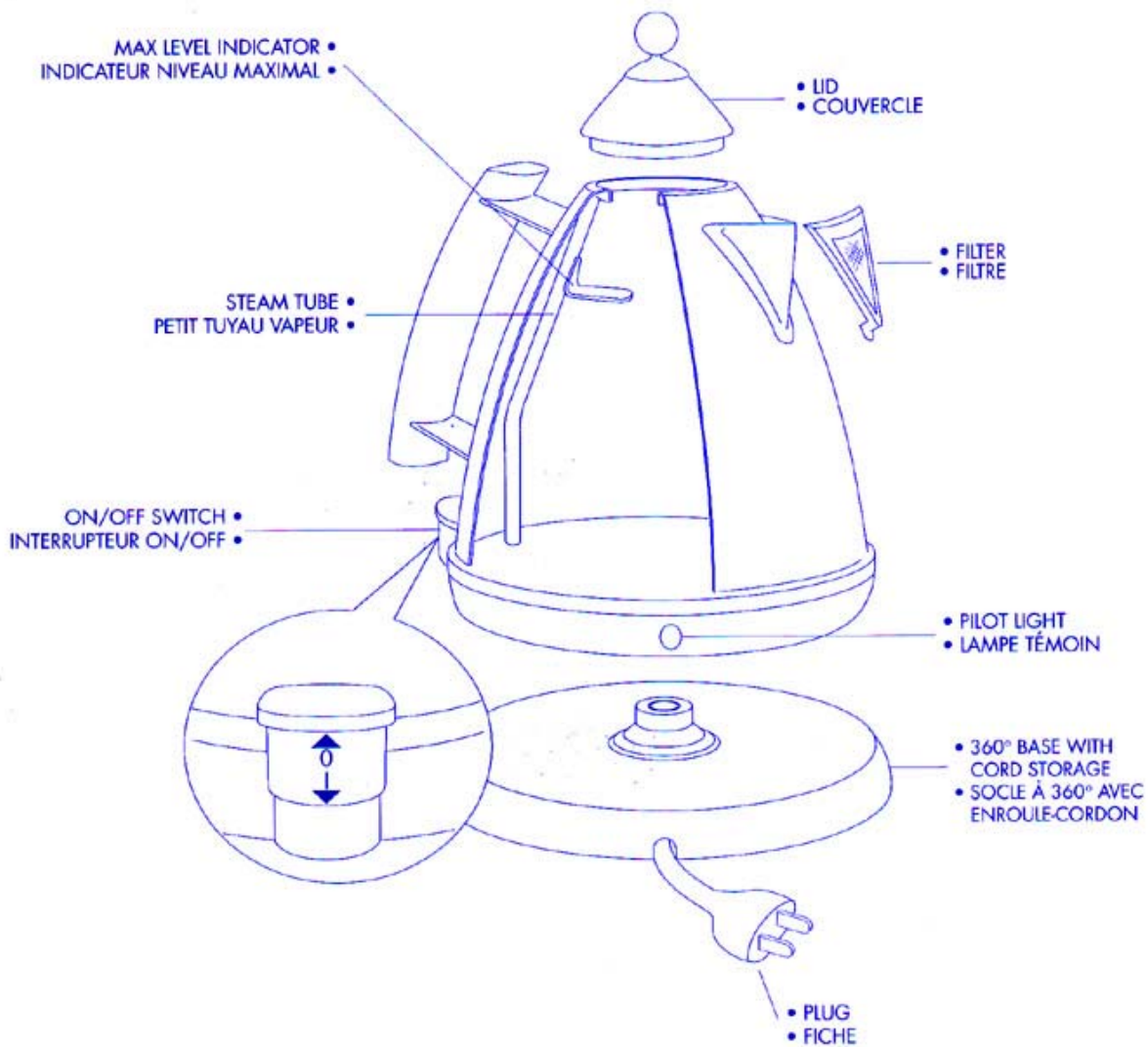



# IMPORTANT SAFEGUARDS

When using electrical appliances, basic safety precautions should always be followed, including the following:

1. **READ ALL INSTRUCTIONS.**
2. Do not touch hot surfaces. Use handles or dials.
3. To protect against fire, electric shock and injury to persons do not immerse cord, plug in water or other liquid.
4. Close supervision is necessary when any appliance is used by or near children.
5. Unplug from outlet when not in use and before cleaning. Allow to cool before inserting or removing parts and before cleaning the appliance.
6. Do not operate any appliance with a damaged cord or plug or after the appliance malfunctions, or has been damaged in any manner. Return appliance to the nearest authorized service facility for examination, repair or adjustment.
7. The use of accessory attachments not recommended by the appliance manufacturer may cause injuries.
8. Do not use outdoors.
9. Do not let cord hang over edge of table or counter, or touch hot surfaces.
10. Do not place on or near a hot gas or electric burner, or in a heated oven.
11. Do not use the kettle for any purpose other than heating water. Do not place any utensils into the kettle.
12. To disconnect, turn the control knob to "OFF", then remove the plug from the wall outlet.
13. After unpacking the appliance, be sure to dispose carefully of the plastic bags so that children or the infirm cannot reach them.
14. Ensure that your mains supply voltage is the same as that marked on the underside of your kettle.
15. Take care when pouring - do not over-fill the kettle as water may enter into the switch mechanism.
16. Do not allow the mains lead to hang over the edge of the table or work surface, or anywhere it may be accidentally caught or tripped over.
17. Remove the kettle from its power base before filling.
18. Never move the kettle while it is in use.
19. Do not use the kettle if you have wet hands.
20. Position the kettle properly on the power base before switching on.
21. Use the kettle properly on the power base before switching on.

## 22. LID OPERATION:

- Press down lid until "click" for a correct engagement, as shown in fig. A.
- Wait until kettle has cooled down and pull up to remove lid, as shown in fig. B.

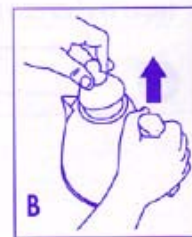



### 23. TO PREVENT SCALDING:

- Never use the kettle without its lid.
- Do not remove the lid while the kettle is boiling.
- Water can remain hot for a long time after boiling and can present a scalding hazard. Keep the kettle and the mains lead away from the edge of the work surface and out of the reach of children, do not remove the lid until the kettle is cool down.

**THIS PRODUCT IS FOR HOUSEHOLD USE ONLY**

## SAVE THESE INSTRUCTIONS

### NOTE:

- This appliance has a polarized plug (one blade is wider than the other). To reduce the risk of electric shock, this plug is intended to fit into a polarized outlet only one way. If the plug does not fit fully into the outlet, reverse the plug. If it still does not fit, contact a qualified electrician. Do not attempt to modify the plug in any way.

- DETACHABLE BASE MUST BE USED ONLY WITH ELECTRIC KETTLE TYPE: DK...

### • SHORT CORD INSTRUCTIONS

- A short power cord is provided to reduce risks resulting from becoming entangled in or tripping over a longer cord.
- Longer, detachable power supply cords or extension cords are available and may be used if care is exercised in their use.
- If an extension cord is used, the marked electrical rating should be at least as great as the electrical rating of the appliance. If the appliance is provided with 3 wire grounded type cord, the extension should be a GROUNDING TYPE 3-WIRE CORD. The longer cord should be arranged so that it will not drape over the counter-top or table top where it can be pulled on by children or tripped over.
- Your product is equipped with a polarized alternating current line plug (a plug having one blade wider than the other). This plug will fit into the power outlet only one way. This is a safety feature. If you are unable to insert the plug fully into the outlet, try reversing the plug. If the plug should still fail to fit, contact your electrician to replace your obsolete outlet. Do not defeat the safety purpose of the polarized plug.



## BEFORE FIRST USE

- Remove all packaging from the kettle and power base.
- Remove any labels from the outer stainless steel surfaces.
- Remove the filter (fig. 1) and wash with water (fig. 2). Refer to page 7. "Removing the scale filter".
- Fill the kettle and boil.
- The boiled water should be discarded and the kettle rinsed out with cold water. This procedure should be carried out three times, to remove any manufacturing dust, etc.
- After the kettle has been rinsed out, re-fit the filter (fig. 3).

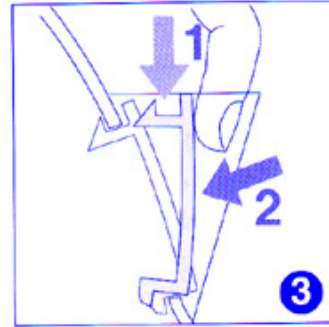
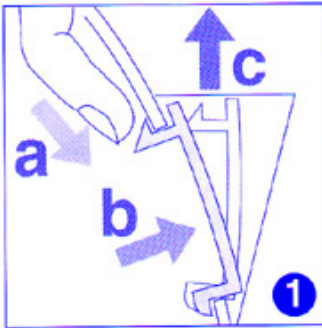

## IN USE

### Power base with 360° access

With the specially designed power base and central connector, you can now set the kettle on the base at any angle, from any position.

- Release cord from storage base and adjust length by winding around the base to give the correct cord length to reach the plug socket to be used (fig. 4).
- Do not leave loose cord hanging over the edge of work surfaces.

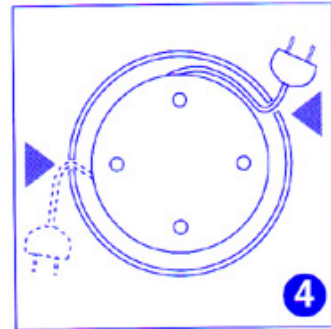

### Filling

- Remove the kettle from the base unit before filling.
- Open lid and fill kettle to desired level.

**Do not fill with less than 0.25 litre or 1 cup of water** to prevent the kettle running dry while operating; misuse of this kind will shorten the life of the element.

**Do not fill with more than 1.7 liters or 7 cups of water** (up to the MAX indication located inside the kettle) (fig. 5). **If the kettle is overfilled, there is a risk that boiling water may be ejected causing burns.**

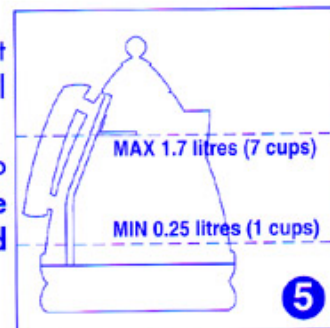



## Switching on

- Plug the power base into the mains socket.
- Place kettle on power base.
- Press the ON/OFF switch down (fig. 6) to switch the kettle on.
- The pilot lights will switch on.
- The kettle will automatically switch off once the water is boiled (the ON/OFF switch will click upwards and the lights will go out).
- To turn the kettle off before the water boils, you may move the ON/OFF switch up to the OFF position, or simply lift the kettle from its base - it will switch off and the switch will return to the OFF position automatically.

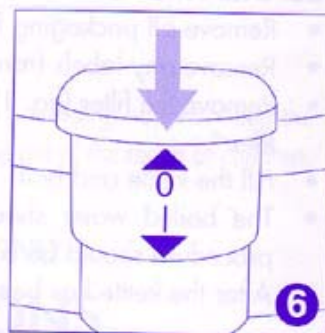

## Pouring

- Remove the kettle from the power base and carefully pour out the water. Do not tilt kettle suddenly or pour out at too sharp an angle.
- When you lift the kettle from the base, you may see moisture on the top surface of the base. This is condensation from the steam that causes the kettle to turn off automatically after boiling. Steam is allowed to escape via vents in the underside of the kettle. **Condensation on the base is perfectly normal, and should not be a cause for alarm.**

## SAFETY DEVICES

### 1) Automatic ON/OFF switch

Your kettle is fitted with an ON/OFF switch which automatically switches off once the water has boiled. If the kettle has just boiled, wait a minute or so before re-boiling the kettle. **Do not attempt to hold the ON/OFF switch in the ON position or adjust the switch mechanism.**

### 2) Safety cut-out

If the kettle is switched ON with too little or no water, it is protected against damage by a safety cut-out which will switch off the power.

If this cut-out operates, disconnect the kettle from the mains supply and **leave to cool down** before refilling with cold water (otherwise the element could be damaged).

3) If kettle is lifted from base while operating (ON), it will automatically switch off.

## CARE AND MAINTENANCE

### Cleaning the kettle

- Allow the kettle to cool down fully and disconnect the appliance from the mains before cleaning.
- Do not immerse the kettle or base in water.
- Use a soft dampened cloth to wipe the outside of the kettle and dry with a soft, dry cloth.
- **DO NOT** use metal polish or harsh scouring agents.
- Ensure that all connectors and sockets are kept dry.

### Scale

Scale is mainly calcium carbonate (chalk), a harmless, naturally occurring mineral found in most water supplies. "Hard" water contains more of this mineral than "soft" water.

When water is heated, the minerals in the water solidify, making the water appear cloudy. These



minerals form a thin film on the walls, element and on the surface of the water. The water may look like it has white colored pieces of plastic floating on the surface.

On traditional kettle elements, scale forms a hard white "crust" which adversely affects performance and reduces the life of the element.

As soon as you notice a film forming on the water, or, when cleaning the filter, if you notice a film on the walls or the element, simply rinse the kettle and wipe it out.

### **Scale filter**

Your kettle is fitted with a scale filter to prevent loose particles of scale being poured into your beverage. This filter is both removable and washable.

The frequency with which you will need to clean any scale deposits from your filter will depend on the hardness of water in your area and how often you use the kettle.

You should remove and clean the water filter when you notice any deposits being left on the filter or if the pouring efficiency is impaired.

### **Removing the scale filter**

- Allow the kettle to cool down fully.
- Disconnect the appliance from the mains electrical supply.
- Make sure that your hands are clean and free from soap, cream or anything which might taint the water.
- Empty the kettle and remove the filter as follows (fig. 1)
- Remove the filter.
- Rinse under a tap while brushing with a soft brush (fig. 2).
- Replace the filter (fig. 3).

### **Removing the scale filter**

- Allow the kettle to cool down fully.
- Disconnect the appliance from the mains electrical supply.
- Make sure that your hands are clean and free from soap, cream or anything which may taint the water.
- Empty the kettle and remove the filter, as indicated below (Fig. 1).
- Remove the filter.
- Rinse under running water, while brushing with a soft brush (Fig. 2).
- Replace the filter (Fig. 3).

### **Cleaning, removing the scale**

The appliance must be cleaned and the scale removed regularly, in order to maintain correct operation.

- Use a suitable scale-remover, for example citric acid crystals.  
The citric acid crystals should be used as follows:
- Pour into kettle about 50 gr. or 2 oz. of citric acid crystal (found in most drugstores), and then fill with water up to the max level indicated and then boil. Allow the contents to cool, and then rinse thoroughly.
- Do not use higher concentration solutions. If scale needs to be removed from the filter, take the filter out and immerse it in the same citric acid solution.
- Make sure the electrical parts are completely dry before operating the kettle.



De'Longhi

## LIMITED WARRANTY

**What Does This Warranty Cover?** We warrant each appliance to be free from defects in material and workmanship. Our obligation under this warranty is limited to replacement or repair, free of charge at our factory or authorized service centers, of any defective part or parts thereof other than parts damaged in transit, which shall be returned to us, transportation prepaid. This warranty shall apply only if the appliance is used in accordance with the factory directions which accompany it, and on an Alternating Current (AC) circuit.

**How Long Does The Coverage Last?** This warranty runs for one year from the date of delivery and applies only to the original purchaser.

**What Does This Warranty Not Cover?** This warranty does not cover defects or damage of the appliance which result from repairs or alterations to the machine outside our factory or authorized service centers, nor shall it apply to any appliance which has been subject to abuse, misuse, negligence or accidents. Also, consequential and incidental damages resulting from the use of this product or arising out of any breach of contract or breach of this warranty are not recoverable under this warranty. Some states do not allow the exclusion or limitation of incidental or consequential damages, so the above limitation may not apply to you.

**How Do You Get Service?** If repairs become necessary or spare parts are needed, please write to:

**De'Longhi America Inc.**  
Park 80 West Plaza One, 4th floor  
Saddle Brook N.J. 07663  
or call Service Tel. No. 001-201-909-4000

The above warranty is in lieu of all other express warranties and representations; All implied warranties are limited to the applicable warranty period set forth above. This limitation does apply if you enter into an extended warranty with De'Longhi. Some states do not allow limitations on how long an implied warranty lasts, so the above exclusions connection with the sale or use of its appliance.

**How Does State Law Apply?** This warranty gives you specific legal rights, and you may also have other rights which vary from state to state.



## Free Manuals Download Website

<http://myh66.com>

<http://usermanuals.us>

<http://www.somanuals.com>

<http://www.4manuals.cc>

<http://www.manual-lib.com>

<http://www.404manual.com>

<http://www.luxmanual.com>

<http://aubethermostatmanual.com>

Golf course search by state

<http://golfingnear.com>

Email search by domain

<http://emailbydomain.com>

Auto manuals search

<http://auto.somanuals.com>

TV manuals search

<http://tv.somanuals.com>